



R&E International

A Subsidiary of Microchip Technology Inc.

RE46C127

CMOS Ionization Smoke Detector ASIC with Interconnect and Timer Mode
Product Specification

General Description

The RE46C127 is low power CMOS ionization type smoke detector IC. With few external components this circuit will provide all the required features for an ionization type smoke detector.

An internal oscillator strobes power to the smoke detection circuitry for 10.5mS every 1.66 seconds to keep standby current to a minimum. A check for a low battery condition is performed every 40 seconds when in standby. A 2/3 duty cycle continuous horn pattern is used for the alarm condition.

An interconnect pin allows multiple detectors to be connected such that when one units alarms all units will sound.

An internal 8 minute timer allows for a separate button to be used for reduced sensitivity mode.

Although this device was designed for smoke detection utilizing an ionization chamber it could be used in a variety of security applications.

The RE46C127 is recognized by Underwriters Laboratories for use in smoke detectors that comply with specification UL217 and UL268.

Features

- Guard Outputs for Ion Detector Input
- +/-0.75pA Detect Input Current
- Internal Reverse Battery Protection
- Low Quiescent Current Consumption (<6.5uA)
- Available in 16L PDIP or 16L N SOIC
- ESD Protection on all Pins
- Internal Low Battery Detection
- Interconnect up to 40 Detectors
- 8 Minute Timer for Sensitivity Control
- Compatible with Allegro A5348
- UL Recognized per File S24036
- Available in Standard Packaging or RoHS Compliant Pb Free Packaging.

Pin Configuration

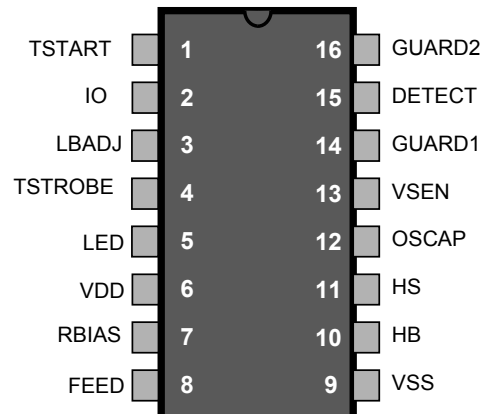

ABSOLUTE MAXIMUM RATINGS

PARAMETER	SYMBOL	VALUE	UNITS
Supply Voltage	V_{DD}	15	V
Input Voltage Range Except FEED, IO	V_{in}	-3 to $V_{dd} + .3$	V
FEED Input Voltage Range	V_{infd}	-10 to +22	V
IO Input Voltage Range	V_{io1}	-.3 to 17	V
Reverse Battery Time	T_{RB}	5	S
Input Current except FEED	I_{in}	10	mA
Operating Temperature	T_A	-10 to 60	°C
Storage Temperature	T_{STG}	-55 to 125	°C
Maximum Junction Temperature	T_J	150	°C

Stresses beyond those listed under Absolute Maximum Ratings may cause permanent damage to the device. These are stress ratings only and operation at these conditions for extended periods may affect device reliability.

This product utilizes CMOS technology with static protection; however proper ESD prevention procedures should be used when handling this product. Damage can occur when exposed to extremely high static electrical charge.

RE46C127

CMOS Ionization Smoke Detector ASIC with
Interconnect and Timer Mode
Product Specification



R&E International
A Subsidiary of Microchip Technology Inc.

DC Electrical Characteristics at TA = 25°C, VDD=9V, OSCAP=.1uF, RBIAS=8.2MΩ, VSS=0V (unless otherwise noted)

Parameter	Symbol	Test Pin	Test Conditions	Limits			
				Min	Typ	Max	Units
Supply Voltage	V _{DD}	6	Operating	6		12	V
Supply Current	I _{DD1}	6	RBIAS=8.2MΩ, OSCAP=.1uF		4	6.5	uA
	I _{DD2}	6	RBIAS=8.2MΩ, OSCAP=.1uF;Vdd=12V			9	uA
Input Voltage High	V _{IH1}	8		6.2	4.5		V
	V _{IH2}	2	No Local Alarm, IO as an Input	3			V
	V _{IH3}	1		4.5			V
Input Voltage Low	V _{IL1}	8			4.5	2.7	V
	V _{IL2}	2	No Local Alarm, IO as an Input			1	V
	V _{IL3}	1				2.5	V
Input Leakage Low	I _{LDET1}	15	VDD=9V, DETECT=VSS, 0-40% RH			-0.75	pA
	I _{LDET2}	15	VDD=9V, DETECT=VSS, 85% RH Note 1			-1.50	pA
	I _{LFD}	8	FEED=-10V			-50	uA
Input Leakage High	I _{HDET1}	15	VDD=9V, DETECT=VDD, 0-40% RH			0.75	pA
	I _{HDET2}	15	VDD=9V, DETECT=VDD, 85% RH Note 1			1.50	pA
	I _{HFD}	8	FEED=22V			50	uA
	I _{IOL2}	2	No Alarm, Vio=17V			150	uA
Output Off Leakage High	I _{IOHZ}	4,5	Outputs Off			1	uA
Input Pull Down Current	I _{PD1}	1	TSTART=9V	20	50	80	uA
Output High Voltage	V _{OH1}	10,11	IOH=-16mA, VDD=7.2V	6.3			V
Output Low Voltage	V _{OL1}	10,11	IOL=16mA, VDD=7.2V			.9	V
	V _{OL2}	4	IOL=500ua			.5	V
	V _{OL3}	5	IOL=10mA, VDD=7.2V			1	V
Output Current	I _{IOL1}	2	No Alarm, Vio=Vdd-2V	25		60	uA
	I _{IOH1}	2	Alarm, Vio=Vdd-2V or Vio=0V	-4		-16	mA
	I _{IODMP}	2	At Conclusion of Local Alarm or Test, Vio=1V	5			mA
Low Battery Voltage	V _{LB}	6	TA=-10 to 60°C, Note 3	7.2	7.5	7.8	V
Internal Sensitivity Set Voltage	V _{SET1}	13		48.5	50	51.5	%V _{DD}
	V _{SET2}	3			65.5		%V _{DD}

RE46C127

CMOS Ionization Smoke Detector ASIC with
Interconnect and Timer Mode
Product Specification



R&E International
A Subsidiary of Microchip Technology Inc.

DC Electrical Characteristics - Continued

Parameter	Symbol	Test Pin	Test Conditions	Limits			
				Min	Typ	Max	Units
Offset Voltage	V _{OS1}	14,15	Guard Amplifier	-50		50	mV
	V _{OS2}	15,16	Guard Amplifier	-50		50	mV
	V _{OS3}	14,15	Smoke Comparator	-50		50	mV
Common Mode Voltage	V _{CM1}	14,15	Guard Amplifier, Note 2	2		V _{DD} -5	V
	V _{CM2}	13,15	Smoke Comparator, Note 2	.5		V _{DD} -2	V
Output Impedance	Z _{OUT}	14,16	Guard Amplifier Outputs, Note 2		10		kΩ
Hysteresis	V _{HYS}	13	No Alarm to Alarm Condition	90	130	170	mV

Note 1: Sample test only

Note 2: Not 100% production tested

Note 3: Production test at room with temperature guardbanded limits.

AC Electrical Characteristics at TA = 25°C, VDD=9V, OSCAP=.1uF, RBIAS=8.2MΩ, VSS=0V (unless otherwise noted)

Parameter	Symbol	Test Pin	Test Conditions	Limits			
				Min	Typ	Max	Units
Oscillator Period	T _{PER1}	12	No Alarm Condition	1.34	1.67	2	S
	T _{PER2}	12	Alarm Condition	37.5	41.5	45.8	mS
Oscillator Pulse Width	T _{PW}	5	Operating	9.4	10.5	12.9	mS
LED On Time	T _{LON}	5	Operating	9.4	10.5	12.9	mS
LED Off Time	T _{LOF1}	5	Standby, No Alarm	32	40	48	S
	T _{LOF2}	5	Alarm Condition	.8	1	1.2	S
	T _{LOF3}	5	Timer Mode, No Alarm	8	10	12	S
Horn On Time	T _{HON1}	10,11	Operating, Alarm Condition	141	166	190	mS
	T _{HON2}	10,11	Low Battery, No Alarm	9.4	10.5	12.9	mS
Horn Off Time	T _{HOF1}	10,11	Operating, Alarm Condition	71	83	95	mS
	T _{HOF3}	10,11	Low Battery, No Alarm	32	40	48	S
IO Charge Dump Duration	T _{IODMP}	2	At Conclusion of Local Alarm or Test	1.34	1.67	2.0	S
IO Delay	T _{IODLY1}	2	From Start of Local Alarm to IO Active		3		S
IO Filter	T _{IOFILT}	2	IO pulse width guaranteed to be filtered. IO as Input, No Local Alarm			450	mS
Remote Alarm Delay	T _{IODLY2}	2	No Local Alarm, IO as input, From IO active to Horn Active	.450		2.2	S
Timer Period	T _{TPER}	4	No Alarm	6.2	8	9.8	Min

Note 4 – See the timing diagram for complete horn pattern

RE46C127

CMOS Ionization Smoke Detector ASIC with
Interconnect and Timer Mode
Product Specification



R&E International
A Subsidiary of Microchip Technology Inc.

Functional Block Diagram

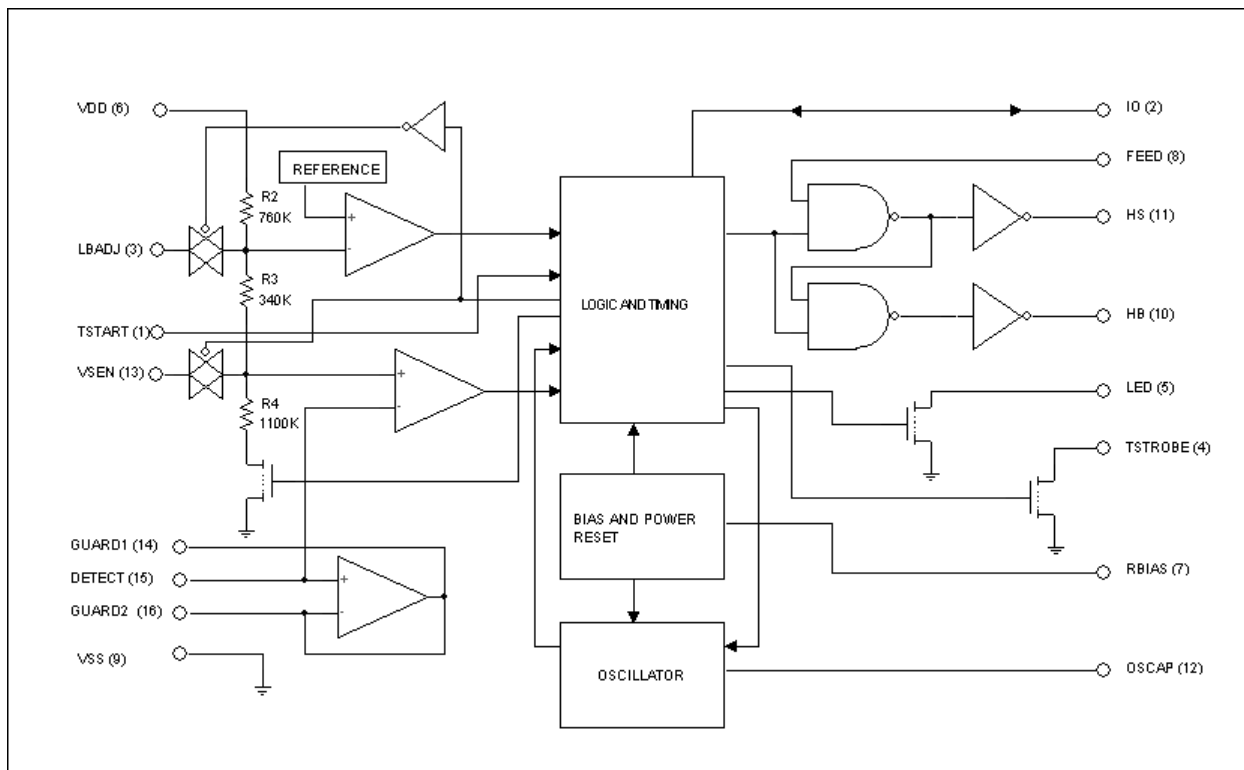

RE46C127

**CMOS Ionization Smoke Detector ASIC with
Interconnect and Timer Mode**
Product Specification



R&E International
A Subsidiary of Microchip Technology Inc.

DEVICE DESCRIPTION and APPLICATION NOTES

Internal Timing – With external components as indicated on the application drawing the period of the oscillator is nominally 1.67 seconds in standby. Every 1.66 seconds the detection circuitry is powered up for 10.5mS and the status of the smoke comparator is latched. In addition every 40 seconds the LED driver is turned on for 10.5mS and the status of the low battery comparator is latched. The smoke comparator status is not checked during the low battery test, during the low battery horn warning chirp, or when the horn is on due to an alarm condition.

If an alarm condition is detected the oscillator period increases to 41.5mS.

Due to the low currents used in the oscillator the capacitor on pin 12 should be a low leakage type. Oscillator accuracy will depend mainly on the tolerance of the RBIAS resistor and OSCAP capacitor.

Smoke Detection Circuit – The smoke comparator compares the ionization chamber voltage to a voltage derived from a resistor divider across VDD. This divider voltage is available externally on pin 13 (VSEN). When smoke is detected this voltage is internally increased by 130mV nominal to provide hysteresis and make the detector less sensitive to false triggering.

Pin 13 (VSEN) can be used to modify the internal set point for the smoke comparator by use of external resistors to VDD or VSS. Nominal values for the internal resistor divider are indicated on the block diagram. These internal resistor values can vary by up to $\pm 20\%$ but the resistor matching should be $< 2\%$ on any one device. Transmission switches on VSEN and LBADJ prevent any interaction from the external adjustment resistors.

The guard amplifier and outputs are always active and will be within 50mV of the DETECT input to reduce surface leakage. The guard outputs also allow for measurement of the DETECT input without loading the ionization chamber.

Low Battery Detection - An internal reference is compared to the voltage divided VDD supply. The battery can be checked under load via the LED low side driver output since low battery status is latched at the end of the 10.5mS LED pulse. Pin 3 (LBADJ) can be used to modify the low battery set point by placing a resistor to VDD or VSS. Transmission switches on VSEN and LBADJ prevent any interaction from external adjustment resistance.

LED Pulse – The LED is pulsed on for 10.5mS every 40S in standby. In alarm the LED is pulsed on for 10.5mS every 1S.

Interconnect – Pin 2 (IO) provides the capability to common many detectors in a single system. If a single unit goes into alarm the IO pin is driven high. This high signal causes the interconnected units to alarm. The LED flashes every 1S for 10.5mS on the signaling unit and is inhibited on the units that are in alarm due to the IO signal. An internal sink device on the IO pin helps to discharge the interconnect line. This charge dump device is active for 1 clock cycle after the unit exits the alarm condition (1.67S).

The interconnect input has a 500mS nominal digital filter. This allows for interconnection to other types of alarms (carbon monoxide for example) that may have a pulsed interconnect signal.

Testing – At power up all internal registers are reset. The low battery set point can be tested at power up by holding FEED and OSCAP low at power up. HB will change state as VDD passes through the low battery set point. By holding pin 12 (OSCAP) low the internal power strobe is active. Functional testing can be accelerated by driving pin 12 with a 4kHz square wave however the 10.5mS strobe period must be maintained for proper operation of the analog circuitry. Please refer to the timing diagrams.

Timer Mode – The transition of pin 1 (TSTART) from a high to low level initiates an 8 minute timer. During this 8 minute nominal period the open drain NMOS on pin 4 (TSTROBE) is strobed on with the internal clock. A resistor connected to this pin could be used to modify the detector sensitivity for the timer period.

RE46C127

CMOS Ionization Smoke Detector ASIC with
Interconnect and Timer Mode
Product Specification



R&E International
A Subsidiary of Microchip Technology Inc.

Typical Application

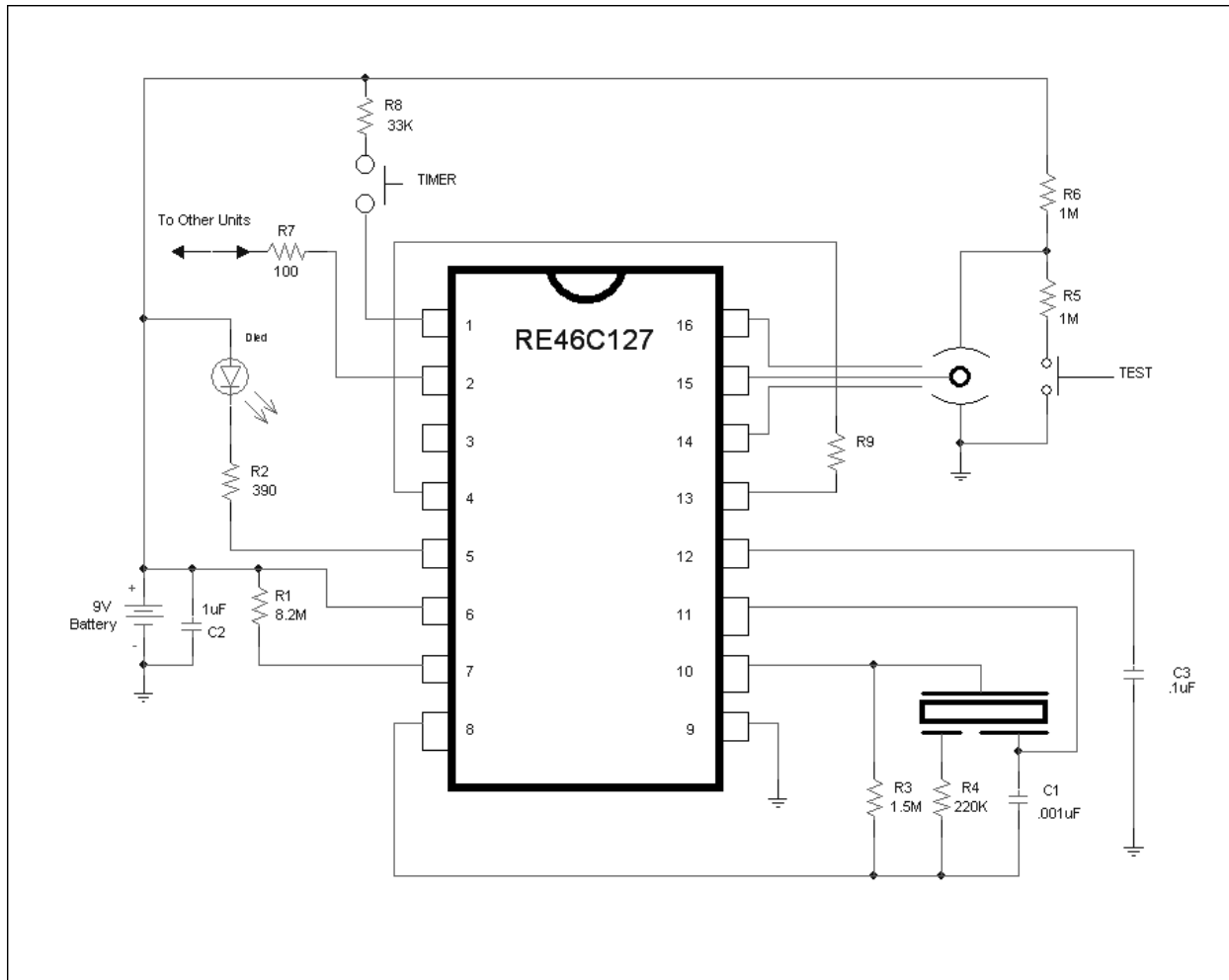

Figure 2

Notes:

Select R9 to reduce sensitivity during the timer mode.

R3, R4 and C1 are typical values and may be adjusted to maximize sound pressure.

C2 should be located as close as possible to the device power pins.

Route the pin 8 PC board trace away from pin 7 to avoid coupling.

RE46C127

CMOS Ionization Smoke Detector ASIC with
Interconnect and Timer Mode
Product Specification



R&E International
A Subsidiary of Microchip Technology Inc.

Typical Single Button Application

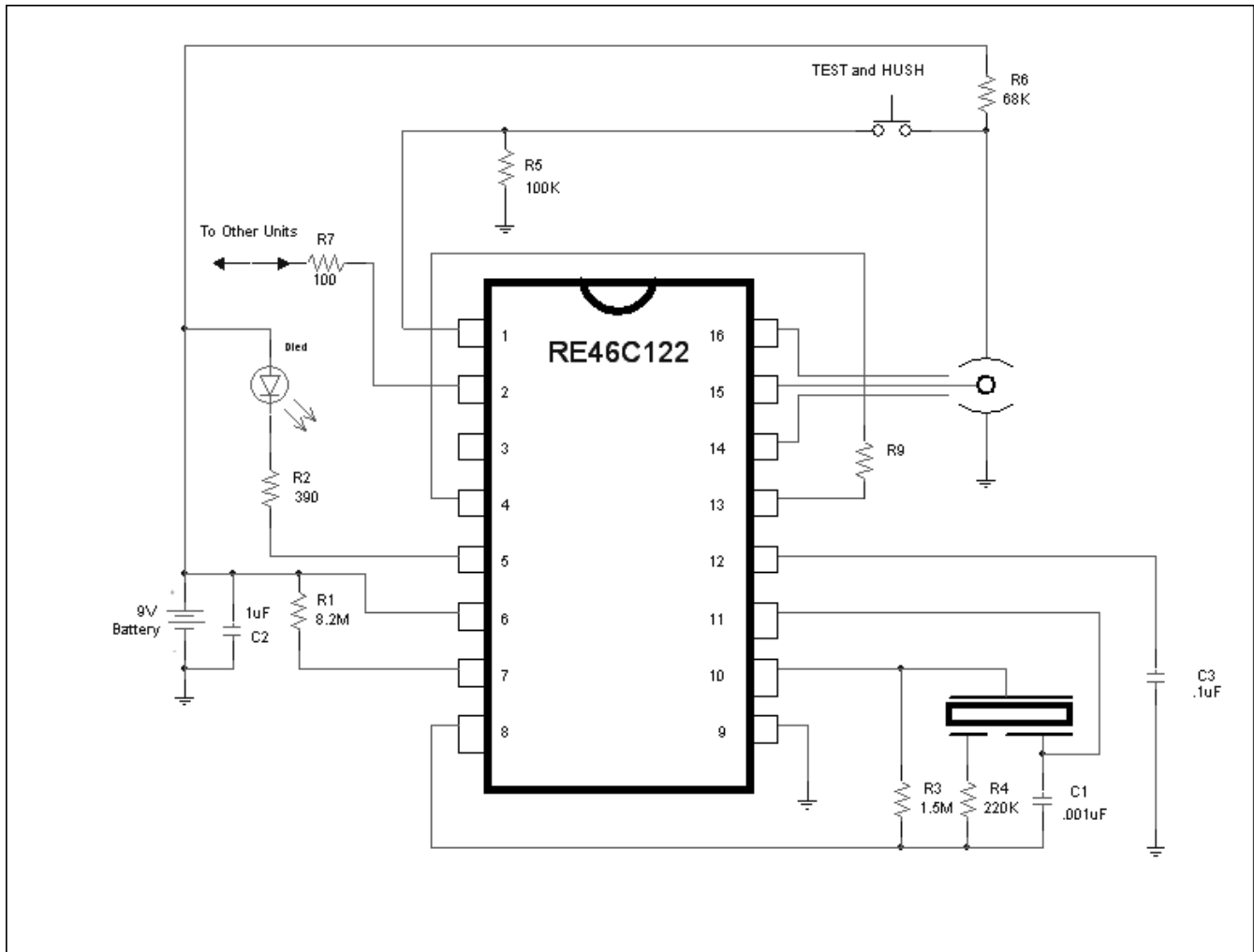

Figure 3

Notes:

Select R5 and R6 for the correct level to test the ion chamber. The voltage level on pin 1 (TSTART) must be greater than the VIH level to initiate the timer. Pin 1 has an internal 180K nominal pull down which must be considered.

Select R9 to reduce sensitivity during the timer mode.

R3, R4 and C1 are typical values and may be adjusted to maximize sound pressure.

C2 should be located as close as possible to the device power pins.

Route the pin 8 PC board trace away from pin 7 to avoid coupling.

RE46C127

CMOS Ionization Smoke Detector ASIC with
Interconnect and Timer Mode
Product Specification



R&E International
A Subsidiary of Microchip Technology Inc.

Timing Diagram (non Timer Mode)

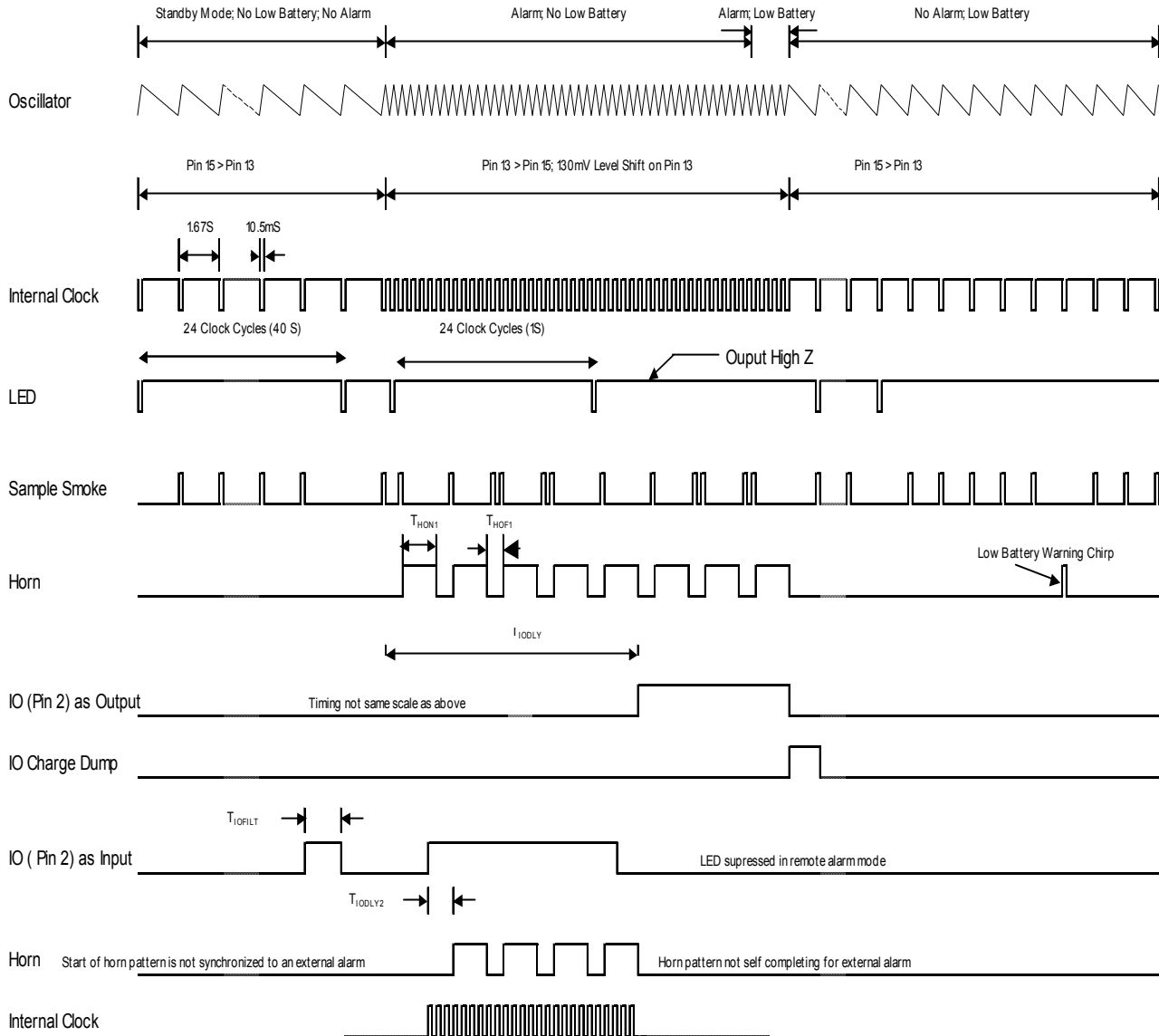

Notes:

- Smoke is not sampled when the horn is active. Horn cycle is self completing in local alarm.
- Low battery warning chirp is suppressed in local or remote alarm
- IO Dump active only in local alarm, inactive if external alarm

RE46C127

CMOS Ionization Smoke Detector ASIC with
Interconnect and Timer Mode
Product Specification



R&E International
A Subsidiary of Microchip Technology Inc.

Timing Diagram (Timer Mode)

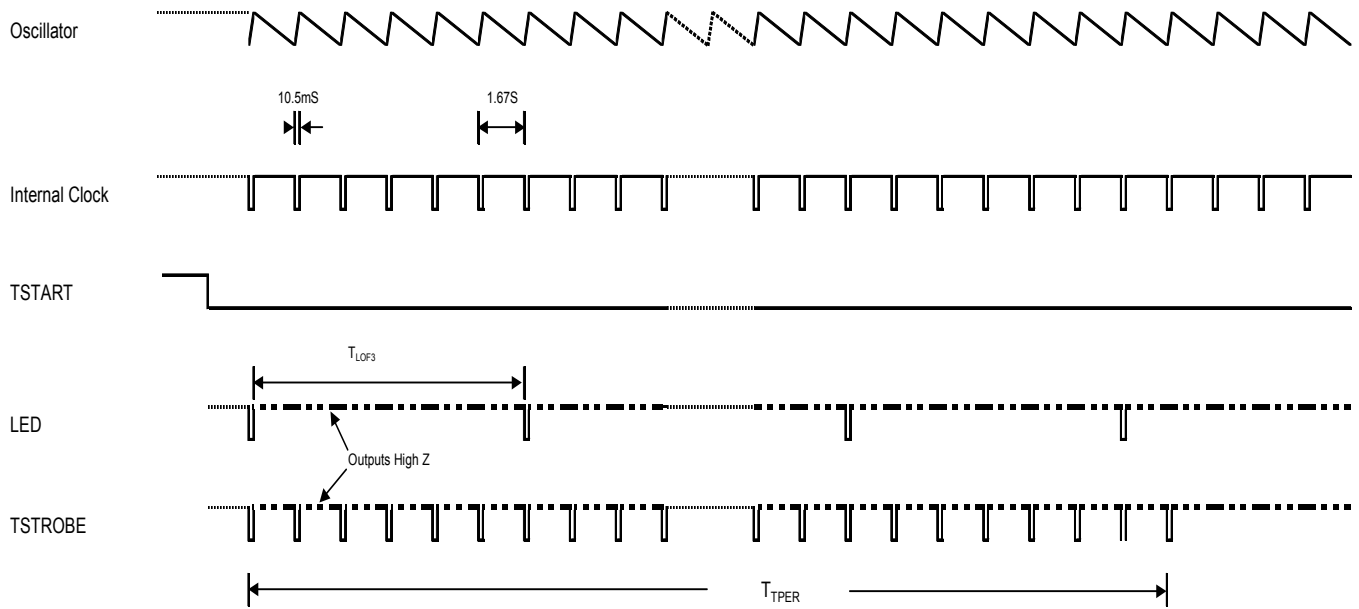

RE46C127

**CMOS Ionization Smoke Detector ASIC with
Interconnect and Timer Mode**
Product Specification



R&E International
A Subsidiary of Microchip Technology Inc.

Information contained in this publication regarding device applications and the like is provided only for your convenience and may be superseded by updates. It is your responsibility to ensure that your application meets with your specifications. MICROCHIP MAKES NO REPRESENTATIONS OR WARRANTIES OF ANY KIND WHETHER EXPRESS OR IMPLIED, WRITTEN OR ORAL, STATUTORY OR OTHERWISE, RELATED TO THE INFORMATION, INCLUDING BUT NOT LIMITED TO ITS CONDITION, QUALITY, PERFORMANCE, MERCHANTABILITY OR FITNESS FOR PURPOSE. Microchip disclaims all liability arising from this information and its use. Use of Microchip devices in life support and/or safety applications is entirely at the buyer's risk, and the buyer agrees to defend, indemnify and hold harmless Microchip from any and all damages, claims, suits, or expenses resulting from such use. No licenses are conveyed, implicitly or otherwise, under any Microchip intellectual property rights.

Trademarks

The Microchip name and logo, the Microchip logo, Accuron, dsPIC, KEELOQ, KEELOQ logo, MPLAB, PIC, PICmicro, PICSTART, rPIC, SmartShunt and UNI/O are registered trademarks of Microchip Technology Incorporated in the U.S.A. and other countries.

FilterLab, Hampshire, Linear Active Thermistor, MXDEV, MXLAB, SEEVAL, SmartSensor and The Embedded Control Solutions Company are registered trademarks of Microchip Technology Incorporated in the U.S.A.

Analog-for-the-Digital Age, Application Maestro, CodeGuard, dsPICDEM, dsPICDEM.net, dsPICworks, dsSPEAK, ECAN, ECONOMONITOR, FanSense, In-Circuit Serial Programming, ICSP, ICEPIC, Mindi, MiWi, MPASM, MPLAB Certified logo, MPLIB, MPLINK, mTouch, nanoWatt XLP, PICkit, PICDEM, PICDEM.net, PICTail, PIC³² logo, PowerCal, PowerInfo, PowerMate, PowerTool, REAL ICE, rLAB, Select Mode, Total Endurance, TSHARC, WiperLock and ZENA are trademarks of Microchip Technology Incorporated in the U.S.A. and other countries.

SQTP is a service mark of Microchip Technology Incorporated in the U.S.A.

All other trademarks mentioned herein are property of their respective companies.

© 2009, Microchip Technology Incorporated, Printed in the U.S.A., All Rights Reserved.

 Printed on recycled paper.

**QUALITY MANAGEMENT SYSTEM
CERTIFIED BY DNV
== ISO/TS 16949:2002 ==**

Microchip received ISO/TS-16949:2002 certification for its worldwide headquarters, design and wafer fabrication facilities in Chandler and Tempe, Arizona; Gresham, Oregon and design centers in California and India. The Company's quality system processes and procedures are for its PIC[®] MCUs and dsPIC[®] DSCs, KEELOQ[®] code hopping devices, Serial EEPROMs, microperipherals, nonvolatile memory and analog products. In addition, Microchip's quality system for the design and manufacture of development systems is ISO 9001:2000 certified.



Компания «ЭлектроПласт» предлагает заключение долгосрочных отношений при поставках импортных электронных компонентов на взаимовыгодных условиях!

Наши преимущества:

- Оперативные поставки широкого спектра электронных компонентов отечественного и импортного производства напрямую от производителей и с крупнейших мировых складов;
- Поставка более 17-ти миллионов наименований электронных компонентов;
- Поставка сложных, дефицитных, либо снятых с производства позиций;
- Оперативные сроки поставки под заказ (от 5 рабочих дней);
- Экспресс доставка в любую точку России;
- Техническая поддержка проекта, помощь в подборе аналогов, поставка прототипов;
- Система менеджмента качества сертифицирована по Международному стандарту ISO 9001;
- Лицензия ФСБ на осуществление работ с использованием сведений, составляющих государственную тайну;
- Поставка специализированных компонентов (Xilinx, Altera, Analog Devices, Intersil, Interpoint, Microsemi, Aeroflex, Peregrine, Syfer, Eurofarad, Texas Instrument, Miteq, Cobham, E2V, MA-COM, Hittite, Mini-Circuits, General Dynamics и др.);

Помимо этого, одним из направлений компании «ЭлектроПласт» является направление «Источники питания». Мы предлагаем Вам помощь Конструкторского отдела:

- Подбор оптимального решения, техническое обоснование при выборе компонента;
- Подбор аналогов;
- Консультации по применению компонента;
- Поставка образцов и прототипов;
- Техническая поддержка проекта;
- Защита от снятия компонента с производства.



Как с нами связаться

Телефон: 8 (812) 309 58 32 (многоканальный)

Факс: 8 (812) 320-02-42

Электронная почта: org@eplast1.ru

Адрес: 198099, г. Санкт-Петербург, ул. Калинина, дом 2, корпус 4, литера А.