

## LOW-NOISE J-FET INPUT OPERATIONAL AMPLIFIERS

### ■ GENERAL DESCRIPTION

The NJM072C/082C/NJM074C/084C are JFET input operational amplifiers. They feature low input bias and offset currents, high input impedance and fast slew rate.

The low harmonic distortion and low noise make them ideally suit for amplifiers with high fidelity and audio amplifier applications.

In addition, the realization of a wide operating temperature reaches by a new design.

### ■ PACKAGE OUTLINE

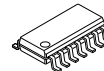

NJM072CG / NJM072CAG  
NJM082CG / NJM082CAG  
Dual (SOP8)

NJM074CG / NJM074CAG  
NJM084CG / NJM084CAG  
Quad (SOP14)

### ■ FEATURES

- Wide power supply range :  $\pm 4$  to  $\pm 18$ V
- Internal ESD protection : Human body model (HBM)  $\pm 2000$ V typ.
- High Input Resistance :  $10^{12}\Omega$  typ.
- Wide temperature range :  $-40^\circ\text{C}$  to  $+105^\circ\text{C}$
- Bipolar Technology
- High Slew Rate :  $13\text{V}/\mu\text{s}$  typ.
- Wide Unity Gain Bandwidth :  $3\text{MHz}$  typ.

### ■ Input Offset Voltage

NJM072C / 074C	NJM072CA / 074CA	NJM082C / 084C	NJM082CA / 084CA
10mV max.	6mV max.	15mV max.	6mV max.

### ■ PIN CONFIGURATION (Top View)

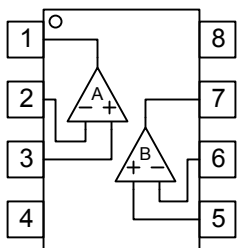

- PIN FUNCTION**
- 1. A OUTPUT
  - 2. A -INPUT
  - 3. A +INPUT
  - 4.  $V^+$
  - 5. B +INPUT
  - 6. B -INPUT
  - 7. B OUTPUT
  - 8.  $V^+$

NJM072C / NJM082C  
NJM072CA / NJM082CA

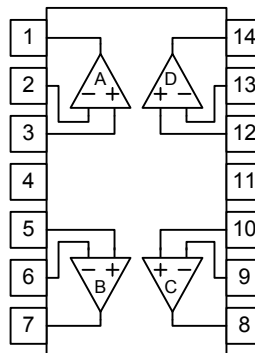

- PIN FUNCTION**
- 1. A OUTPUT
  - 2. A -INPUT
  - 3. A +INPUT
  - 4.  $V^+$
  - 5. B +INPUT
  - 6. B -INPUT
  - 7. B OUTPUT
  - 8. C OUTPUT
  - 9. C -INPUT
  - 10. C +INPUT
  - 11.  $V^-$
  - 12. D +INPUT
  - 13. D -INPUT
  - 14. D OUTPUT

NJM074C / NJM084C  
NJM074CA / NJM084CA

### ■ EQUIVALENT CIRCUIT (Each Amplifier)

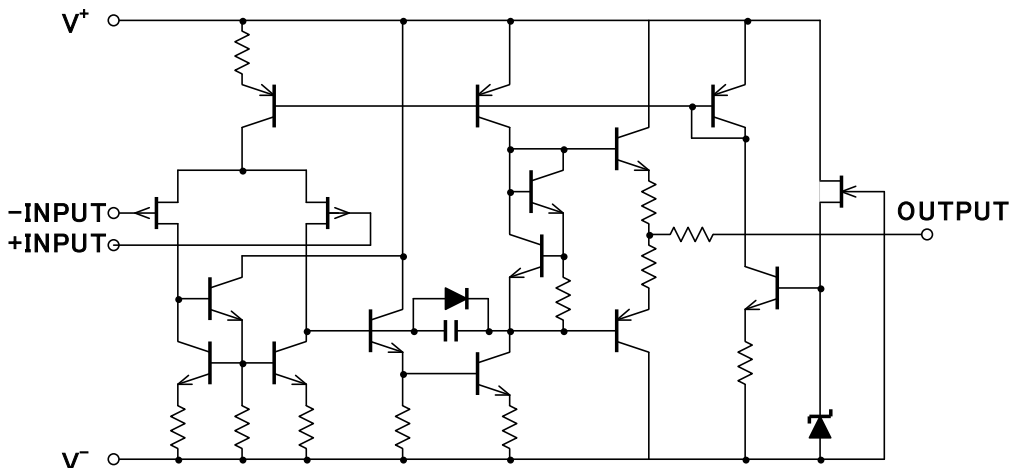

# NJM072C/074C NJM072CA/074CA

# NJM082C/084C NJM082CA/084CA

## ■ ABSOLUTE MAXIMUM RATINGS (Ta=25°C, unless otherwise noted.)

PARAMETER	SYMBOL	RATINGS	UNIT
Supply Voltage	V <sup>+</sup> /V <sup>-</sup>	±18	V
Differential Input Voltage <sup>(1)</sup>	V <sub>ID</sub>	±36	V
Input Voltage <sup>(2)</sup>	V <sub>IN</sub>	V <sup>-</sup> -0.3 to V <sup>+</sup> +36	V
Output Terminal Input Voltage	V <sub>O</sub>	V <sup>-</sup> -0.3 to V <sup>+</sup> +0.3	V
Power Dissipation	P <sub>D</sub>	SOP8 : 690 <sup>(3)</sup> 1000 <sup>(4)</sup> SOP14 : 880 <sup>(3)</sup> 1200 <sup>(4)</sup>	mW
Operating Temperature Range	T <sub>opr</sub>	-40 to +105	°C
Storage Temperature Range	T <sub>stg</sub>	-65 to +150	°C

(1) Differential voltage is the voltage difference between +INPUT and -INPUT.

(2) Input voltage is the voltage should be allowed to apply to the input terminal independent of the magnitude of V<sup>+</sup>.

The normal operation will establish when any input is within the Common Mode Input Voltage Range of electrical characteristics.

(3) EIA/JEDEC STANDARD Test board (76.2 x 114.3 x 1.6mm, 2layers, FR-4) mounting

(4) EIA/JEDEC STANDARD Test board (76.2 x 114.3 x 1.6mm, 4layers, FR-4) mounting

## ■ RECOMMENDED OPERATING CONDITIONS

PARAMETER	SYMBOL	CONDITION	MIN.	TYP.	MAX.	UNIT
Supply Voltage	V <sup>+</sup> /V <sup>-</sup>	Ta=25°C	±4	-	±18	V

## ■ ELECTRICAL CHARACTERISTICS

V<sup>+</sup>/V<sup>-</sup>=±15V, Ta=25°C (unless otherwise noted)

( ) Applies to NJM082,NJM084

PARAMETER	SYMBOL	CONDITION	NJM072C/NJM082C NJM074C/NJM084C			NJM072CA/NJM082CA NJM074CA/NJM084CA			UNIT
			MIN.	TYP.	MAX.	MIN.	TYP.	MAX.	
Input Offset Voltage	V <sub>IO</sub>	R <sub>S</sub> =50Ω Ta=25°C 0°C < Ta < 70°C <sup>(5)</sup>	-	3	10(15) 13(15)	-	3	6(6) 7(7.5)	mV
Input Offset voltage drift	ΔV <sub>IO</sub> /ΔT	R <sub>S</sub> =50Ω 0°C < Ta < 70°C <sup>(5)</sup>	-	18	-	-	18	-	μV/°C
Input Offset Current	I <sub>IO</sub>	Ta=25°C 0°C < Ta < 70°C <sup>(5)</sup>	-	5	50(200) 10	-	5	50(100) 2	pA nA
Input Bias Current	I <sub>B</sub>	Ta=25°C 0°C < Ta < 70°C <sup>(5)</sup>	-	30	200(400) 7	-	30	200 7	pA nA
Input Resistance	R <sub>IN</sub>		-	10 <sup>12</sup>	-	←	←	←	Ω
Open Loop Gain	A <sub>V</sub>	R <sub>L</sub> ≥2kΩ, V <sub>O</sub> =±10V Ta=25°C 0°C < Ta < 70°C <sup>(5)</sup>	25 15	200 -	- -	50 25	200 -	- -	V/mV
Maximum Output Voltage Swing	V <sub>OM</sub>	R <sub>L</sub> =10kΩ Ta=25°C 0°C < Ta < 70°C <sup>(5)</sup> R <sub>L</sub> =2kΩ 0°C < Ta < 70°C <sup>(5)</sup>	±12 ±12	±135 -	- -	← ←	← ←	← ←	V
Input Common Mode Voltage Range	V <sub>ICM</sub>	≥CMR MIN	±11	-12 to 15	-	←	←	←	V
Common Mode Rejection Ratio	CMR	V <sub>ICM</sub> =V <sub>ICMmin</sub> , R <sub>S</sub> ≤10kΩ	70	100	-	75	100	-	dB
Supply Voltage Rejection Ratio	SVR	V <sup>+</sup> /V <sup>-</sup> =±9V to ±15V R <sub>S</sub> ≤10kΩ	70	100	-	80	100	-	dB
Operating Current	I <sub>CC</sub>	No signal each amplifier	-	1.4	2.5(2.8)	←	←	←	mA
Slew rate	SR	V <sub>IN</sub> =10Vpp, R <sub>L</sub> =2kΩ, C <sub>L</sub> =100pF See Figure1	8	13	-	←	←	←	V/μs
Unity Gain Frequency	f <sub>T</sub>		-	3	-	←	←	←	MHz

# NJM072C/074C NJM072CA/074CA NJM082C/084C NJM082CA/084CA

PARAMETER	SYMBOL	CONDITION	NJM072C/NJM082C NJM074C/NJM084C			NJM072CA/NJM082CA NJM074CA/NJM084CA			UNIT
			MIN.	TYP.	MAX.	MIN.	TYP.	MAX.	
Rise time	$t_r$	$V_{IN}=20mV_{pp}$ , $R_L=2k\Omega$ , $C_L=100pF$ See Figure1	-	0.1	-	←	←	←	us
Overshoot factor	$K_{OV}$	$V_{IN}=20mV_{pp}$ , $R_L=2k\Omega$ , $C_L=100pF$ See Figure1	-	20	-	←	←	←	%
Total Harmonic Distortion	THD	$V_{IN}=6V_{rms}$ , $G_v=0dB$ $R_L=2k\Omega$ , $R_S=1k\Omega$ , $f=1kHz$	-	0.003	-	←	←	←	%
Equivalent Input Noise Voltage1	$V_{NI}$	$R_S=20\Omega$ , $f=10Hz$ to $10kHz$	-	4	-	←	←	←	$\mu V_{rms}$
Equivalent Input Noise Voltage2	$e_n$	$R_S=20\Omega$ , $f=1kHz$	-	18	-	←	←	←	$nV/\sqrt{Hz}$
Equivalent Input Noise Current	$i_n$	$R_S=20\Omega$ , $f=1kHz$	-	0.01	-	←	←	←	$pA/\sqrt{Hz}$
Channel Separation	CS	$G_v=40dB$	-	120	-	←	←	←	dB

(5) This parameter is not 100% test.

## ■ MEASUREMENT CIRCUITS

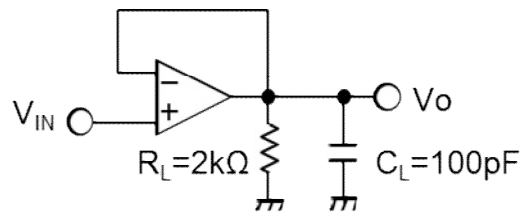

Figure1. Voltage Follower

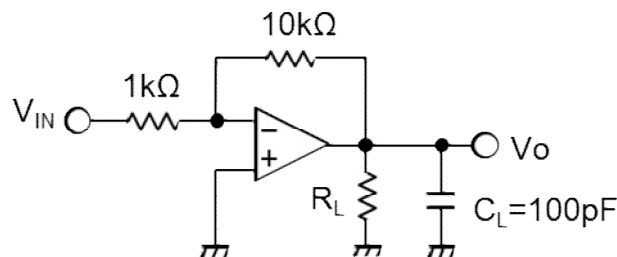
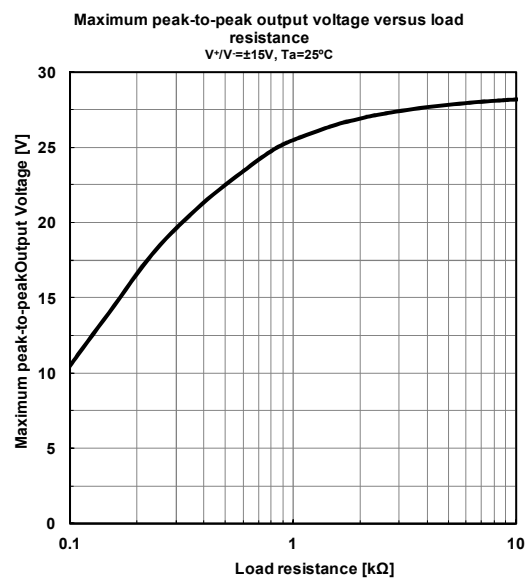
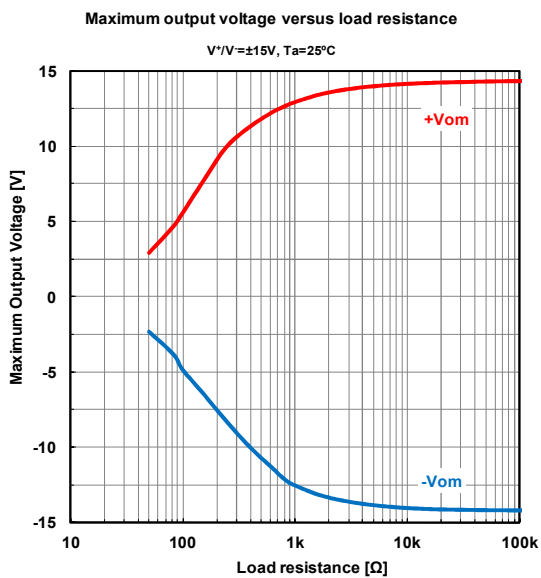
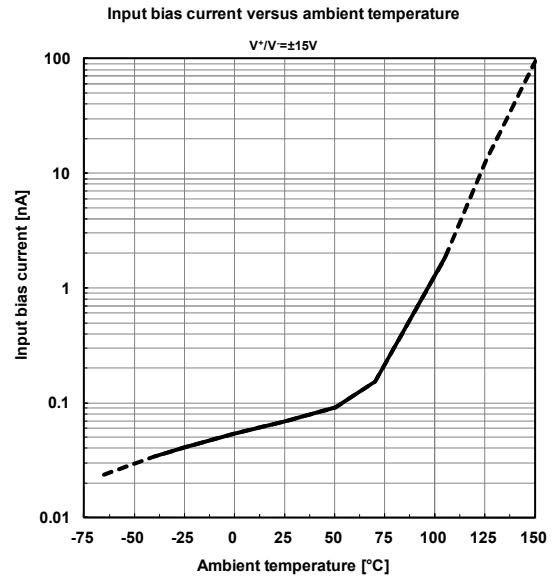
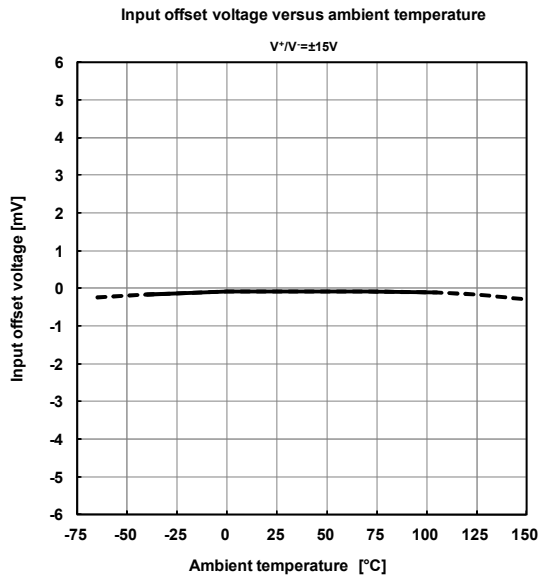
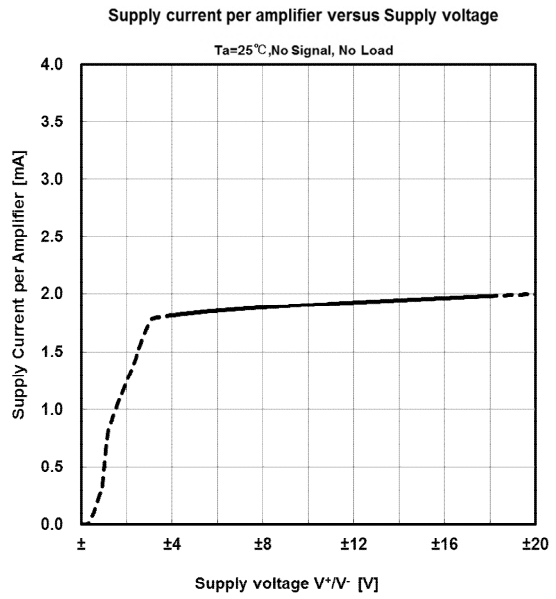
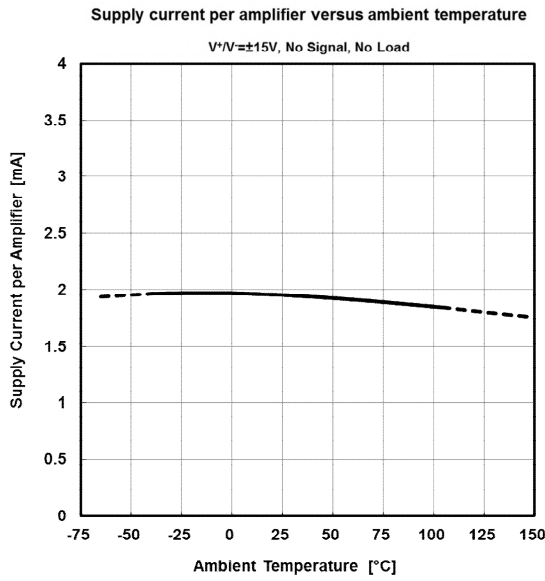

Figure2. 20dB Inverting Amplifier (\*)

(\*) 20dB Inverting Amplifier uses a Maximum Output Voltage vs. Frequency on page 5 and 6.

## ■ TYPICAL CHARACTERISTICS



## ■ TYPICAL CHARACTERISTICS

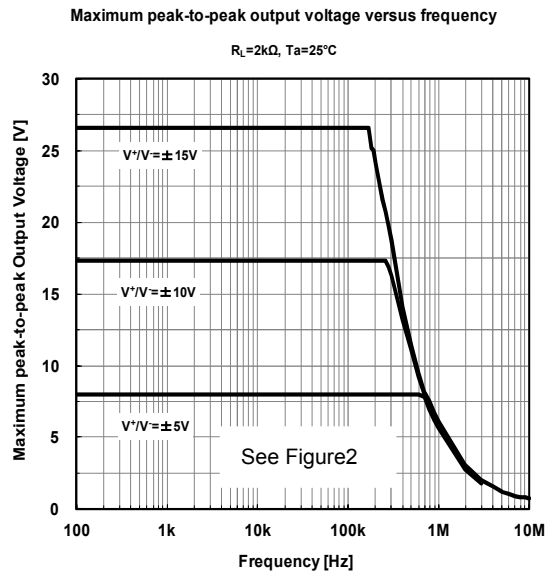
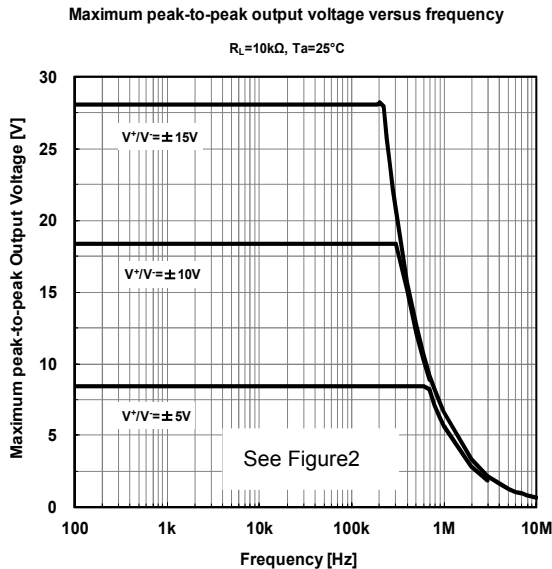
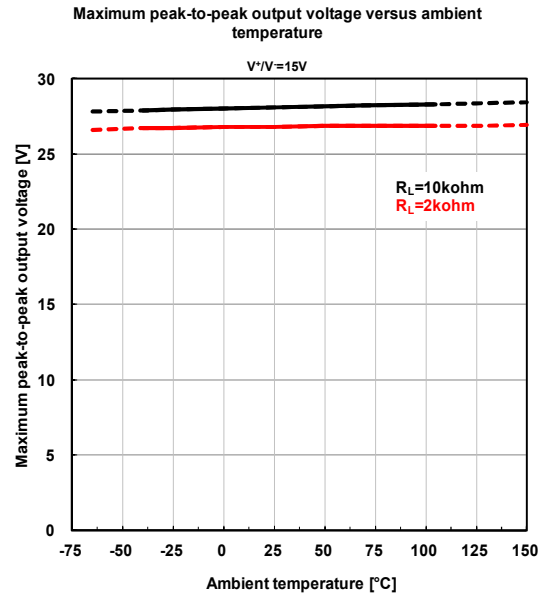
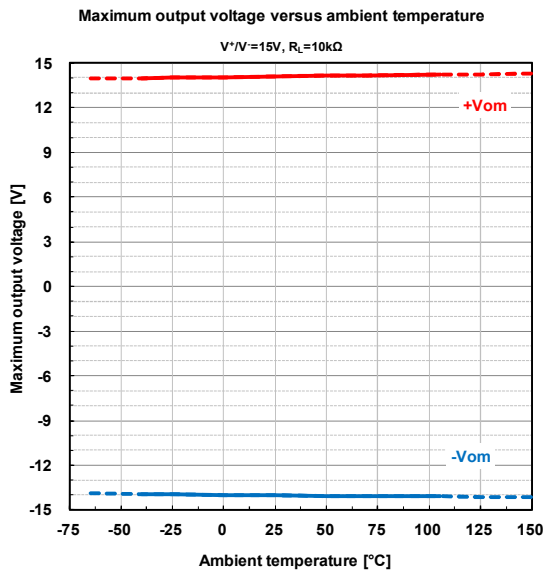
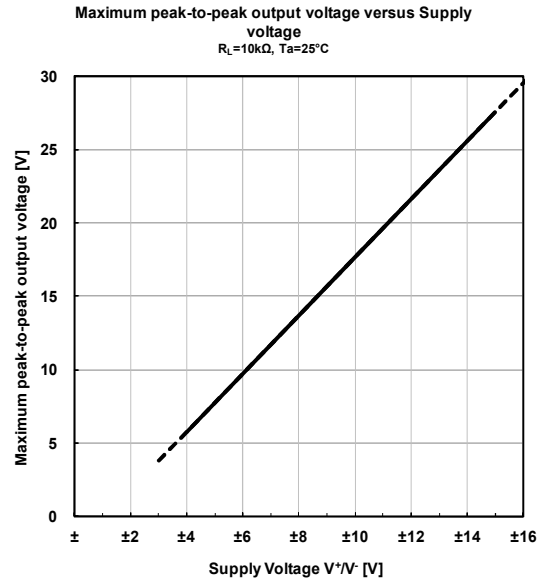
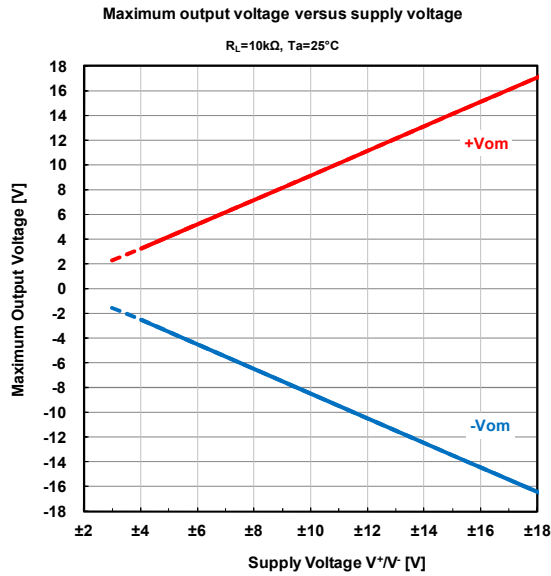

## ■ TYPICAL CHARACTERISTICS

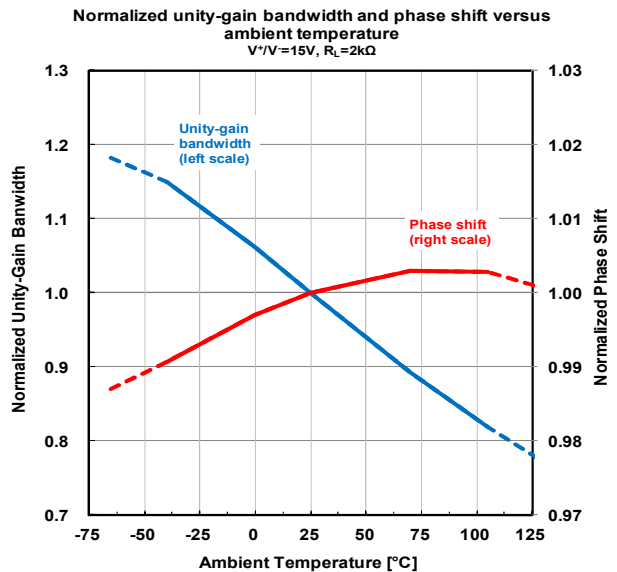
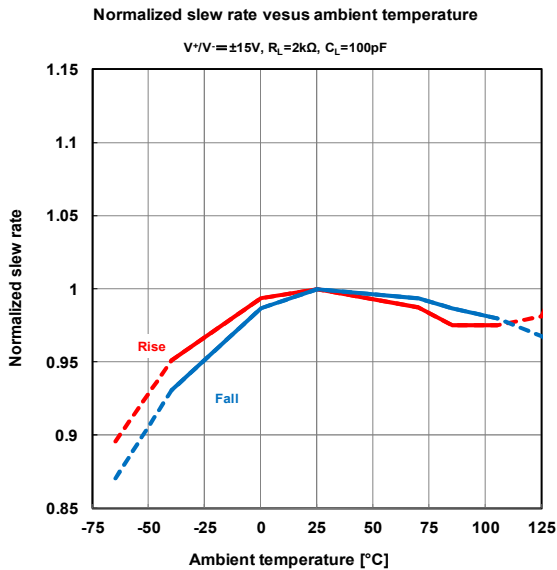
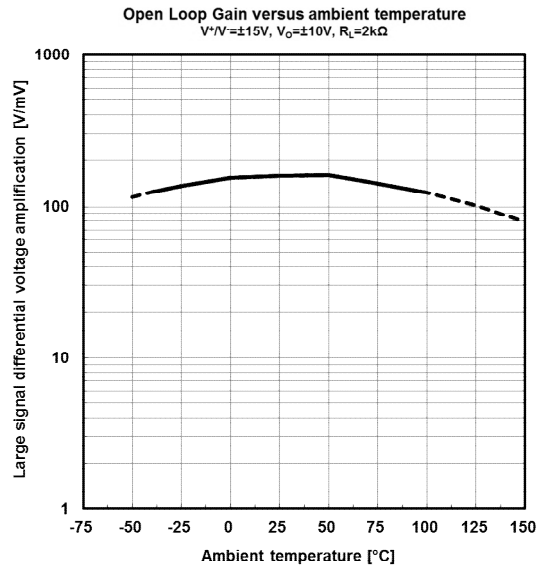
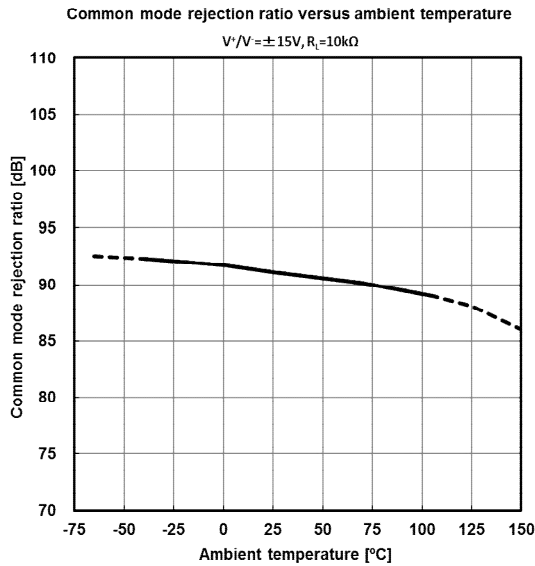
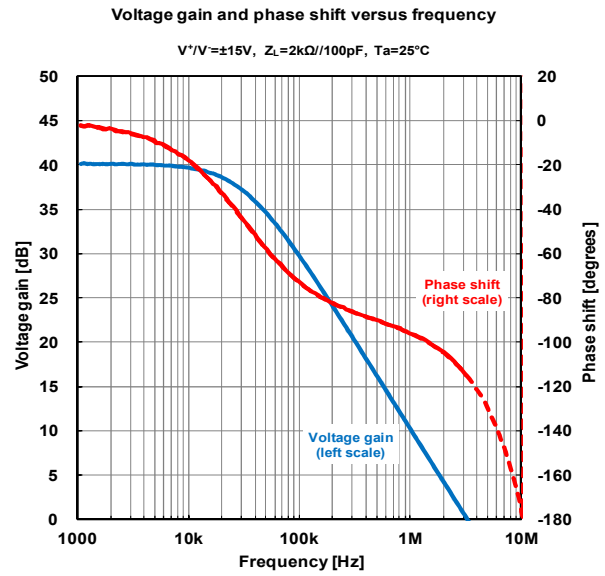
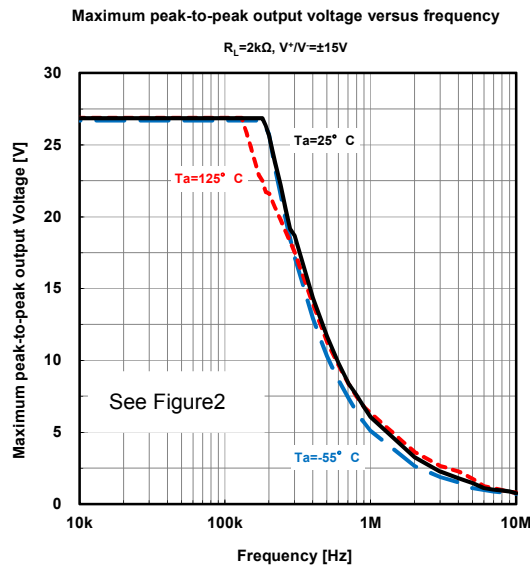

■ TYPICAL CHARACTERISTICS

Voltage follower large signal pulse response

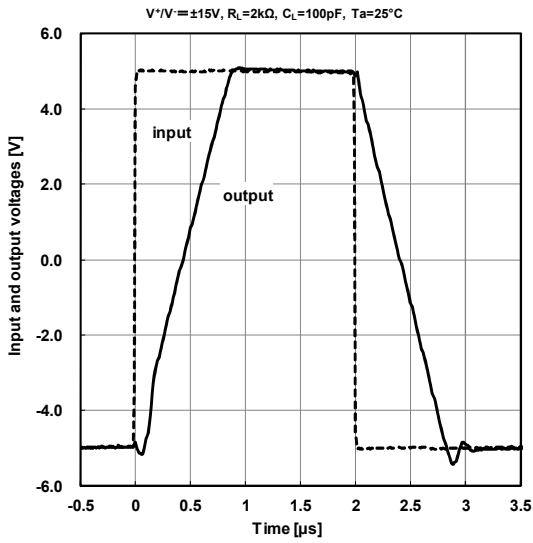

Output voltage versus elapsed time

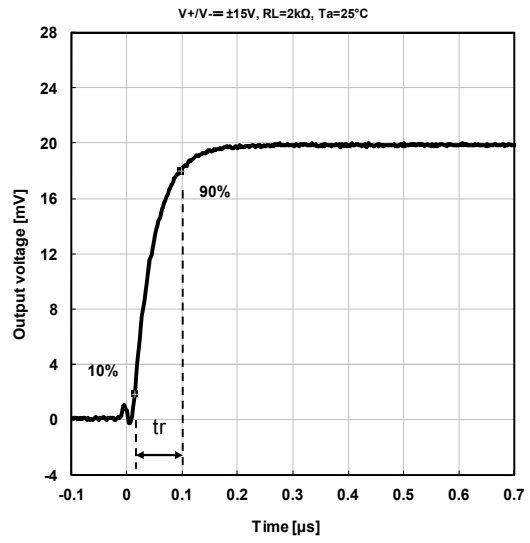

Total harmonic distortion versus frequency

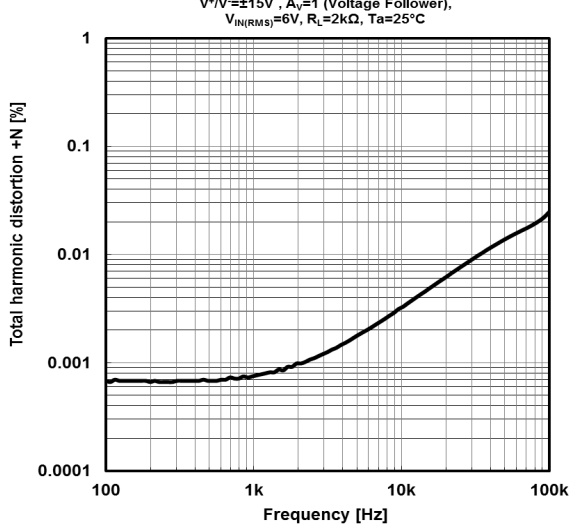

Equivalent input noise voltage versus frequency

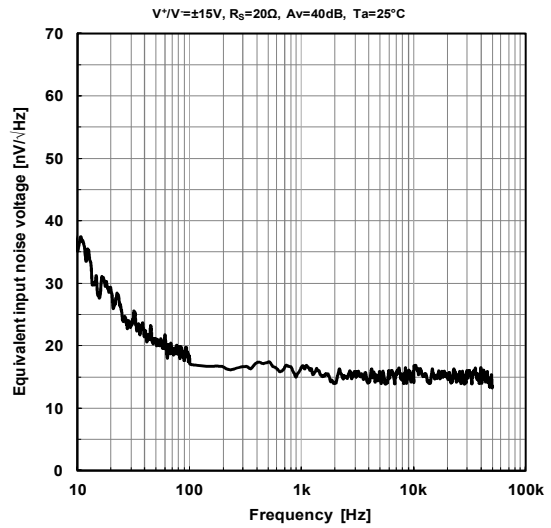

■ PACKAGE OUTLINE UNIT : mm

SOP8

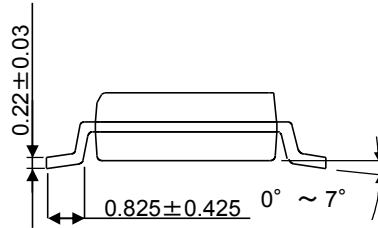
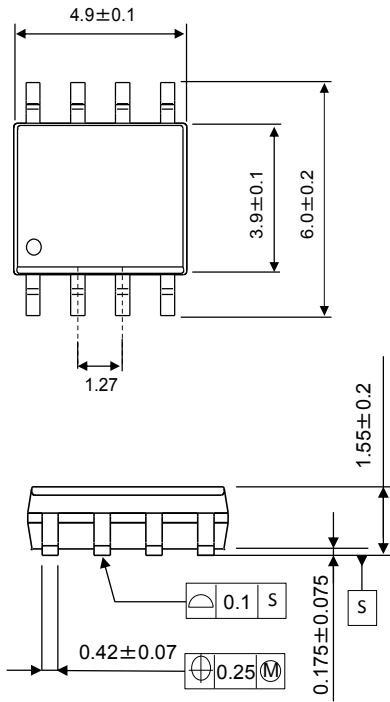

SOP14

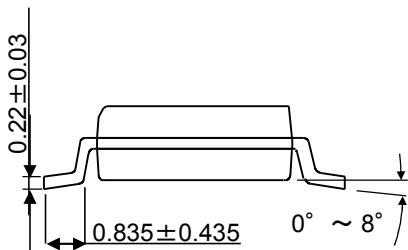
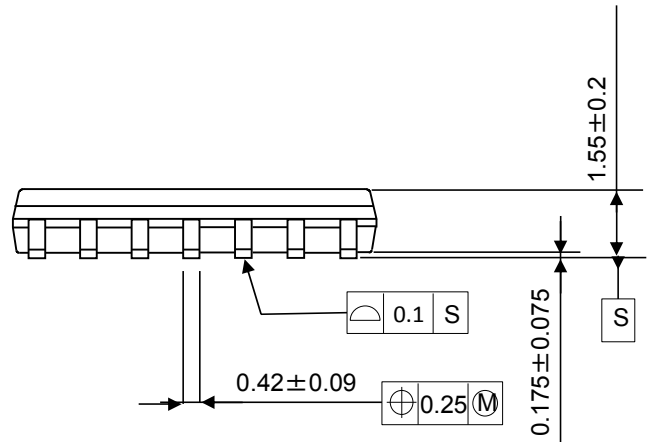
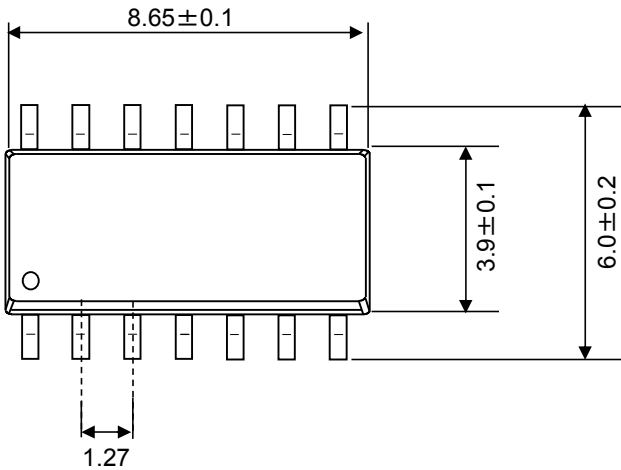

[CAUTION]  
 The specifications on this data book are only given for information, without any guarantee as regards either mistakes or omissions.  
 The application circuits in this data book are described only to show representative usages of the product and not intended for the guarantee or permission of any right including the industrial rights.



# Mouser Electronics

Authorized Distributor

Click to View Pricing, Inventory, Delivery & Lifecycle Information:

[NJR:](#)

[NJM084CG-TE2](#) [NJM082CAG-TE2](#) [NJM082CG-TE2](#) [NJM074CG-TE2](#) [NJM074CAG-TE2](#) [NJM072CG-TE2](#)  
[NJM084CAG-TE2](#) [NJM072CAG-TE2](#)



Компания «ЭлектроПласт» предлагает заключение долгосрочных отношений при поставках импортных электронных компонентов на взаимовыгодных условиях!

Наши преимущества:

- Оперативные поставки широкого спектра электронных компонентов отечественного и импортного производства напрямую от производителей и с крупнейших мировых складов;
- Поставка более 17-ти миллионов наименований электронных компонентов;
- Поставка сложных, дефицитных, либо снятых с производства позиций;
- Оперативные сроки поставки под заказ (от 5 рабочих дней);
- Экспресс доставка в любую точку России;
- Техническая поддержка проекта, помощь в подборе аналогов, поставка прототипов;
- Система менеджмента качества сертифицирована по Международному стандарту ISO 9001;
- Лицензия ФСБ на осуществление работ с использованием сведений, составляющих государственную тайну;
- Поставка специализированных компонентов (Xilinx, Altera, Analog Devices, Intersil, Interpoint, Microsemi, Aeroflex, Peregrine, Syfer, Eurofarad, Texas Instrument, Miteq, Cobham, E2V, MA-COM, Hittite, Mini-Circuits, General Dynamics и др.);

Помимо этого, одним из направлений компании «ЭлектроПласт» является направление «Источники питания». Мы предлагаем Вам помощь Конструкторского отдела:

- Подбор оптимального решения, техническое обоснование при выборе компонента;
- Подбор аналогов;
- Консультации по применению компонента;
- Поставка образцов и прототипов;
- Техническая поддержка проекта;
- Защита от снятия компонента с производства.



#### Как с нами связаться

**Телефон:** 8 (812) 309 58 32 (многоканальный)

**Факс:** 8 (812) 320-02-42

**Электронная почта:** [org@eplast1.ru](mailto:org@eplast1.ru)

**Адрес:** 198099, г. Санкт-Петербург, ул. Калинина, дом 2, корпус 4, литера А.