

1 dB LSB SILICON MMIC 4-BIT DIGITAL POSITIVE CONTROL ATTENUATOR, 0.1 - 8 GHz

Typical Applications

The HMC540SLP3E is ideal for both RF and IF applications:

- Cellular Infrastructure
- Wireless Infrastructure
- Microwave Radio & VSAT
- Test Equipment and Sensors

Functional Diagram

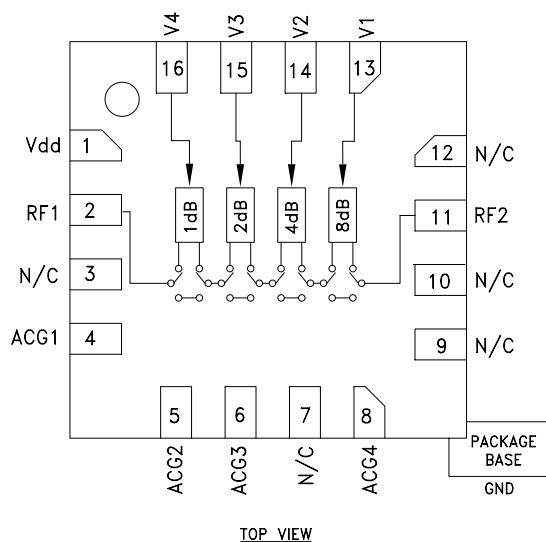

Features

- 1 dB LSB Steps to 15 dB
- ± 0.2 dB Typical Step Error
- Low Insertion Loss: ≤ 1 dB
- High IP3: +56 dBm
- Single Control Line Per Bit
- TTL/CMOS Compatible Control
- Single +3.3/+5V Supply
- 3x3 mm SMT Package
- ESD rating: Class 2 (2kV HBM)
- Drop-in Replacement for HMC540LP3E

General Description

The HMC540SLP3E is a broadband 4-bit Silicon IC digital attenuator in a low cost leadless surface mount package. This single positive control line per bit digital attenuator utilizes off chip AC ground capacitors for near DC operation, making it suitable for a wide variety of RF and IF applications. Covering 0.1 to 8 GHz, the insertion loss is less than 1 dB typical. The attenuator bit values are 1 (LSB), 2, 4 and 8 dB for a total attenuation of 15 dB. Attenuation accuracy is excellent at ± 0.2 dB typical step error. The attenuator also features a IIP3 of +56dBm. Four TTL/CMOS control inputs are used to select each attenuation state. It can operate with a single Vdd ranging from +3.3V to 5V.

Electrical Specifications,

$T_A = +25^\circ\text{C}$, With $V_{dd} = +5\text{V}$ & $V_{ctl} = 0/+5\text{V}$ (Unless Otherwise Noted)

Parameter	Frequency (GHz)	Min.	Typ.	Max.	Units
Insertion Loss	0.1 - 2.0 GHz		0.7	1.1	dB
	2.0 - 3.0 GHz		0.8	1.3	dB
	3.0 - 4.0 GHz		0.8	1.6	dB
	4.0 - 5.5 GHz		1.0	2.6	dB
	5.5 - 8.0 GHz		1.7	3.0	dB
Attenuation Range	0.1 - 8 GHz		15		dB
Return Loss (RF1 & RF2, All Atten. States)	0.1 - 3.5 GHz		22		dB
	3.5 - 5.5 GHz		17		dB
	5.5 - 8 GHz		12		dB
Attenuation Accuracy: (Referenced to Insertion Loss)	All States	0.1 - 1.0 GHz	± (0.2 + 2% of Atten. Setting) Max.		dB
		1.0 - 4.0 GHz	± (0.2 + 3% of Atten. Setting) Max.		dB
		4.0 - 5.0 GHz	± (0.3 + 5% of Atten. Setting) Max.		dB
		5.0 - 5.5 GHz	± (0.4 + 8% of Atten. Setting) Max.		dB
		5.5 GHz - 8 GHz	± (0.5 + 9% of Atten. Setting) Max.		dB

1 dB LSB SILICON MMIC 4-BIT DIGITAL POSITIVE CONTROL ATTENUATOR, 0.1 - 8 GHz

Parameter	Frequency (GHz)	Min.	Typ.	Max.	Units
Input Power for 0.1 dB Compression	0.1 - 8 GHz		31		dBm
Input Third Order Intercept Point (Two-Tone Input Power= 12 dBm Each Tone)	0.1 - 8 GHz	REF - 4 dB States 5 - 15 dB States	57 55		dBm
Switching Characteristics	DC - 8 GHz				
tRISE, tFALL (10/90% RF)			45		ns
tON, tOFF (50% CTL to 10/90% RF)			129		ns

Frequency Response Plots up to 6 GHz

Insertion Loss

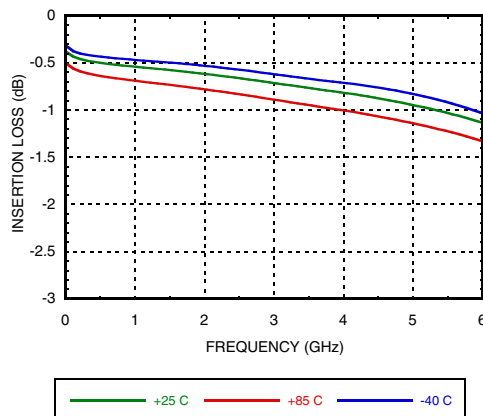

Return Loss RF1, RF2 (Only Major States are Shown)

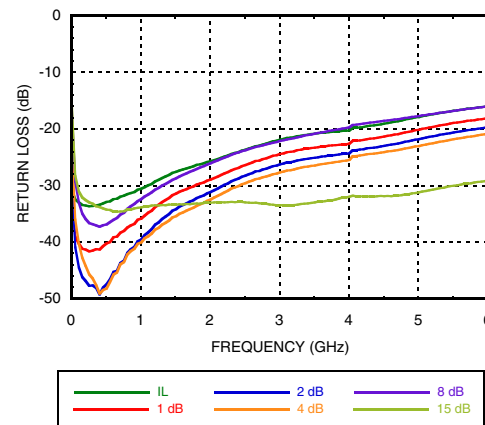

Normalized Attenuation (Only Major States are Shown)

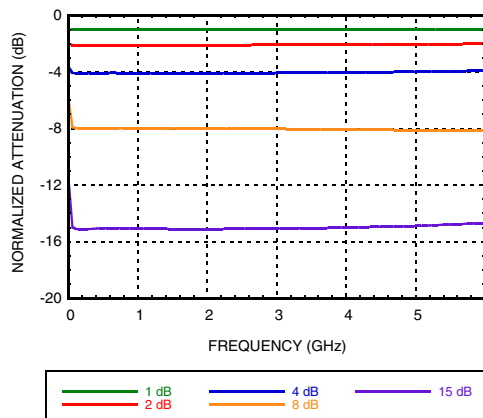

Bit Error vs. Attenuation State

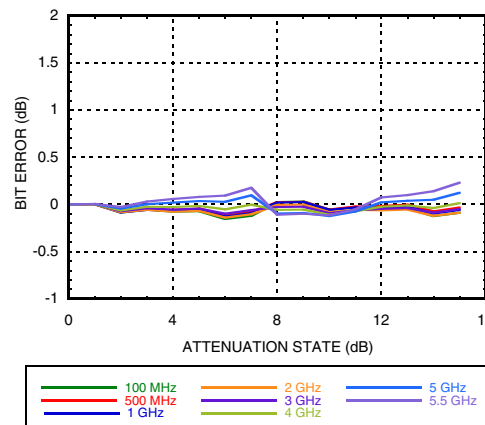

Information furnished by Analog Devices is believed to be accurate and reliable. However, no responsibility is assumed by Analog Devices for its use, nor for any infringements of patents or other rights of third parties that may result from its use. Specifications subject to change without notice. No license is granted by implication or otherwise under any patent or patent rights of Analog Devices. Trademarks and registered trademarks are the property of their respective owners.

For price, delivery, and to place orders: Analog Devices, Inc., One Technology Way, P.O. Box 9106, Norwood, MA 02062-9106
Phone: 781-329-4700 • Order online at www.analog.com
Application Support: Phone: 1-800-ANALOG-D

**1 dB LSB SILICON MMIC 4-BIT DIGITAL
POSITIVE CONTROL ATTENUATOR, 0.1 - 8 GHz**

Bit Error vs. Frequency

(Only Major States are Shown)



Relative Phase vs. Frequency

(Only Major States are Shown)

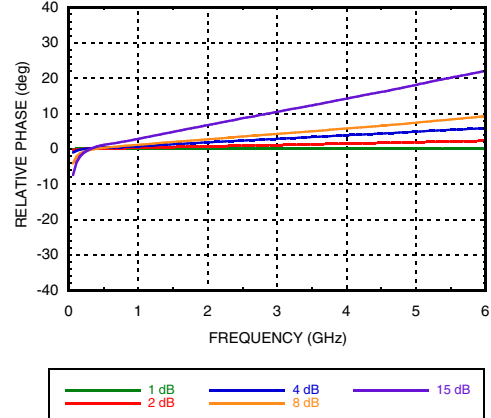

Step Error vs Frequency (Major States)

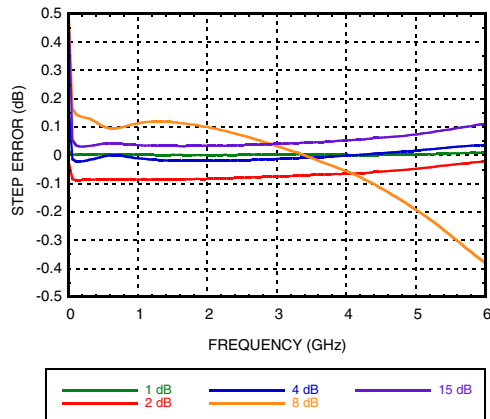

Information furnished by Analog Devices is believed to be accurate and reliable. However, no responsibility is assumed by Analog Devices for its use, nor for any infringements of patents or other rights of third parties that may result from its use. Specifications subject to change without notice. No license is granted by implication or otherwise under any patent or patent rights of Analog Devices. Trademarks and registered trademarks are the property of their respective owners.

For price, delivery, and to place orders: Analog Devices, Inc., One Technology Way, P.O. Box 9106, Norwood, MA 02062-9106 Phone: 781-329-4700 • Order online at www.analog.com Application Support: Phone: 1-800-ANALOG-D

**1 dB LSB SILICON MMIC 4-BIT DIGITAL
POSITIVE CONTROL ATTENUATOR, 0.1 - 8 GHz**

**Frequency Response Plots up to 10 GHz
Insertion Loss**

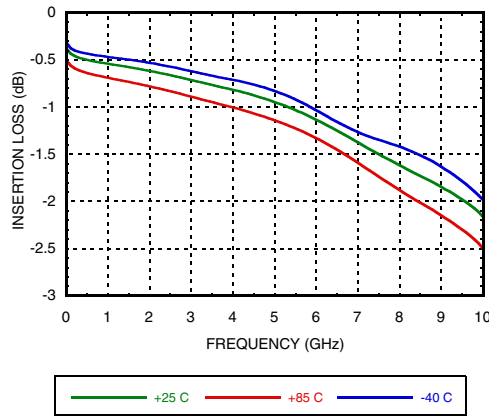

**Return Loss RF1, RF2
(Only Major States are Shown)**

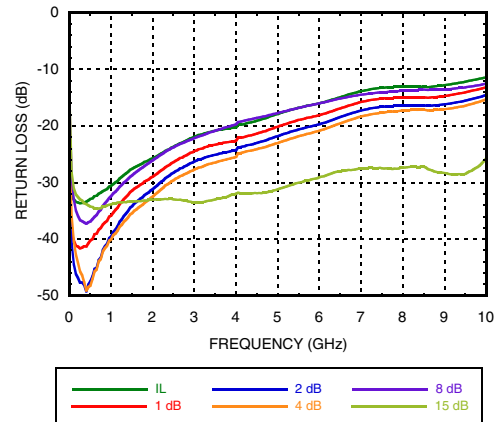

**Normalized Attenuation
(Only Major States are Shown)**

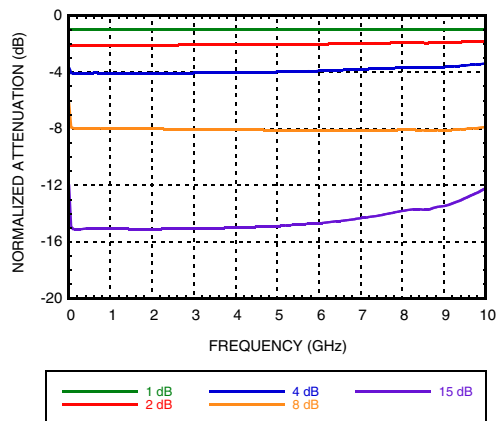

Bit Error vs. Attenuation State

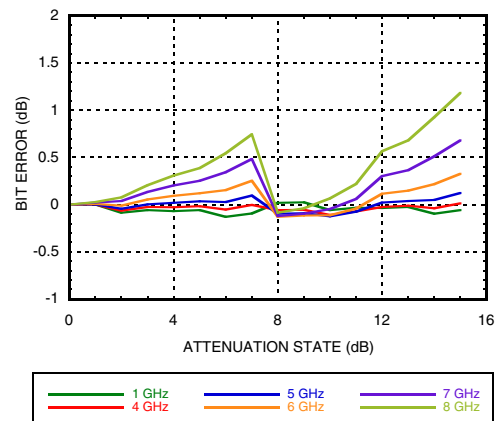

**Bit Error vs. Frequency
(Only Major States are Shown)**

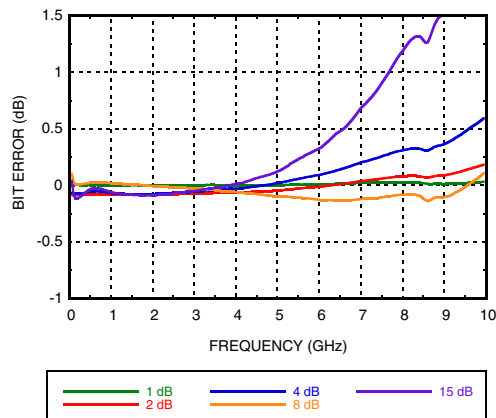

**Relative Phase vs. Frequency
(Only Major States are Shown)**

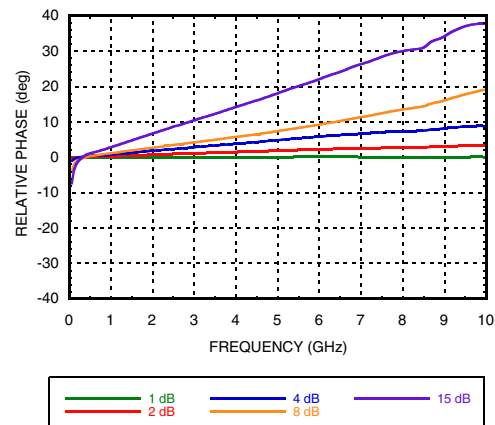

Information furnished by Analog Devices is believed to be accurate and reliable. However, no responsibility is assumed by Analog Devices for its use, nor for any infringements of patents or other rights of third parties that may result from its use. Specifications subject to change without notice. No license is granted by implication or otherwise under any patent or patent rights of Analog Devices. Trademarks and registered trademarks are the property of their respective owners.

For price, delivery, and to place orders: Analog Devices, Inc., One Technology Way, P.O. Box 9106, Norwood, MA 02062-9106 Phone: 781-329-4700 • Order online at www.analog.com Application Support: Phone: 1-800-ANALOG-D

**1 dB LSB SILICON MMIC 4-BIT DIGITAL
POSITIVE CONTROL ATTENUATOR, 0.1 - 8 GHz**

Step Error vs Frequency (Major States)

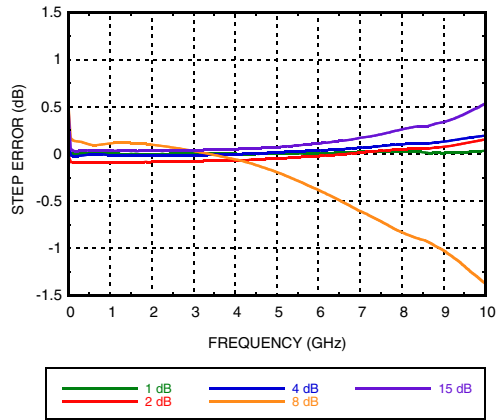

1 dB LSB SILICON MMIC 4-BIT DIGITAL POSITIVE CONTROL ATTENUATOR, 0.1 - 8 GHz

**Power Handling up to 8 GHz
Input Third Order Intercept Point over
Temp., 5V (100 MHz - 8 GHz)**



**Input Third Order Intercept Point over
Temp., 3.3V (100 MHz - 8 GHz)**

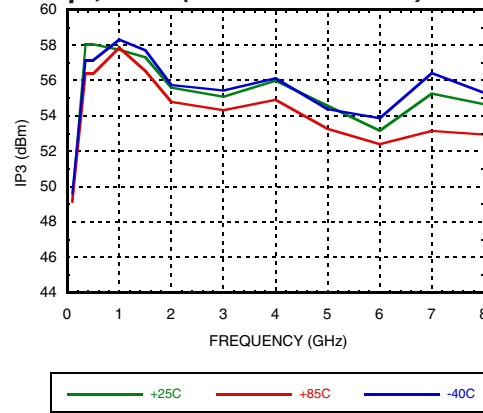

**0.1 and 1 dB Input Compression Point, 5V
(100 MHz - 8 GHz)**



**1 dB Input Compression Point, Over
Temp., 5V (100 MHz - 8 GHz)**

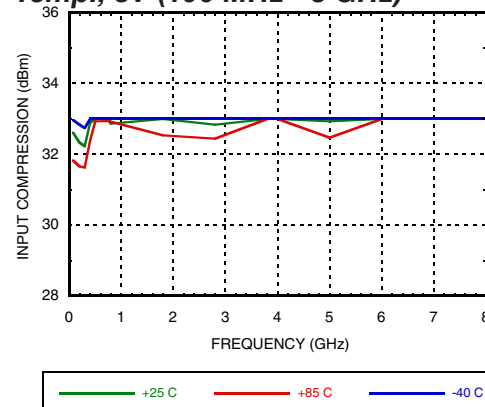

**0.1 and 1 dB Input Compression Point,
3.3V (100 MHz - 8 GHz)**



**1 dB Input Compression Point, Over
Temp., 3.3V (100 MHz - 8 GHz)**

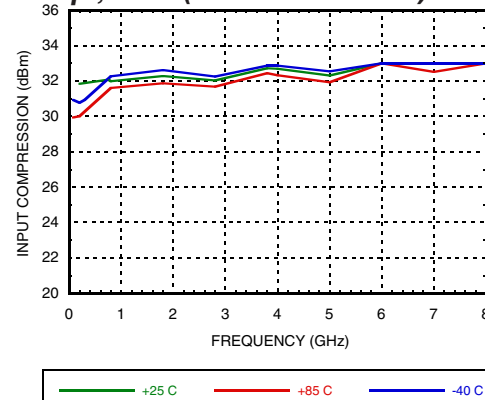

Information furnished by Analog Devices is believed to be accurate and reliable. However, no responsibility is assumed by Analog Devices for its use, nor for any infringements of patents or other rights of third parties that may result from its use. Specifications subject to change without notice. No license is granted by implication or otherwise under any patent or patent rights of Analog Devices. Trademarks and registered trademarks are the property of their respective owners.

For price, delivery, and to place orders: Analog Devices, Inc., One Technology Way, P.O. Box 9106, Norwood, MA 02062-9106 Phone: 781-329-4700 • Order online at www.analog.com Application Support: Phone: 1-800-ANALOG-D

1 dB LSB SILICON MMIC 4-BIT DIGITAL POSITIVE CONTROL ATTENUATOR, 0.1 - 8 GHz

Absolute Maximum Ratings

RF Input Power at 85 °C	+27 dBm
RF Input Power at 105 °C	+25 dBm
Bias Voltage (Vdd)	-0.3V to 5.4V
Control Voltage Range (V1 to V4)	-0.3V to Vdd +.5V
Channel Temperature	140 °C
Thermal Resistance (at maximum power dissipation)	110 °C/W
ESD Sensitivity (HBM)	Class 2
Storage Temperature	-65 to +150 °C

Recommended Operation Ratings

RF Input Power at 85 °C	+24 dBm
RF Input Power at 105 °C	+23 dBm
Bias Voltage (Vdd)	3V to 5.4V
Control Voltage Range (V1 to V4)	0 to Vdd
Operating Temperature	-40 to +105 °C



ELECTROSTATIC SENSITIVE DEVICE
OBSERVE HANDLING PRECAUTIONS

Bias Voltage & Current

Vdd (V)	Idd (Typ.) (mA)
+3.3	0.14
+5.0	0.17

Control Voltage

State	Vdd = +3.3V	Vdd = +5V
Low	0 to 0.5V @ < 1 uA	0 to +0.8V @ < 1 uA
High	2 to 3.3V @ 25 uA	2 to 5V @ 35 uA

Truth Table

Control Voltage Input				Attenuation State RF1 - RF2
V1 8 dB	V2 4 dB	V3 2 dB	V4 1 dB	
High	High	High	High	Reference I.L.
High	High	High	Low	1 dB
High	High	Low	High	2 dB
High	Low	High	High	4 dB
Low	High	High	High	8 dB
Low	Low	Low	Low	15 dB

Any combination of the above states will provide an attenuation approximately equal to the sum of the bits selected.

1 dB LSB SILICON MMIC 4-BIT DIGITAL POSITIVE CONTROL ATTENUATOR, 0.1 - 8 GHz

Outline Drawing

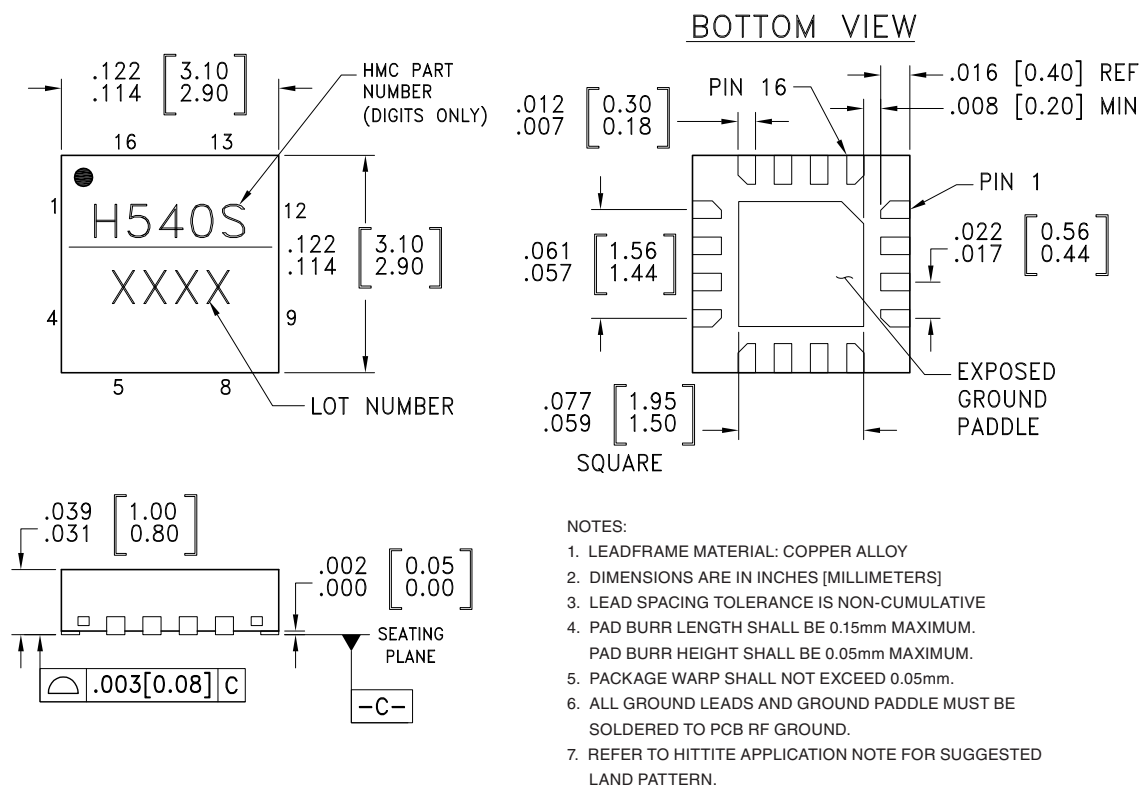

Package Information

Part Number	Package Body Material	Lead Finish	MSL Rating	Package Marking ^[3]
HMC540SLP3E	RoHS-compliant Low Stress Injection Molded Plastic	100% matte Sn	MSL3 ^[2]	H540S XXXX

[1] Max peak reflow temperature of 235 °C

[2] Max peak reflow temperature of 260 °C

[3] 4-Digit lot number XXXX

1 dB LSB SILICON MMIC 4-BIT DIGITAL POSITIVE CONTROL ATTENUATOR, 0.1 - 8 GHz

Pin Descriptions

Pin Number	Function	Description	Interface Schematic
1	Vdd	Supply Voltage.	
2, 11	RF1, RF2	This pin is DC coupled and matched to 50 Ohm. Blocking capacitors are required. Select value based on lowest frequency of operation.	
3, 7, 9, 10, 12	N/C	These pins should be connected to PCB RF ground to maximize performance.	
4 - 6, 8	ACG1 - ACG4	External capacitor to ground is required. Select value for lowest frequency of operation. Place capacitor as close to pins as possible.	
13 - 16	V1 - V4	See truth table and control voltage table.	
	GND	Package bottom has an exposed metal paddle that must be connected to RF/DC Ground.	

Application Circuit

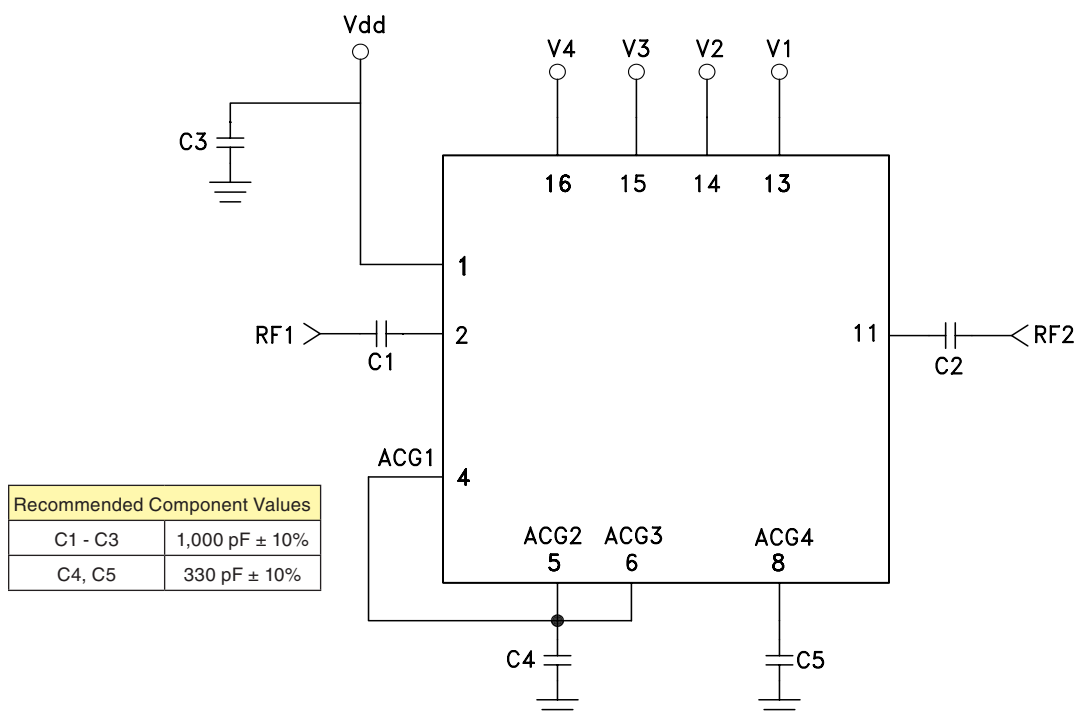

1 dB LSB SILICON MMIC 4-BIT DIGITAL POSITIVE CONTROL ATTENUATOR, 0.1 - 8 GHz

Evaluation PCB

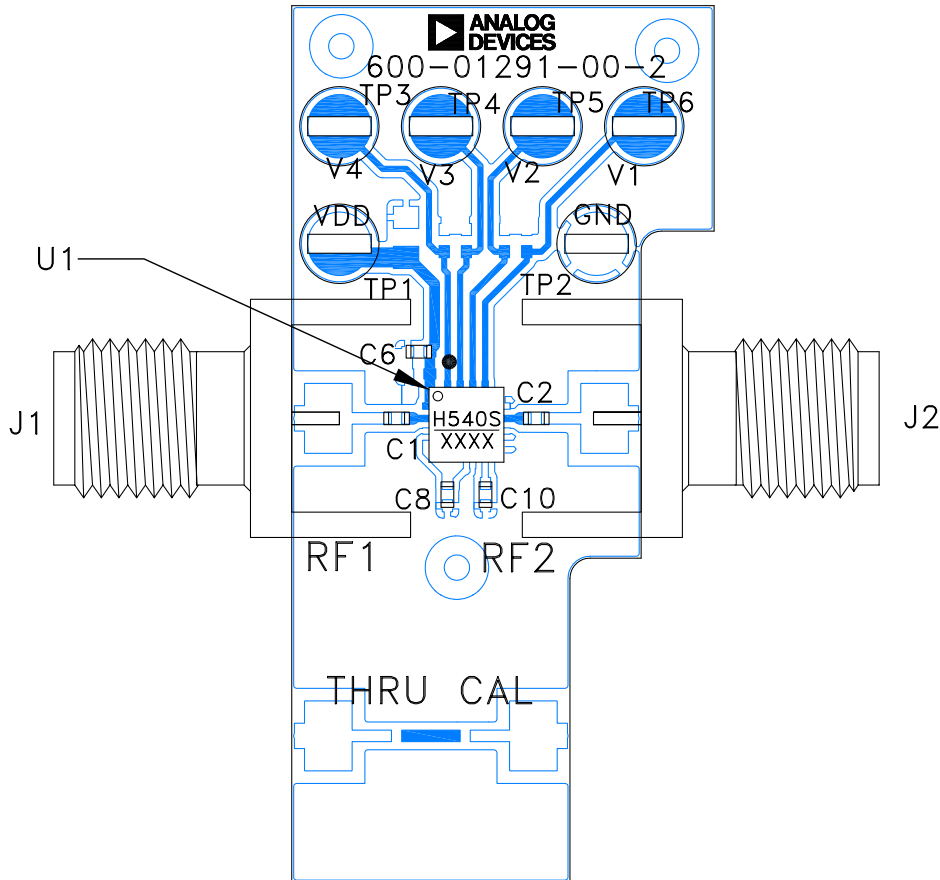

List of Materials for Evaluation PCB EV1HMC540SLP3^[1]

Item	Description
J1, J2	PCB Mount SMA Connector
TP1 - TP6	Thru Hole Mount Test Point
C1, C2, C6	1000 pF Capacitor, 0402 Pkg.
C8, C10	330 pF Capacitor, 0402 Pkg.
U1	HMC540SLP3E Digital Attenuator
PCB [2]	600-01291-00 Evaluation PCB

[1] Reference this number when ordering complete evaluation PCB

[2] Circuit Board Material: Rogers 4350

The circuit board used in the application should use RF circuit design techniques. Signal lines should have 50 Ohm impedance while the package ground leads and exposed paddle should be connected directly to the ground plane similar to that shown. A sufficient number of via holes should be used to connect the top and bottom ground planes. The evaluation circuit board shown is available from Analog Devices upon request.



Компания «ЭлектроПласт» предлагает заключение долгосрочных отношений при поставках импортных электронных компонентов на взаимовыгодных условиях!

Наши преимущества:

- Оперативные поставки широкого спектра электронных компонентов отечественного и импортного производства напрямую от производителей и с крупнейших мировых складов;
- Поставка более 17-ти миллионов наименований электронных компонентов;
- Поставка сложных, дефицитных, либо снятых с производства позиций;
- Оперативные сроки поставки под заказ (от 5 рабочих дней);
- Экспресс доставка в любую точку России;
- Техническая поддержка проекта, помощь в подборе аналогов, поставка прототипов;
- Система менеджмента качества сертифицирована по Международному стандарту ISO 9001;
- Лицензия ФСБ на осуществление работ с использованием сведений, составляющих государственную тайну;
- Поставка специализированных компонентов (Xilinx, Altera, Analog Devices, Intersil, Interpoint, Microsemi, Aeroflex, Peregrine, Syfer, Eurofarad, Texas Instrument, Miteq, Cobham, E2V, MA-COM, Hittite, Mini-Circuits, General Dynamics и др.);

Помимо этого, одним из направлений компании «ЭлектроПласт» является направление «Источники питания». Мы предлагаем Вам помощь Конструкторского отдела:

- Подбор оптимального решения, техническое обоснование при выборе компонента;
- Подбор аналогов;
- Консультации по применению компонента;
- Поставка образцов и прототипов;
- Техническая поддержка проекта;
- Защита от снятия компонента с производства.



Как с нами связаться

Телефон: 8 (812) 309 58 32 (многоканальный)

Факс: 8 (812) 320-02-42

Электронная почта: org@eplast1.ru

Адрес: 198099, г. Санкт-Петербург, ул. Калинина, дом 2, корпус 4, литера А.