

Micro D Series Filtered Connectors

For designs that require even smaller connector packages, Spectrum has designed a line of filtered Micro D-Subminiature connectors. This line of connectors offers a range of reliable filtering options, including capacitive and ESD versions, and several sizes and termination options. Spectrum has a Micro D-sub connector to satisfy your smallest space constraints.

Features

- Light weight
- Compact size
- Environmentally sealed contact area when mated
- Corrosion resistant
- Durable (500 cycles min.)
- Superior electrical performance
- RoHS compliant



Mechanical Specifications

| | |
|-----------------------------------|---|
| <i>Shell</i> | Aluminum, electroless nickel plated 500 μ in (12.7 μ m) minimum |
| <i>Insulator</i> | High temperature plastic, flammability UL94V-0 |
| <i>Contacts</i> | Copper alloy, gold plated 50 μ in (1.27 μ m) minimum |
| <i>Potting</i> | Flammability UL94V-0 |
| <i>Interfacial Seal</i> | Silicon |

Electrical Specifications

| | |
|--|-------------------|
| <i>Operating Voltage</i> | 100 VDC |
| <i>Dielectric Withstanding Voltage</i> | 300 VDC |
| <i>Current Rating</i> | 3 Amps |
| <i>Insulation Resistance</i> | 5G ohms @ 100 VDC |

Ordering Information

Example: **56-F011-110-JP**

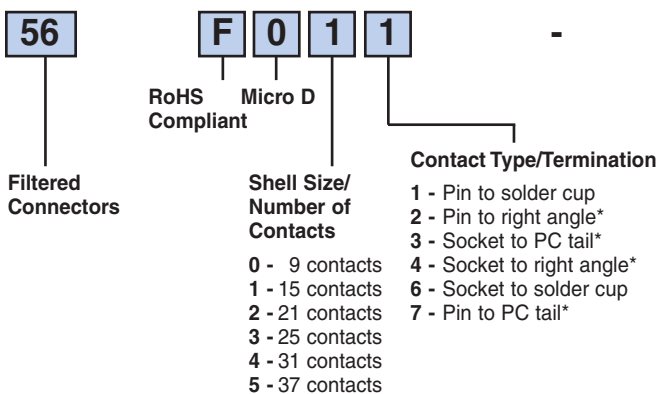

This part number represents a micro D-sub connector with a shell size of 15 and a pin to solder cup configuration. All lines are filtered with same capacitance value, which is 100 pF COB. The connector includes an optional #2-56 jack post.

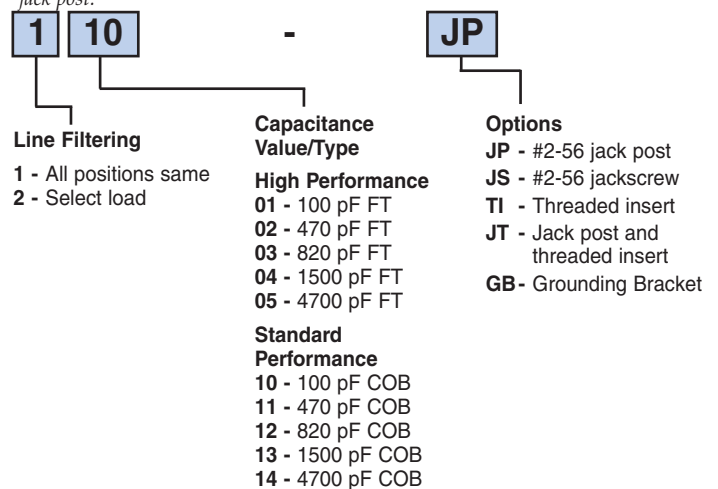

* Right angle and PC tail length is 0.109. Other lengths available, consult factory.

All capacitance values $\pm 20\%$ @ 25°C

Micro D Series Filtered Connectors

High Performance

| Filter Designation | Type | Capacitance | | Dielectric Withstanding Voltage | Working Voltage DC -55°C to +125°C | Minimum Insertion Loss - Decibels (dB) 50 ohm system per MIL-STD-220 (no load) | | | | | | | |
|--------------------|------|-------------|-----------|---------------------------------|------------------------------------|--|--------|--------|--------|---------|---------|---------|-------|
| | | Value | Tolerance | | | 5 MHz | 10 MHz | 20 MHz | 50 MHz | 100 MHz | 200 MHz | 500 MHz | 1 GHz |
| 01 | FT | 100 pF | ±20% | 300V | 100V | — | — | — | — | 1 | 6 | 14 | 20 |
| 02 | FT | 470 pF | ±20% | 300V | 100V | — | — | 2 | 8 | 14 | 20 | 28 | 34 |
| 03 | FT | 820 pF | ±20% | 300V | 100V | — | 2 | 6 | 13 | 19 | 25 | 33 | 39 |
| 04 | FT | 1500 pF | ±20% | 300V | 100V | — | 5 | 10 | 18 | 24 | 30 | 38 | 44 |
| 05 | FT | 4700 pF | ±20% | 300V | 100V | 8 | 14 | 20 | 28 | 34 | 40 | 48 | 54 |

Standard Performance

| Filter Designation | Type | Capacitance | | Dielectric Withstanding Voltage | Working Voltage DC -55°C to +125°C | Minimum Insertion Loss - Decibels (dB) 50 ohm system per MIL-STD-220 (no load) | | | | | | | |
|--------------------|------|-------------|-----------|---------------------------------|------------------------------------|--|--------|--------|--------|---------|---------|---------|-------|
| | | Value | Tolerance | | | 5 MHz | 10 MHz | 20 MHz | 50 MHz | 100 MHz | 200 MHz | 500 MHz | 1 GHz |
| 10 | COB | 100 pF | ±20% | 300V | 100V | — | — | — | — | 1 | 6 | 14 | 20 |
| 11 | COB | 470 pF | ±20% | 300V | 100V | — | — | 2 | 8 | 14 | 20 | 28 | 32 |
| 12 | COB | 820 pF | ±20% | 300V | 100V | — | 2 | 6 | 13 | 19 | 25 | 32 | 32 |
| 13 | COB | 1500 pF | ±20% | 300V | 100V | — | 5 | 10 | 18 | 24 | 30 | 32 | 32 |
| 14 | COB | 4700 pF | ±20% | 300V | 100V | 8 | 14 | 20 | 28 | 32 | 32 | 32 | 32 |

Right Angle PCB

Receptacle

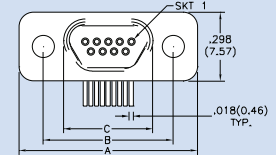
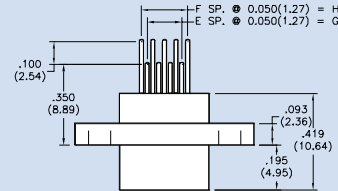
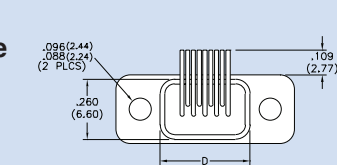

Plug

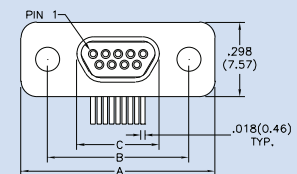
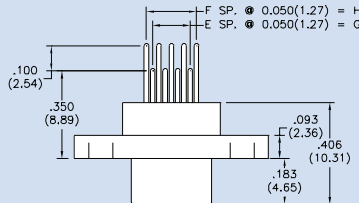
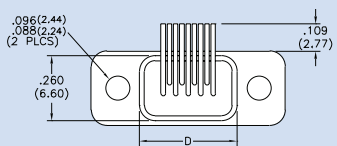

| Size | A | B | C (RCPT) | C (Plug) | D | E | F | G | H |
|------|---------------|---------------|---------------|---------------|---------------|----|----|--------------|--------------|
| 9 | .775 (19.69) | .565 (14.35) | .388 (9.86) | .330 (8.38) | .390 (9.91) | 4 | 5 | .200 (5.08) | .250 (6.35) |
| 15 | .925 (23.50) | .715 (18.16) | .538 (13.67) | .480 (12.19) | .540 (13.72) | 7 | 8 | .350 (8.89) | .400 (10.16) |
| 21 | 1.075 (27.31) | .865 (21.97) | .688 (17.48) | .630 (16.00) | .690 (17.53) | 10 | 11 | .500 (12.70) | .550 (13.97) |
| 25 | 1.175 (29.85) | .965 (24.51) | .788 (20.02) | .730 (18.54) | .790 (20.07) | 12 | 13 | .600 (15.24) | .650 (16.51) |
| 31 | 1.325 (33.66) | 1.115 (28.32) | .938 (23.83) | .880 (22.35) | .940 (23.88) | 15 | 16 | .750 (19.05) | .800 (20.32) |
| 37 | 1.475 (37.47) | 1.265 (32.13) | 1.088 (27.64) | 1.030 (26.16) | 1.090 (27.69) | 18 | 19 | .900 (22.86) | .950 (24.13) |

Dimensions in inches (mm)

Micro D Series Filtered Connectors

| Size | A | B | C (RCPT) | C (Plug) | D |
|------|------------------|------------------|------------------|------------------|------------------|
| 9 | .775 (19.69) | .565 (14.35) | .388 (9.86) | .330 (8.38) | .390 (9.91) |
| 15 | .925 (23.50) | .715 (18.16) | .538 (13.67) | .480 (12.19) | .540 (13.72) |
| 21 | 1.075 (27.31) | .865 (21.97) | .688 (17.48) | .630 (16.00) | .690 (17.53) |
| 25 | 1.175 (29.85) | .965 (24.51) | .788 (20.02) | .730 (18.54) | .790 (20.07) |
| 31 | 1.325 (33.66) | 1.115 (28.32) | .938 (23.83) | .880 (22.35) | .940 (23.88) |
| 37 | 1.475 (37.47) | 1.265 (32.13) | 1.088 (27.64) | 1.030 (26.16) | 1.090 (27.69) |

Dimensions in inches (mm)

Vertical PCB

Receptacle

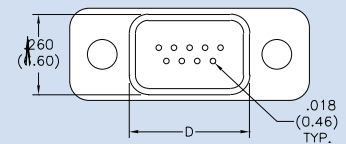
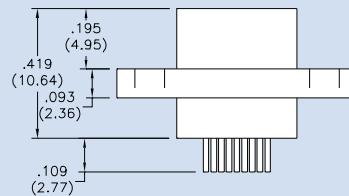
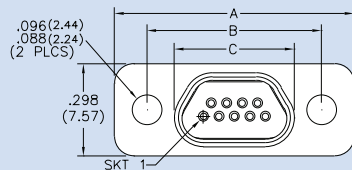

Plug

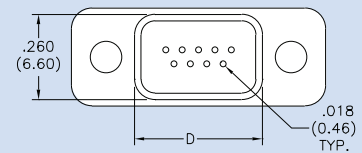
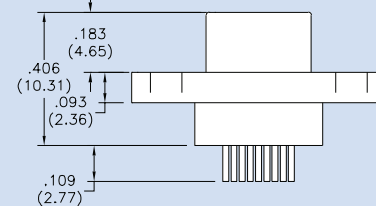
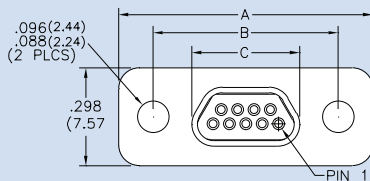

Solder Cup

Receptacle

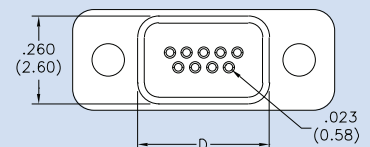
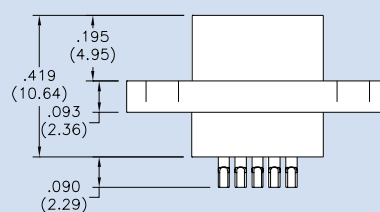
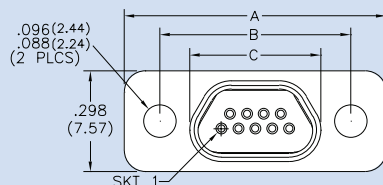

Plug

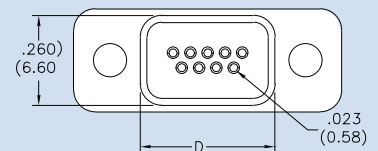
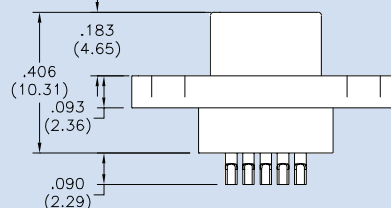
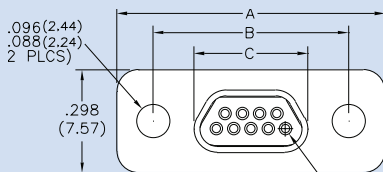

Micro D Series Filtered Connectors Options

JP - #2-56 Jack Post M83513/05-07

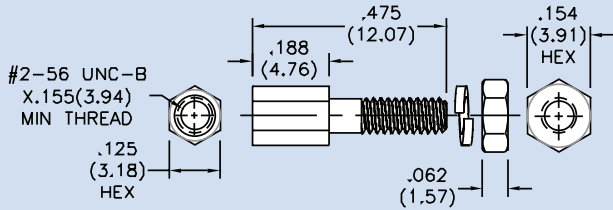

JS - #2-56 Jack Screw M83513/05-05

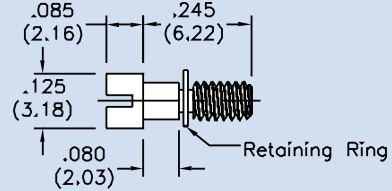

TI - Threaded Insert Receptacle

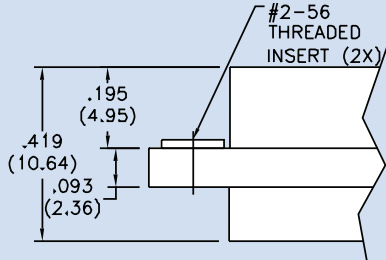

TI - Threaded Insert Plug

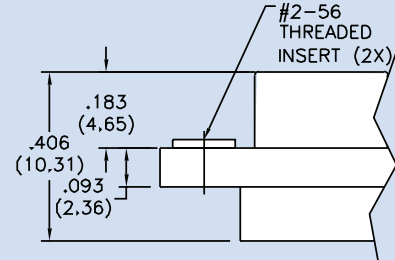

GB - Ground Bracket Receptacle

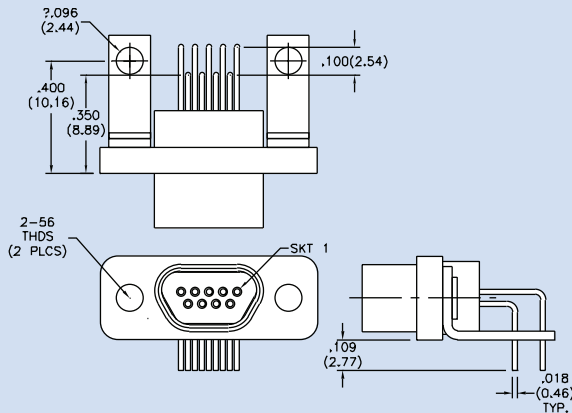

GB - Ground Bracket Plug

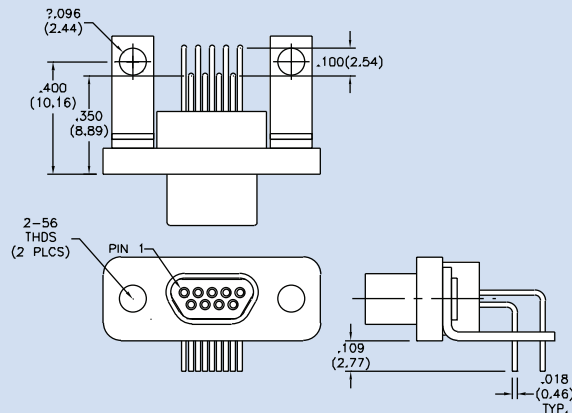

Micro D Series Filtered Connectors Board and Panel Cutouts

Vertical PCB Layouts

Pin Connector Shown

9 Contacts

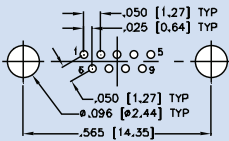

15 Contacts

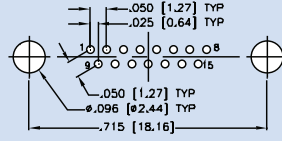

21 Contacts

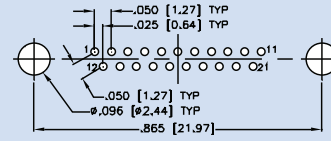

25 Contacts

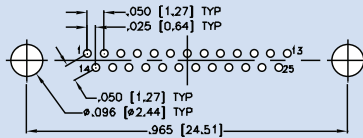

31 Contacts

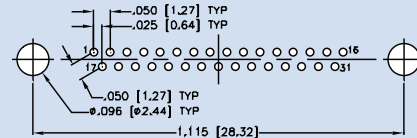

37 Contacts

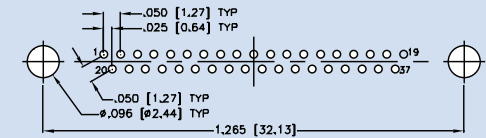

Right Angle PCB Layouts

Pin Connector Shown

9 Contacts

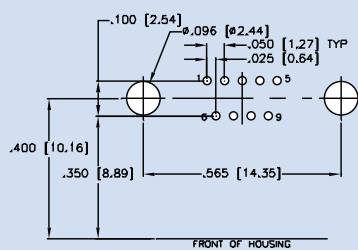

15 Contacts

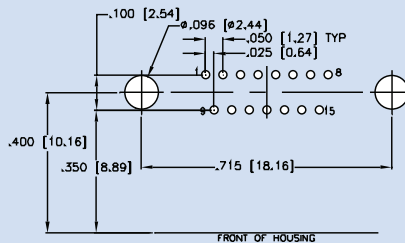

21 Contacts

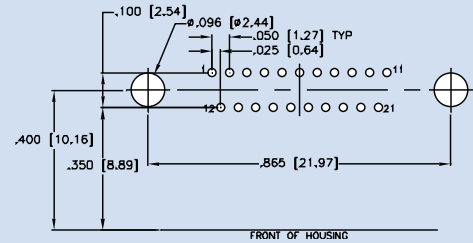

25 Contacts

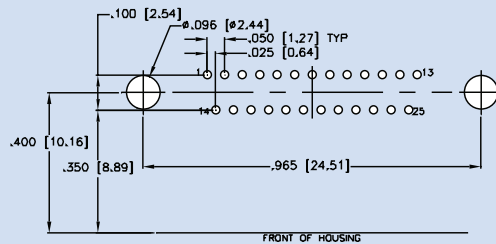

31 Contacts

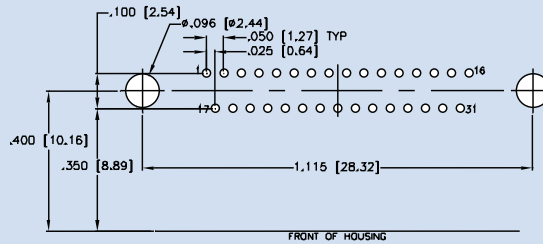

37 Contacts

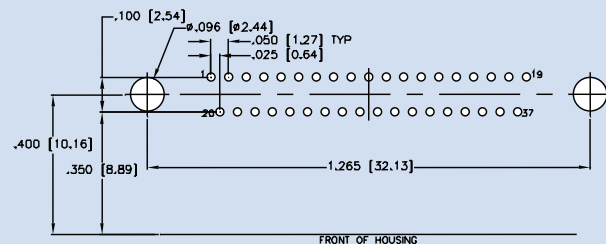

Notes: PC Tail Diameter 0.018 ±0.002 (0.46 ±0.05) Contact numbers shown are pin connector.
Reverse for socket. Patterns shown are for connector mounting side of PC board.



Компания «ЭлектроПласт» предлагает заключение долгосрочных отношений при поставках импортных электронных компонентов на взаимовыгодных условиях!

Наши преимущества:

- Оперативные поставки широкого спектра электронных компонентов отечественного и импортного производства напрямую от производителей и с крупнейших мировых складов;
- Поставка более 17-ти миллионов наименований электронных компонентов;
- Поставка сложных, дефицитных, либо снятых с производства позиций;
- Оперативные сроки поставки под заказ (от 5 рабочих дней);
- Экспресс доставка в любую точку России;
- Техническая поддержка проекта, помощь в подборе аналогов, поставка прототипов;
- Система менеджмента качества сертифицирована по Международному стандарту ISO 9001;
- Лицензия ФСБ на осуществление работ с использованием сведений, составляющих государственную тайну;
- Поставка специализированных компонентов (Xilinx, Altera, Analog Devices, Intersil, Interpoint, Microsemi, Aeroflex, Peregrine, Syfer, Eurofarad, Texas Instrument, Miteq, Cobham, E2V, MA-COM, Hittite, Mini-Circuits, General Dynamics и др.);

Помимо этого, одним из направлений компании «ЭлектроПласт» является направление «Источники питания». Мы предлагаем Вам помощь Конструкторского отдела:

- Подбор оптимального решения, техническое обоснование при выборе компонента;
- Подбор аналогов;
- Консультации по применению компонента;
- Поставка образцов и прототипов;
- Техническая поддержка проекта;
- Защита от снятия компонента с производства.



Как с нами связаться

Телефон: 8 (812) 309 58 32 (многоканальный)

Факс: 8 (812) 320-02-42

Электронная почта: org@eplast1.ru

Адрес: 198099, г. Санкт-Петербург, ул. Калинина, дом 2, корпус 4, литера А.