

PDC Dual Band MIXER GaAs MMIC

■GENERAL DESCRIPTION

The NJG1560PB1 is a mixer GaAs MMIC includes local amplifier targeted to dual band (800MHz, 1.5GHz) application. The band switching between 800MHz and 1500MHz is made by 1bit control signal by using inverter circuit included in this IC.

The ultra small and thin FFP12-B1 is applied.

■PACKAGE OUTLINE

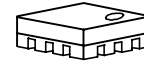

NJG1560PB1

■FEATURES

- | | | |
|-----------------------------|---|--|
| ●Low voltage operation | +2.8V typ. | |
| ●Low current consumption | 5.9mA typ. | |
| ●Low Inverter current | 100uA typ. | |
| ●High conversion gain | 11dB typ. | @V _{CTL} =0V, f _{RF1} =820MHz |
| | 11dB typ. | @V _{CTL} =2.4V, f _{RF2} =1489MHz |
| ●High input IP3 | +3dBm typ. | @V _{CTL} =0V, f _{RF1} =820MHz |
| | +3dBm typ. | @V _{CTL} =2.4V, f _{RF2} =1489MHz |
| ●Low noise figure | 5.5dB typ. | @V _{CTL} =0V, f _{RF1} =820MHz |
| | 5.0dB typ. | @V _{CTL} =2.4V, f _{RF2} =1489MHz |
| ●Ultra small & thin package | FFP12-B1 (Package size: 2.0mmx2.0mmx0.85mm) | |

■PIN CONFIGURATION

(Top View)

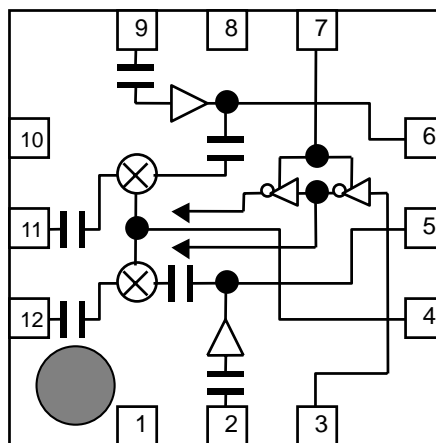

Pin Connection

1. GND
2. LOIN1 (800MHz)
3. VCTL
4. IFOUT
5. VLO1 (800MHz)
6. VLO2 (1.5GHz)
7. VINV
8. GND
9. LOIN2 (1.5GHz)
10. GND
11. RFIN2 (1.5GHz)
12. RFIN1 (800MHz)

Note: The specifications and description listed in this catalog are subject to change without prior notice.

NJG1560PB1

■ABSOLUTE MAXIMUM RATINGS

($T_a=25^{\circ}\text{C}$, $Z_s=Z_l=50\Omega$)

PARAMETERS	SYMBOL	CONDITIONS	RATINGS	UNITS
Operating voltage	V_{DD}	IFOUT, VLO 1, VLO2, VINV ports	5.0	V
Control voltage	V_{CTL}	VCTL port	V_{INV}	V
Input power	P_{in}	RFIN1, RFIN2, LOIN1, LOIN2 ports	+10	dBm
Power dissipation	P_D		300	mW
Operating temperature	T_{opr}		-40~+85	$^{\circ}\text{C}$
Storage temperature	T_{stg}		-55~+125	$^{\circ}\text{C}$

■ELECTRICAL CHARACTERISTICS 1 (DC)

GENERAL CONDITIONS: $T_a=25^{\circ}\text{C}$, $V_{MIX}=V_{LO1}=V_{LO2}=V_{INV}=2.8\text{V}$

PARAMETERS	SYMBOL	CONDITIONS	MIN	TYP	MAX	UNITS
Mixer supply voltage	V_{MIX}	IFOUT port	2.5	2.8	4.5	V
Local Amplifier supply voltage 1	V_{LO1}	VLO1 ports	2.5	2.8	4.5	V
Local Amplifier supply voltage 2	V_{LO2}	VLO2 ports	2.5	2.8	4.5	V
Inverter supply voltage	V_{INV}	VINV port	2.5	2.8	4.5	V
Mixer current	I_{MIX}	IFOUT port, $P_{RF}=P_{LO}=\text{OFF}$, $V_{CTL}=0\text{V}$ or 2.4V	-	4.9	6.1	mA
Local Amplifier current1	I_{LO1}	VLO1 port, $P_{RF}=P_{LO}=\text{OFF}$, $V_{CTL}=0\text{V}$	-	1.0	1.2	mA
Local Amplifier current2	I_{LO2}	VLO2port, $P_{RF}=P_{LO}=\text{OFF}$, $V_{CTL}=2.4\text{V}$	-	1.0	1.2	mA
Inverter current	I_{INV}	VINV port	-	100	150	μA
Control voltage (LOW)	$V_{CTL(L)}$	VCTL port	0	0	0.8	V
Control voltage (HIGH)	$V_{CTL(H)}$	VCTL port	2.0	2.4	V_{INV}	V
Control current	I_{CTL}	VCTL port, $V_{CTL}=2.4\text{V}$	-	20	40	μA

■ ELECTRICAL CHARACTERISTICS 2 (800MHz RF)

GENERAL CONDITIONS: $T_a=+25^{\circ}\text{C}$, $V_{\text{MIX}}=V_{\text{LO1}}=V_{\text{INV}}=2.8\text{V}$, $V_{\text{CTL}}=0\text{V}$, $f_{\text{RF1}}=820\text{MHz}$,
 $P_{\text{RF1}}=-30\text{dBm}$, $f_{\text{LO1}}=689.95\text{MHz}$, $P_{\text{LO1}}=-15\text{dBm}$,
 $f_{\text{IF}}=130.05\text{MHz}$, $Z_s=Z_l=50\Omega$, with application circuit

PARAMETERS	SYMBOL	CONDITIONS	MIN	TYP	MAX	UNITS
Operating frequency	freq	RFIN1 port	810	820	885	MHz
Conversion gain	Gc		10.0	11.0	12.0	dB
Noise figure	NF	SSB NF	-	5.5	6.5	dB
Input 3rd order intercept point	IIP3	2 tone offset frequency=100kHz	0	+3.0	-	dBm
Pout at 1dB gain compression point	$P_{-1\text{dB(IN)}}$		-11.0	-9.0	-	dBm
RF IN1 port VSWR	VSWR_{RF}		-	1.5	2.0	
LOCAL IN1 port VSWR	VSWR_{LO}		-	1.5	2.0	
IF OUT port VSWR	VSWR_{IF}		-	1.5	2.0	

■ ELECTRICAL CHARACTERISTICS 3 (1.5GHz RF)

GENERAL CONDITIONS: $T_a=+25^{\circ}\text{C}$, $V_{\text{MIX}}=V_{\text{LO2}}=V_{\text{INV}}=2.8\text{V}$, $V_{\text{CTL}}=2.4\text{V}$, $f_{\text{RF2}}=1489\text{MHz}$,
 $P_{\text{RF2}}=-30\text{dBm}$, $f_{\text{LO2}}=1358.95\text{MHz}$, $P_{\text{LO2}}=-15\text{dBm}$,
 $f_{\text{IF}}=130.05\text{MHz}$, $Z_s=Z_l=50\Omega$, with application circuit

PARAMETERS	SYMBOL	CONDITIONS	MIN	TYP	MAX	UNITS
Operating frequency	freq	RFIN2 port	1477	1489	1501	MHz
Conversion gain	Gc		10.0	11.0	12.0	dB
Noise figure	NF	SSB NF	-	5.0	6.0	dB
Input 3rd order intercept point	IIP3	2 tone offset frequency=100kHz	0	+3.0	-	dBm
Pout at 1dB gain compression point	$P_{-1\text{dB(IN)}}$		-11.0	-9.0	-	dBm
RF IN2 port VSWR	VSWR_{RF}		-	1.5	2.0	
LOCAL IN2 port VSWR	VSWR_{LO}		-	1.5	2.0	
IF OUT port VSWR	VSWR_{IF}			1.5	2.0	

NJG1560PB1

■TERMINAL INFORMATION

Pin	Symbol	Description
1	GND	Ground terminal(0V).
2	LOIN1	Local power input terminal of 800MHz band local amplifier. External matching circuit is required.
3	VCTL	Control voltage input terminal. This terminal is set to 800MHz band or 1.5GHz band to select.
4	IFOUT	IF signal output terminal for mixer external matching circuit is required. Please connect mixer power supply through choke inductor (L7) as shown in test circuit.
5	VLO1	800MHz band local amplifier supply terminal. Please place L6 close to this terminal as shown in test circuit.
6	VLO2	1.5GHz band local amplifier supply terminal. Please place L5 close to this terminal as shown in test circuit.
7	VINV	Power supply terminal of the inverter circuit.
8	GND	Ground terminal(0V).
9	LOIN2	Local power input terminal of 1.5GHz local amplifier. External matching circuit is required.
10	GND	Ground terminal(0V).
11	RFIN2	RF input terminal of 1.5GHz band mixer. External matching circuit is required.
12	RFIN1	RF input terminal of 800MHz band mixer. External matching circuit is required.

NOTE:

- 1) Ground terminal (1, 8, 10pin) should be connected to ground plane by multiple via holes for good grounding.

TYPICAL CHARACTERISTICS (800MHz Band)

Gc , NF vs. RF Frequency

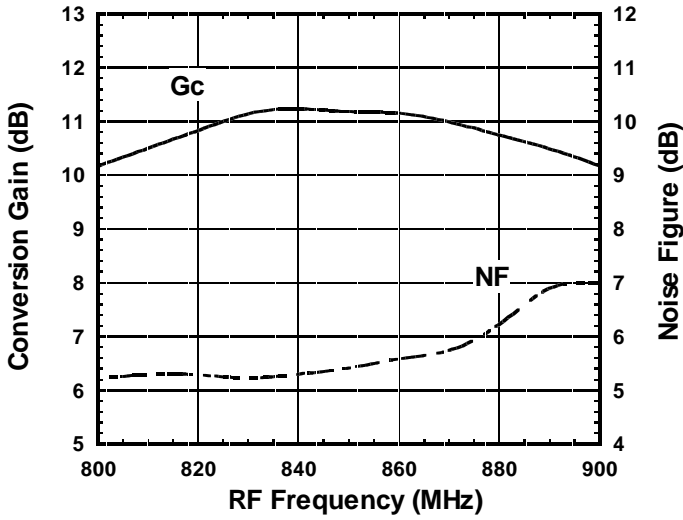

Condition
 $f_{IF}=130.05\text{MHz}$
 $f_{RF}=800\sim 900\text{MHz}$, $P_{RF}=-30\text{dBm}$
 $f_{LO}=669.95\sim 769.95\text{MHz}$, $P_{LO}=-15\text{dBm}$
 $V_{MIX}=V_{LO}=V_{INV}=2.8\text{V}$
 $V_{CTL}=0\text{V}$

Gc, NF vs. LO Power

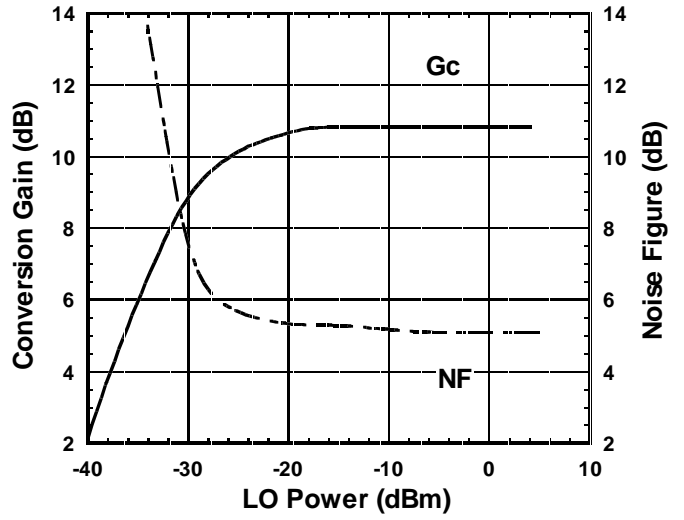

Condition
 $f_{IF}=130.05\text{MHz}$
 $f_{RF}=820\text{MHz}$, $P_{RF}=-30\text{dBm}$
 $f_{LO}=689.95\text{MHz}$
 $V_{MIX}=V_{LO}=V_{INV}=2.8\text{V}$
 $V_{CTL}=0\text{V}$

OIP3 , IIP3 vs. RF Frequency

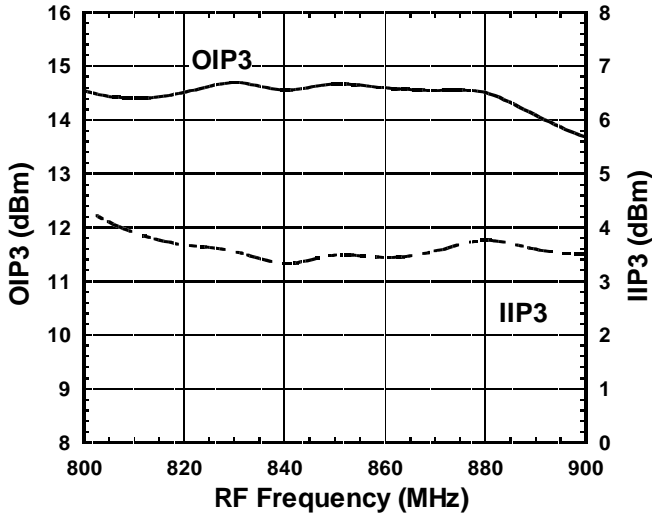

Condition
 $f_{IF}=130.05\text{MHz}$
 $f_{RF1}=800\sim 900\text{MHz}$
 $f_{RF2}=f_{RF1}+100\text{kHz}$, $P_{RF}=-30\text{dBm}$
 $f_{LO}=669.95\sim 769.95\text{MHz}$, $P_{LO}=-15\text{dBm}$
 $V_{MIX}=V_{LO}=V_{INV}=2.8\text{V}$
 $V_{CTL}=0\text{V}$

OIP3, IIP3 vs. LO Power

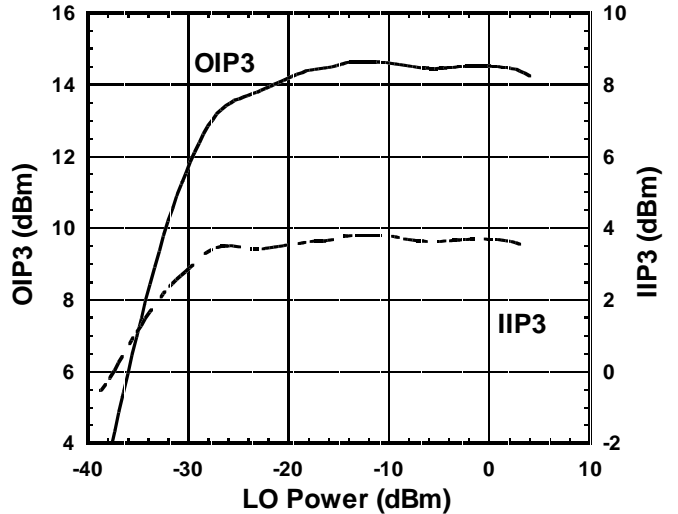

Condition
 $f_{IF}=130.05\text{MHz}$
 $f_{RF}=820.0+820.1\text{MHz}$,
 $P_{RF}=-30\text{dBm}$
 $f_{LO}=689.95\text{MHz}$
 $V_{MIX}=V_{LO}=V_{INV}=2.8\text{V}$
 $V_{CTL}=0\text{V}$

NJG1560PB1

TYPICAL CHARACTERISTICS (800MHz Band)

IF Output Power vs. RF Power

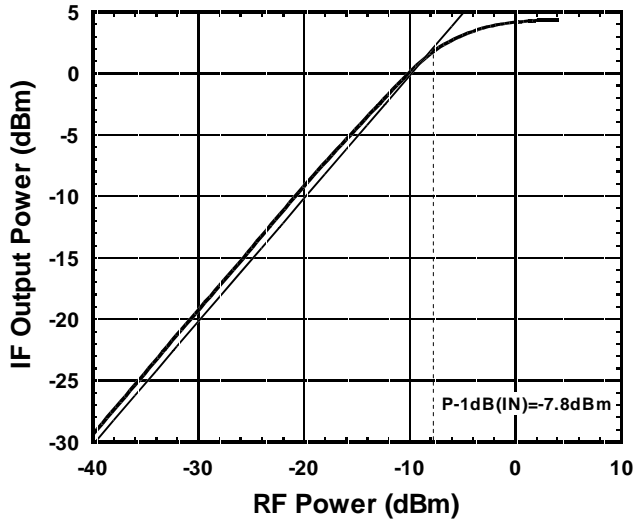

Condition
 $f_{IF}=130.05\text{MHz}$
 $f_{RF}=820\text{MHz}$
 $f_{LO}=689.95\text{MHz}$, $P_{LO}=-15\text{dBm}$
 $V_{MIX}=V_{LO}=V_{INV}=2.8\text{V}$
 $V_{CTL}=0\text{V}$

IF, IM3 vs. RF Power

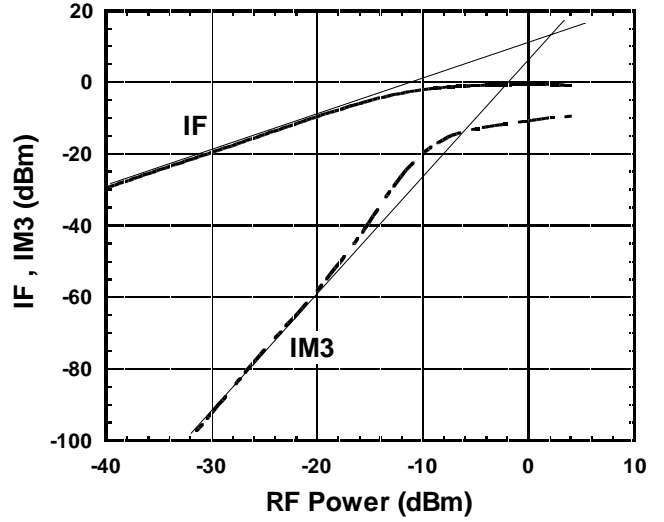

Condition
 $f_{IF}=130.05\text{MHz}$
 $f_{RF}=820.0+820.1\text{MHz}$
 $f_{LO}=689.95\text{MHz}$, $P_{LO}=-15\text{dBm}$
 $V_{MIX}=V_{LO}=V_{INV}=2.8\text{V}$
 $V_{CTL}=0\text{V}$

LOCAL Leak Level vs. LO Frequency

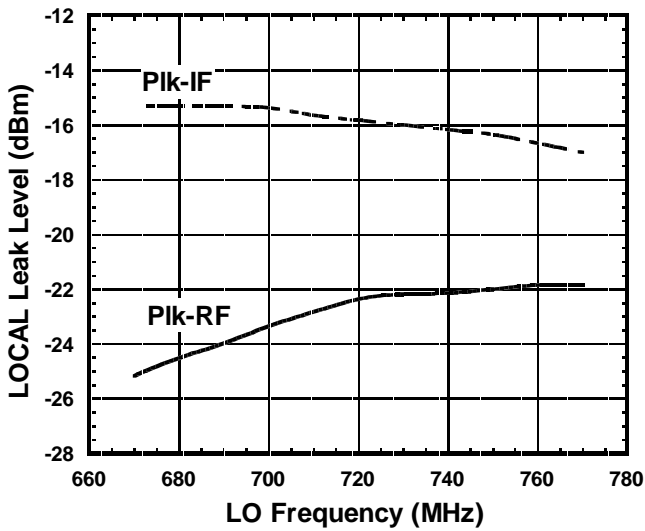

■ TYPICAL CHARACTERISTICS (800MHz Band)

Gc, NF vs. Ambient Temperature

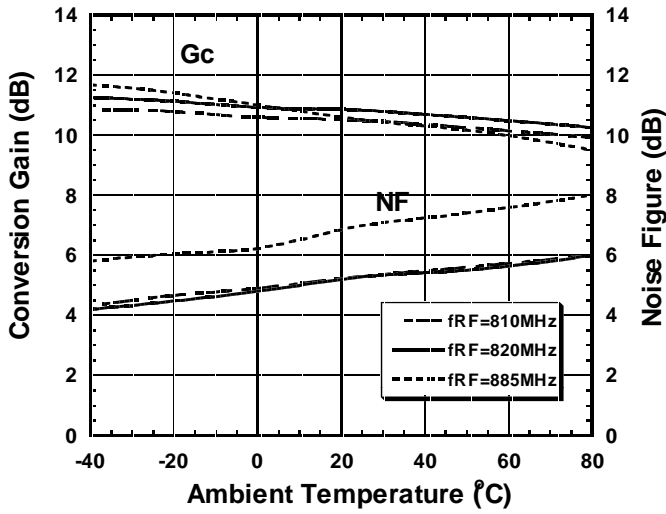

Condition

$f_{IF}=130.05\text{MHz}$
 $f_{RF}=810\sim 885\text{MHz}$, $P_{RF}=-30\text{dBm}$
 $f_{LO}=679.95\sim 754.95\text{MHz}$, $P_{LO}=-15\text{dBm}$
 $V_{MIX}=V_{LO}=V_{INV}=2.8\text{V}$
 $V_{CTL}=0\text{V}$

OIP3, IIP3 vs. Ambient Temperature

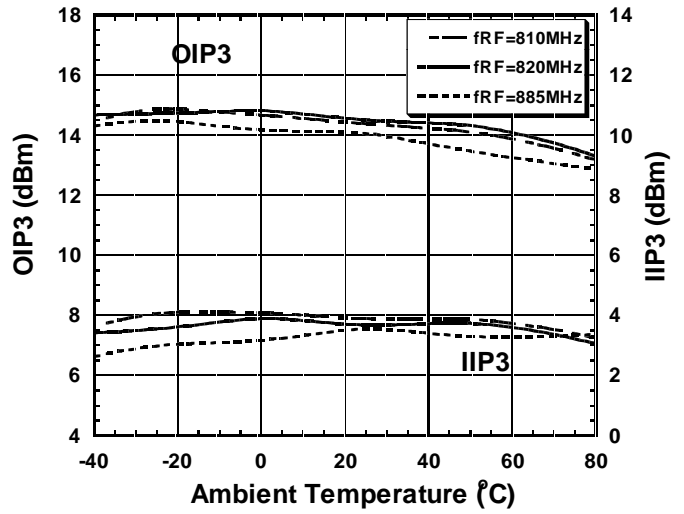

Condition

$f_{IF}=130.05\text{MHz}$
 $f_{RF1}=810\sim 885\text{MHz}$,
 $f_{RF2}=f_{RF1}+100\text{kHz}$, $P_{RF}=-30\text{dBm}$
 $f_{LO}=679.95\sim 754.95\text{MHz}$, $P_{LO}=-15\text{dBm}$
 $V_{MIX}=V_{LO}=V_{INV}=2.8\text{V}$
 $V_{CTL}=0\text{V}$

P-1dB(IN) vs. Ambient Temperature

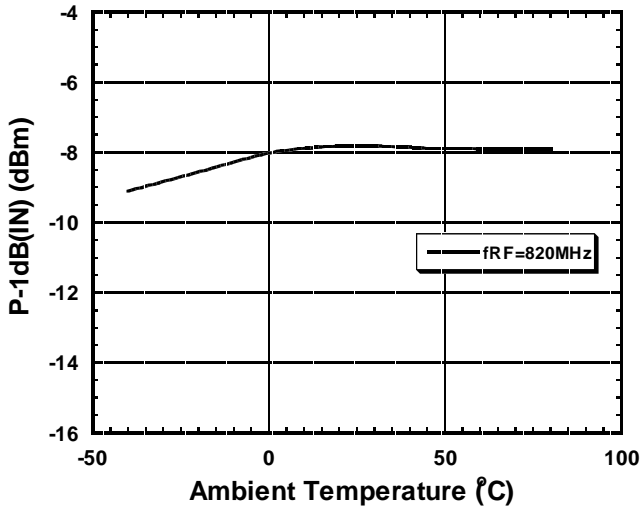

Condition

$f_{IF}=130.05\text{MHz}$
 $f_{RF}=820\text{MHz}$
 $f_{LO}=689.95\text{MHz}$, $P_{LO}=-15\text{dBm}$
 $V_{MIX}=V_{LO}=V_{INV}=2.8\text{V}$
 $V_{CTL}=0\text{V}$

NJG1560PB1

TYPICAL CHARACTERISTICS (800MHz Band)

Conversion Gain vs. Frequency

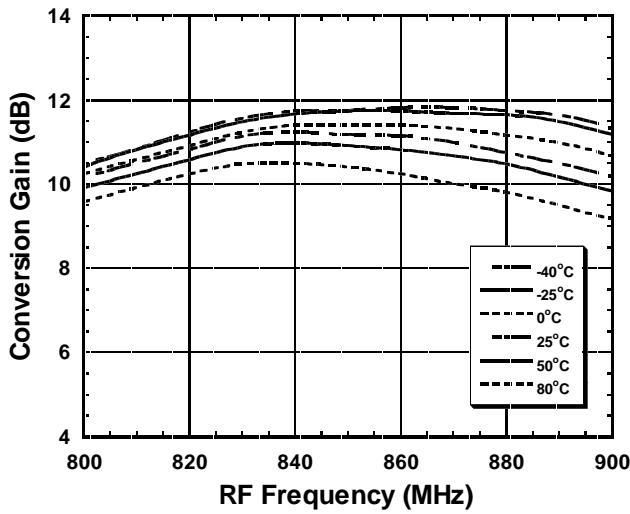

Condition
 $f_{IF}=130.05\text{MHz}$
 $f_{RF}=800\sim 900\text{MHz}$, $P_{RF}=-30\text{dBm}$
 $f_{LO}=669.95\sim 769.95\text{MHz}$, $P_{LO}=-15\text{dBm}$
 $V_{MIX}=V_{LO}=V_{INV}=2.8\text{V}$
 $V_{CTL}=0\text{V}$

Noise Figure vs. Frequency

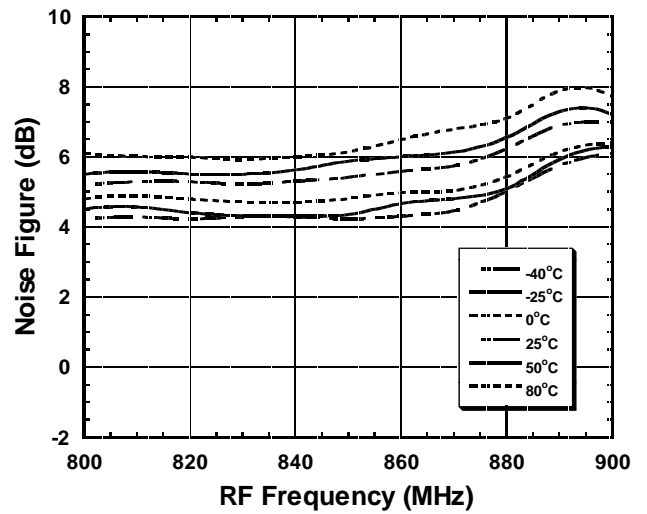

Condition
 $f_{IF}=130.05\text{MHz}$
 $f_{RF}=800\sim 900\text{MHz}$
 $f_{LO}=669.95\sim 769.95\text{MHz}$, $P_{LO}=-15\text{dBm}$
 $V_{MIX}=V_{LO}=V_{INV}=2.8\text{V}$
 $V_{CTL}=0\text{V}$

OIP3 vs. Frequency

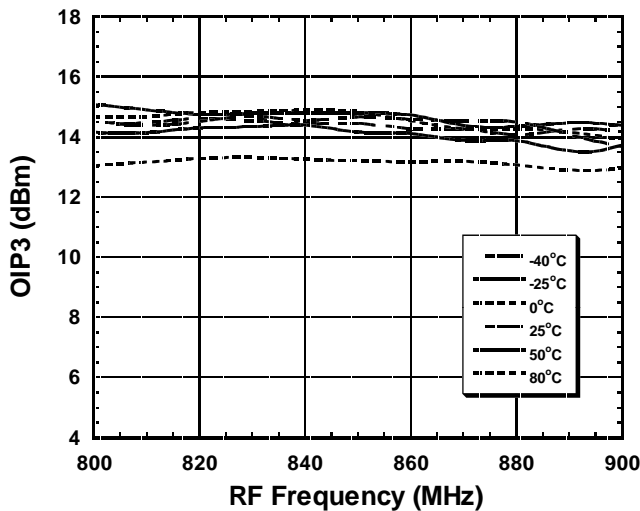

Condition
 $f_{IF}=130.05\text{MHz}$
 $f_{RF1}=800\sim 900\text{MHz}$
 $f_{RF2}=f_{RF1}+100\text{kHz}$, $P_{RF}=-30\text{dBm}$
 $f_{LO}=669.95\sim 769.95\text{MHz}$, $P_{LO}=-15\text{dBm}$
 $V_{MIX}=V_{LO}=V_{INV}=2.8\text{V}$
 $V_{CTL}=0\text{V}$

IIP3 vs. Frequency

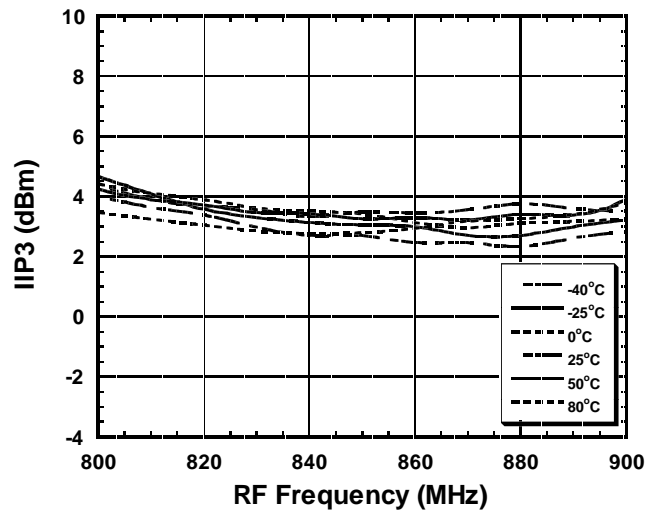

Condition
 $f_{IF}=130.05\text{MHz}$
 $f_{RF1}=800\sim 900\text{MHz}$
 $f_{RF2}=f_{RF1}+100\text{kHz}$, $P_{RF}=-30\text{dBm}$
 $f_{LO}=669.95\sim 769.95\text{MHz}$, $P_{LO}=-15\text{dBm}$
 $V_{MIX}=V_{LO}=V_{INV}=2.8\text{V}$
 $V_{CTL}=0\text{V}$

TYPICAL CHARACTERISTICS (800MHz Band)

Conversion Gain vs. LO Power

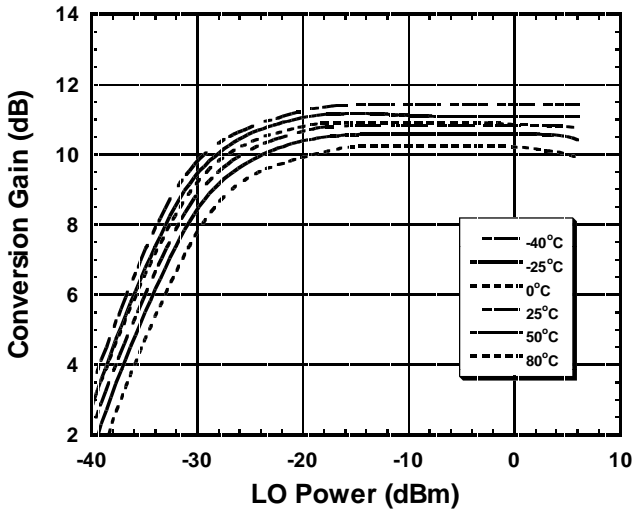

Condition
 $f_{IF}=130.05\text{MHz}$
 $f_{RF}=820\text{MHz}$, $P_{RF}=-30\text{dBm}$
 $f_{LO}=689.95\text{MHz}$
 $V_{MIX}=V_{LO}=V_{INV}=2.8\text{V}$
 $V_{CTL}=0\text{V}$

Noise Figure vs. LO Power

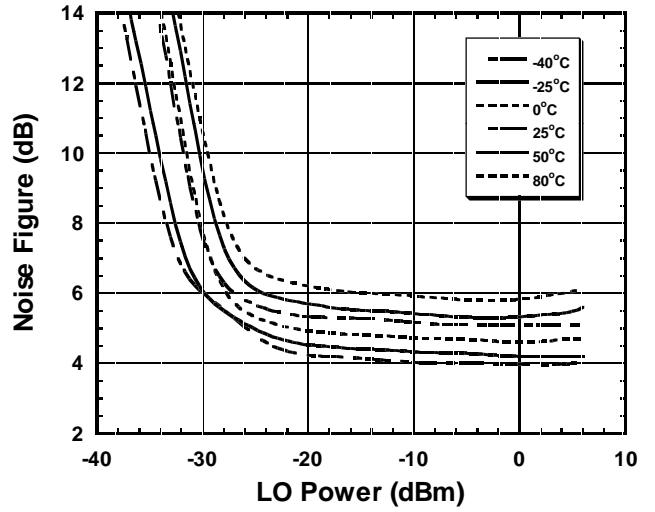

Condition
 $f_{IF}=130.05\text{MHz}$
 $f_{RF}=820\text{MHz}$
 $f_{LO}=689.95\text{MHz}$
 $V_{MIX}=V_{LO}=V_{INV}=2.8\text{V}$
 $V_{CTL}=0\text{V}$

OIP3 vs. LO Power

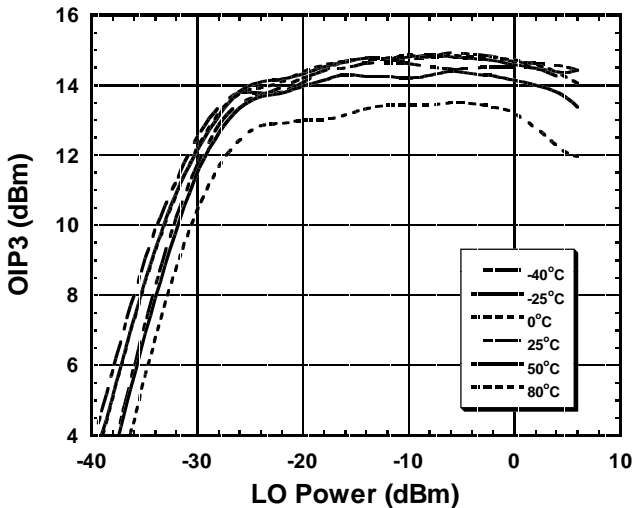

Condition
 $f_{IF}=130.05\text{MHz}$
 $f_{RF}=820.0+820.1\text{MHz}$,
 $P_{RF}=-30\text{dBm}$
 $f_{LO}=689.95\text{MHz}$
 $V_{MIX}=V_{LO}=V_{INV}=2.8\text{V}$
 $V_{CTL}=0\text{V}$

IIP3 vs. LO Power

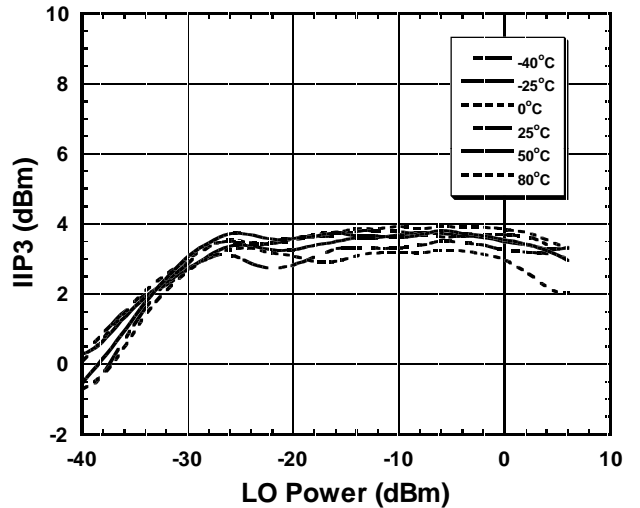

Condition
 $f_{IF}=130.05\text{MHz}$
 $f_{RF}=820.0+820.1\text{MHz}$,
 $P_{RF}=-30\text{dBm}$
 $f_{LO}=689.95\text{MHz}$
 $V_{MIX}=V_{LO}=V_{INV}=2.8\text{V}$
 $V_{CTL}=0\text{V}$

NJG1560PB1

TYPICAL CHARACTERISTICS (800MHz Band)

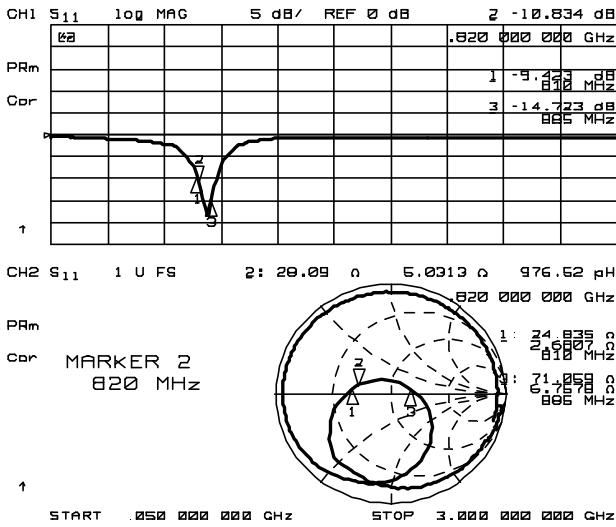

RF IN1 Port Impedance
 (LOCAL IN1 Port, IF OUT Port: 50Ω term.)

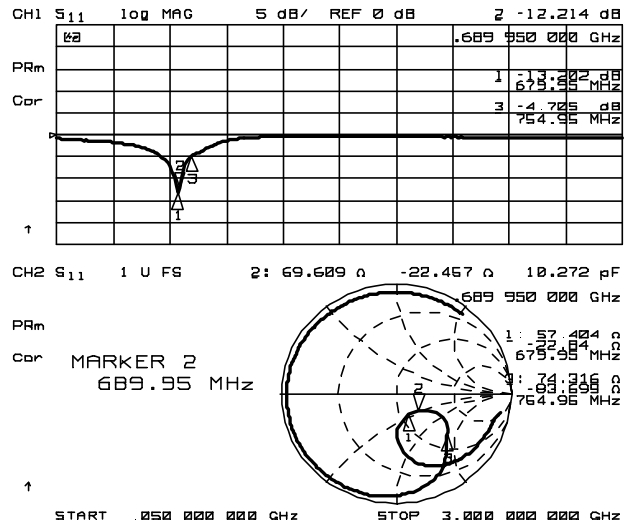

LOCAL IN1 Port Impedance
 (RF IN1 Port, IF OUT Port: 50Ω term.)

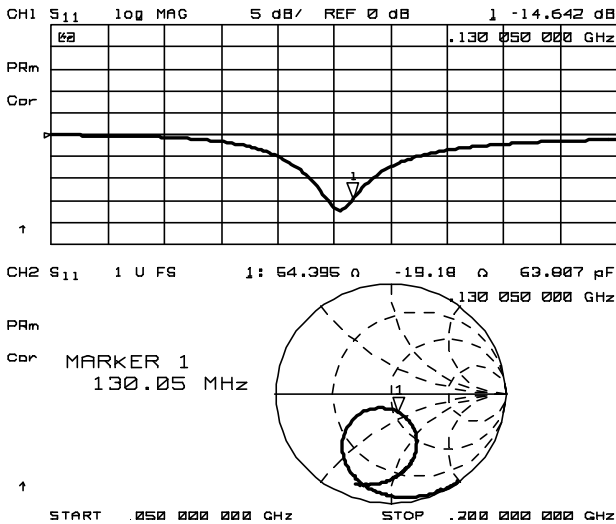

IF OUT Port Impedance
 (RF IN1 Port, LOCAL IN1 Port: 50Ω term.)

■ TYPICAL CHARACTERISTICS (1.5GHz Band)

Gc , NF vs. RF Frequency

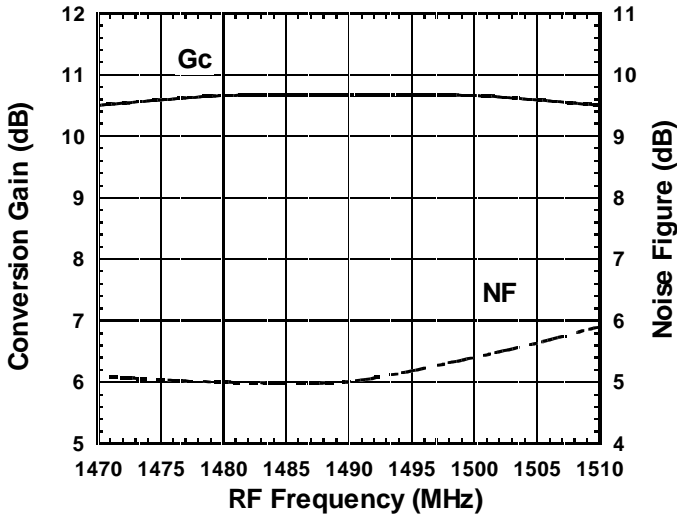

Condition
 $f_{IF}=130.05\text{MHz}$
 $f_{RF}=1470\sim 1510\text{MHz}$, $P_{RF}=-30\text{dBm}$
 $f_{LO}=1339.95\sim 1379.95\text{MHz}$, $P_{LO}=-15\text{dBm}$
 $V_{MIX}=V_{LO}=V_{INV}=2.8\text{V}$
 $V_{CTL}=2.4\text{V}$

Gc , NF vs. LO Power

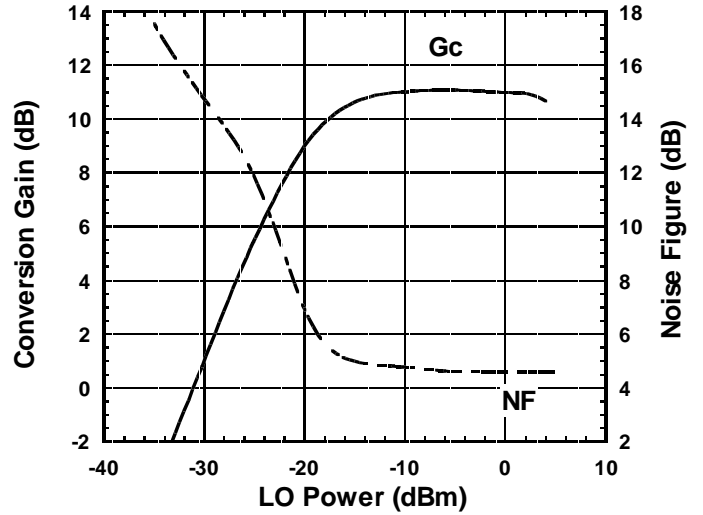

Condition
 $f_{IF}=130.05\text{MHz}$
 $f_{RF}=1489\text{MHz}$, $P_{RF}=-30\text{dBm}$
 $f_{LO}=1358.95\text{MHz}$
 $V_{MIX}=V_{LO}=V_{INV}=2.8\text{V}$
 $V_{CTL}=2.4\text{V}$

OIP3 , IIP3 vs. RF Frequency

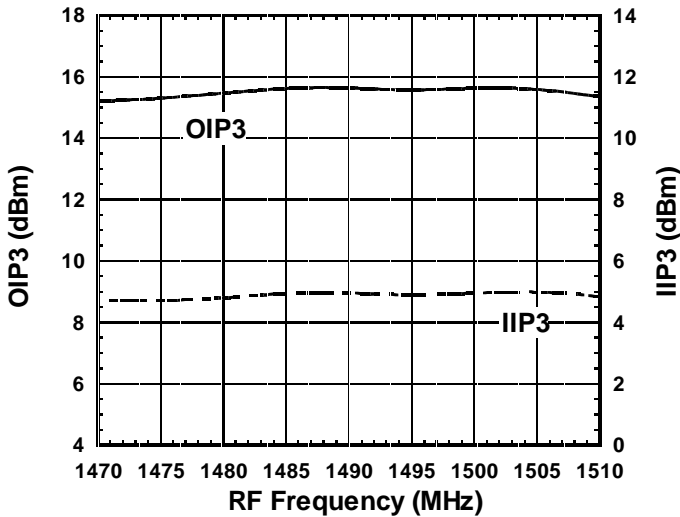

Condition
 $f_{IF}=130.05\text{MHz}$
 $f_{RF1}=1470\sim 1510\text{MHz}$
 $f_{RF2}=f_{RF1}+100\text{kHz}$, $P_{RF}=-30\text{dBm}$
 $f_{LO}=1339.95\sim 1379.95\text{MHz}$, $P_{LO}=-15\text{dBm}$
 $V_{MIX}=V_{LO}=V_{INV}=2.8\text{V}$
 $V_{CTL}=2.4\text{V}$

OIP3 , IIP3 vs. LO Power

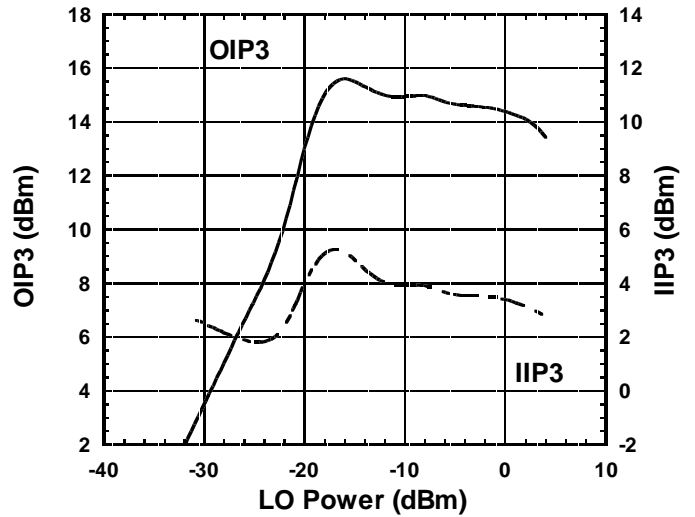

Condition
 $f_{IF}=130.05\text{MHz}$
 $f_{RF}=1489.0+1489.1\text{MHz}$, $P_{RF}=-30\text{dBm}$
 $f_{LO}=1358.95\text{MHz}$
 $V_{MIX}=V_{LO}=V_{INV}=2.8\text{V}$
 $V_{CTL}=2.4\text{V}$

NJG1560PB1

TYPICAL CHARACTERISTICS (1.5GHz Band)

IF Output Power vs. RF Power

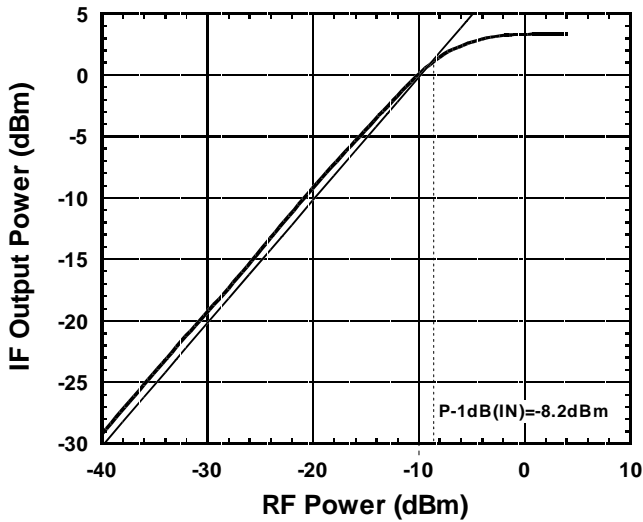

Condition
 $f_{IF}=130.05\text{MHz}$
 $f_{RF}=1489\text{MHz}$
 $f_{LO}=1358.95\text{MHz}$, $P_{LO}=-15\text{dBm}$
 $V_{MIX}=V_{LO}=V_{INV}=2.8\text{V}$
 $V_{CTL}=2.4\text{V}$

IF , IM3 vs. RF Power

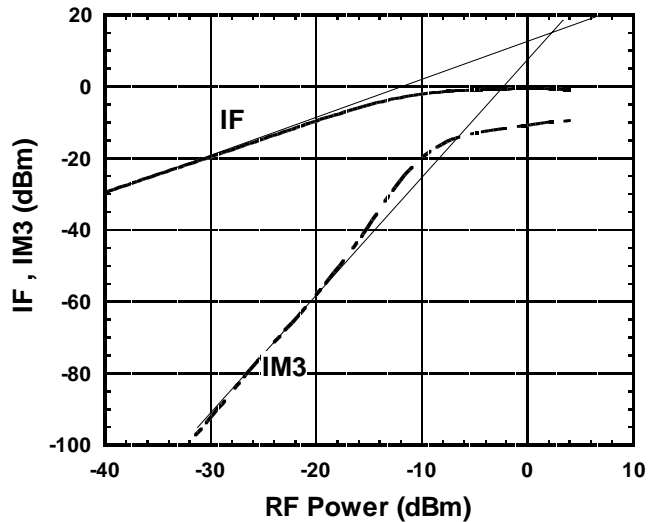

Condition
 $f_{IF}=130.05\text{MHz}$
 $f_{RF}=1489.0+1489.1\text{MHz}$
 $f_{LO}=1358.95\text{MHz}$, $P_{LO}=-15\text{dBm}$
 $V_{MIX}=V_{LO}=V_{INV}=2.8\text{V}$
 $V_{CTL}=2.4\text{V}$

LOCAL Leak Level vs. LO Frequency

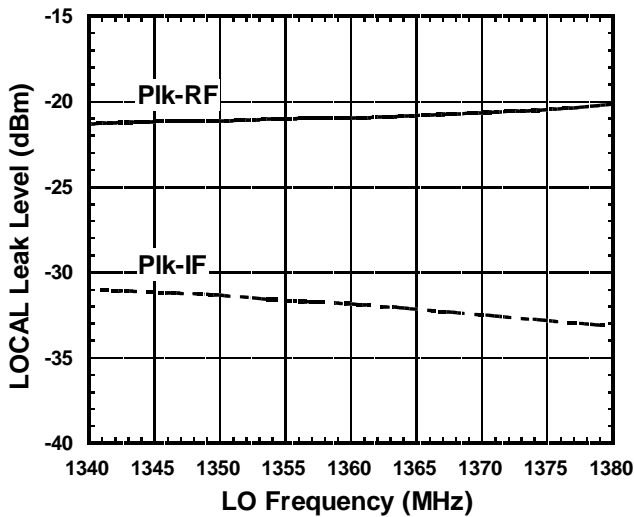

■ TYPICAL CHARACTERISTICS (1.5GHz Band)

G_c, NF vs. Ambient Temperature

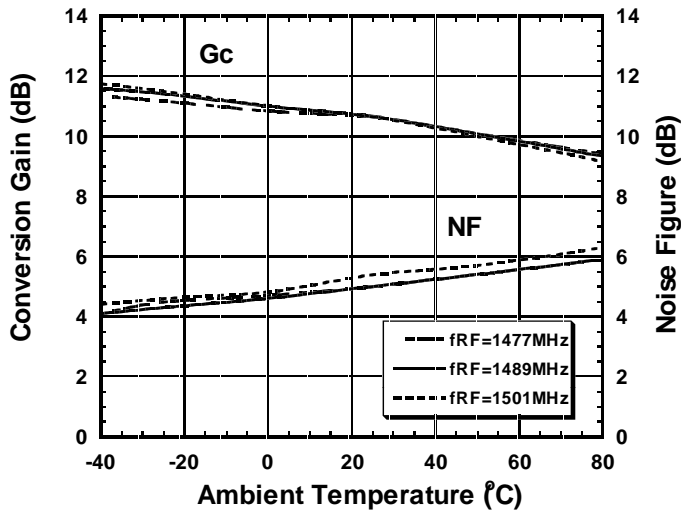

Condition
 $f_{IF}=130.05\text{MHz}$
 $f_{RF}=1477\sim 1501\text{MHz}$, $P_{RF}=-30\text{dBm}$
 $f_{LO}=1346.95\sim 1470.95\text{MHz}$, $P_{LO}=-15\text{dBm}$
 $V_{MIX}=V_{LO}=V_{INV}=2.8\text{V}$
 $V_{CTL}=2.4\text{V}$

OIP₃, IIP₃ vs. Ambient Temperature

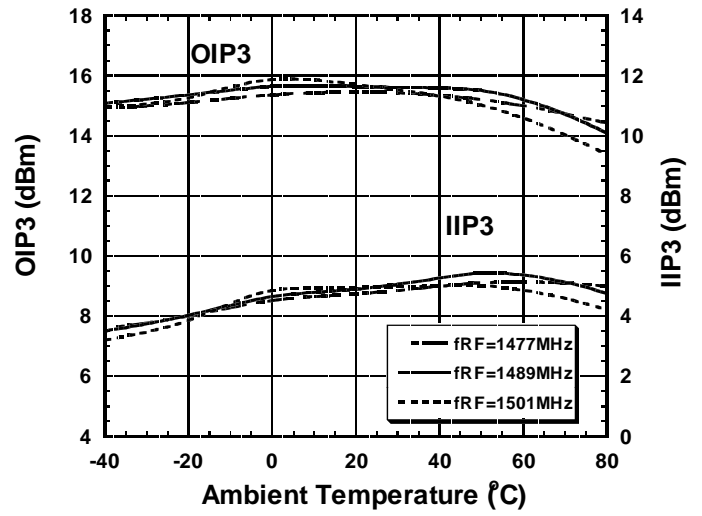

Condition
 $f_{IF}=130.05\text{MHz}$
 $f_{RF1}=1477\sim 1501\text{MHz}$,
 $f_{RF2}=f_{RF1}+100\text{kHz}$, $P_{RF}=-30\text{dBm}$
 $f_{LO}=1346.95\sim 1470.95\text{MHz}$, $P_{LO}=-15\text{dBm}$
 $V_{MIX}=V_{LO}=V_{INV}=2.8\text{V}$
 $V_{CTL}=2.4\text{V}$

P-1dB(IN) vs. Ambient Temperature

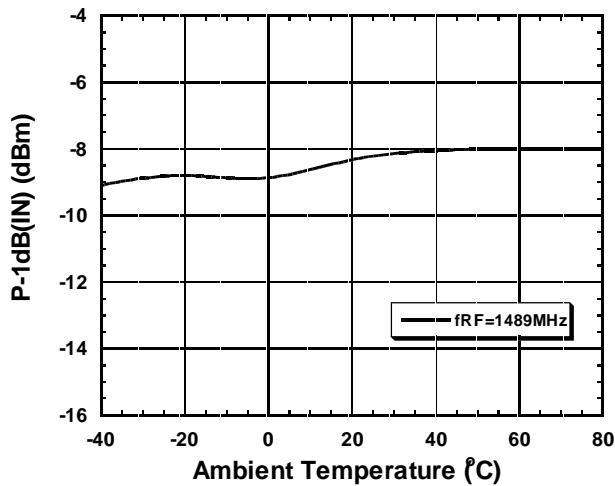

Condition
 $f_{IF}=130.05\text{MHz}$
 $f_{RF}=1489\text{MHz}$
 $f_{LO}=1358.95\text{MHz}$, $P_{LO}=-15\text{dBm}$
 $V_{MIX}=V_{LO}=V_{INV}=2.8\text{V}$
 $V_{CTL}=2.4\text{V}$

NJG1560PB1

TYPICAL CHARACTERISTICS (1.5GHz Band)

Conversion Gain vs. Frequency

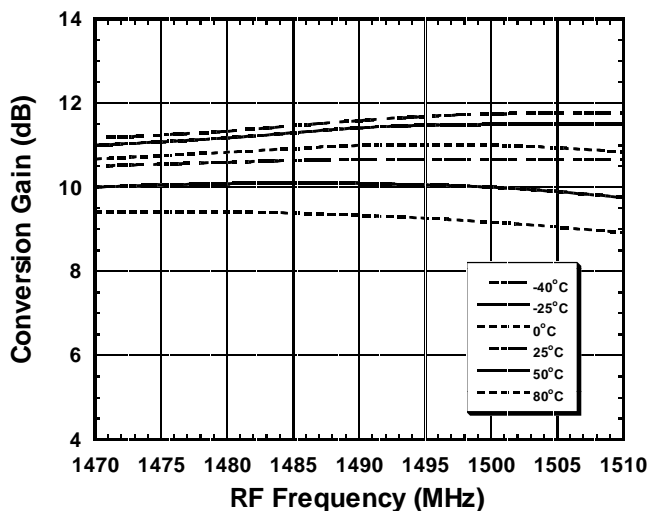

Noise Figure vs. Frequency

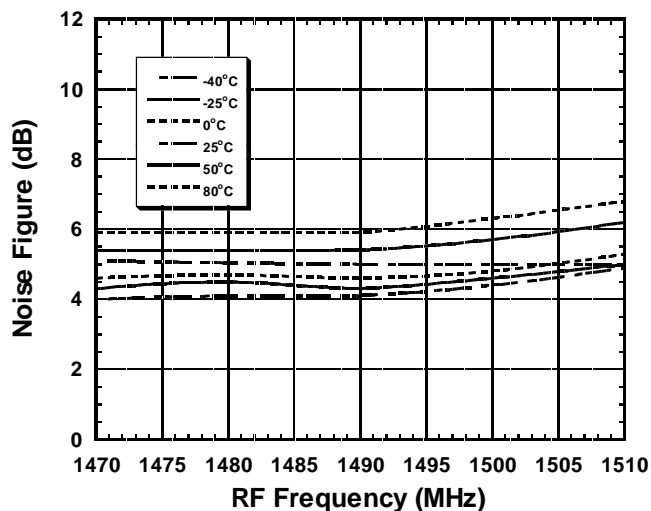

OIP3 vs. Frequency

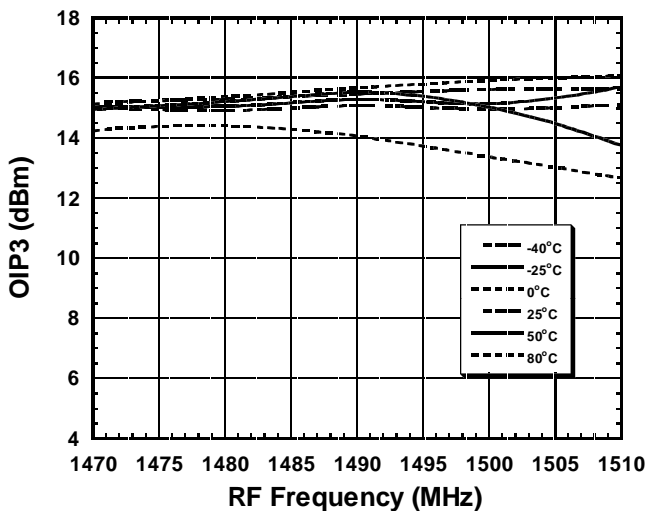

IIP3 vs. Frequency

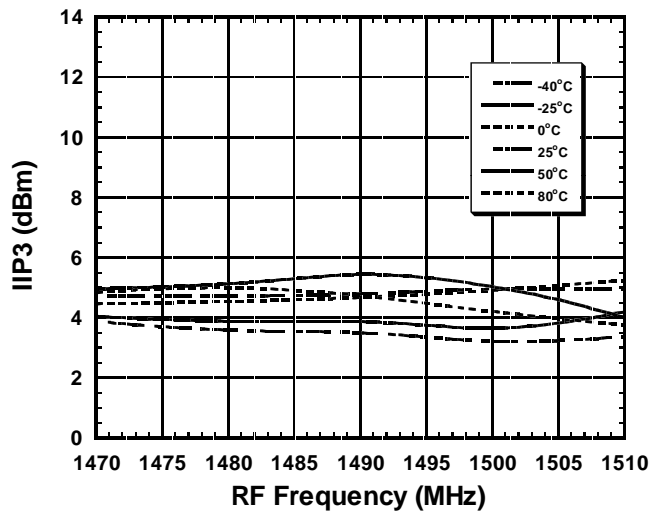

TYPICAL CHARACTERISTICS (1.5GHz Band)

Conversion Gain vs. LO Power

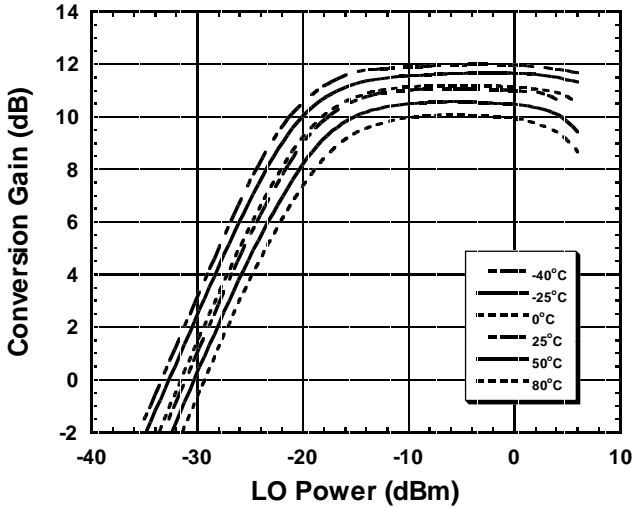

Condition
 $f_{IF}=130.05\text{MHz}$
 $f_{RF}=1489\text{MHz}$, $P_{RF}=-30\text{dBm}$
 $f_{LO}=1358.95\text{MHz}$
 $V_{MIX}=V_{LO}=V_{INV}=2.8\text{V}$
 $V_{CTL}=2.4\text{V}$

Noise Figure vs. LO Power

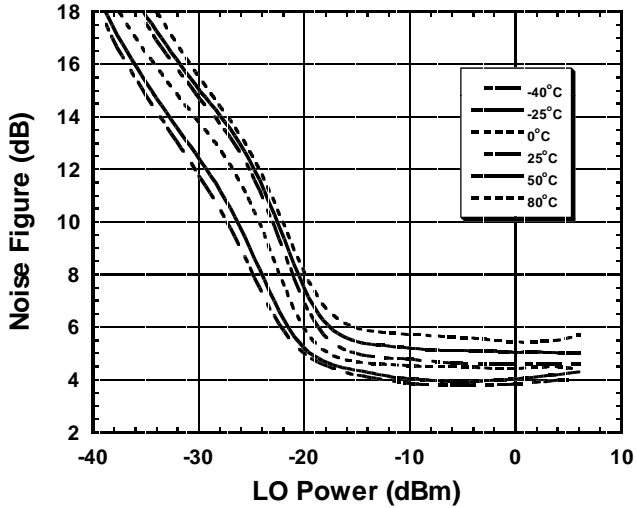

Condition
 $f_{IF}=130.05\text{MHz}$
 $f_{RF}=1489\text{MHz}$
 $f_{LO}=1358.95\text{MHz}$
 $V_{MIX}=V_{LO}=V_{INV}=2.8\text{V}$
 $V_{CTL}=2.4\text{V}$

OIP3 vs. LO Power

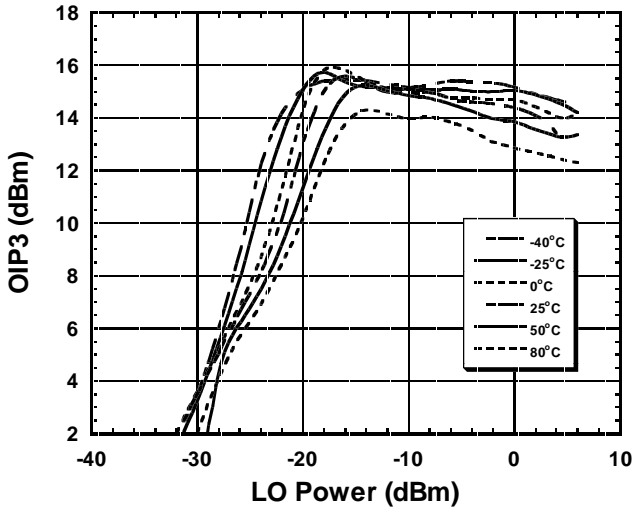

Condition
 $f_{IF}=130.05\text{MHz}$
 $f_{RF}=1489.0+1489.1\text{MHz}$, $P_{RF}=-30\text{dBm}$
 $f_{LO}=1358.95\text{MHz}$
 $V_{MIX}=V_{LO}=V_{INV}=2.8\text{V}$
 $V_{CTL}=2.4\text{V}$

IIP3 vs. LO Power

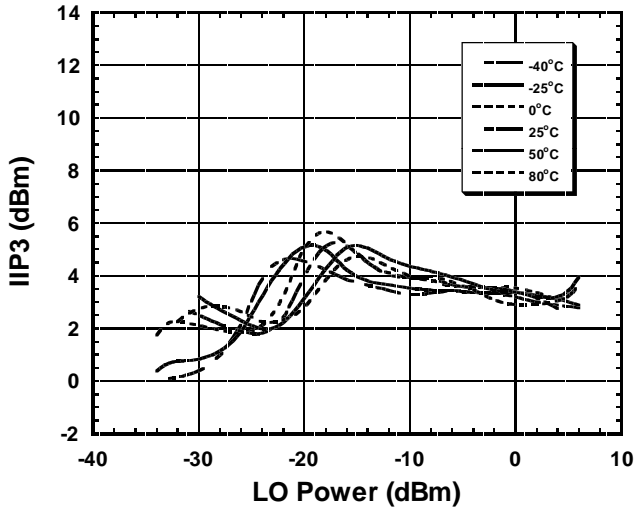

Condition
 $f_{IF}=130.05\text{MHz}$
 $f_{RF}=1489.0+1489.1\text{MHz}$, $P_{RF}=-30\text{dBm}$
 $f_{LO}=1358.95\text{MHz}$
 $V_{MIX}=V_{LO}=V_{INV}=2.8\text{V}$
 $V_{CTL}=2.4\text{V}$

APPLICATION CIRCUIT

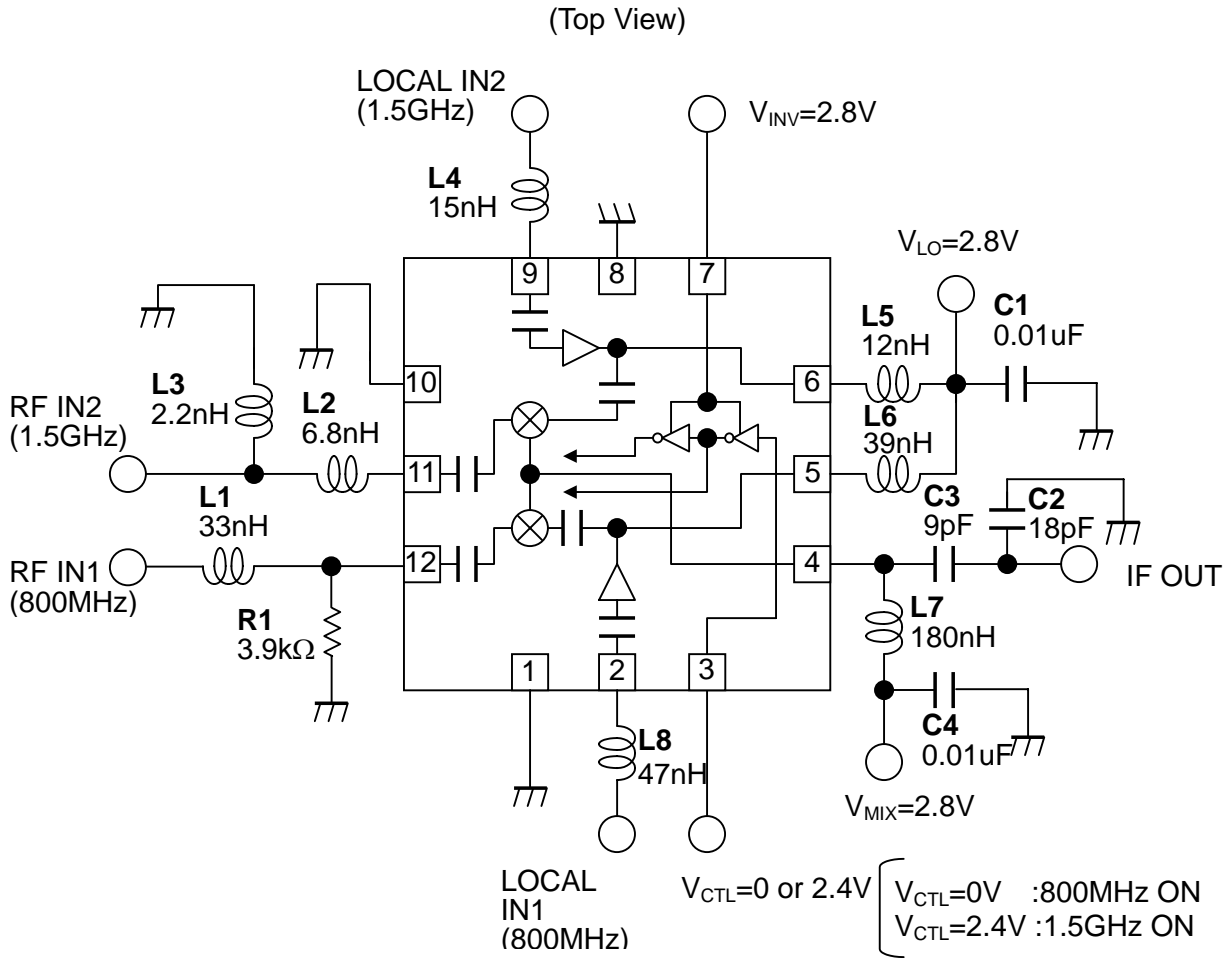

Parts list

PARTS ID	COMMENT
L1	TAIYO-YUDEN (HK1005, 1005size)
L2	TAIYO-YUDEN (HK1005, 1005size)
L3	TAIYO-YUDEN (HK1005, 1005size)
L4	TAIYO-YUDEN (HK1005, 1005size)
L5	TAIYO-YUDEN (HK1005, 1005size)
L6	TAIYO-YUDEN (HK1005, 1005size)
L7	TAIYO-YUDEN (HK1608, 1608size)
L8	TAIYO-YUDEN (HK1005, 1005size)
C1	MURATA (GRM36, 1005size)
C2	MURATA (GRM36, 1005size)
C3	MURATA (GRM36, 1005size)
C4	MURATA (GRM36, 1005size)
R1	1005 Size

NJG1560PB1

RECOMMENDED PCB DESIGN

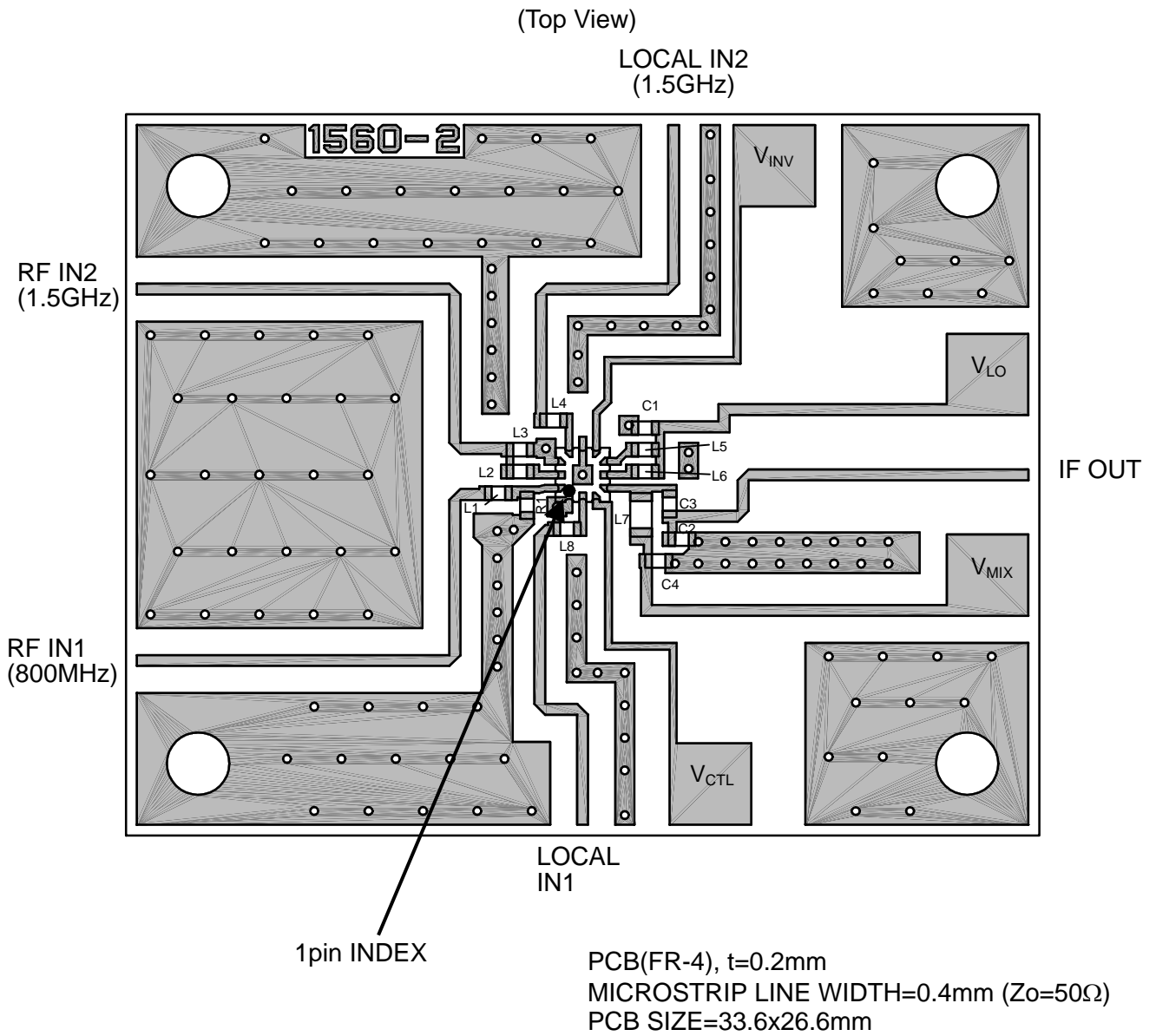

PRECAUTIONS

1. Please locate L6 close to VLO1 terminal (5).
2. Please locate L5 close to VLO2 terminal (6).
3. Please locate C1 close to L5 and L6.
4. Please locate C4 close to L7.

MEASURING BLOCK DIAGRAM

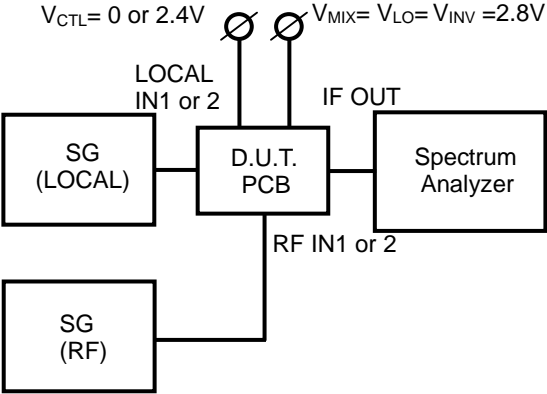

Conversion Gain Measuring Block Diagram

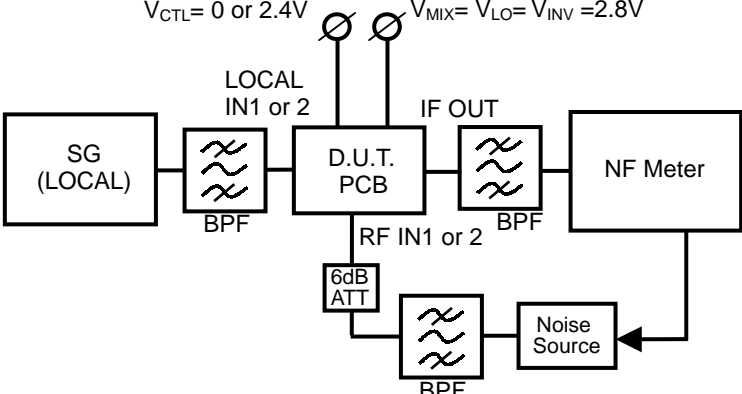

Noise Figure Measuring Block Diagram

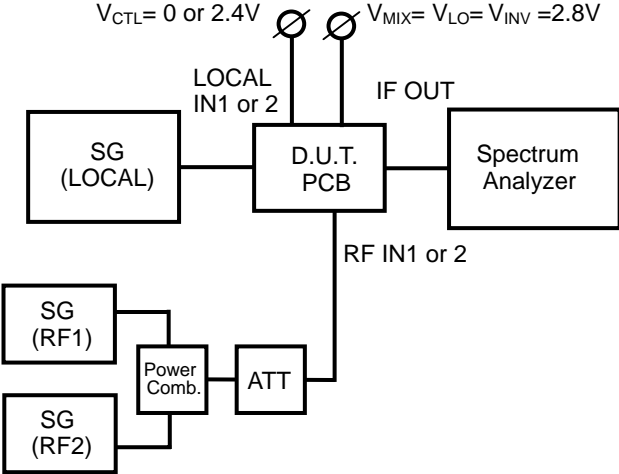

OIP3, IIP3 Measuring Block Diagram

NJG1560PB1

PACKAGE OUTLINE (FFP12-B1)

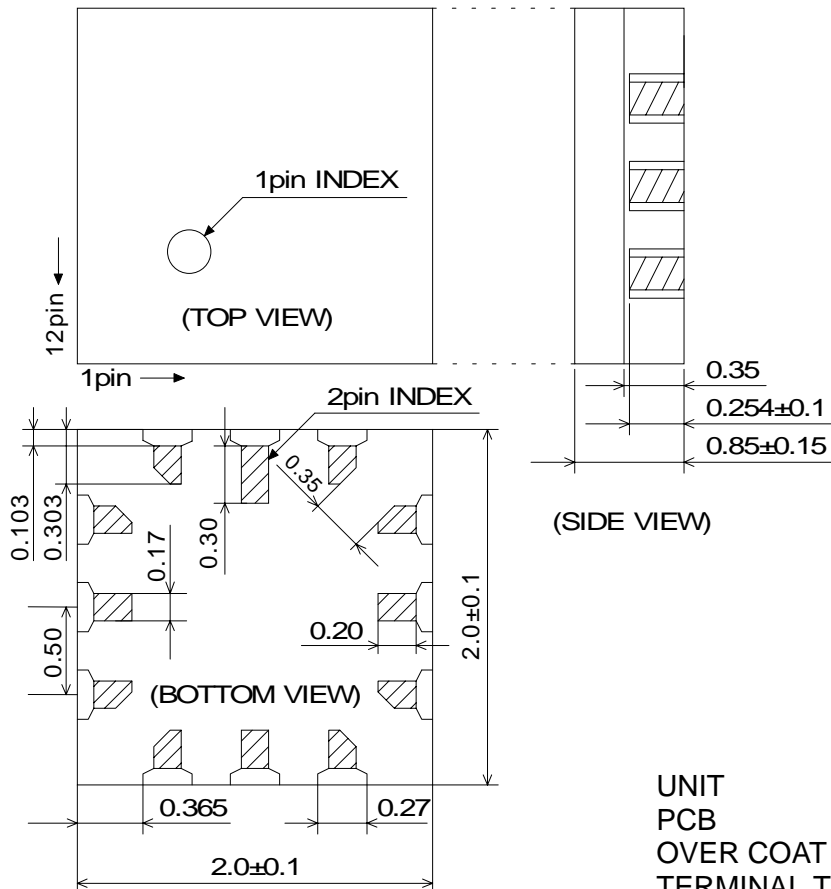

UNIT	: mm
PCB	: Ceramic
OVER COAT	: Epoxy resin
TERMINAL TREAT	: Au
WEIGHT	: 10mg

Cautions on using this product

- This product contains Gallium-Arsenide (GaAs) which is a harmful material.
- Do NOT eat or put into mouth.
 - Do NOT dispose in fire or break up this product.
 - Do NOT chemically make gas or powder with this product.
 - To waste this product, please obey the relating law of your country.

[CAUTION]

The specifications on this databook are only given for information, without any guarantee as regards either mistakes or omissions. The application circuits in this databook are described only to show representative usages of the product and not intended for the guarantee or permission of any right including the industrial rights.

This product may be damaged with electric static discharge (ESD) or spike voltage. Please handle with care to avoid these damages.

Mouser Electronics

Authorized Distributor

Click to View Pricing, Inventory, Delivery & Lifecycle Information:

[NJR:](#)

[NJG1560PB1-TE2](#) [NJG1560PB1-TE1](#)



Компания «ЭлектроПласт» предлагает заключение долгосрочных отношений при поставках импортных электронных компонентов на взаимовыгодных условиях!

Наши преимущества:

- Оперативные поставки широкого спектра электронных компонентов отечественного и импортного производства напрямую от производителей и с крупнейших мировых складов;
- Поставка более 17-ти миллионов наименований электронных компонентов;
- Поставка сложных, дефицитных, либо снятых с производства позиций;
- Оперативные сроки поставки под заказ (от 5 рабочих дней);
- Экспресс доставка в любую точку России;
- Техническая поддержка проекта, помощь в подборе аналогов, поставка прототипов;
- Система менеджмента качества сертифицирована по Международному стандарту ISO 9001;
- Лицензия ФСБ на осуществление работ с использованием сведений, составляющих государственную тайну;
- Поставка специализированных компонентов (Xilinx, Altera, Analog Devices, Intersil, Interpoint, Microsemi, Aeroflex, Peregrine, Syfer, Eurofarad, Texas Instrument, Miteq, Cobham, E2V, MA-COM, Hittite, Mini-Circuits, General Dynamics и др.);

Помимо этого, одним из направлений компании «ЭлектроПласт» является направление «Источники питания». Мы предлагаем Вам помощь Конструкторского отдела:

- Подбор оптимального решения, техническое обоснование при выборе компонента;
- Подбор аналогов;
- Консультации по применению компонента;
- Поставка образцов и прототипов;
- Техническая поддержка проекта;
- Защита от снятия компонента с производства.



Как с нами связаться

Телефон: 8 (812) 309 58 32 (многоканальный)

Факс: 8 (812) 320-02-42

Электронная почта: org@eplast1.ru

Адрес: 198099, г. Санкт-Петербург, ул. Калинина, дом 2, корпус 4, литера А.