

Snap Action Switch

V

General Purpose Snap Action Switch

- Industry standard design with switching currents of 10A to 21A
- Widely used for applications where long life expectancy and high reliability is required.
- Choose from a variety of levers, terminals and operating forces.
- Right and Left Barrier options are available for the V-21 and V-16 models
- Heat resistant versions of the V-15 and V-10 are available.
- RoHS Compliant



Ordering Information

Model Number Legend

V - - - -

1 2 3 4 5 6 7 8 9

- | | | |
|--|--|---|
| <p>1. Ratings</p> <p>21: 21 A at 250 VAC 16: 16 A at 250 VAC 15: 15 A at 250 VAC 11: 11 A at 250 VAC 10: 10 A at 250 VAC</p> <p>2. Contact Gap</p> <p>None: 1 mm (F gap) G: 0.5 mm (G gap)</p> <p>3. Actuator</p> <p>None: Pin plunger</p> <p>1: Short hinge lever 2: Hinge lever 3: Long hinge lever 4: Simulated roller lever 5: Short hinge roller lever 6: Hinge roller lever</p> | <p>4. Contact Form</p> <p>COM Terminal, Bottom position:</p> <p>1: SPDT 2: SPST-NC 3: SPST-NO</p> <p>COM Terminal, Side position:</p> <p>4: SPDT 5: SPST-NC 6: SPST-NO</p> <p>5. Terminals</p> <p>A: Solder terminals C2: Quick-connect terminal (#187) C: Quick-connect terminal (#250)</p> <p>6. Insulation Barrier</p> <p>None: Without Barrier R: Right-hand barrier L: Left-hand barrier (Barriers available for V-21 and V-16, only)</p> | <p>7. Maximum Operating Force</p> <p>6: 400 gf 5: 200 gf 4: 100 gf</p> <p>Note: These OF values are for the pin plunger models.</p> <p>8. Special Purpose</p> <p>None: Standard T: Heat resistive (V-15 and V-10, only)</p> <p>9. Mounting Hole Size</p> <p>None: 3.1 mm K: 2.9 mm</p> |
|--|--|---|

Note: Consult Omron regarding nomenclature combinations and part numbers not found in this datasheet.

Available Combinations

| | | | | Thermoplastic case | | | | Thermosetting case | | | | | |
|-----------------------|--------------------|------------------------|------------------------------------|--------------------|--------|--------|--------|--------------------|--------|--------|--------|------|--|
| | | | | Model | | V-21 | V-16 | | V-11 | V-15 | | V-10 | |
| | | | | Rated Current | | 21 A | 16 A | | 11 A | 15 A | | 10 A | |
| COM terminal position | Insulation Barrier | Heat Resistance | OF Terminal Symbol | 400 gf | 400 gf | 200 gf | 100 gf | 400 gf | 200 gf | 200 gf | 100 gf | | |
| Bottom | No | Standard (80°C) | Solder terminals (A) | --- | ○ | ○ | ○ | ○ | ○ | ○ | ○ | | |
| | | | Quick-connect terminals (#187)(C2) | --- | ○ | ○ | ○ | ○ | ○ | ○ | ○ | | |
| | | | Quick-connect terminals (#250)(C) | ○ | ○ | ○ | ○ | ○ | ○ | ○ | ○ | | |
| | | Heat resistant (150°C) | Solder terminals (A) | --- | --- | --- | --- | ○ | ○ | ○ | ○ | | |
| | | | Quick-connect terminals (#187)(C2) | --- | --- | --- | --- | ○ | ○ | ○ | ○ | | |
| | | | Quick-connect terminals (#250)(C) | --- | --- | --- | --- | --- | --- | --- | --- | | |
| | Yes | Standard (80°C) | Solder terminals (A) | --- | ○ | ○ | --- | --- | --- | --- | --- | | |
| | | | Quick-connect terminals (#187)(C2) | --- | ○ | ○ | --- | --- | --- | --- | --- | | |
| | | | Quick-connect terminals (#250)(C) | ○ | ○ | ○ | --- | --- | --- | --- | --- | | |
| Side | No | Standard (80°C) | Solder terminals (A) | --- | --- | --- | --- | ○ | ○ | ○ | ○ | | |
| | | | Quick-connect terminals (#187)(C2) | --- | --- | --- | --- | ○ | ○ | ○ | ○ | | |
| | | | Quick-connect terminals (#250)(C) | ○ | --- | --- | --- | --- | --- | --- | --- | | |

Note: 1. ○: Available model.

Consult OMRON for specific models with standard approval.

List of Models

Thermoplastic Case

21 A (OF: 400 gf)

| Common terminal position | Contact form | Terminal style | Actuator | Without barrier | Right-hand barrier | Left-hand barrier | |
|--|--------------|--------------------------|---|--|--|---|------------|
| | | | |  |  |  | |
| Bottom | SPDT | Quick-connect (#250) (C) | Pin plunger  | V-21-1C6 | V-21-1CR6 | V-21-1CL6 | |
| | | | | V-21-2C6 | V-21-2CR6 | V-21-2CL6 | |
| | | | | V-21-3C6 | V-21-3CR6 | V-21-3CL6 | |
| | SPDT | | Short hinge lever  | V-211-1C6 | V-211-1CR6 | V-211-1CL6 | |
| | | | | Hinge lever  | V-212-1C6 | V-212-1CR6 | V-212-1CL6 |
| | | | | | Long hinge lever  | V-213-1C6 | V-213-1CR6 |
| | | | | Simulated roller lever  | V-214-1C6 | V-214-1CR6 | V-214-1CL6 |
| | | | | Short hinge roller lever  | V-215-1C6 | V-215-1CR6 | V-215-1CL6 |
| Hinge roller lever  | V-216-1C6 | V-216-1CR6 | V-216-1CL6 | | | | |

Note: 1. Add "G" to the part number in the appropriate location to obtain a 0.5 mm contact gap. Add "K" to the part number in the appropriate location to obtain 2.9 mm mounting holes. Example: V-21 G2-1C6-K

2. Not all combinations are available. Consult Omron regarding nomenclature combinations and part numbers not found in this datasheet.

16 A (OF: 200 gf)

| Common terminal position | Contact form | Terminal style | Actuator | Without barrier | Right-hand barrier | Left-hand barrier | |
|--------------------------|--------------|---|--|--|---|---|-------------|
| | | | |  |  |  | |
| Bottom | SPDT | A | Pin plunger  | V-16-1A5 | V-16-1AR5 | V-16-1AL5 | |
| | | C2 | | V-16-1C25 | V-16-1C2R5 | V-16-1C2L5 | |
| | | C | | V-16-1C5 | --- | --- | |
| | SPST-NC | A | | V-16-2A5 | V-16-2AR5 | V-16-2AL5 | |
| | | C2 | | V-16-2C25 | V-16-2C2R5 | V-16-2C2L5 | |
| | | C | | V-16-2C5 | --- | --- | |
| | SPST-NO | A | | V-16-3A5 | V-16-3AR5 | V-16-3AL5 | |
| | | C2 | | V-16-3C25 | V-16-3C2R5 | V-16-3C2L5 | |
| | | C | | V-16-3C5 | --- | --- | |
| | SPDT | A | Short hinge lever  | V-161-1A5 | V-161-1AR5 | V-161-1AL5 | |
| | | | | C2 | V-161-1C25 | V-161-1C2R5 | V-161-1C2L5 |
| | | | | C | V-161-1C5 | --- | --- |
| | | A | Hinge lever  | V-162-1A5 | V-162-1AR5 | V-162-1AL5 | |
| | | | | C2 | V-162-1C25 | V-162-1C2R5 | V-162-1C2L5 |
| | | | | C | V-162-1C5 | --- | --- |
| | | A | Long hinge lever  | V-163-1A5 | V-163-1AR5 | V-163-1AL5 | |
| | | | | C2 | V-163-1C25 | V-163-1C2R5 | V-163-1C2L5 |
| | | | | C | V-163-1C5 | --- | --- |
| | | A | Simulated roller lever  | V-164-1A5 | V-164-1AR5 | V-164-1AL5 | |
| | | | | C2 | V-164-1C25 | V-164-1C2R5 | V-164-1C2L5 |
| | | | | C | V-164-1C5 | --- | --- |
| | | A | Short hinge roller lever  | V-165-1A5 | V-165-1AR5 | V-165-1AL5 | |
| | | | | C2 | V-165-1C25 | V-165-1C2R5 | V-165-1C2L5 |
| | | | | C | V-165-1C5 | --- | --- |
| A | | Hinge roller lever  | V-166-1A5 | V-166-1AR5 | V-166-1AL5 | | |
| | | | C2 | V-166-1C25 | V-166-1C2R5 | V-166-1C2L5 | |
| | | | C | V-166-1C5 | --- | --- | |

11 A (OF: 100 gf)

| Common terminal position | Contact form | Terminal style | Actuator | Without barrier |
|--------------------------|--------------|----------------|---|---|
| | | | |  |
| Bottom | SPDT | A | Pin plunger  | V-11-1A4 |
| | | C2 | | V-11-1C24 |
| | | C | | V-11-1C4 |
| | | A | Short hinge lever  | V-111-1A4 |
| | | C2 | | V-111-1C24 |
| | | C | | V-111-1C4 |
| | | A | Hinge lever  | V-112-1A4 |
| | | C2 | | V-112-1C24 |
| | | C | | V-112-1C4 |
| | | A | Long hinge lever  | V-113-1A4 |
| | | C2 | | V-113-1C24 |
| | | C | | V-113-1C4 |
| | | A | Simulated roller lever  | V-114-1A4 |
| | | C2 | | V-114-1C24 |
| | | C | | V-114-1C4 |
| | | A | Short hinge roller lever  | V-115-1A4 |
| | | C2 | | V-115-1C24 |
| | | C | | V-115-1C4 |
| | | A | Hinge roller lever  | V-116-1A4 |
| | | C2 | | V-116-1C24 |
| | | C | | V-116-1C4 |

- Note:** 1. Add "G" to the part number in the appropriate location to obtain a 0.5 mm contact gap. Add "K" to the part number in the appropriate location to obtain 2.9 mm mounting holes. Examples: 1) V-16G3-1C25-K 2) V-11G-1A4-K
 2. Not all combinations are available. Consult Omron regarding nomenclature combinations and part numbers not found in this datasheet.

Thermosetting Case

Standard models - 15 A / 10 A

| Common terminal position | Contact form | Terminal style | Actuator | 15 A | 10 A | | |
|--------------------------|--------------|----------------|--|---------------|---------------|---------------|-------------|
| | | | | 200 gf | 200 gf | 100 gf | |
| Bottom | SPDT | A | Pin plunger  | V-15G-1A5-K | V-10G-1A5-K | V-10G-1A4-K | |
| | | C2 | | V-15G-1C25-K | V-10G-1C25-K | V-10G-1C24-K | |
| | | C | | V-15G-1C5-K | — | — | |
| | SPST-NC | A | | V-15G-2A5-K | V-10G-2A5-K | V-10G-2A4-K | |
| | | C2 | | V-15G-2C25-K | V-10G-2C25-K | V-10G-2C24-K | |
| | | C | | V-15G-3A5-K | V-10G-3A5-K | V-10G-3A4-K | |
| | SPST-NO | A | | V-15G-3C25-K | V-10G-3C25-K | V-10G-3C24-K | |
| | | C2 | | V-15G-3C5-K | — | — | |
| | | C | | V-15G-4A5-K | V-10G-4A5-K | V-10G-4A4-K | |
| | Side | SPDT | | A | V-15G-5A5-K | V-10G-5A5-K | V-10G-5A4-K |
| | | SPST-NC | | | V-15G-6A5-K | V-10G-6A5-K | V-10G-6A4-K |
| | | SPST-NO | | | V-15G-6A5-K | V-10G-6A5-K | V-10G-6A4-K |
| Bottom | SPDT | A | Short hinge lever  | V-15G1-1A5-K | V-10G1-1A5-K | V-10G1-1A4-K | |
| | | C2 | | V-15G1-1C25-K | V-10G1-1C25-K | V-10G1-1C24-K | |
| | | A | Hinge lever  | V-15G2-1A5-K | V-10G2-1A5-K | V-10G2-1A4-K | |
| | | C2 | | V-15G2-1C25-K | V-10G2-1C25-K | V-10G2-1C24-K | |
| | | A | Long hinge lever  | V-15G3-1A5-K | V-10G3-1A5-K | V-10G3-1A4-K | |
| | | C2 | | V-15G3-1C25-K | V-10G3-1C25-K | V-10G3-1C24-K | |
| | | A | Simulated roller lever  | V-15G4-1A5-K | V-10G4-1A5-K | V-10G4-1A4-K | |
| | | C2 | | V-15G4-1C25-K | V-10G4-1C25-K | V-10G4-1C24-K | |
| | | A | Short hinge roller lever  | V-15G5-1A5-K | V-10G5-1A5-K | V-10G5-1A4-K | |
| | | C2 | | V-15G5-1C25-K | V-10G5-1C25-K | V-10G5-1C24-K | |
| | | A | Hinge roller lever  | V-15G6-1A5-K | V-10G6-1A5-K | V-10G6-1A4-K | |
| | | C2 | | V-15G6-1C25-K | — | V-10G6-1C24-K | |

Note: 1. For SPST-NC and SPST-NO with levers consult Omron.

2. Not all combinations are available. Consult Omron regarding nomenclature combinations and part numbers not found in this datasheet.

Heat Resistant Models (Up to 150°C) - 15 A / 10A

| Common terminal position | Contact form | Terminal style | Actuator | 15 A | 10 A |
|--------------------------|--------------|----------------------|--|-------------|-------------|
| | | | | 200 gf | 100 gf |
| Bottom | SPDT | Solder Terminals (A) | Pin plunger  | V-15-1A5-T | V-10-1A4-T |
| | | | Short hinge lever  | V-151-1A5-T | V-101-1A4-T |
| | | | Hinge lever  | V-152-1A5-T | V-102-1A4-T |
| | | | Long hinge lever  | V-153-1A5-T | V-103-1A4-T |
| | | | Simulated roller lever  | V-154-1A5-T | V-104-1A4-T |
| | | | Short hinge roller lever  | V-155-1A5-T | V-105-1A4-T |
| | | | Hinge roller lever  | V-156-1A5-T | V-106-1A4-T |

Note: 1. Add "G" to the part number in the appropriate location to obtain a 0.5 mm contact gap. Add "-K" to the part number in the appropriate location to obtain 2.9 mm mounting holes. Add "C2" to the part number in the appropriate location to obtain versions with #187 quick-connect terminals. Example: 1) V-15G1-1C25-T-K

2. Not all combinations are available. Consult Omron regarding nomenclature combinations and part numbers not found in this datasheet.

Specifications

■ Ratings (reference values)

| Type | Rated voltage | Non-inductive load | | | | Inductive load | | | |
|------|---------------|--------------------|----|-----------|----|----------------|----|------------|----|
| | | Resistive load | | Lamp load | | Inductive load | | Motor load | |
| | | NC | NO | NC | NO | NC | NO | NC | NO |
| V-21 | 250 VAC | 21 A | | 3 A | | 12 A | | 4 A | |
| | 8 VDC | 21 A | | 5 A | | 12 A | | 7 A | |
| | 30 VDC | 14 A | | 5 A | | 12 A | | 5 A | |
| | 125 VDC | 0.6 A | | 0.1 A | | 0.6 A | | 0.1 A | |
| | 250 VDC | 0.3 A | | 0.05 A | | 0.3 A | | 0.05 A | |
| V-16 | 250 VAC | 16 A | | 2 A | | 10 A | | 3 A | |
| | 8 VDC | 16 A | | 4 A | | 10 A | | 6 A | |
| | 30 VDC | 10 A | | 4 A | | 10 A | | 4 A | |
| | 125 VDC | 0.6 A | | 0.1 A | | 0.6 A | | 0.1 A | |
| | 250 VDC | 0.3 A | | 0.05 A | | 0.3 A | | 0.05 A | |
| V-15 | 250 VAC | 15 A | | 2 A | | 10 A | | 3 A | |
| | 8 VDC | 15 A | | 4 A | | 10 A | | 6 A | |
| | 30 VDC | 10 A | | 4 A | | 10 A | | 4 A | |
| | 125 VDC | 0.6 A | | 0.1 A | | 0.6 A | | 0.1 A | |
| | 250 VDC | 0.3 A | | 0.05 A | | 0.3 A | | 0.05 A | |
| V-11 | 250 VAC | 11 A | | 1.5 A | | 6 A | | 2 A | |
| | 8 VDC | 11 A | | 3 A | | 6 A | | 3 A | |
| | 30 VDC | 6 A | | 3 A | | 6 A | | 3 A | |
| | 125 VDC | 0.6 A | | 0.1 A | | 0.6 A | | 0.1 A | |
| | 250 VDC | 0.3 A | | 0.05 A | | 0.3 A | | 0.05 A | |
| V-10 | 250 VAC | 10 A | | 1.5 A | | 6 A | | 2 A | |
| | 8 VDC | 10 A | | 3 A | | 6 A | | 3 A | |
| | 30 VDC | 6 A | | 3 A | | 6 A | | 3 A | |
| | 125 VDC | 0.6 A | | 0.1 A | | 0.6 A | | 0.1 A | |
| | 250 VDC | 0.3 A | | 0.05 A | | 0.3 A | | 0.05 A | |

- Note:**
1. The above current values are the normal current values of models with a contact gap of 1 mm (gap F), which vary with the normal current values of models with a contact gap of 0.5 mm (gap G).
 2. Inductive load has a power factor of 0.4 min. (AC) and a time constant of 7 ms max. (DC).
 3. Lamp load has an inrush current of 10 times the steady-state current.
 4. Motor load has an inrush current of 6 times the steady-state current.
 5. The ratings values apply under the following test conditions: Ambient temperature: 20±2°C, Ambient humidity: 65±5%, Operating frequency: 30 operations/min

■ Approved Standards

UL1054 (File No. E41515)

CSA C22.2 No.55 (File No. LR21642)

| Rated voltage | V-21 | V-16 | V-15 | V-11 | V-10 |
|---------------|--------------|--------------|--------------|--------------|--------------|
| 125 VAC | 21 A, 1/2 HP | 16 A, 1/2 HP | 15 A, 1/2 HP | 11 A, 1/3 HP | 10 A, 1/3 HP |
| 250 VAC | | | | | |
| 125 VDC | 0.6 A | | | | |
| 250 VDC | 0.3 A | | | | |

EN 61058-1 (File No. 129608, VDE approval)

| Rated voltage | V-21 | V-16 | V-11 |
|---------------|----------|----------|----------|
| 250 VAC | 20 (4) A | 16 (4) A | 11 (3) A |

Testing conditions: 5E4 (50,000 operations), T105 (0°C to 105°C)

EN 61058-1 (File No. T9451451, TÜV Rheinland approval)

| Rated voltage | V-15 | V-10 |
|---------------|-------|------|
| 250 VAC | 15 A | 10 A |
| 250 VDC | 0.3 A | |

Testing conditions: 5E4 (50,000 operations), T85 (0°C to 85°C)

■ Characteristics

| | |
|--|--|
| Operating speed | 0.1 mm to 1 m/s (plunger models) |
| Operating frequency | Mechanical: 600 operations/minute, max. Electrical: 30 operations/minute, max. |
| Insulation resistance | 100 MΩ min. (at 500 VDC) |
| Contact resistance | 15 mΩ max. |
| Dielectric strength (see note 2) | 1,000 VAC, 50/60 Hz for 1 min between terminals of the same polarity V-21, V-16 and V-11: 2,000 VAC, 50/60 Hz for 1 min between current-carrying metal parts and ground, and between each terminal and non-current-carrying metal parts V-15 and V-10: 1,500 VAC, 50/60 Hz for 1 min between current-carrying metal parts and ground, and between each terminal and non-current-carrying metal parts |
| Vibration resistance (see note 3) | Malfunction: 10 to 55 Hz, 1.5-mm double amplitude |
| Shock resistance (see note 3) | Destruction: 1,000 m/s ² (approx. 100G) max. Malfunction: V-21/V-16/V-15: 300 m/s ² (approx. 30G) max. V-11/V10: 200 m/s ² (approx. 20G) max. |
| Life expectancy | Mechanical: 50,000,000 operations min. (60 operations/minute) Electrical: V-21/V-16/V-15: 100,000 operations min. (30 operations/minute) (V-15 heat resistive: 20,000 operations min. (30 ops/minute)) V-11/V-10: 300,000 operations min. (30 operations/minute) (V-10 heat resistive: 50,000 operations min. (30 ops/minute)) |
| Degree of protection | IEC IP40 |
| Degree of protection against electric shock | Class I |
| Proof tracking index (PTI) | 175 |
| Ambient operating temperature | -25°C to 80°C (at 60% RH max.) with no icing -25°C to 150°C for heat resistive models (at 60% RH max.) with no icing. |
| Ambient operating humidity | 85% max. (for 5°C to 35°C) |
| Weight | Approx. 6.2 g (plunger models) |

Note: 1. Data shown are of initial value.

2. The dielectric strength shown is measured using a separator between the switch and metal mounting plate.

3. For pin plunger models, the above values apply for use at both the free position and total travel position. For lever models, they apply at the total travel position.

4. For testing conditions, contact your OMRON sales representative.

■ Contact Specifications

| Item | | V-21 | V-16 | V-15 | V-11 | V-10 |
|-------------------------|----------------------|--|-----------|-----------|-----------|--------|
| Contact | Specification | Rivet | | | | |
| | Material | Silver alloy | | | | Silver |
| | Gap (standard value) | 1 mm (F gap type) or 0.5 mm (G gap type) | | | | |
| Inrush current | NC | 50 A max. | 40 A max. | 36 A max. | 24 A max. | |
| | NO | | | | | |
| Minimum applicable load | | 160 mA at 5 VDC | | | | |

Note: Minimum applicable loads are indicated by N standard reference values. This value represents the failure rate at a 60% (λ_{60}) reliability level (JIS C5003). The equation $\lambda_{60}=0.5 \times 10^{-6}$ / operations indicates that a failure rate of 1/2,000,000 operations can be expected at a reliability level of 60%

Engineering Data

■ Mechanical service life

(Pin plunger models)

V-21/-16/-15/-10



■ Electrical service life

(Pin plunger models)

V-21/-16/-15



V-11/-10



■ Contact Form

| Common terminal position | Contact form | | |
|--------------------------|--------------|----------|----------|
| | SPDT | SPST-NC* | SPST-NO* |
| Bottom type | | | |
| Side type | | | |

* The SPST-NC and SPST-NO contact form types listed in the ordering information tables are for Pin Plunger models only. For information concerning lever models consult Omron.

■ Barrier direction (V-21 and V-16)

Right-hand Barrier

Left-hand Barrier



■ Mounting Holes

All switches may be panel mounted using M3 mounting screws with plane washers or spring washers to securely mount the switch. Tighten the screws to a torque of 0.39 to 0.59 N·m.



Dimensions

■ Terminals

- Note:** 1. Unless otherwise specified, all units are in millimeters and a tolerance of ± 0.4 mm applies to all dimensions
2. The following table is for the SPDT contact specifications. Two terminals will be available for SPST-NO or SPST-NC contact specifications. For terminal positions, refer to the above *Contact Form*
3. Right-angle PCB terminal type is available with some models (not shown). Drawings will be provided if requested.
- D5: Pins at right angles, to the right
- D6: Pins at right angle, to the left

| Terminal type | Solder Terminal (A) | Quick-connect Terminal (#187) (C2) | Quick-connect Terminal (#250) (C) |
|---------------------|---|--|--|
| COM bottom position | <p>t = 0.5 Three, solder terminals</p> | <p>t = 0.5 Three, quick-connect terminals (#187)</p> | <p>t = 0.8 Three, quick-connect terminals (#250)</p> |
| COM side position | | | |
| Terminal dimensions | <p>Note: Indicates the length to the center of the 1.6-dia. holes</p> | <p>1.6-dia. terminal hole</p> | <p>1.65-dia. terminal hole</p> |

■ Dimensions and Operating Characteristics

Thermoplastic Case Models

- Note:**
1. Unless otherwise specified, all units are in millimeters and a tolerance of ± 0.4 mm applies to all dimensions
 2. The following illustrations and drawings are for quick-connect terminals (#250) (terminals C). V models also incorporate terminals A and C2, which are omitted from the following drawings. Refer to *Terminals* section for the dimensions of these terminals.
 3. The □ in the model number is for the terminal code.
 4. The illustrations for V-21, V-16 and V-11 show a hole size of 3.1 mm. V-21, V-16 and V-11 models with a suffix "K" have a hole size of 2.9 mm.
 5. The operating characteristics are for operation in the A direction (↓).

Pin Plunger Models

(Without Barrier)

- V-21-1□6
- V-16-1□5
- V-11-1□4



| Characteristics | V-21-1□6 | V-16-1□5 |
|-----------------|---------------|----------|
| OF max. | 400 gf | 200 gf |
| RF min. | 80 gf | 50 gf |
| PT max. | 1.2 mm | |
| OT min. | 1.0 mm | |
| MD max. | 0.4 mm | |
| OP | 14.7 ± 0.4 mm | |

(With Right-hand Barrier)

- V-21-1□R6
- V-16-1□R5



| Characteristics | V-11-1□4 | V-11-1□5 |
|-----------------|---------------|----------|
| OF max. | 100 gf | 200 gf |
| RF min. | 20 gf | 50 gf |
| PT max. | 1.2 mm | |
| OT min. | 1.0 mm | |
| MD max. | 0.4 mm | |
| OP | 14.7 ± 0.4 mm | |

(With Left-hand Barrier)

- V-21-1□L6
- V-16-1□L5



- Note:** 1. Unless otherwise specified, all units are in millimeters and a tolerance of ± 0.4 mm applies to all dimensions
 2. The following illustrations and drawings are for quick-connect terminals (#250) (terminals C). V models also incorporate terminals A and C2, which are omitted from the following drawings. Refer to *Terminals* section for the dimensions of these terminals.
 3. The □ in the model number is for the terminal code.
 4. The illustrations for V-21, V-16 and V-11 show a hole size of 3.1 mm. V-21, V-16 and V-11 models with a suffix "K" have a hole size of 2.9 mm.
 5. The operating characteristics are for operation in the A direction (↓).

Short Hinge Lever Models

V-211-1□6
 V-161-1□5
 V-111-1□4

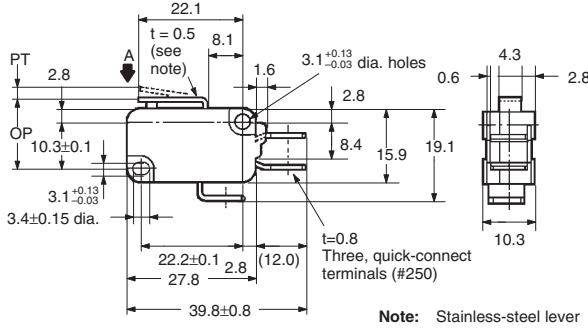

| Characteristics | V-211-1□6 | V-161-1□5 | V-111-1□4 |
|-----------------|---------------|-----------|-----------|
| OF max. | 400 gf | 200 gf | 100 gf |
| RF min. | 50 gf | 50 gf | 15 gf |
| PT max. | 1.6 mm | | |
| OT min. | 0.8 mm | | |
| MD max. | 0.6 mm | | |
| OP | 15.2 ± 0.5 mm | | |

Hinge Lever Models

V-212-1□6
 V-162-1□5
 V-112-1□4



| Characteristics | V-212-1□6 | V-162-1□5 | V-112-1□4 |
|-----------------|---------------|-----------|-----------|
| OF max. | 250 gf | 125 gf | 60 gf |
| RF min. | 25 gf | 14 gf | 6 gf |
| PT max. | 4.0 mm | | |
| OT min. | 1.6 mm | | |
| MD max. | 1.5 mm | | |
| OP | 15.2 ± 1.2 mm | | |

Long Hinge Lever Models

V-213-1□6
 V-163-1□5
 V-113-1□4

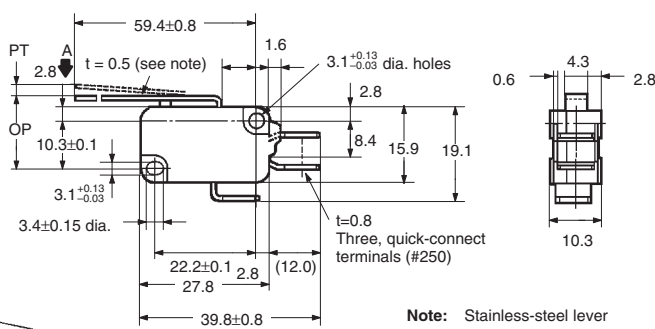

| Characteristics | V-213-1□6 | V-163-1□5 | V-113-1□4 |
|-----------------|---|-----------|---------------|
| OF max. | 130 gf | 70 gf | 35 gf |
| RF min. | 12 gf | 6 gf | --- |
| PT max. | 9.0 mm | | |
| OT min. | 2.0 mm | | 3.2 mm |
| MD max. | 2.8 mm | | |
| OP | 15.2 ^{+2.6} / _{-3.2} mm | | 15.2 ± 2.6 mm |

- Note:**
1. Unless otherwise specified, all units are in millimeters and a tolerance of ± 0.4 mm applies to all dimensions
 2. The following illustrations and drawings are for quick-connect terminals (#250) (terminals C). V models also incorporate terminals A and C2, which are omitted from the following drawings. Refer to *Terminals* section for the dimensions of these terminals.
 3. The □ in the model number is for the terminal code.
 4. The illustrations for V-21, V-16 and V-11 show a hole size of 3.1 mm. V-21, V-16 and V-11 models with a suffix "K" have a hole size of 2.9 mm.
 5. The operating characteristics are for operation in the A direction (↓).

Simulated Roller Lever Models

V-214-1□6
V-164-1□5
V-114-1□4



| Characteristics | V-214-1□6 | V-164-1□5 | V-114-1□4 |
|-----------------|---------------|-----------|-----------|
| OF max. | 250 gf | 125 gf | 60 gf |
| RF min. | 25 gf | 14 gf | 6 gf |
| PT max. | 4.0 mm | | |
| OT min. | 1.6 mm | | |
| MD max. | 1.5 mm | | |
| OP | 18.7 ± 1.2 mm | | |

Short Hinge Roller Lever Models

V-215-1□6
V-165-1□5
V-115-1□4



| Characteristics | V-215-1□6 | V-165-1□5 | V-115-1□4 |
|-----------------|---------------|-----------|-----------|
| OF max. | 480 gf | 240 gf | 120 gf |
| RF min. | 50 gf | 50 gf | 15 gf |
| PT max. | 1.6 mm | | |
| OT min. | 0.8 mm | | |
| MD max. | 0.6 mm | | |
| OP | 20.7 ± 0.6 mm | | |

Hinge Roller Lever Models

V-216-1□6
V-166-1□5
V-116-1□4



| Characteristics | V-216-1□6 | V-166-1□5 | V-116-1□4 |
|-----------------|---------------|-----------|-----------|
| OF max. | 250 gf | 125 gf | 60 gf |
| RF min. | 25 gf | 14 gf | 6 gf |
| PT max. | 4.0 mm | | |
| OT min. | 1.6 mm | | |
| MD max. | 1.5 mm | | |
| OP | 20.7 ± 1.2 mm | | |

Thermosetting Case Models

- Note:** 1. Unless otherwise specified, all units are in millimeters and a tolerance of ± 0.4 mm applies to all dimensions
 2. The following illustrations are for quick-connect terminals (#250) (terminals C). Refer to *Terminals* section for the dimensions of other terminals.
 3. The □ in the model number is for the terminal code.
 4. The illustrations show models with a suffix “K”, which have a hole size of 2.9 mm. Omit the “K” to obtain models with hole size = 3.1 mm.
 5. The operating characteristics are for operation in the A direction (↓).

Pin Plunger Models

V-15G-1□5-K
 V-10G-1□5-K
 V-10G-1□4-K



| Characteristics | V-15G-1□5-K V-10G-1□5-K | V-10G-1□4-K |
|-----------------|----------------------------|-------------|
| OF max. | 200 gf | 100 gf |
| RF min. | 50 gf | 20 gf |
| PT max. | 1.2 mm | |
| OT min. | 1.3 mm | |
| MD max. | 0.3 mm | |
| OP | 14.7 ± 0.4 mm | |

Short Hinge Lever Models

V-15G1-1□5-K
 V-10G1-1□5-K
 V-10G1-1□4-K



Note: Stainless-steel lever

| Characteristics | V-15G1-1□5-K V-10G1-1□5-K | V-10G1-1□4-K |
|-----------------|------------------------------|--------------|
| OF max. | 200 gf | 100 gf |
| RF min. | 50 gf | 15 gf |
| PT max. | 1.5 mm | |
| OT min. | 1.0 mm | |
| MD max. | 0.5 mm | |
| OP | 15.2 ± 0.5 mm | |

Hinge Lever Models

V-15G2-1□5-K
 V-10G2-1□5-K
 V-10G2-1□4-K



Note: Stainless-steel lever

| Characteristics | V-15G2-1□5-K V-10G2-1□5-K | V-10G2-1□4-K |
|-----------------|---|---------------|
| OF max. | 125 gf | 60 gf |
| RF min. | 14 gf | 6 gf |
| PT max. | 3.3 mm | |
| OT min. | 2.3 mm | |
| MD max. | 0.8 mm | |
| OP | 15.2 ^{+2.6} / _{-3.2} mm | 15.2 ± 1.2 mm |

Long Hinge Lever Models

V-15G3-1□5-K
 V-10G3-1□5-K
 V-10G3-1□4-K



Note: Stainless-steel lever

| Characteristics | V-15G3-1□5-K V-10G3-1□5-K | V-10G3-1□4-K |
|-----------------|------------------------------|--------------|
| OF max. | 70 gf | 35 gf |
| RF min. | 6 gf | - - - gf |
| PT max. | 9.0 mm | 7.6 mm |
| OT min. | 3.0 mm | 3.2 mm |
| MD max. | 2.0 mm | |
| OP | 15.2 ± 2.6 mm | |

- Note:** 1. Unless otherwise specified, all units are in millimeters and a tolerance of ± 0.4 mm applies to all dimensions
 2. The following illustrations are for quick-connect terminals (#250) (terminals C). Refer to *Terminals* section for the dimensions of other terminals.
 3. The □ in the model number is for the terminal code.
 4. The illustrations show models with a suffix “K”, which have a hole size of 2.9 mm. Omit the “K” to obtain models with hole size = 3.1 mm.
 5. The operating characteristics are for operation in the A direction (↓).

Simulated Roller Lever Models

V-15G4-1□5-K
 V-10G4-1□5-K
 V-10G4-1□4-K



| Characteristics | V-15G4-1□5-K V-10G4-1□5-K | V-10G4-1□4-K |
|-----------------|------------------------------|--------------|
| OF max. | 125 gf | 60 gf |
| RF min. | 14 gf | 6 gf |
| PT max. | 3.3 mm | |
| OT min. | 2.3 mm | |
| MD max. | 0.8 mm | |
| OP | 18.7 ± 1.2 mm | |

Short Hinge Roller Lever Models

V-15G5-1□5-K
 V-10G5-1□5-K
 V-10G5-1□4-K



| Characteristics | V-15G5-1□5-K V-10G5-1□5-K | V-10G5-1□4-K |
|-----------------|------------------------------|--------------|
| OF max. | 240 gf | 120 gf |
| RF min. | 50 gf | 15 gf |
| PT max. | 1.5 mm | |
| OT min. | 1.0 mm | |
| MD max. | 0.5 mm | |
| OP | 20.7 ± 0.6 mm | |

Hinge Roller Lever Models

V-15G6-1□5-K
 V-10G6-1□5-K
 V-10G6-1□4-K



| Characteristics | V-15G6-1□5-K V-10G6-1□5-K | V-10G6-1□4-K |
|-----------------|------------------------------|--------------|
| OF max. | 125 gf | 60 gf |
| RF min. | 14 gf | 6 gf |
| PT max. | 3.3 mm | |
| OT min. | 2.3 mm | |
| MD max. | 0.8 mm | |
| OP | 20.7 ± 1.6 mm | |

Accessories

Refer to the “V/VX/D3C Common Accessories” datasheet for information regarding VAL, VAM and VAV external actuators (sold separately).

Precautions

Be sure to read the precautions and information common to all Snap Action and Detection Switches, contained in the Technical User's Guide, "Snap Action Switches, Technical Information" for correct use.

■ Correct Use

Terminal Connection

To solder the lead to the solder terminal, apply a soldering iron rated at 60 W max. quickly (within 5 seconds) with the actuator at the free position.

Note that applying a soldering iron for too long a time or using one that is rated at more than 60 W may degrade the switch characteristics.

Use an appropriate mating connector for #187 or #250 quick connect terminals.

Specifications Approved by TÜV Rheinland According to EN61058-1

Appropriate Cable Size (mm²)

| Model | Solder terminal |
|-------|-----------------|
| V-10 | 0.75, 1.25, 2.0 |
| V-15 | 1.25, 2.0 |

Operation

Make sure that the operating body pushes the switch actuator with an adequate force when the switch is to be operated, and that it does not touch the actuator when the switch is released.

Do not change the operating position by modifying the actuator.

Do not use the switch in a application where the operating speed is extremely slow or the actuator is set in the midpoint between the free position and operating position.

Install the pin plunger switch so that the operating force is applied in alignment with the stroke of the actuator. The switch should be set so that its stroke is in the range of 60 to 90% of the rated OT (minimum value) when the switch has been operated.

■ Cautions

Insulation Distance

According to EN61058-1, the minimum insulation thickness for this switch should be 1.1 mm and minimum clearance distance between the terminal and mounting plate should be 1.0 mm. If the insulation distance cannot be provided in the product incorporating the switch, either use a switch with insulation barrier or use a separator to ensure sufficient insulation distance.

A large grid of 20 columns and 30 rows of small squares, intended for taking notes. The grid is composed of thin, light gray lines forming a uniform pattern of small squares across the page.

All sales are subject to Omron Electronic Components LLC standard terms and conditions of sale, which can be found at http://www.components.omron.com/components/web/webfiles.nsf/sales_terms.html

ALL DIMENSIONS SHOWN ARE IN MILLIMETERS.
To convert millimeters into inches, multiply by 0.03937. To convert grams into ounces, multiply by 0.03527.

OMRON[®]

**OMRON ELECTRONIC
COMPONENTS LLC**

55 E. Commerce Drive, Suite B
Schaumburg, IL 60173

847-882-2288

OMRON ON-LINE

Global - <http://www.omron.com>

USA - <http://www.components.omron.com>



Компания «ЭлектроПласт» предлагает заключение долгосрочных отношений при поставках импортных электронных компонентов на взаимовыгодных условиях!

Наши преимущества:

- Оперативные поставки широкого спектра электронных компонентов отечественного и импортного производства напрямую от производителей и с крупнейших мировых складов;
- Поставка более 17-ти миллионов наименований электронных компонентов;
- Поставка сложных, дефицитных, либо снятых с производства позиций;
- Оперативные сроки поставки под заказ (от 5 рабочих дней);
- Экспресс доставка в любую точку России;
- Техническая поддержка проекта, помощь в подборе аналогов, поставка прототипов;
- Система менеджмента качества сертифицирована по Международному стандарту ISO 9001;
- Лицензия ФСБ на осуществление работ с использованием сведений, составляющих государственную тайну;
- Поставка специализированных компонентов (Xilinx, Altera, Analog Devices, Intersil, Interpoint, Microsemi, Aeroflex, Peregrine, Syfer, Eurofarad, Texas Instrument, Miteq, Cobham, E2V, MA-COM, Hittite, Mini-Circuits, General Dynamics и др.);

Помимо этого, одним из направлений компании «ЭлектроПласт» является направление «Источники питания». Мы предлагаем Вам помощь Конструкторского отдела:

- Подбор оптимального решения, техническое обоснование при выборе компонента;
- Подбор аналогов;
- Консультации по применению компонента;
- Поставка образцов и прототипов;
- Техническая поддержка проекта;
- Защита от снятия компонента с производства.



Как с нами связаться

Телефон: 8 (812) 309 58 32 (многоканальный)

Факс: 8 (812) 320-02-42

Электронная почта: org@eplast1.ru

Адрес: 198099, г. Санкт-Петербург, ул. Калинина, дом 2, корпус 4, литера А.