

## 1A Step-down DC/DC Converters with synchronous rectifier

NO.EA-199-111124

### OUTLINE

The RP501K Series are CMOS-based step-down DC/DC Converters with synchronous rectifier.

Each of these ICs consists of an oscillator, a switching control circuit, a reference voltage unit, an error amplifier, a soft-start circuit, protection circuits, UVLO circuit, switching transistors. A low ripple, high efficiency step-down DC/DC converter can be easily composed of this IC with only an inductor and capacitors. In terms of the output voltage, since the feedback resistances are built-in, the voltage is fixed internally. 50mV (custom-made) step output can be set by laser-trim and  $\pm 1.5\%$  or  $\pm 24\text{mV}$  tolerance depending on the output voltage is guaranteed.

Mode alternative circuit works automatically for improving the efficiency. Considering fixed noise frequency, PWM fixed control type is also available. As protection circuits, the current limit circuit which limits peak current of  $L_x$  at each clock cycle, and the latch type protection circuit which works if the term of the over-current condition keeps on a certain time exist. The latch-type protection circuit works to latch an internal driver with keeping it disable. To release the condition of the protection, after disabling this IC with a chip enable circuit, enable it again, or restart this IC with power-on or make the supply voltage at UVLO detector threshold level or lower than UVLO.

Since the package is DFN(PLP)2527-10, high density mounting on boards is possible.

### FEATURES

- Input Voltage Range .....2.5V to 5.5V
- Output Voltage .....1.0V to 3.3V
- High Accuracy Output Voltage ..... $\pm 1.5\%$  ( $V_{OUT} \geq 1.6\text{V}$ )  
..... $\pm 24\text{mV}$  ( $V_{OUT} < 1.6\text{V}$ )
- Oscillator Frequency .....Typ. 2.25MHz
- Built-in Soft start Function .....Max.0.2ms
- Built-in Peak current limit .....Typ.1.5A
- Built-in UVLO Function .....Typ. 2.2V
- Switching Mode can be controlled by Mode pin ....Automatic PWM/VFM mode change / PWM fixed
- Package .....DFN(PLP)2527-10

### APPLICATIONS

- Power source for portable equipment such as cellular, PDA, DSC, Notebook PC
- Power source for HDD, WLA N, Car accessories
- Power source for Li-ion battery-used equipment

**BLOCK DIAGRAM**

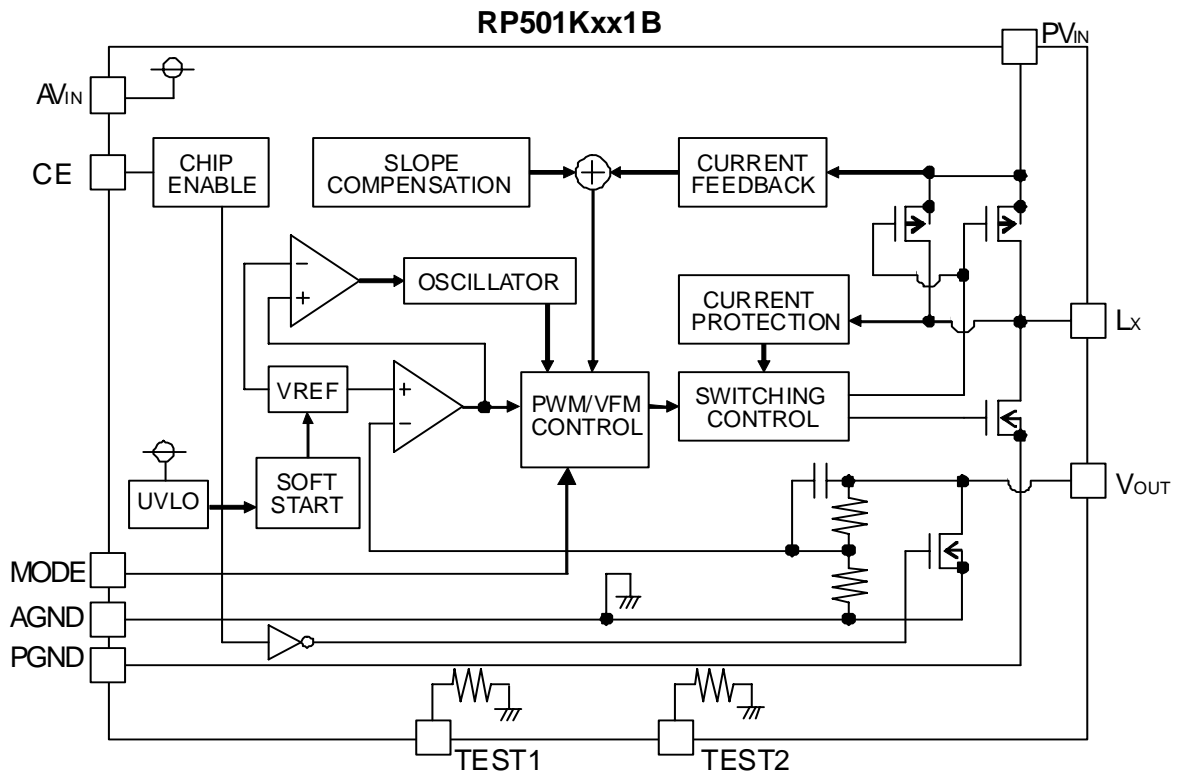
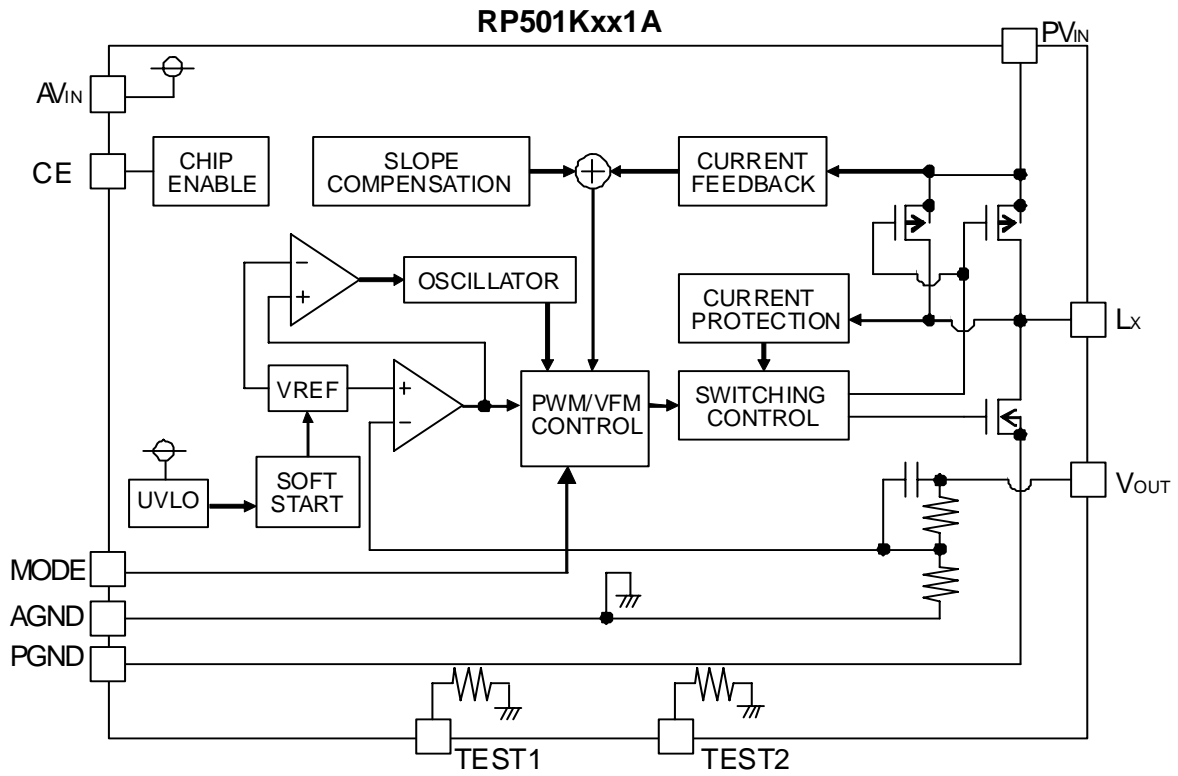

Mode="H": PWM/VFM alternative , Mode="L": PWM fix control  
 Test Pin must be connected to GND.

## Selection Guide

In the RP501K series, output voltage and version can be designated with user's request.  
Part number can be designated as follows:

Product Name	Package	Quantity per Reel	Pb Free	Halogen Free
RP501Kxx1*-TR	DFN(PLP)2527-10	5,000 pcs	Yes	Yes
xx : Designation of output voltage( $V_{OUT}$ ): Designation is possible in the range from 1.0V to 3.3V with a step of 0.1V				
* : Designation of Active Type (A) without auto-discharge function (B) with auto-discharge function				

When the mode is into standby with CE signal, auto-discharge transistor turns on, and it makes the turn-off speed faster than normal type.

\* Stepwise setting with 0.05V is possible by custom-made.

## PIN CONFIGURATION

DFN(PLP)2527-10

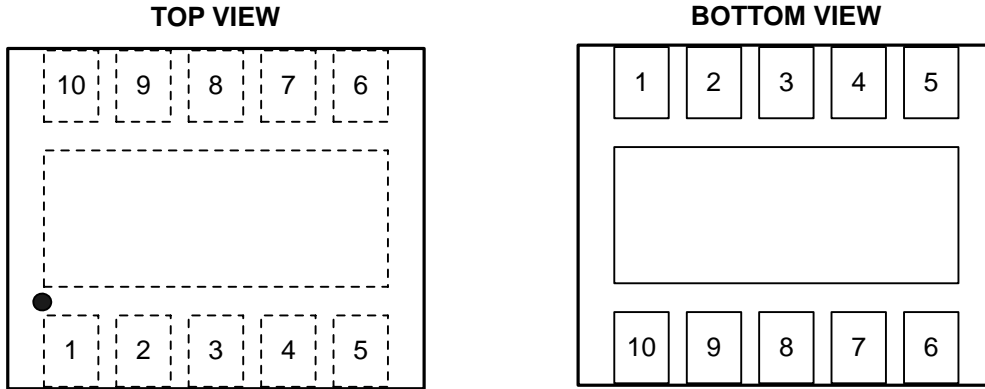

## PIN DESCRIPTIONS

Pin No.	Symbol	Pin Description
1	CE	Chip Enable Pin ("H" Active)
2	TEST1	Test Pin 1 (Connect this pin to the GND)
3	AGND	Ground Pin
4	PGND	Ground Pin
5	L <sub>x</sub>	Switch Output Pin
6	PV <sub>IN</sub>	Input Pin
7	TEST2	Test Pin 2 (Connect this pin to the GND)
8	MODE	Mode Control Pin
9	AV <sub>IN</sub>	Input Pin
10	V <sub>OUT</sub>	Output Pin

\* Tab is GND level. (They are connected to the reverse side of this IC.) The tab is better to be connected to the GND, but leaving it open is also acceptable.

\* All V<sub>IN</sub> terminals must be connected.

\* All GND terminals must be connected.

## ABSOLUTE MAXIMUM RATINGS

(AGND=PGND=0V)

Symbol	Item	Rating	Unit
$V_{IN}$	$V_{IN}$ Supply Voltage	-0.3 to 6.5	V
$PV_{IN}$	$PV_{IN}$ Supply Voltage	-0.3 to 6.5	V
$V_{LX}$	Lx Pin Voltage	-0.3 to A/ $PV_{IN}+0.3$	V
$V_{CE}$	CE Pin Input Voltage	-0.3 to 6.5	V
$V_{MODE}$	MODE Pin Input Voltage	-0.3 to 6.5	V
$V_{OUT}$	$V_{OUT}$ Pin Voltage	-0.3 to 6.5	V
$I_{LX}$	Lx Pin Output Current	1.5	A
$P_D$	Power Dissipation *	910	mW
$T_a$	Operating Temp. Range	-40 to 85	°C
$T_{stg}$	Storage Temp. Range	-55 to 125	°C

\*) For Power Dissipation, please refer to PACKAGE INFORMATION.

### ABSOLUTE MAXIMUM RATINGS

Electronic and mechanical stress momentarily exceeded absolute maximum ratings may cause the permanent damages and may degrade the life time and safety for both device and system using the device in the field. The functional operation at or over these absolute maximum ratings is not assured.

### RECOMMENDED OPERATING CONDITIONS (ELECTRICAL CHARACTERISTICS)

All of electronic equipment should be designed that the mounted semiconductor devices operate within the recommended operating conditions. The semiconductor devices cannot operate normally over the recommended operating conditions, even if when they are used over such conditions by momentary electronic noise or surge. And the semiconductor devices may receive serious damage when they continue to operate over the recommended operating conditions.

## ELECTRICAL CHARACTERISTICS

RP501Kxx1x

Ta=25°C

Symbol	Item	Condition	Min.	Typ.	Max.	Unit
A/PVIN	Operating Input Voltage		2.5		5.5	V
VOUT	Step-down Output Voltage	A/PVIN=VCE=3.6V, VMODE=0V VOUT≥1.6V VOUT<1.6V	-1.5% -0.024		+1.5% 0.024	V
$\Delta V_{OUT}/\Delta T_a$	Step-down Output Voltage Temperature Coefficient	-40°C≤Ta≤85°C		±100		ppm/°C
fosc	Oscillator Frequency	A/PVIN=VCE=3.6V	2.025	2.25	2.475	MHz
IDD1	Supply Current 1	A/PVIN=VCE=5.5V, VOUT=0		450	650	μA
IDD2	Supply Current 2	A/PVIN=VCE=VOUT=5.5V		140	210	μA
Istandby	Standby Current	A/PVIN=5.5V, VCE=0V		0	5	μA
ILxleak	Lx Leakage Current	A/PVIN=5.5V, VLX=A/PVIN/GND, VCE=0V	-5	0	5	μA
RONP	On Resistance of Pch Tr.	A/PVIN=5.0V, ILX=-100mA		0.25	0.35	Ω
RONN	On Resistance of Nch Tr.	A/PVIN=5.0V, ILX=-100mA		0.25	0.35	Ω
Maxduty	Max Duty Ratio		100			%
tstart	Soft-start Time	A/PVIN=VCE=3.6V		0.14	0.2	ms
tprot	Protection Delay Time	A/PVIN=VCE=3.6V	0.5	2.0	6.0	ms
ILxlim	Lx Current Limit	A/PVIN=VCE=3.6V	1.2	1.5		A
VUVLO1	UVLO Detector Voltage	A/PVIN=VCE	2.1	2.2	2.3	V
VUVLO2	UVLO Released Voltage	A/PVIN=VCE	2.2	VUVLO1 +0.1	2.4	V
ICE	CE Input Current	A/PVIN=5.5V, VCE=5.5V/0V	-0.1	0.0	0.1	μA
IVOUT	VOUT Input Current	A/PVIN=5.5V, VCE=0V *1	-0.1	0.0	0.1	μA
RLOW	Nch On Resistance for Auto Discharge	A/PVIN=5.5V, VCE=0V *2		150		Ω
VCEH	CE "H" Input Voltage	A/PVIN=5.5V	1.0			V
VCEL	CE "L" Input Voltage	A/PVIN=3.0V			0.4	V
IMODE	Mode Input Current	A/PVIN= 5.5V, VMODE=5.5V/0V	-0.1	0.0	0.1	μA
VMODEH	Mode "H" Input Voltage	A/PVIN=VCE=5.5V	1.0			V
VMODEL	Mode "L" Input Voltage	A/PVIN=VCE=3.0V			0.4	V

Test circuit is "OPEN LOOP" and A/PVIN=VCE=3.6V, AGND=PGND=0V unless otherwise noted.

\*1) without auto-discharge type

\*2) with auto-discharge type

TEST CIRCUITS

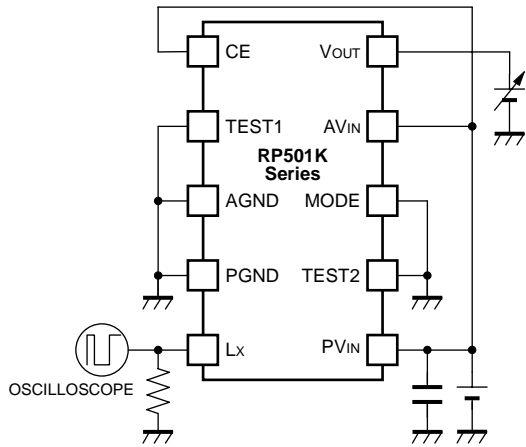

Output Voltage

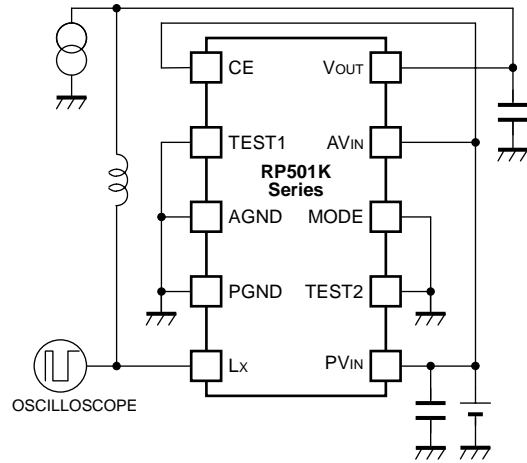

Oscillator Frequency

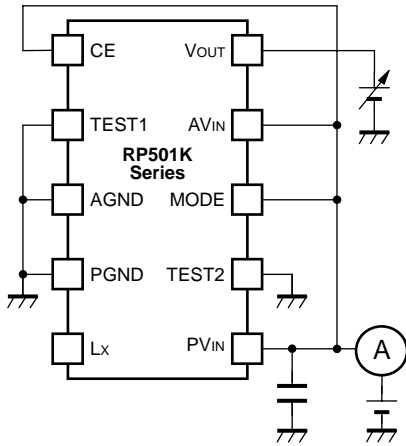

Supply Current 1 / 2

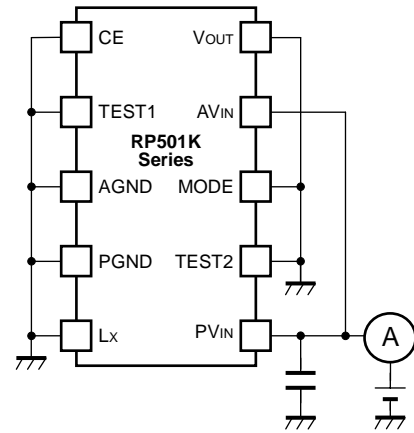

Standby Current

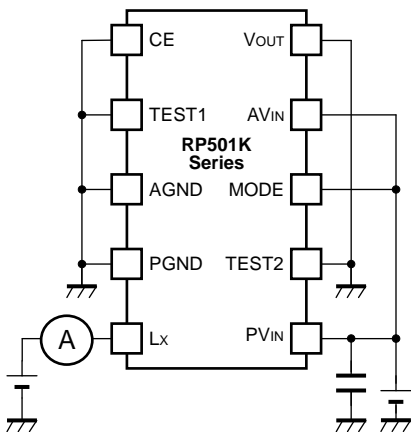

Lx Leakage Current

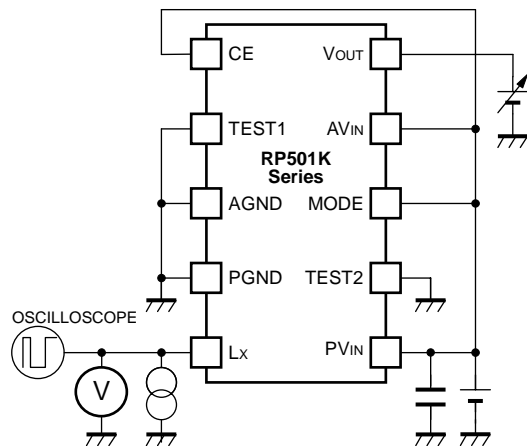

Pch·Nch ON Resistance /  
Protection Delay Time / Lx Current Limit

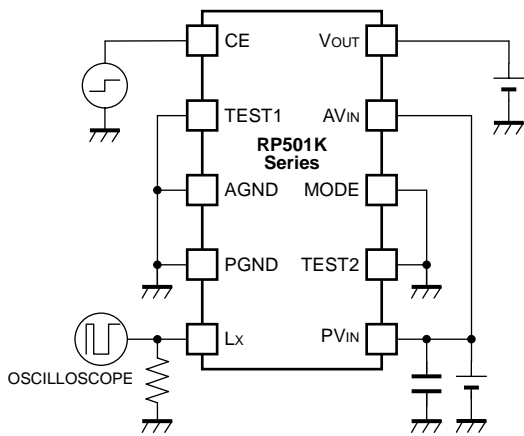

Soft-start Time

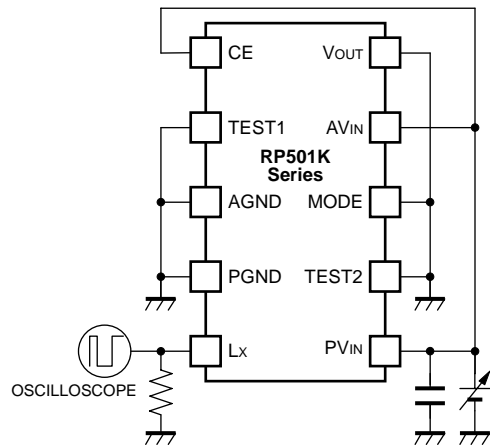

UVLO Detector Voltage / Released Voltage

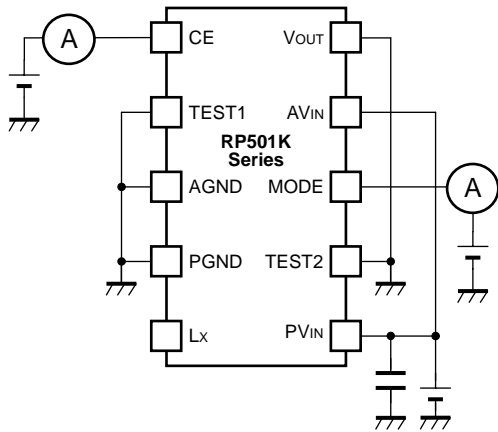

CE-MODE Input Current "H"/"L"

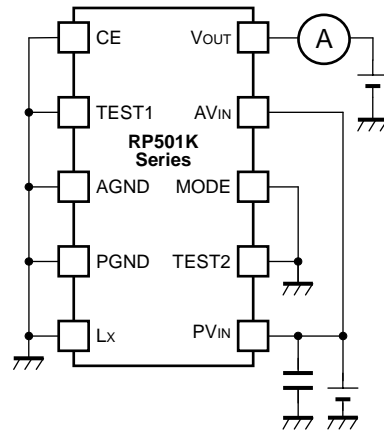

V<sub>out</sub> Input Current /  
Nch On Resistance for Auto Discharge

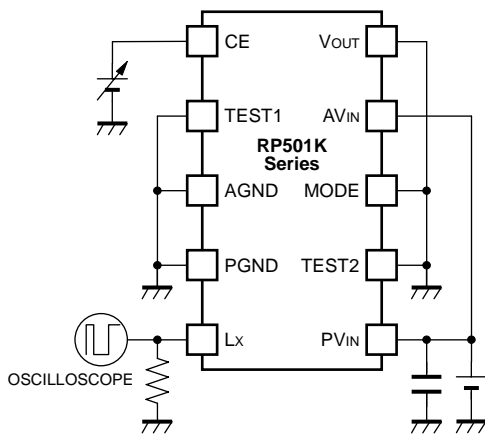

CE Input Voltage

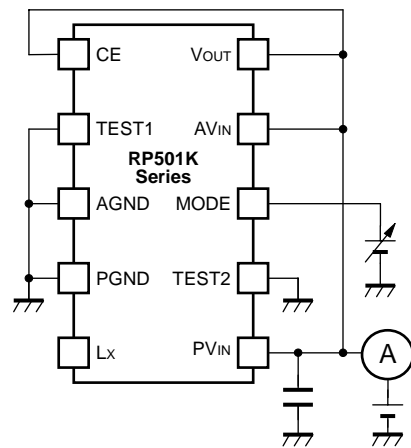

MODE Input Voltage



## TYPICAL APPLICATION

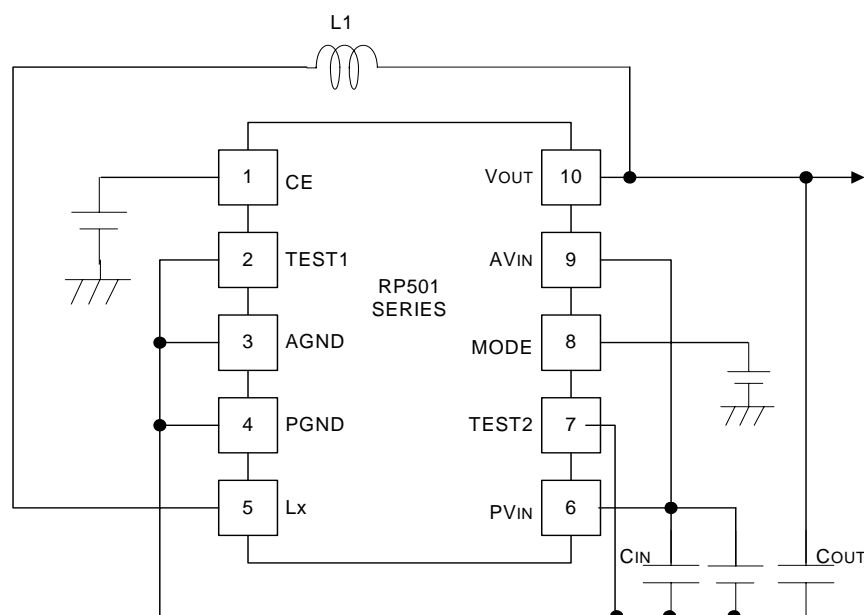

### Parts Recommendation

$C_{IN}$ : 10 $\mu$ F Ceramic (C1608JB0J106K , TDK)

$C_{OUT}$ : 4.7 $\mu$ F Ceramic (C1608JB1A475K , TDK)

L: 2.2 $\mu$ H (NR3010T2R2M , Taiyo Yuden)

## TECHNICAL NOTES

When you use these ICs, consider the following issues:

- Set the same level as AGND and PGND.
- Set external components such as an inductor,  $C_{IN}$ ,  $C_{OUT}$  as close as possible to the IC, in particular, minimize the wiring to  $V_{IN}$  pin and PGND pin. The wiring between  $V_{OUT}$  and load and between L and  $V_{OUT}$  should be separated.
- Use an external capacitor  $C_{IN}$  between  $V_{IN}$  and GND, and  $C_{OUT}$  with a capacity of 4.7 $\mu$ F or more ceramic type.
- Choose an inductor with appropriate inductance range. The phase compensation has been made by these values with output capacitors. The recommendation characteristics of the inductor are low DC resistance, large enough permissible current, and strong against the magnetic saturation. Inductance value may shift depending on an inductor. If the inductance value at an actual load current is low,  $L_x$  peak current may increase and may overlap the  $L_x$  current limit. As a result, over current protection may work.
- Over current protection circuit may be affected by self-heating and heat radiation environment.
- Reinforce the  $V_{IN}$ , PGND, and  $V_{OUT}$  lines sufficiently. Large switching current may flow in these lines. If the impedance of  $V_{IN}$  and PGND lines is too large, the internal voltage level in this IC may shift caused by the switching current, and the operation might be unstable.

The performance of power source circuits using these ICs extremely depends upon the peripheral circuits. Pay attention in the selection of the peripheral circuits. In particular, design the peripheral circuits in a way that the values such as voltage, current, and power of each component, PCB patterns and the IC do not exceed their respected rated values.( such as the voltage, current, and power)

## Operation of step-down DC/DC converter and Output Current

The DC/DC converter charges energy in the inductor when Lx transistor is ON, and discharges the energy from the inductor when Lx transistor is OFF and controls with less energy loss, so that a lower output voltage than the input voltage is obtained. The operation will be explained with reference to the following diagrams:

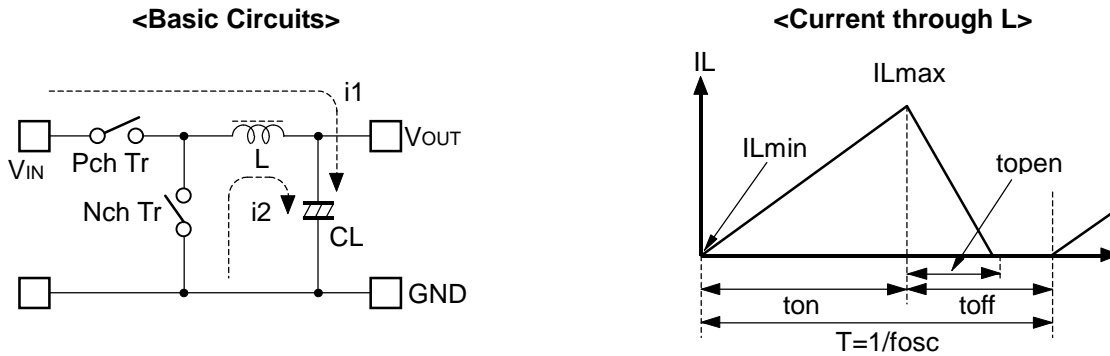

- Step 1: P-channel Tr. turns on and current IL (=i1) flows, and energy is charged into CL. At this moment, IL increases from ILmin (=0) to reach ILmax in proportion to the on-time period (ton) of P-channel Tr.
- Step 2: When P-channel Tr. turns off, Synchronous rectifier N-channel Tr. turns on in order that L maintains IL at ILmax, and current IL (=i2) flows.
- Step 3: IL (=i2) decreases gradually and reaches IL=ILmin=0 after a time period of topen, and N-channel Tr. Turns off. Provided that in the continuous mode, next cycle starts before IL becomes to 0 because toff time is not enough. In this case, IL value increases from this ILmin (>0).

In the case of PWM control system, the output voltage is maintained by controlling the on-time period (ton), with the oscillator frequency (fosc) being maintained constant.

The maximum value (ILmax) and the minimum value (ILmin) of the current flowing through the inductor are the same as those when P-channel Tr. turns on and off.

The difference between ILmax and ILmin, which is represented by ΔI:

$$\Delta I = I_{Lmax} - I_{Lmin} = V_{OUT} \times t_{open} / L = (V_{IN} - V_{OUT}) \times t_{on} / L \dots\dots\dots \text{Equation 1}$$

wherein,

$$T = 1 / f_{osc} = t_{on} + t_{off}$$

$$\text{duty (\%)} = t_{on} / T \times 100 = t_{on} \times f_{osc} \times 100$$

$$t_{open} \leq t_{off}$$

In Equation 1, VOUT x topen/L and (VIN - VOUT) x ton/L respectively show the change of the current at "ON", and the change of the current at "OFF".

## Discontinuous mode and Continuous mode

When the output current ( $I_{OUT}$ ) is relatively small,  $t_{open} < t_{off}$  as illustrated in the following diagram. In this case, the energy is charged in the inductor during the time period of  $t_{on}$  and is discharged in its entirety during the time period of  $t_{off}$ , therefore  $I_{Lmin}$  becomes to zero ( $I_{Lmin}=0$ ). When  $I_{OUT}$  is gradually increased, eventually,  $t_{open}$  becomes to  $t_{off}$  ( $t_{open}=t_{off}$ ), and when  $I_{OUT}$  is further increased,  $I_{Lmin}$  becomes larger than zero ( $I_{Lmin}>0$ ). The former mode is referred to as the discontinuous mode and the latter mode is referred to as continuous mode.

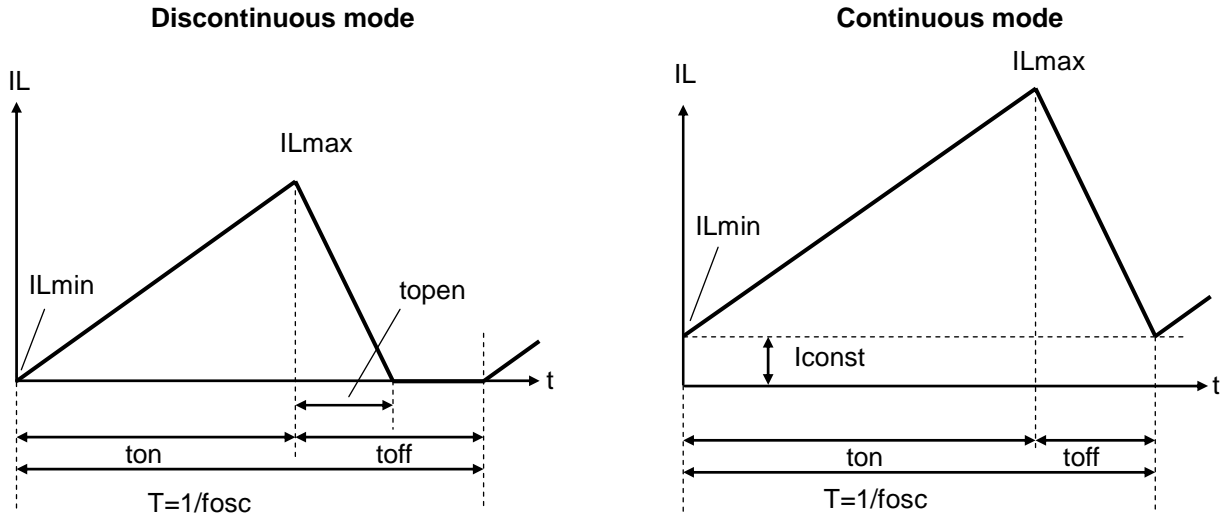

In the continuous mode, when Equation 1 is solved for  $t_{on}$  and assumed that the solution is  $t_{onc}$ ,

$$t_{onc} = T \times V_{OUT} / V_{IN} \dots\dots\dots \text{Equation 2}$$

When  $t_{on} < t_{onc}$ , the mode is the discontinuous mode, and when  $t_{on} = t_{onc}$ , the mode is the continuous mode.

## Output Current and selection of External components

The relation between the output current and external components is as follows:

When P-channel Tr. of L<sub>x</sub> is ON:

(Wherein, Ripple Current P-P value is described as I<sub>RP</sub>, ON resistance of P-channel Tr. and N-channel Tr. of L<sub>x</sub> are respectively described as R<sub>ONP</sub> and R<sub>ONN</sub>, and the DC resistor of the inductor is described as R<sub>L</sub>.)

$$V_{IN} = V_{OUT} + (R_{ONP} + R_L) \times I_{OUT} + L \times I_{RP} / t_{on} \dots \dots \dots \text{Equation 3}$$

When P-channel Tr. of L<sub>x</sub> is "OFF"(N-channel Tr. is "ON"):

$$L \times I_{RP} / t_{off} = R_{ONN} \times I_{OUT} + V_{OUT} + R_L \times I_{OUT} \dots \dots \dots \text{Equation 4}$$

Put Equation 4 to Equation 3 and solve for ON duty of P-channel transistor,  $t_{on}/(t_{off} + t_{on}) = D_{ON}$ ,

$$D_{ON} = (V_{OUT} + R_{ONN} \times I_{OUT} + R_L \times I_{OUT}) / (V_{IN} + R_{ONN} \times I_{OUT} - R_{ONP} \times I_{OUT}) \dots \dots \dots \text{Equation 5}$$

Ripple Current is as follows:

$$I_{RP} = (V_{IN} - V_{OUT} - R_{ONP} \times I_{OUT} - R_L \times I_{OUT}) \times D_{ON} / f_{osc} / L \dots \dots \dots \text{Equation 6}$$

wherein, peak current that flows through L, and L<sub>x</sub> Tr. is as follows:

$$I_{Lmax} = I_{OUT} + I_{RP} / 2 \dots \dots \dots \text{Equation 7}$$

\*Consider I<sub>Lmax</sub>, condition of input and output and select external components.

\*The above explanation is directed to the calculation in an ideal case in continuous mode.

## TIMING CHART

### (1) Soft Start Time

#### In the case of starting this IC with CE

In the case of starting this IC with CE, the operation can be as in the timing chart below.

When the voltage of CE pin ( $V_{CE}$ ) is beyond the threshold level, the operation of the IC starts. The threshold voltage of CE pin is in between CE "H" input voltage ( $V_{CEH}$ ) and CE "L" input voltage ( $V_{CEL}$ ) described in the electrical characteristics table. Soft-start circuit operates, and after the certain time, the reference voltage inside the IC ( $V_{REF}$ ) is rising gradually up to the constant value.

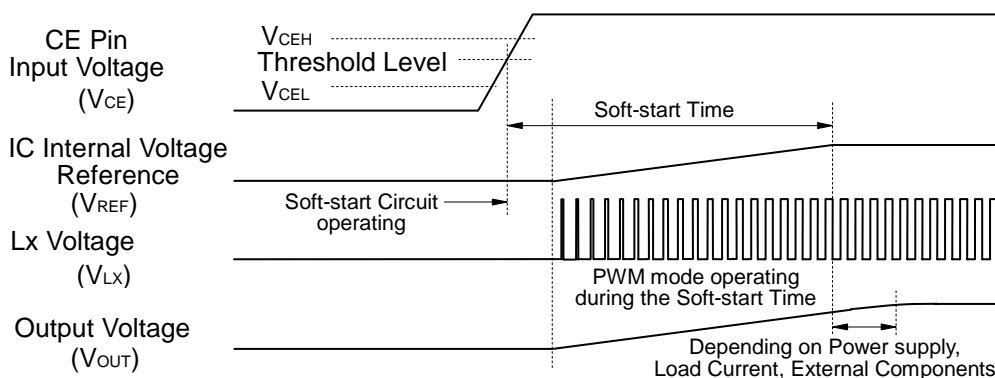

Soft-start time is the time interval from soft start circuit starting point to the reference voltage level reaching point up to this constant level.

\*Soft start time is not always equal to the turn-on speed of DC/DC converter.

The power supply capacity for this IC, load current, inductance and capacitance values affect the turn-on speed.

#### In the case of starting with power supply

In the case of starting with power supply, when the input voltage ( $V_{IN}$ ) is larger than UVLO released voltage ( $V_{UVLO2}$ ), soft start circuit operates, and after that, the same explanation above is applied to the operation.

Soft-start time is the time interval from soft start circuit starting point to the reference voltage level reaching point up to this constant level.

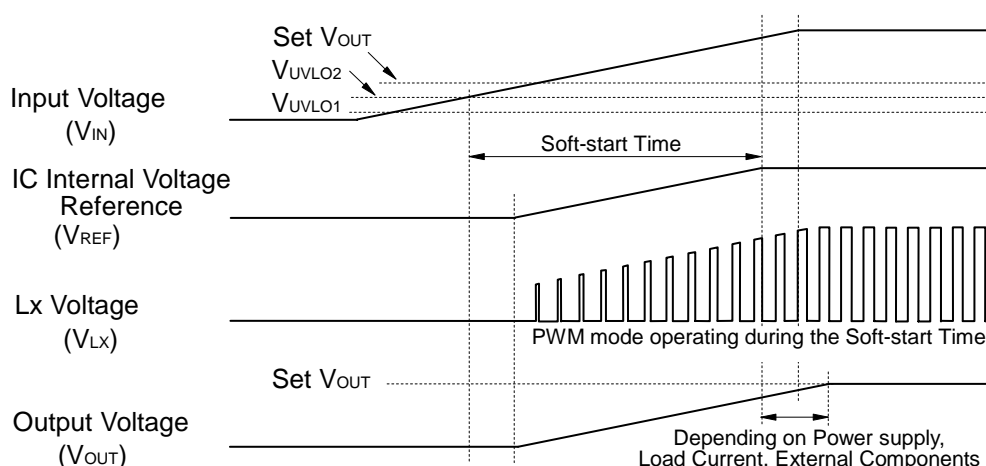

\*Turn-on speed is affected by next conditions;

- (a) Input Voltage ( $V_{IN}$ ) rising speed depending on the power supplier to the IC and input capacitor  $C_{IN}$ .
- (b) Output Capacitor  $C_{OUT}$  value and load current value.

**(2) Under Voltage Lockout (UVLO) Circuit**

The step-down DC/DC converter stops and ON duty becomes 100%, if input voltage ( $V_{IN}$ ) becomes less than the set output voltage (Set  $V_{OUT}$ ), the output voltage ( $V_{OUT}$ ) gradually drops according to the input voltage ( $V_{IN}$ ).

If the input voltage drops more and becomes less than UVLO detector threshold ( $V_{UVLO1}$ ), the under voltage lockout circuit (UVLO) operates, the IC internal reference voltage ( $V_{REF}$ ) stops, switching transistors turn off and the output voltage drops according to the load and output capacitor  $C_{OUT}$  value.

To restart the normal operation, the input voltage ( $V_{IN}$ ) must be more than the UVLO released voltage ( $V_{UVLO2}$ ). The timing chart below describes the operation with varying the input voltage ( $V_{IN}$ ).

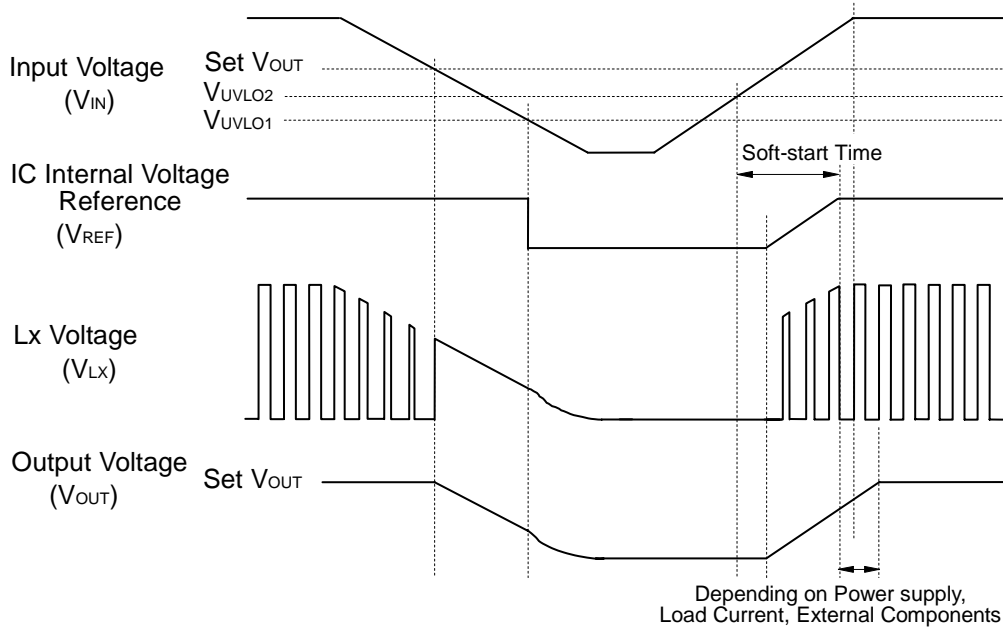

\*Actually, the waveform of  $V_{OUT}$  at UVLO working and releasing varies depending on the initial voltage of  $C_{OUT}$  and load current situation.

### (3) Over Current Protection Circuit, Latch Type Protection Circuit

Over current protection circuit supervises the coil peak current (the current flowing Pch transistor) at each switching cycle, and if the current beyond the L<sub>x</sub> current limit (I<sub>Lxlim</sub>), Pch transistor is turned off. The L<sub>x</sub> current limit of RP501K is Typ.1.5A.

Further, if the over current status continues equal or longer than protection delay time, or, when the L<sub>x</sub> limit current is exceeded even once when the driver operates by duty 100%, a built-in driver is latched in the OFF state and the operation of DC/DC converter stops.

\*L<sub>x</sub> current limit and protection delay time is affected by self-heating and ambient environment. If the output is short and the input voltage (V<sub>IN</sub>) is drastically dropped or becomes unstable, the protection operation and delay time may vary.

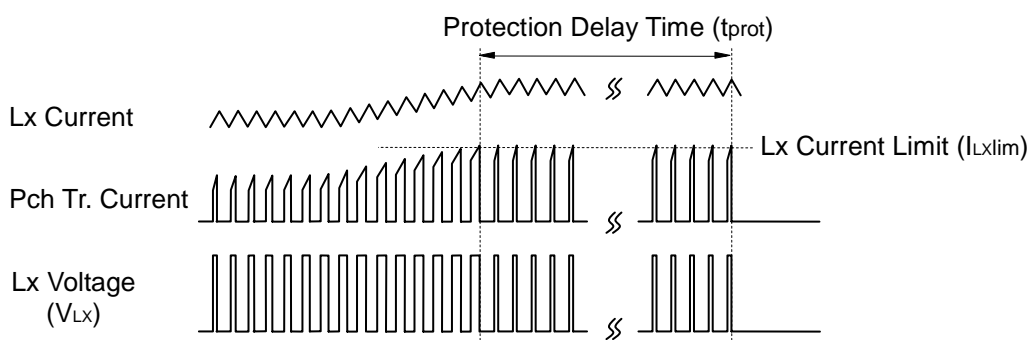

To release the condition of latch type protection, restart this IC by inputting "L" signal to CE pin, or restart this IC with power-on or make the supply voltage lower than UVLO detector threshold (V<sub>UVLO1</sub>) level.

The timing chart shown below describes the changing process of input voltage rising, stable operating, operating with large current, reset with CE pin, stable operating, input voltage falling, input voltage recovering, and stable operating.

If too large current flows through the circuit because of short or other reasons, after the delay time of latch type protection a built-in driver is latched in the OFF state and V<sub>Lx</sub> signal will be "L", then output will turn off.

At the point (1), release the latch type protection is realized with CE reset as changed CE signal from "L" to "H".

At the point (2), release the latch type protection is realized with UVLO reset as make the supply voltage lower than UVLO detector threshold (V<sub>UVLO1</sub>) level.

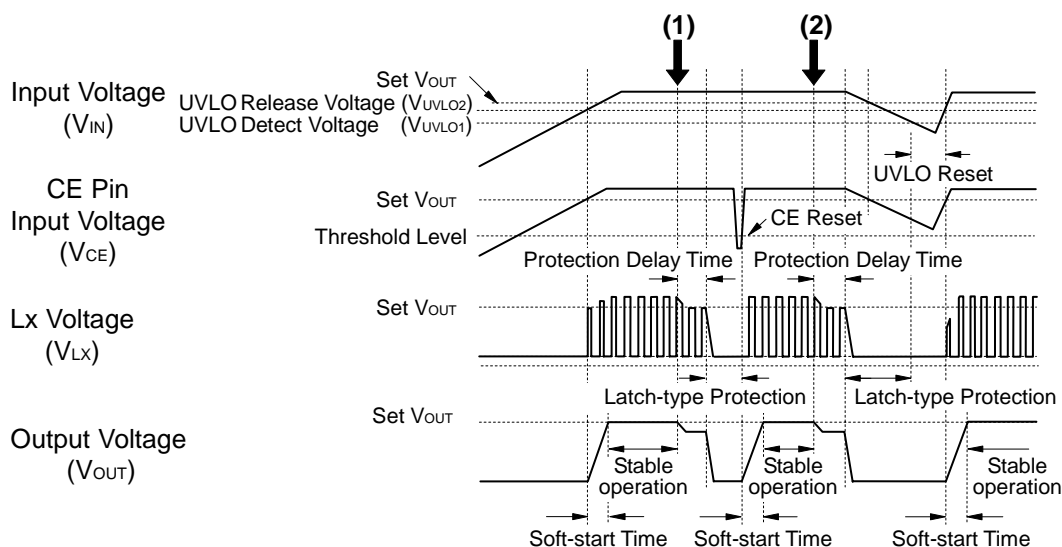

TYPICAL CHARACTERISTICS

1) Efficiency vs. Output Current  
1-1 Input Voltage Dependence

RP501K121x(PWM fixed)  
MODE=0V

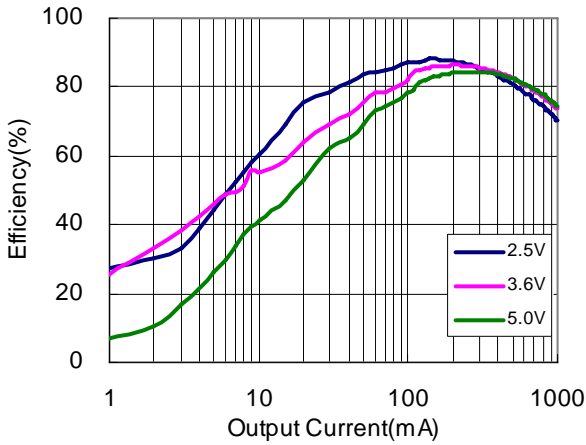

RP501K121x(PWM/VFM mode change)  
MODE=VIN

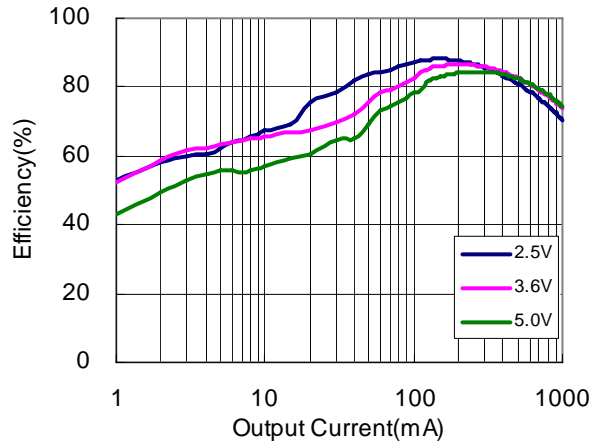

RP501K151x(PWM fixed)  
MODE=0V

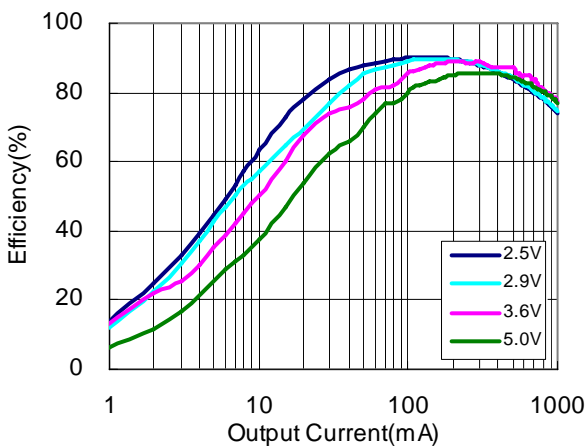

RP501K151x(PWM/VFM mode change)  
MODE=VIN

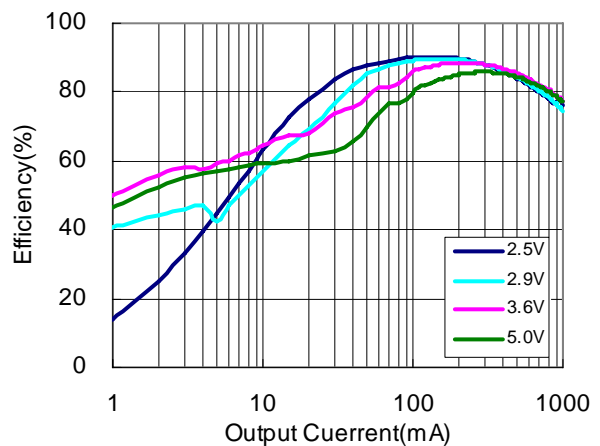

RP501K181x(PWM fixed)  
MODE=0V

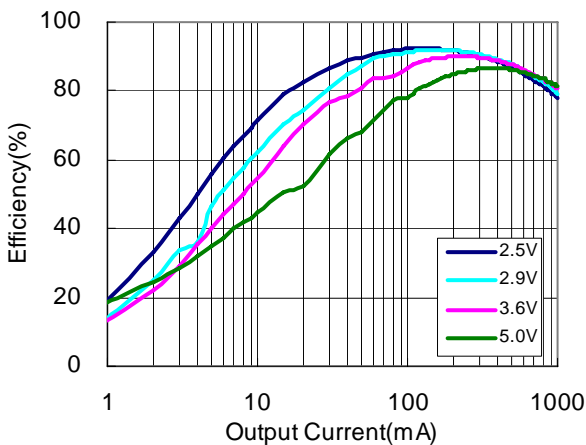

RP501K181x(PWM/VFM mode change)  
MODE=VIN

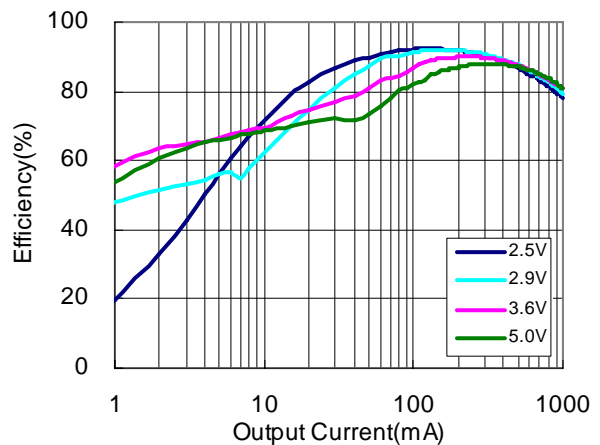



**RP501K331x(PWM fixed)**  
MODE=0V

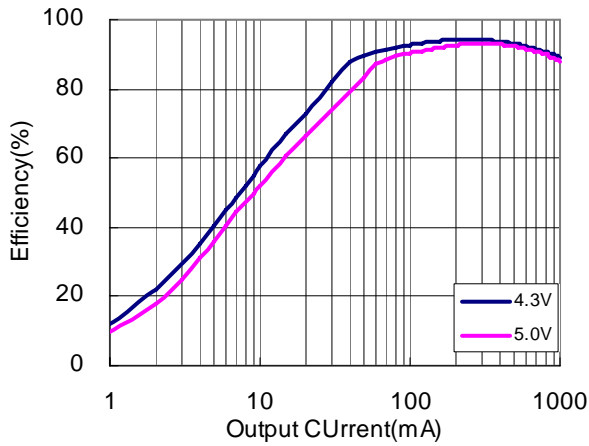

**RP501K331x(PWM/VFM mode change)**  
MODE=VIN

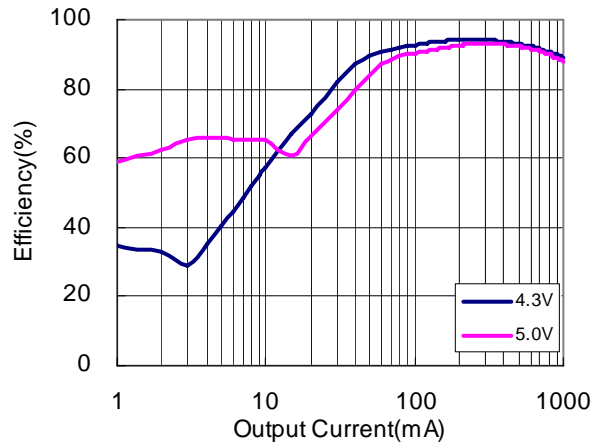

1-2 Temperature Dependence

**RP501K121x(PWM fixed)**  
VIN=3.6V,MODE=0V

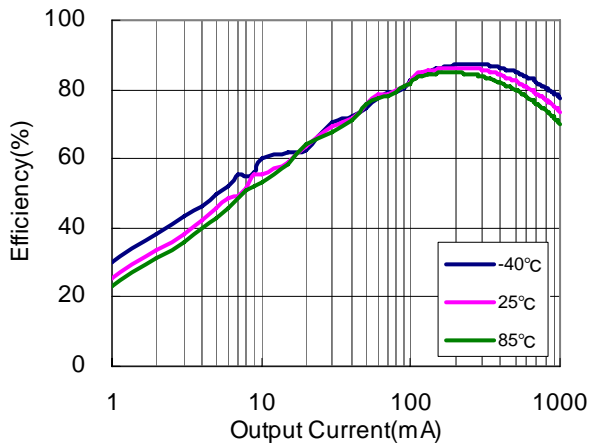

**RP501K121x(PWM/VFM mode change)**  
VIN=MODE=3.6V

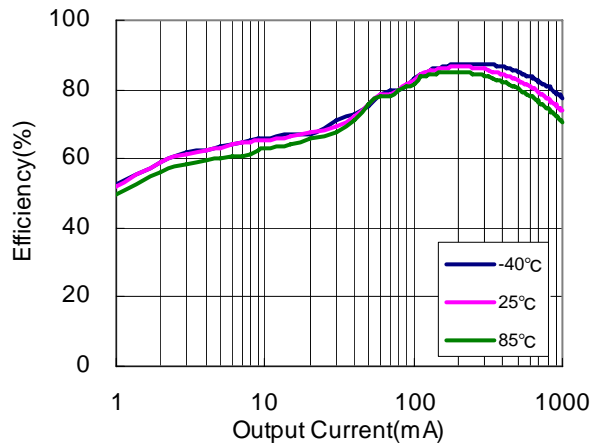

**RP501K151x(PWM fixed)**  
VIN=3.6V,MODE=0V

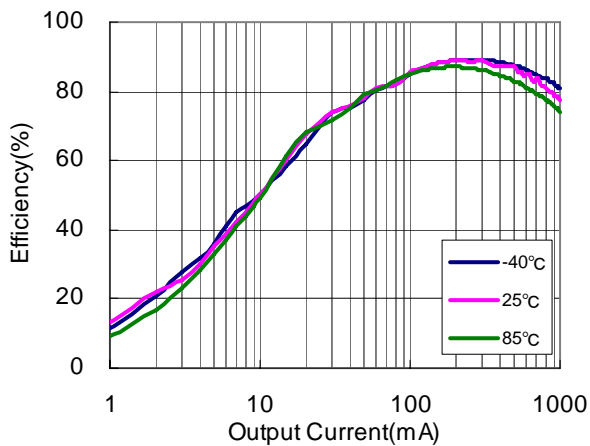

**RP501K151x(PWM/VFM mode change)**  
VIN=MODE=3.6V

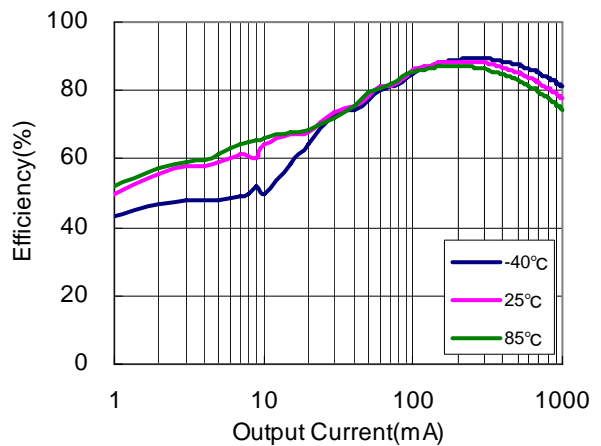

RP501K181x(PWM fixed)

V<sub>IN</sub>=3.6V,MODE=0V

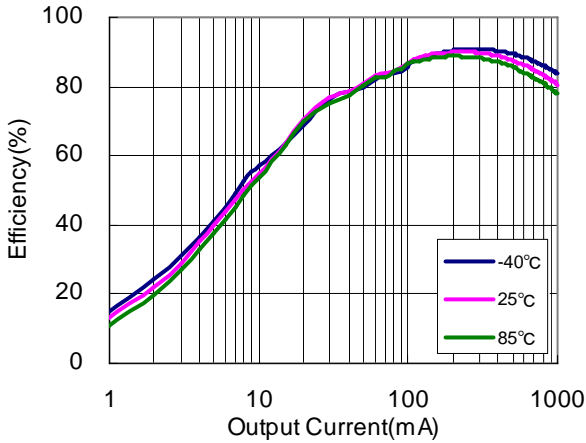

RP501K181x(PWM/VFM mode change)

V<sub>IN</sub>=MODE=3.6V

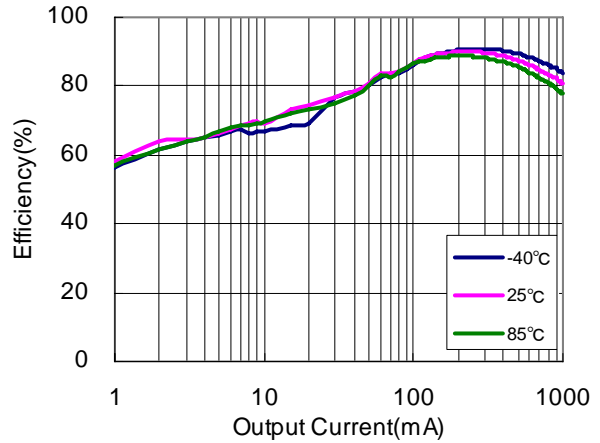

RP501K331x(PWM fixed)

V<sub>IN</sub>=5.0V,MODE=0V

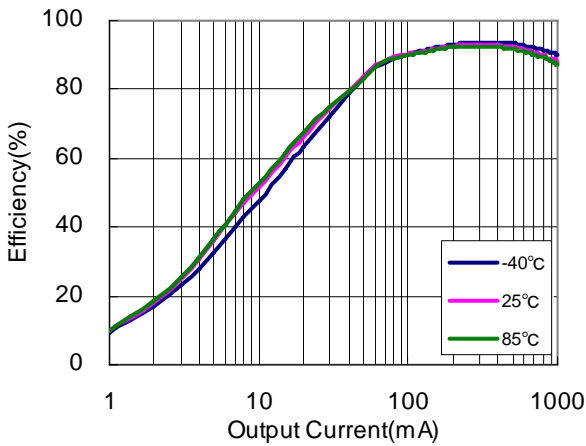

RP501K331x(PWM/VFM mode change)

V<sub>IN</sub>=MODE=5.0V

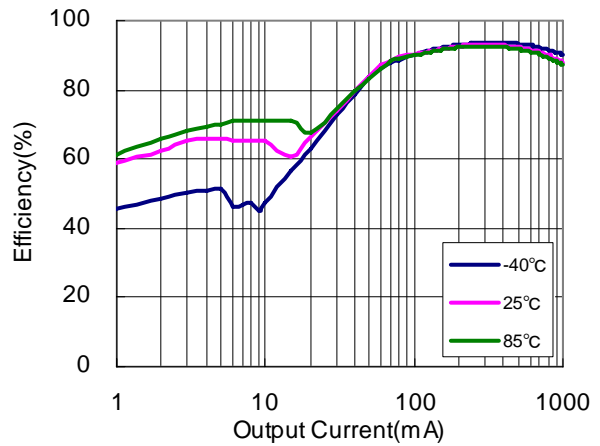

2) Output Voltage vs. Output Current  
2-1 Input Voltage Dependence

RP501K121x(PWM fixed)

MODE=0V

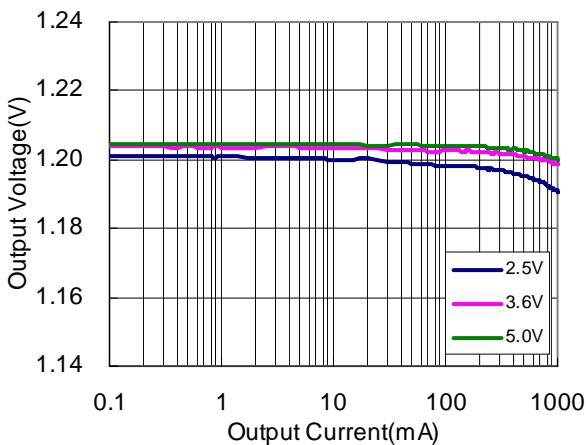

RP501K121x(PWM/VFM mode change)

MODE=V<sub>IN</sub>

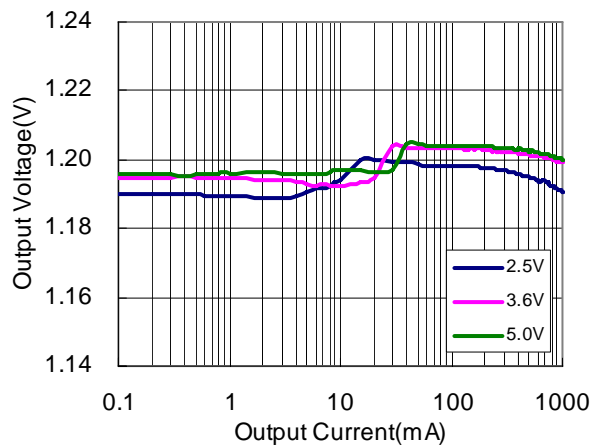

**RP501K151x(PWM fixed)**  
MODE=0V

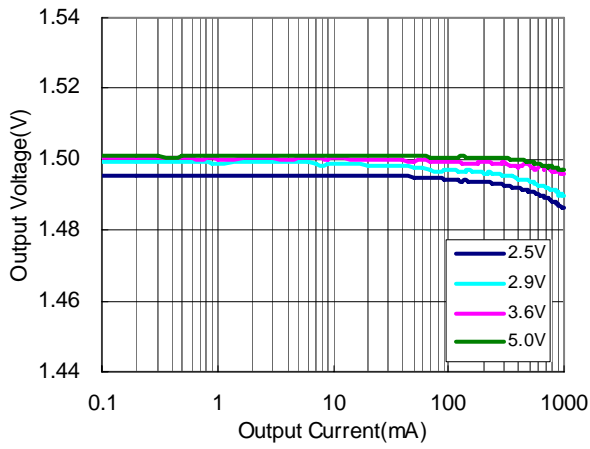

**RP501K151x(PWM/VFM mode change)**  
MODE=VIN

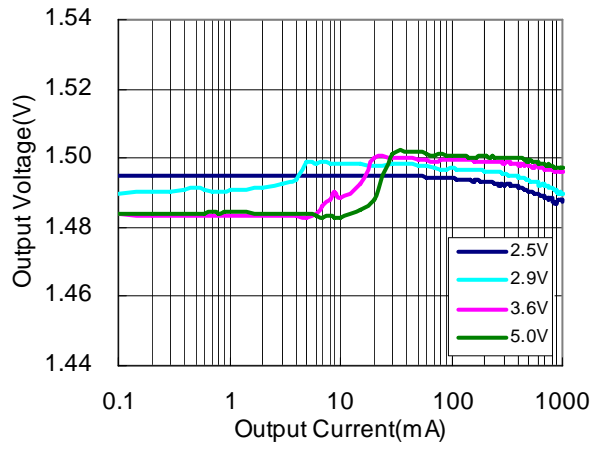

**RP501K181x(PWM fixed)**  
MODE=0V

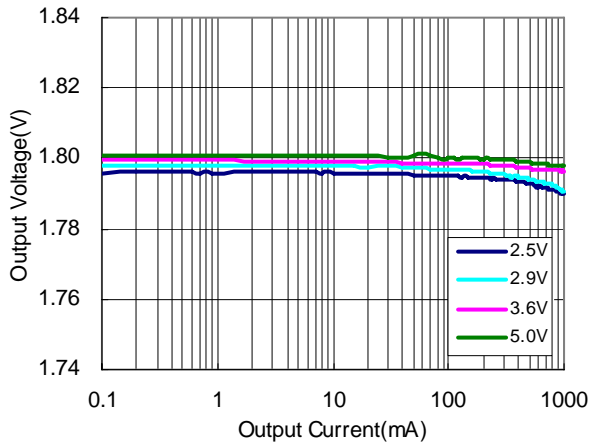

**RP501K181x(PWM/VFM mode change)**  
MODE=VIN

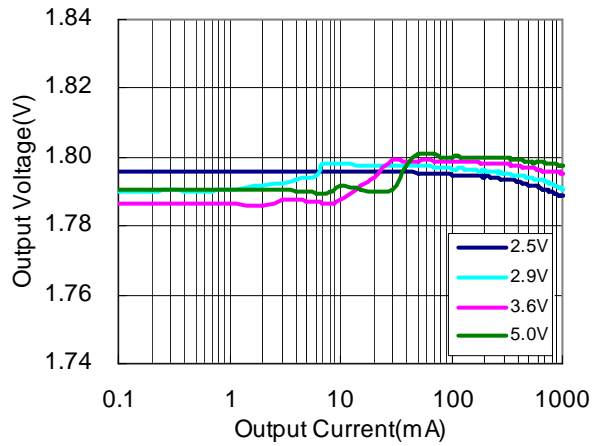

**RP501K331x(PWM fixed)**  
MODE=0V

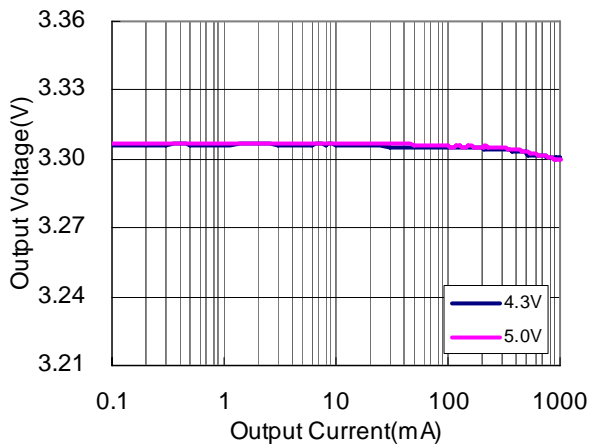

**RP501K331x(PWM/VFM mode change)**  
MODE=VIN

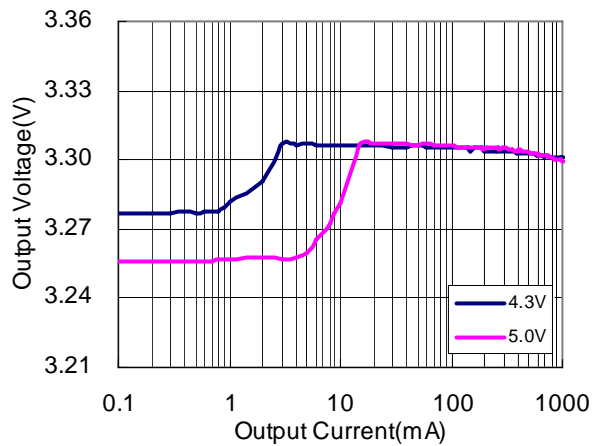

2-2 Temperature Dependence

RP501K121x(PWM fixed)

V<sub>IN</sub>=3.6V,MODE=0V

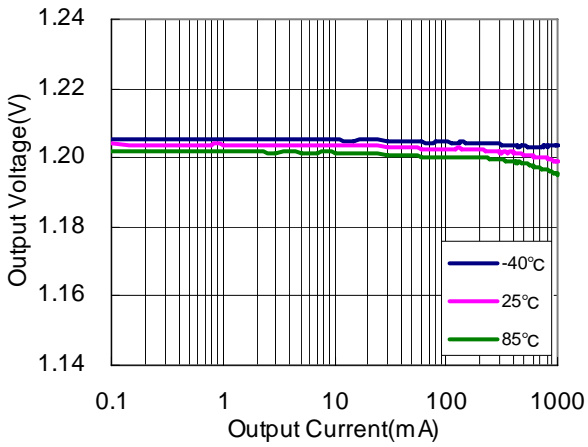

RP501K121x(PWM/VFM mode change)

V<sub>IN</sub>=MODE=3.6V

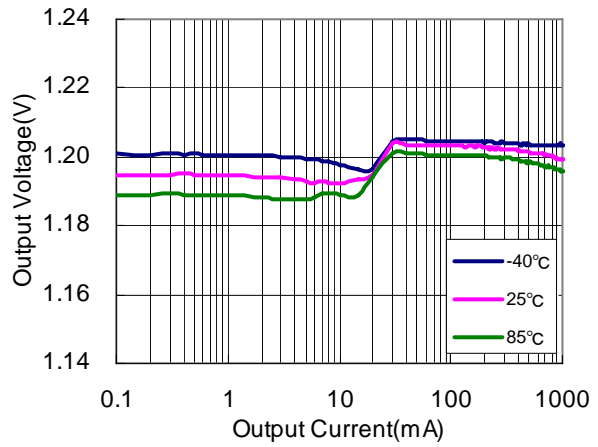

RP501K151x(PWM fixed)

V<sub>IN</sub>=3.6V,MODE=0V

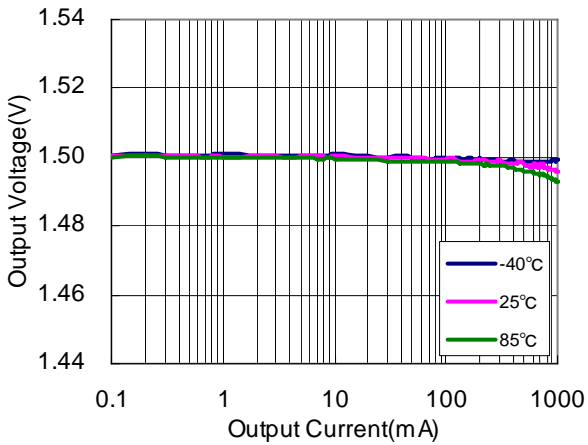

RP501K151x(PWM/VFM mode change)

V<sub>IN</sub>=MODE=3.6V

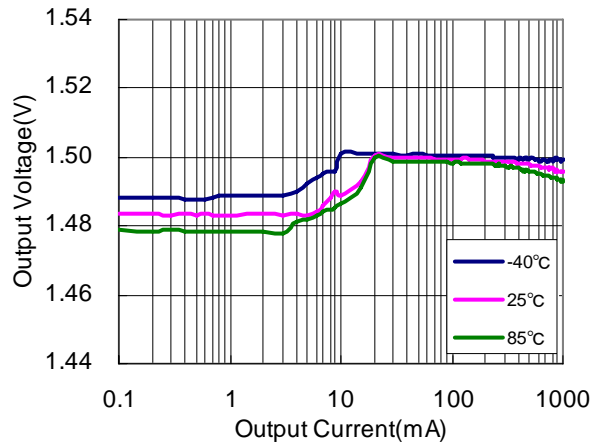

RP501K181x(PWM fixed)

V<sub>IN</sub>=3.6V,MODE=0V

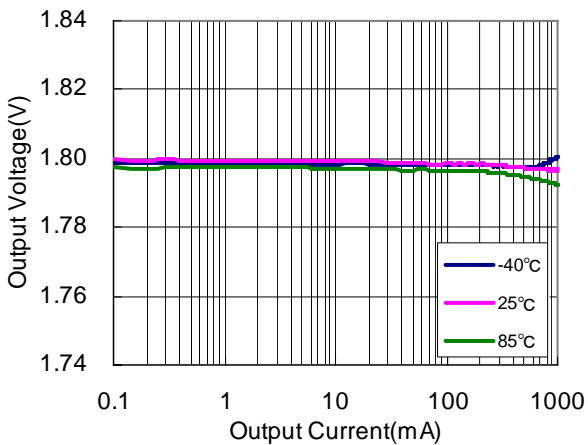

RP501K181x(PWM/VFM mode change)

V<sub>IN</sub>=MODE=3.6V

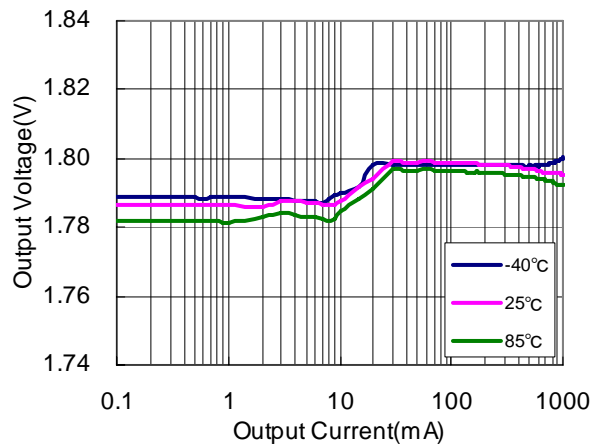

**RP501K331x(PWM fixed)**

$V_{IN}=5.0V, MODE=0V$

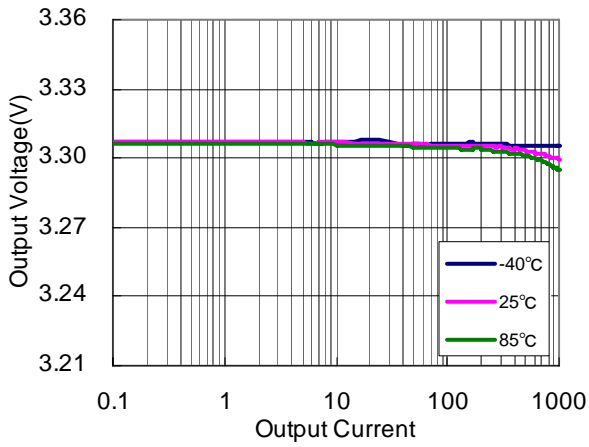

**RP501K331x(PWM/VFM mode change)**

$V_{IN}=MODE=5.0V$

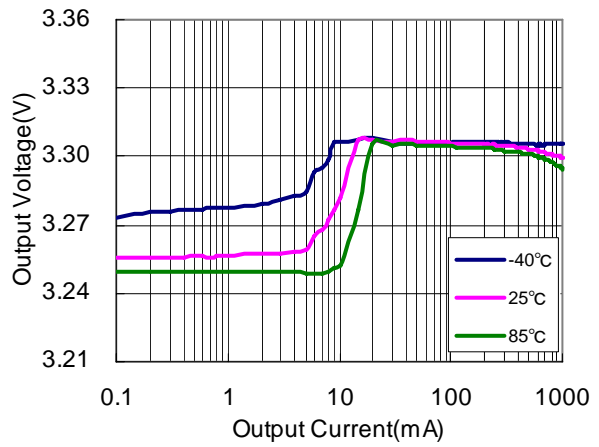

**3) Output Voltage vs. Input Voltage**

**RP501K121x(PWM fixed)**

$MODE=0V$

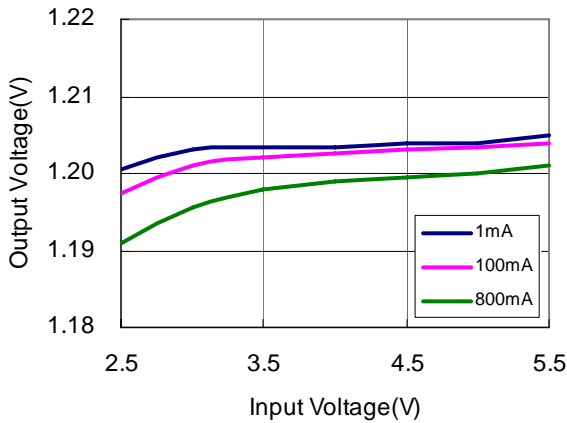

**RP501K121x(PWM/VFM mode change)**

$MODE=V_{IN}, I_{OUT}=1mA$

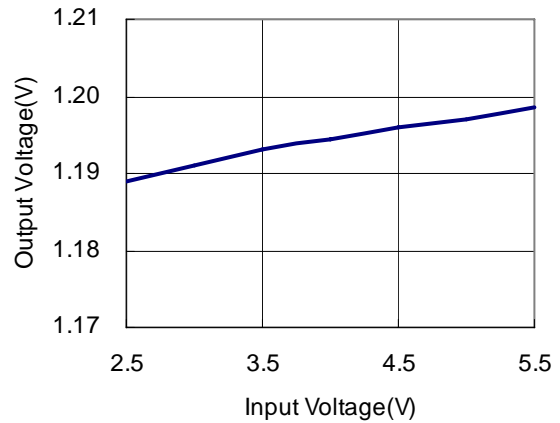

**RP501K151x(PWM fixed)**

$MODE=0V$

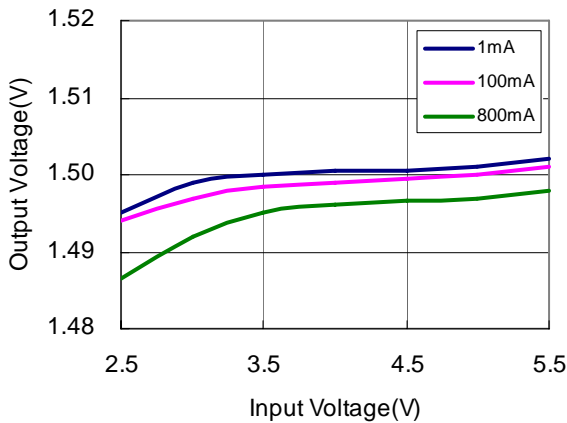

**RP501K151x(PWM/VFM mode change)**

$MODE=V_{IN}, I_{OUT}=1mA$

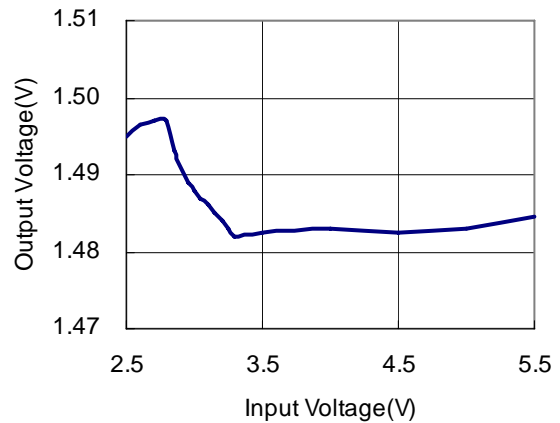

**RP501K181x(PWM fixed)**  
MODE=0V

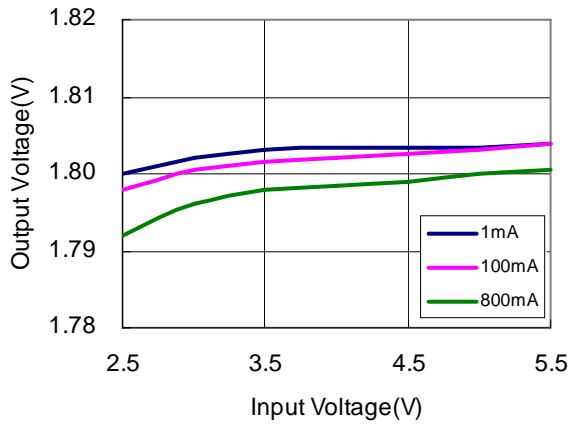

**RP501K181x(PWM/VFM modechange)**  
MODE=VIN ,I<sub>OUT</sub>=1mA

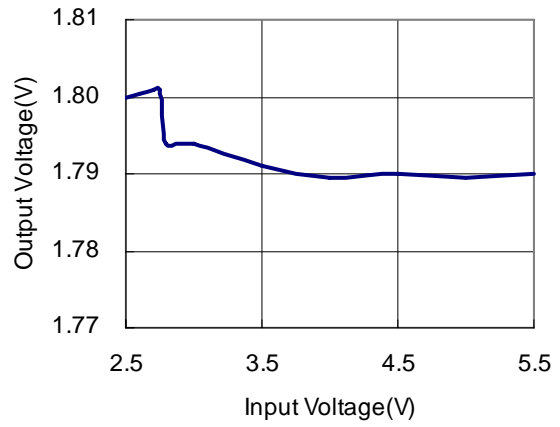

**RP501K331x(PWM fixed)**  
MODE=0V

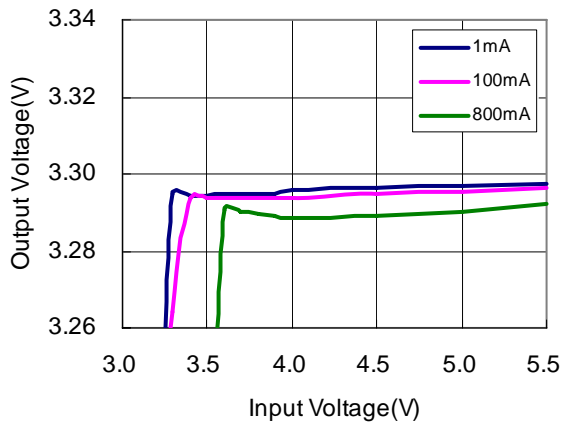

**RP501K331x(PWM/VFM mode change)**  
MODE=VIN ,I<sub>OUT</sub>=1mA

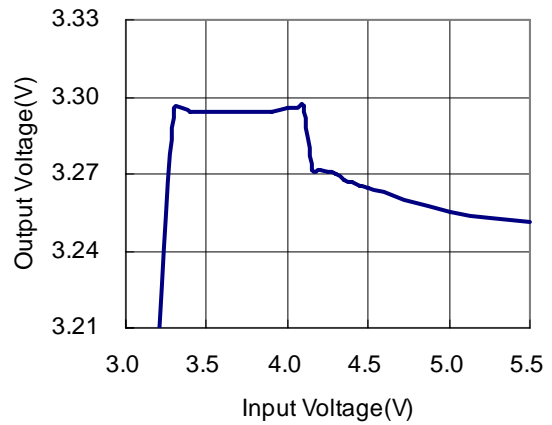

**4) Output Voltage vs. Temperature**

**RP501K121x(PWM fixed)**

V<sub>IN</sub>=3.6V, MODE=0V, I<sub>OUT</sub>=500mA

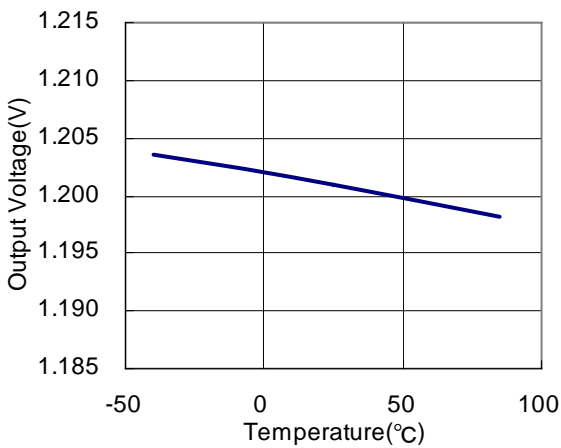

**RP501K121x(PWM/VFM mode change)**

V<sub>IN</sub>=MODE=3.6V ,I<sub>OUT</sub>=1mA

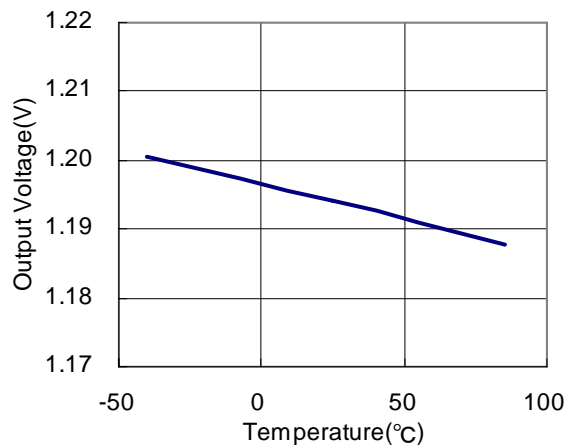

**RP501K151x(PWM fixed)**

$V_{IN}=3.6V, MODE=0V, I_{OUT}=500mA$

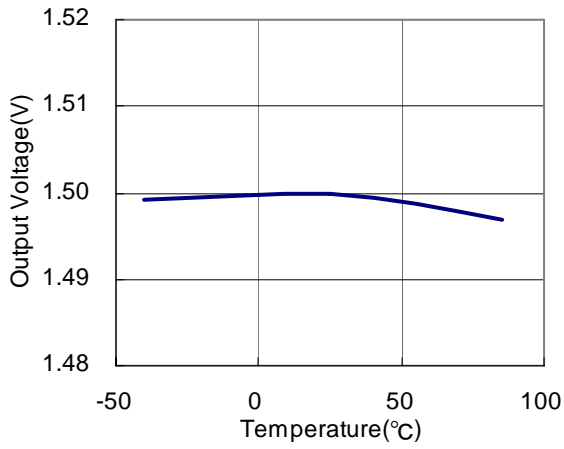

**RP501K151x(PWM/VFM mode change)**

$V_{IN}=MODE=3.6V, I_{OUT}=1mA$

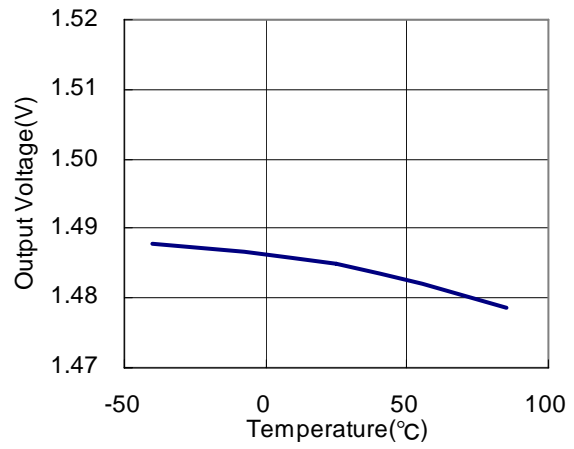

**RP501K181x(PWM fixed)**

$V_{IN}=3.6V, MODE=0V, I_{OUT}=500mA$

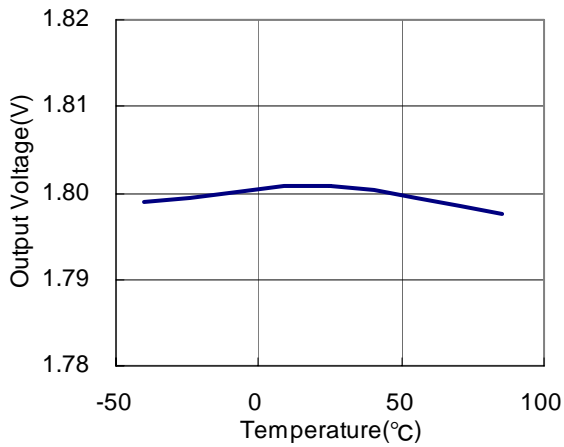

**RP501K181x(PWM/VFM mode change)**

$V_{IN}=MODE=3.6V, I_{OUT}=1mA$

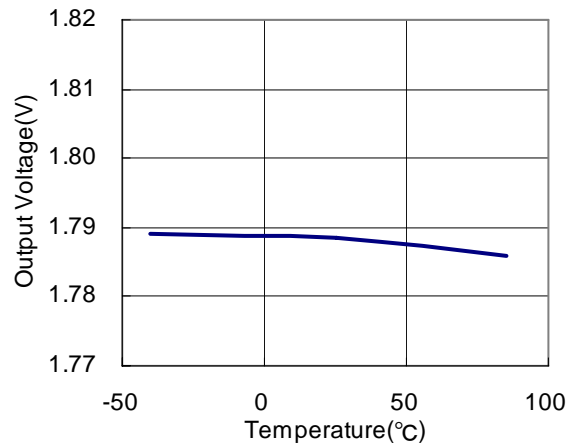

**RP501K331x(PWM fixed)**

$V_{IN}=5.0V, MODE=0V, I_{OUT}=500mA$

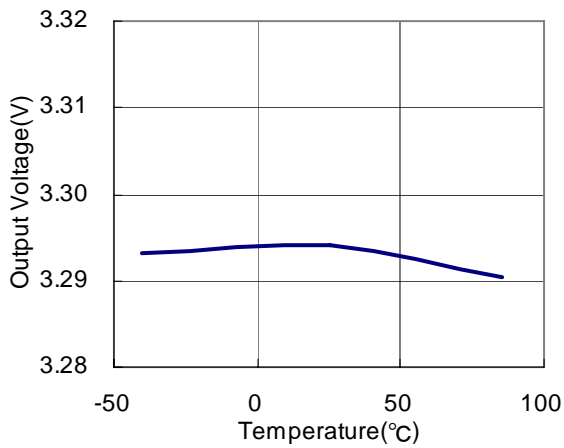

**RP501K331x(PWM/VFM mode change)**

$V_{IN}=MODE=5.0V, I_{OUT}=1mA$

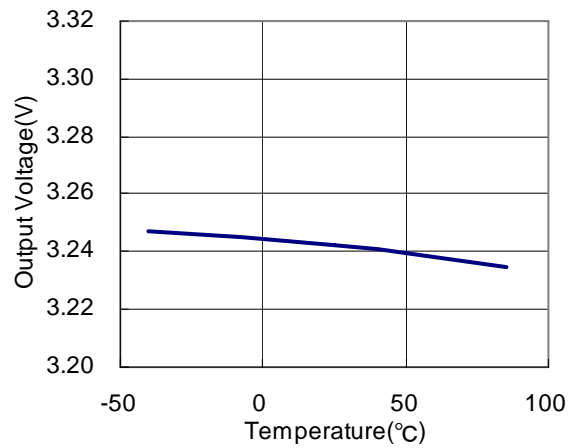

5) DC/DC Output Waveform ( $C_{IN}=10\mu F$ ,  $C_{OUT}=4.7\mu F$ ,  $L=2.2\mu H$ )

RP501K121x(PWM fixed)

$V_{IN}=3.6V, MODE=0V, R_{OUT}=10ohm$

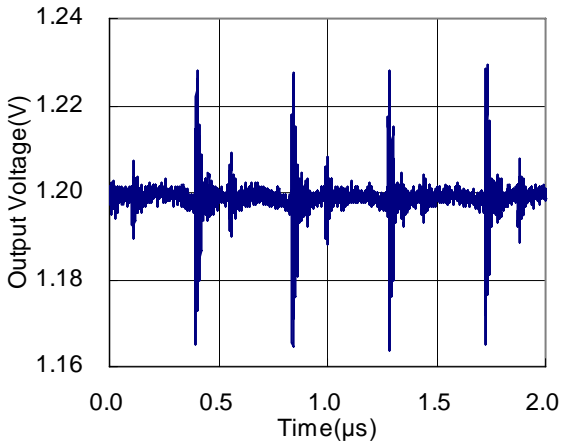

RP501K121x(PWM/VFM mode change)

$V_{IN}=MODE=3.6V, R_{OUT}=1kohm$

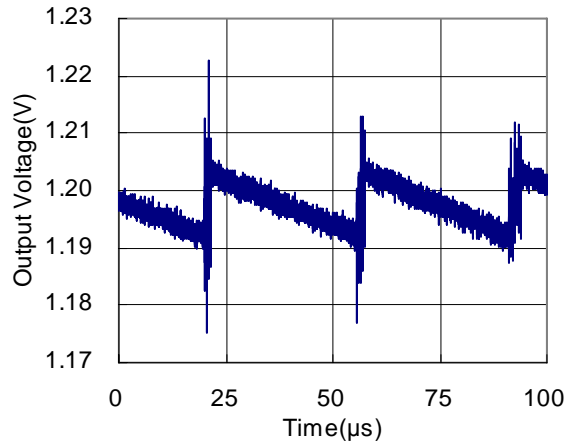

RP501K151x(PWM fixed)

$V_{IN}=3.6V, MODE=0V, R_{OUT}=10ohm$

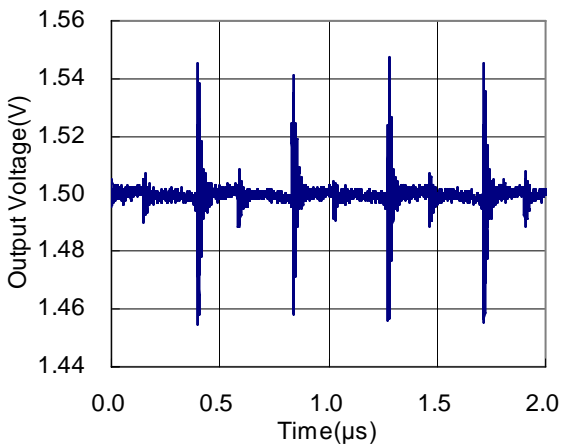

RP501K151x(PWM/VFM mode change)

$V_{IN}=MODE=3.6V, R_{OUT}=1kohm$

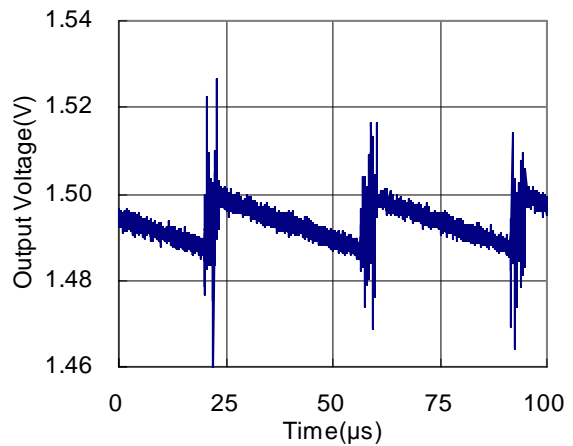

RP501K181x(PWM fixed)

$V_{IN}=3.6V, MODE=0V, R_{OUT}=10ohm$

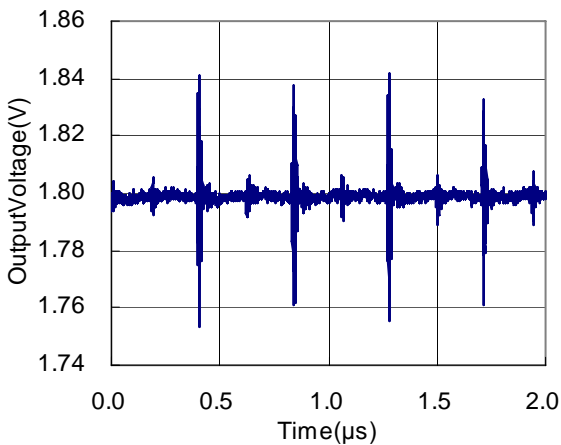

RP501K181x(PWM/VFM mode change)

$V_{IN}=MODE=3.6V, R_{OUT}=1kohm$

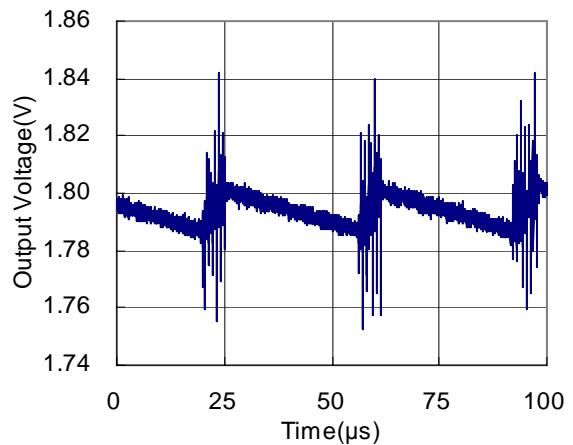



**RP501K331x(PWM fixed)**

V<sub>IN</sub>=5.0V,MODE=0V,R<sub>OUT</sub>=10ohm

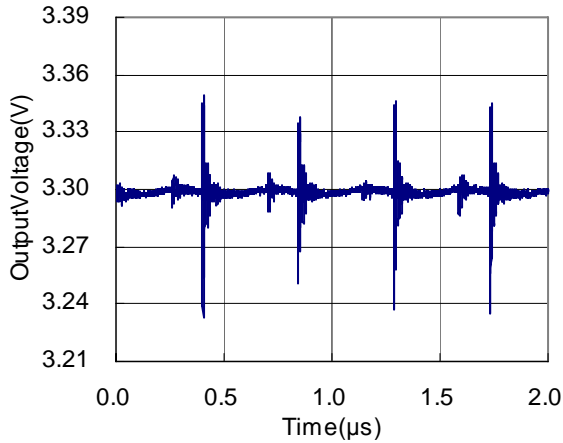

**RP501K331x(PWM/VFM mode change)**

V<sub>IN</sub>=MODE=5.0V ,R<sub>OUT</sub>=1kohm

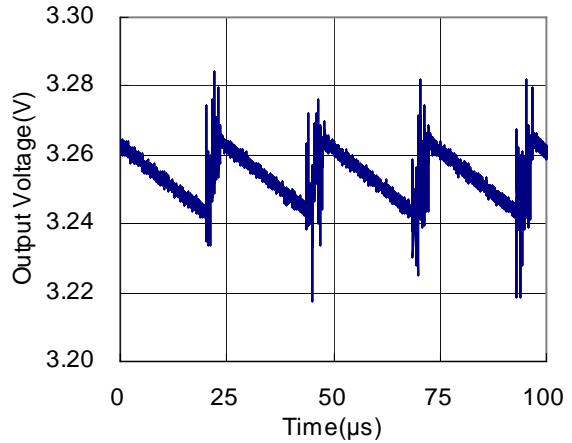

**6) Supply Current 1, 2 vs. Temperature**

**RP501Kxx1x**

V<sub>IN</sub>=5.5V

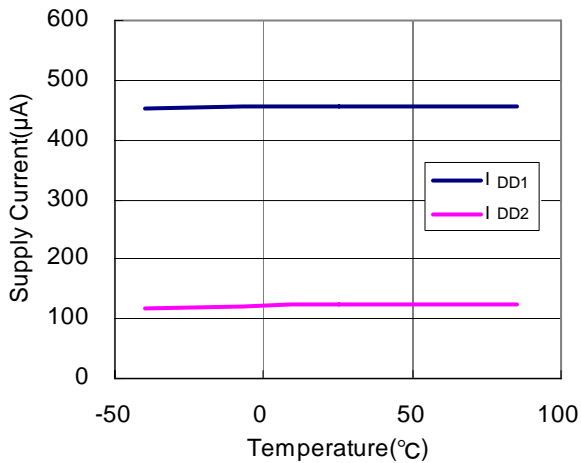

**7) Supply Current 1, 2 vs. Input Voltage**

**RP501Kxx1x**

V<sub>IN</sub>=5.5V

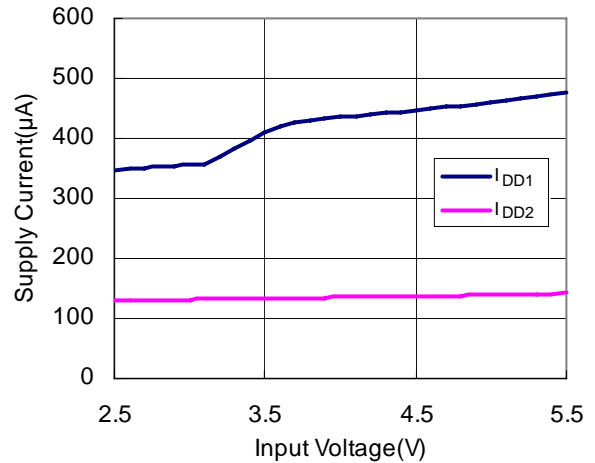

**8) Oscillator Frequency vs. Temperature**

**RP501Kxx1x**

V<sub>IN</sub>=3.6V,R<sub>OUT</sub>=10ohm

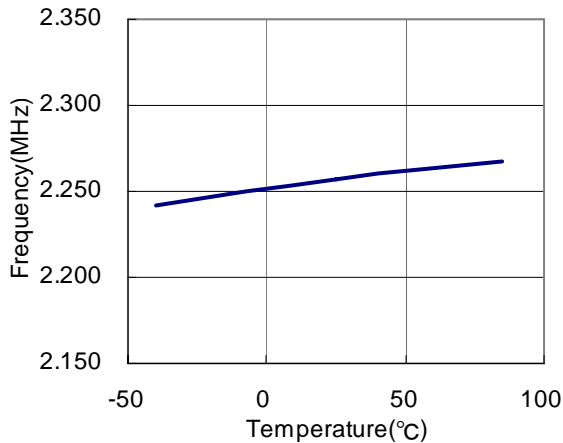

**9) Oscillator Frequency vs. Input Voltage**

**RP501Kxx1x**

V<sub>IN</sub>=3.6V,R<sub>OUT</sub>=10ohm

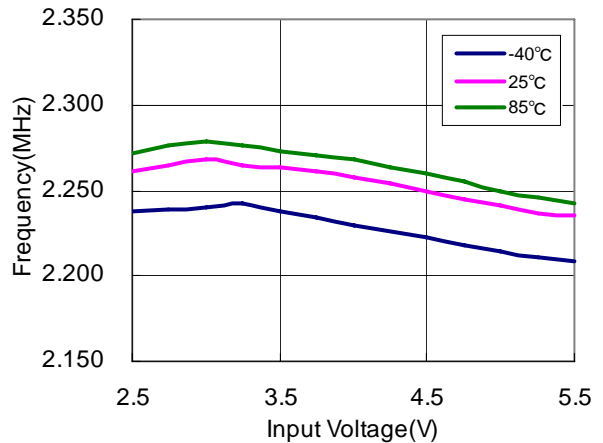

10) Soft-start Time vs. Temperature

RP501Kxx1x

V<sub>IN</sub>=3.6V

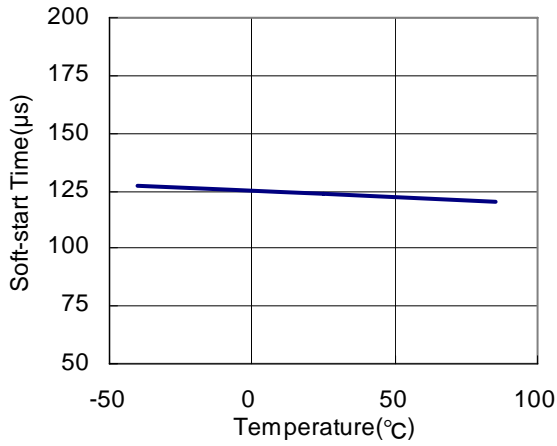

11) Turn on waveform with CE pin (C<sub>IN</sub>=10µF, C<sub>OUT</sub>= 4.7µF, L=2.2µH)

RP501K121x

V<sub>IN</sub>=3.6V, R<sub>OUT</sub>=100ohm

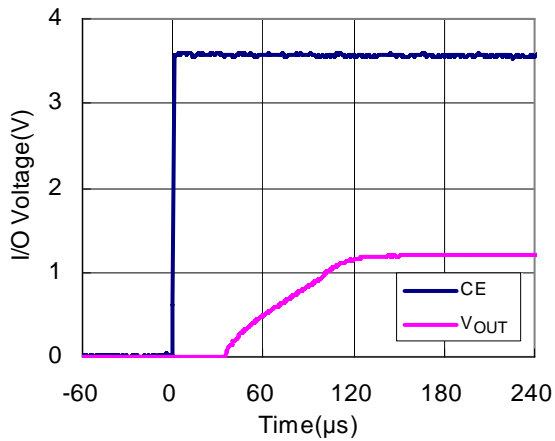

RP501K151x

V<sub>IN</sub>=3.6V, R<sub>OUT</sub>=100ohm

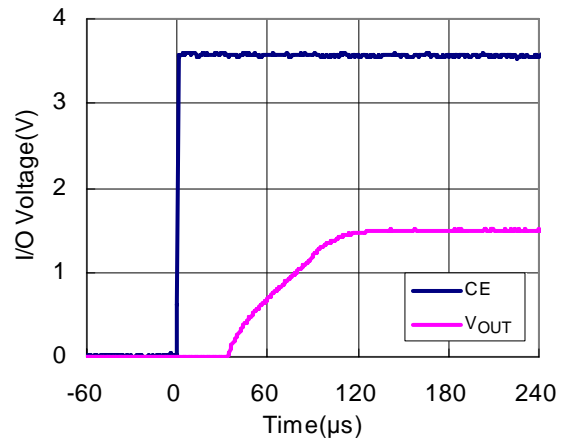

RP501K181x

V<sub>IN</sub>=3.6V, R<sub>OUT</sub>=100ohm

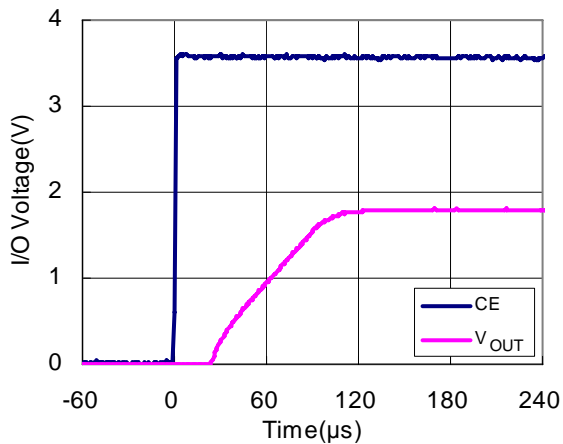

RP501K331x

V<sub>IN</sub>=5.0V, R<sub>OUT</sub>=100ohm

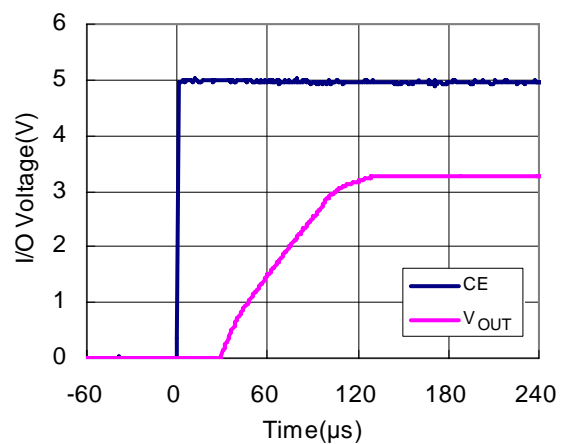

12) Turn off waveform with CE pin ( $C_{IN}=10\mu F$ ,  $C_{OUT}=4.7\mu F$ ,  $L=2.2\mu H$ )

RP501K121B

$V_{IN}=3.6V, R_{OUT}=1k\Omega$

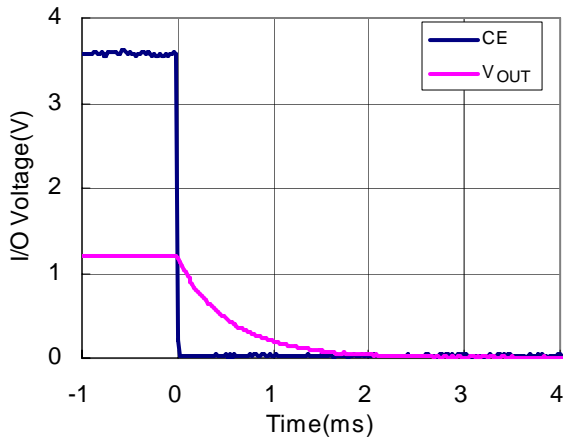

RP501K151B

$V_{IN}=3.6V, R_{OUT}=1k\Omega$

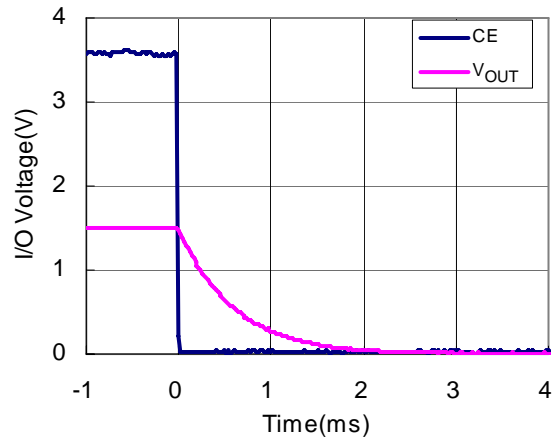

RP501K181A

$V_{IN}=3.6V, R_{OUT}=1k\Omega$

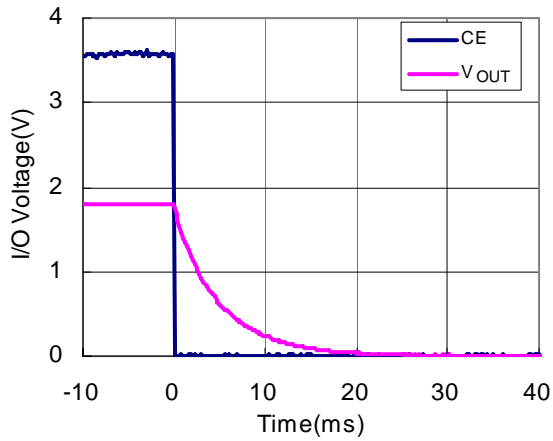

RP501K331A

$V_{IN}=5.0V, R_{OUT}=1k\Omega$

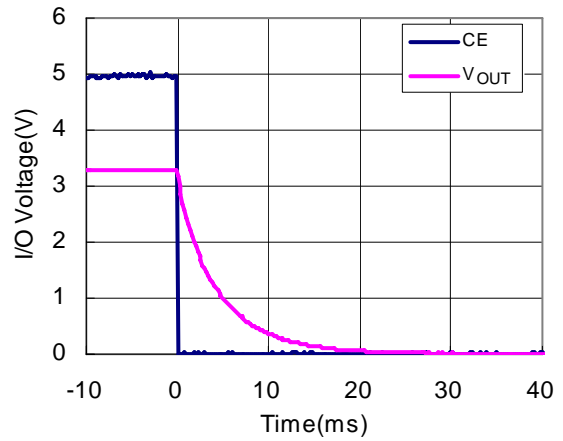

13) UVLO Detector Threshold/ Released Voltage vs. Temperature

RP501Kxx1x

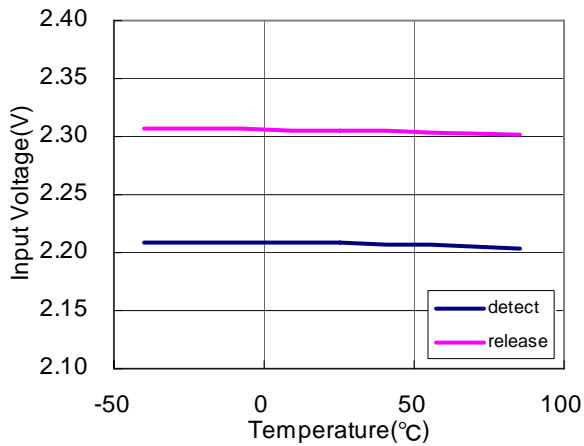

14) CE Input vs. Temperature

RP501Kxx1x

Input Voltage Dependence

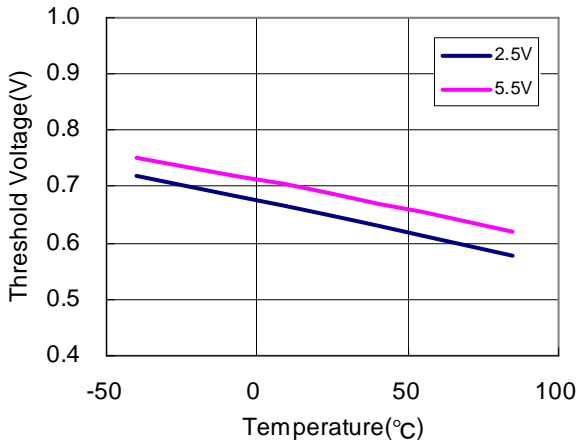

15) MODE Input vs. Temperature

RP501Kxx1x

Input Voltage Dependence

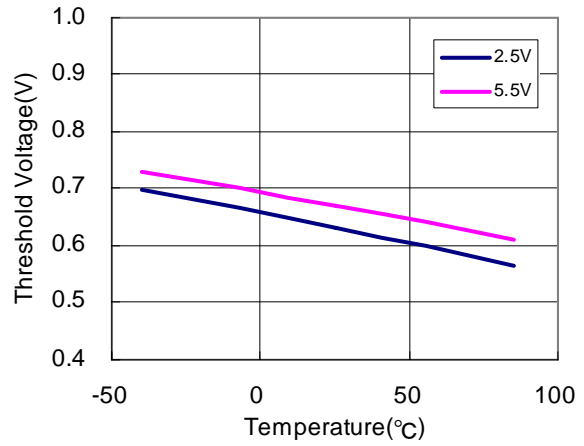

16) Lx Current Limit vs. Temperature

RP501Kxx1x

Input Voltage Dependence

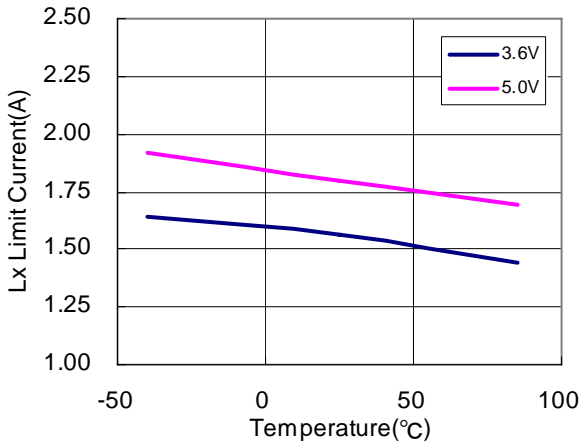

17) Protection Delay Time VS. Temperature

RP501Kxx1x

Input Voltage Dependence

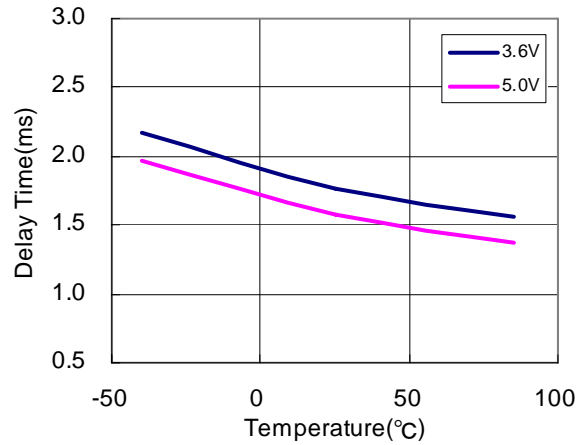

18) Nch Tr. ON Resistance vs. Temperature

RP501Kxx1x

Input Voltage Dependence, I<sub>OUT</sub>=100mA

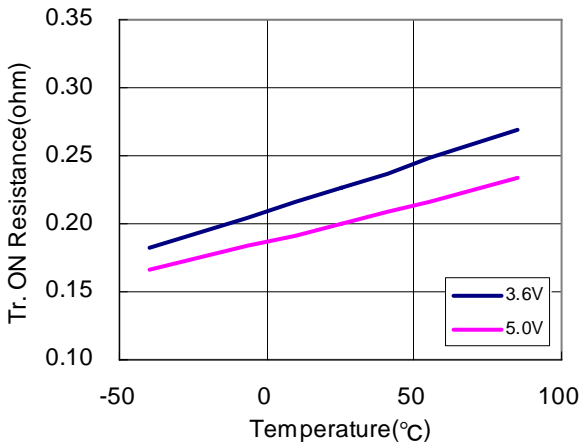

19) Pch Tr. ON Resistance vs. Temperature

RP501Kxx1x

Input Voltage Dependence, I<sub>OUT</sub>=100mA

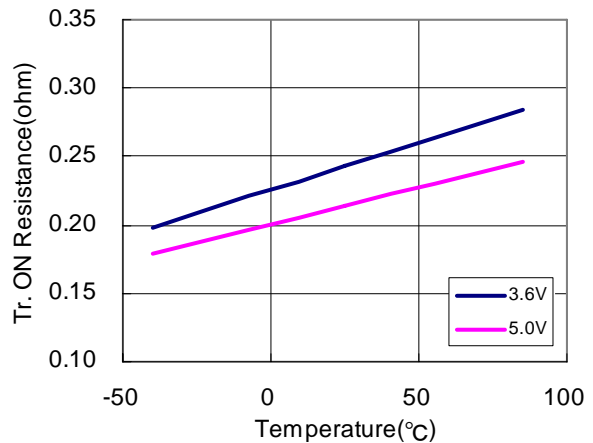

20) Load Transient Response ( $C_{IN}=10\mu F$ ,  $C_{OUT}=4.7\mu F$ ,  $L=2.2\mu H$ )

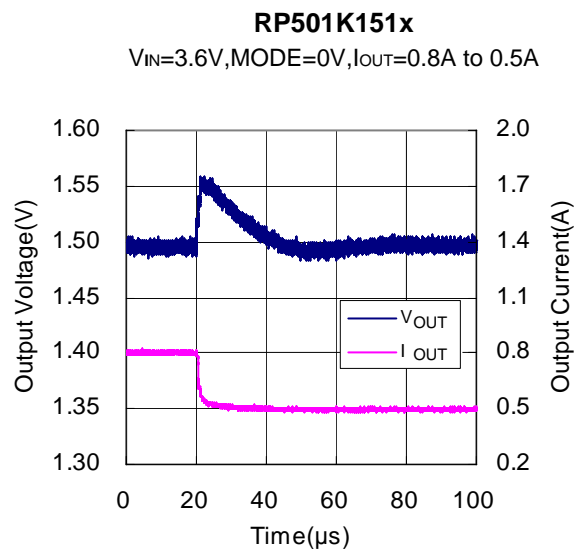
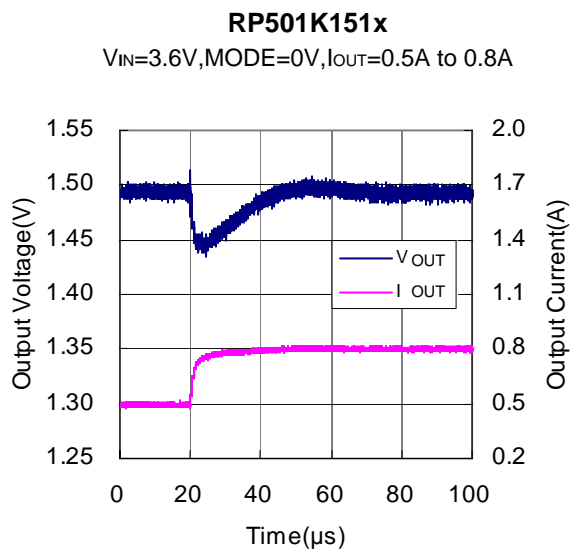
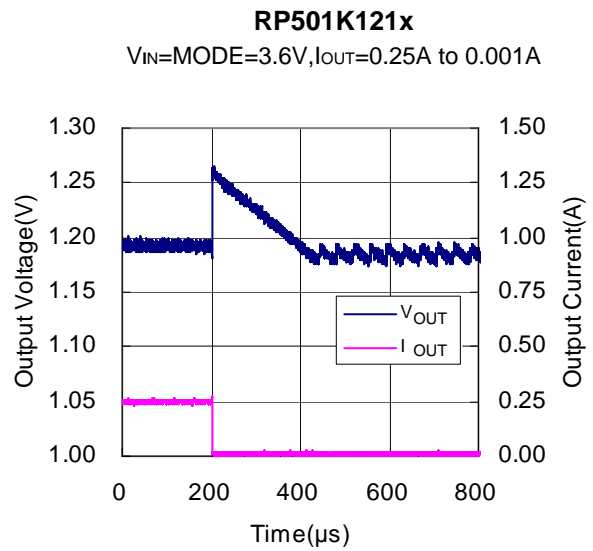
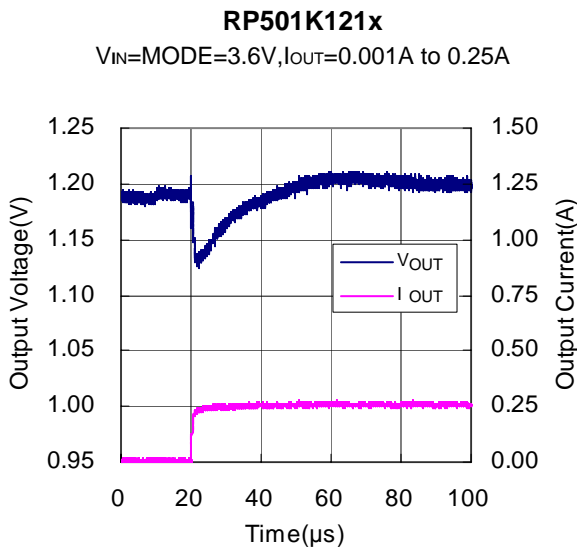
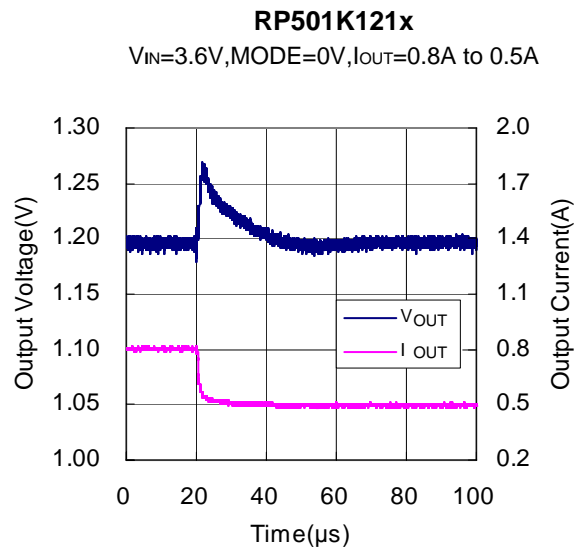
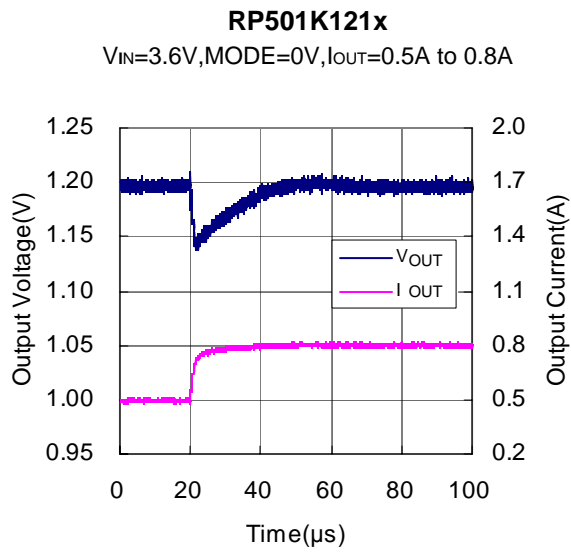

**RP501K151x**

$V_{IN}=MODE=3.6V, I_{OUT}=0.001A$  to  $0.25A$

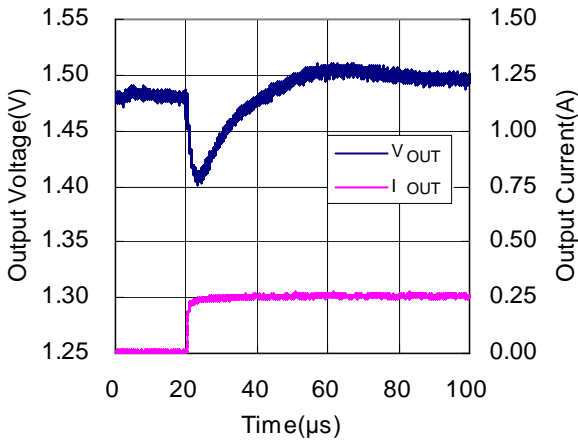

**RP501K151x**

$V_{IN}=MODE=3.6V, I_{OUT}=0.25A$  to  $0.001A$

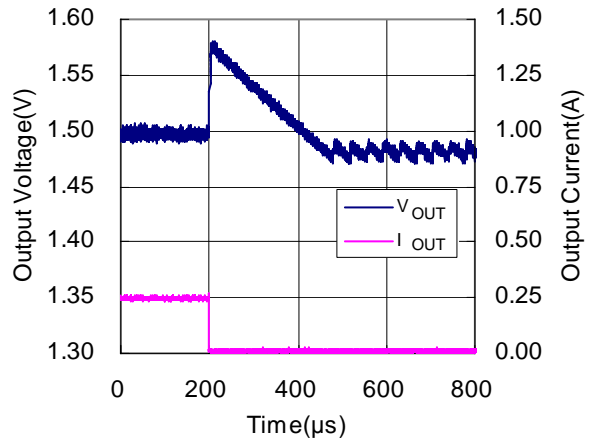

**RP501K181x**

$V_{IN}=3.6V, MODE=0V, I_{OUT}=0.5A$  to  $0.8A$

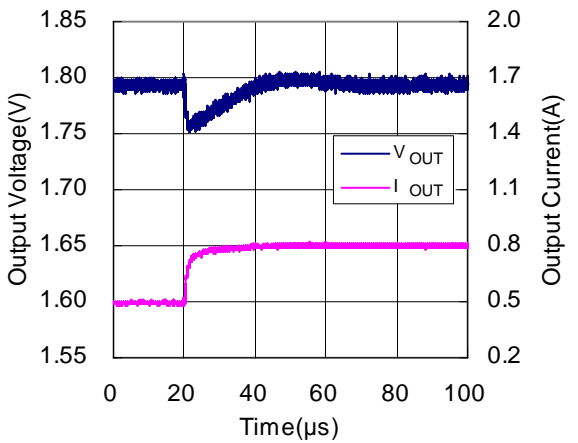

**RP501K181x**

$V_{IN}=3.6V, MODE=0V, I_{OUT}=0.8A$  to  $0.5A$

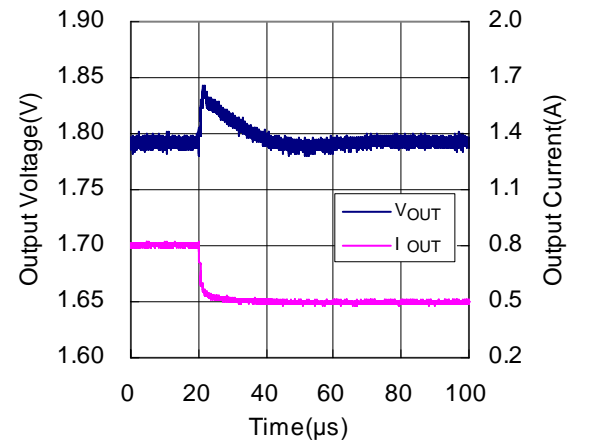

**RP501K181x**

$V_{IN}=MODE=3.6V, I_{OUT}=0.001A$  to  $0.25A$

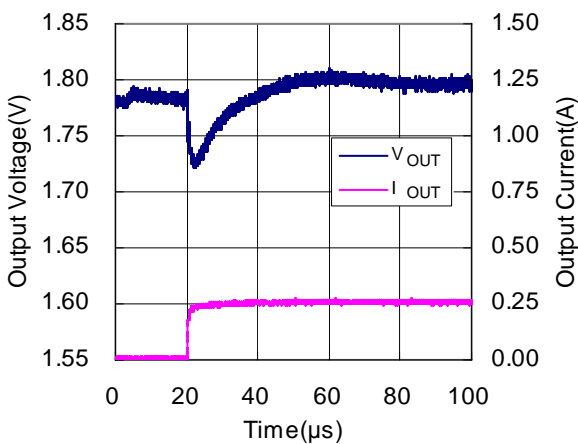

**RP501K181x**

$V_{IN}=MODE=3.6V, I_{OUT}=0.25A$  to  $0.001A$

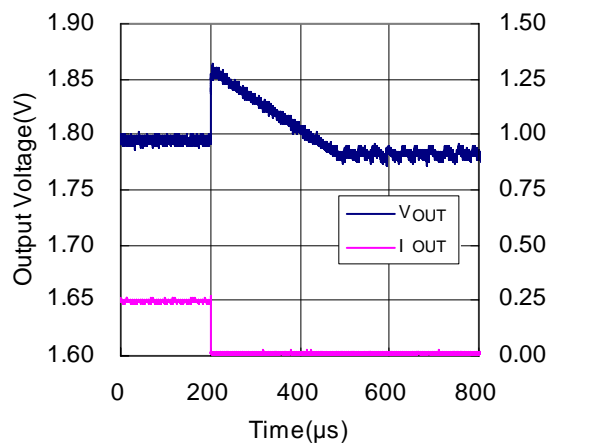

**RP501K331x**

$V_{IN}=5.0V, MODE=0V, I_{OUT}=0.5A$  to  $0.8A$

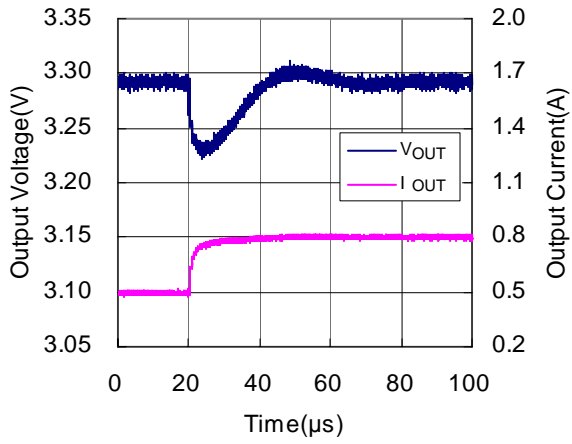

**RP501K331x**

$V_{IN}=5.0V, MODE=0V, I_{OUT}=0.8A$  to  $0.5A$

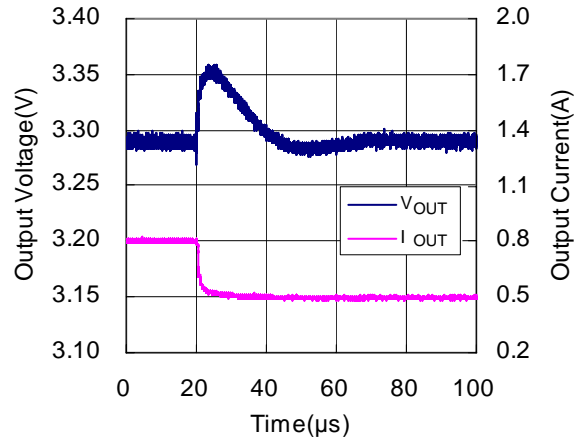

**RP501K331x**

$V_{IN}=MODE=5.0V, I_{OUT}=0.001A$  to  $0.25A$

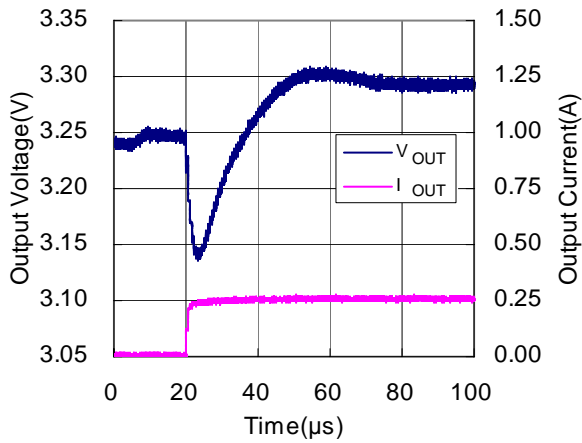

**RP501K331x**

$V_{IN}=MODE=5.0V, I_{OUT}=0.25A$  to  $0.001A$

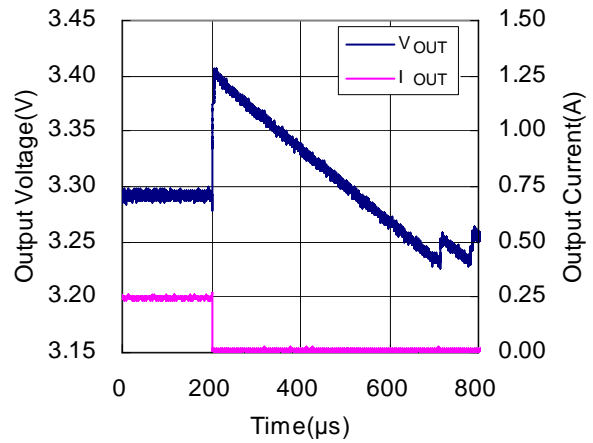



1. The products and the product specifications described in this document are subject to change or discontinuation of production without notice for reasons such as improvement. Therefore, before deciding to use the products, please refer to Ricoh sales representatives for the latest information thereon.
2. The materials in this document may not be copied or otherwise reproduced in whole or in part without prior written consent of Ricoh.
3. Please be sure to take any necessary formalities under relevant laws or regulations before exporting or otherwise taking out of your country the products or the technical information described herein.
4. The technical information described in this document shows typical characteristics of and example application circuits for the products. The release of such information is not to be construed as a warranty of or a grant of license under Ricoh's or any third party's intellectual property rights or any other rights.
5. The products listed in this document are intended and designed for use as general electronic components in standard applications (office equipment, telecommunication equipment, measuring instruments, consumer electronic products, amusement equipment etc.). Those customers intending to use a product in an application requiring extreme quality and reliability, for example, in a highly specific application where the failure or misoperation of the product could result in human injury or death (aircraft, spacevehicle, nuclear reactor control system, traffic control system, automotive and transportation equipment, combustion equipment, safety devices, life support system etc.) should first contact us.
6. We are making our continuous effort to improve the quality and reliability of our products, but semiconductor products are likely to fail with certain probability. In order to prevent any injury to persons or damages to property resulting from such failure, customers should be careful enough to incorporate safety measures in their design, such as redundancy feature, fire containment feature and fail-safe feature. We do not assume any liability or responsibility for any loss or damage arising from misuse or inappropriate use of the products.
7. Anti-radiation design is not implemented in the products described in this document.
8. Please contact Ricoh sales representatives should you have any questions or comments concerning the products or the technical information.



**Ricoh is committed to reducing the environmental loading materials in electrical devices with a view to contributing to the protection of human health and the environment.**

Ricoh has been providing RoHS compliant products since April 1, 2006 and Halogen-free products since April 1, 2012.

**RICOH** RICOH ELECTRONIC DEVICES CO., LTD.

<http://www.e-devices.ricoh.co.jp/en/>

#### Sales & Support Offices

##### **RICOH ELECTRONIC DEVICES CO., LTD.**

**Higashi-Shinagawa Office (International Sales)**  
3-32-3, Higashi-Shinagawa, Shinagawa-ku, Tokyo 140-8655, Japan  
Phone: +81-3-5479-2857 Fax: +81-3-5479-0502

##### **RICOH EUROPE (NETHERLANDS) B.V.**

**Semiconductor Support Centre**  
Prof. W.H. Keesomlaan 1, 1183 DJ Amstelveen, The Netherlands  
Phone: +31-20-5474-309

##### **RICOH ELECTRONIC DEVICES KOREA CO., LTD.**

3F, Haesung Bldg. 504, Teheran-ro, Gangnam-gu, Seoul, 135-725, Korea  
Phone: +82-2-2135-5700 Fax: +82-2-2051-5713

##### **RICOH ELECTRONIC DEVICES SHANGHAI CO., LTD.**

Room 403, No.2 Building, No.690 Bilbo Road, Pu Dong New District, Shanghai 201203,  
People's Republic of China  
Phone: +86-21-5027-3200 Fax: +86-21-5027-3299

##### **RICOH ELECTRONIC DEVICES CO., LTD.**

**Taipei office**  
Room 109, 10F-1, No.51, Hengyang Rd., Taipei City, Taiwan (R.O.C.)  
Phone: +886-2-2313-1621/1622 Fax: +886-2-2313-1623



# Mouser Electronics

Authorized Distributor

Click to View Pricing, Inventory, Delivery & Lifecycle Information:

[RicoH Electronics:](#)

[RP501K191B-TR](#)



Компания «ЭлектроПласт» предлагает заключение долгосрочных отношений при поставках импортных электронных компонентов на взаимовыгодных условиях!

Наши преимущества:

- Оперативные поставки широкого спектра электронных компонентов отечественного и импортного производства напрямую от производителей и с крупнейших мировых складов;
- Поставка более 17-ти миллионов наименований электронных компонентов;
- Поставка сложных, дефицитных, либо снятых с производства позиций;
- Оперативные сроки поставки под заказ (от 5 рабочих дней);
- Экспресс доставка в любую точку России;
- Техническая поддержка проекта, помощь в подборе аналогов, поставка прототипов;
- Система менеджмента качества сертифицирована по Международному стандарту ISO 9001;
- Лицензия ФСБ на осуществление работ с использованием сведений, составляющих государственную тайну;
- Поставка специализированных компонентов (Xilinx, Altera, Analog Devices, Intersil, Interpoint, Microsemi, Aeroflex, Peregrine, Syfer, Eurofarad, Texas Instrument, Miteq, Cobham, E2V, MA-COM, Hittite, Mini-Circuits, General Dynamics и др.);

Помимо этого, одним из направлений компании «ЭлектроПласт» является направление «Источники питания». Мы предлагаем Вам помощь Конструкторского отдела:

- Подбор оптимального решения, техническое обоснование при выборе компонента;
- Подбор аналогов;
- Консультации по применению компонента;
- Поставка образцов и прототипов;
- Техническая поддержка проекта;
- Защита от снятия компонента с производства.



#### Как с нами связаться

**Телефон:** 8 (812) 309 58 32 (многоканальный)

**Факс:** 8 (812) 320-02-42

**Электронная почта:** [org@eplast1.ru](mailto:org@eplast1.ru)

**Адрес:** 198099, г. Санкт-Петербург, ул. Калинина, дом 2, корпус 4, литера А.