

EVALUATION KIT
AVAILABLE

10-Bit, Dual, Nonvolatile, Linear-Taper Digital Potentiometers

General Description

The MAX5494–MAX5499 10-bit (1024-tap), dual, non-volatile, linear-taper, programmable voltage-dividers and variable resistors perform the function of a mechanical potentiometer, but replace the mechanics with a 3-wire SPI™-compatible serial interface. The MAX5494/MAX5495 are dual, 3-terminal, programmable voltage-dividers; the MAX5496/MAX5497 are dual, 2-terminal variable resistors; and the MAX5498/MAX5499 include one 2-terminal variable resistor and one 3-terminal programmable voltage-divider.

The MAX5494–MAX5499 feature an internal, nonvolatile, electrically erasable programmable read-only memory (EEPROM) that stores the wiper position for initialization during power-up. The 3-wire SPI-compatible serial interface allows communication at data rates up to 7MHz.

The MAX5494–MAX5499 are ideal for applications requiring digitally controlled potentiometers. End-to-end resistance values of 10kΩ and 50kΩ are available with a 35ppm/°C end-to-end temperature coefficient. The ratio-metric temperature coefficient is 5ppm/°C for each channel, making these devices ideal for applications requiring low-temperature-coefficient programmable voltage-dividers such as low-drift, programmable-gain amplifiers.

The MAX5494–MAX5499 operate with either a single power supply (+2.7V to +5.25V) or dual power supplies (±2.5V). The devices consume 400μA (max) of supply current when writing data to the nonvolatile memory and 1.5μA (max) of standby supply current. The devices are available in space-saving (5mm x 5mm x 0.8mm), 16-pin TQFN package and are specified over the extended (-40°C to +85°C) temperature range.

Applications

- Gain and Offset Adjustment
- LCD Contrast Adjustment
- Pressure Sensors
- Low-Drift Programmable-Gain Amplifiers
- Mechanical Potentiometer Replacement
- Volume Control

Ordering Information

PART	TEMP RANGE	PIN-PACKAGE	PKG CODE
MAX5494ETE	-40°C to +85°C	16 TQFN-EP*	T1655-2
MAX5495ETE	-40°C to +85°C	16 TQFN-EP*	T1655-2

*EP = Exposed pad.

Ordering Information continued at end of data sheet.

Selector Guide appears at end of data sheet.

SPI is a trademark of Motorola, Inc.



Features

- ◆ Wiper Position Stored in Nonvolatile Memory and Recalled Upon Power-Up
- ◆ 16-Pin, 5mm x 5mm x 0.8mm TQFN Package
- ◆ 35ppm/°C End-to-End Resistance Temperature Coefficient
- ◆ 5ppm/°C Ratiometric Temperature Coefficient
- ◆ 10kΩ and 50kΩ End-to-End Resistor Values
- ◆ 3-Wire SPI-Compatible Serial Interface
- ◆ Reliability (T_A = +85°C)
 - 50,000 Wiper Store Cycles
 - 50 Years Wiper Data Retention
- ◆ 1.5μA (max) Standby Current
- ◆ Single +2.7V to +5.25V Supply Operation
- ◆ Dual ±2.5V Supply Operation

Pin Configurations



Pin Configurations continued at end of data sheet.

MAX5494–MAX5499

10-Bit, Dual, Nonvolatile, Linear-Taper Digital Potentiometers

ABSOLUTE MAXIMUM RATINGS

V _{DD} to GND	-0.3V to +6.0V
V _{SS} to GND	-3.5V to +0.3V
V _{DD} to V _{SS}	-0.3V to +6.0V
H ₁ , H ₂ , L ₁ , L ₂ , W ₁ , W ₂ to V _{SS}	(V _{SS} - 0.3V) to (V _{DD} + 0.3V)
CS, SCLK, DIN to GND	-0.3V to (V _{DD} + 0.3V)
Maximum Continuous Current into H ₋ , L ₋ , and W ₋	
MAX5494/MAX5496/MAX5498	±5.0mA
MAX5495/MAX5497/MAX5499	±1.0mA
Maximum Current Into Other Pins	±50.0mA

Continuous Power Dissipation (T_A = +70°C)

16-Pin TQFN (derate 20.8mW/°C above +70°C)	1666.7mW
Operating Temperature Range	-40°C to +85°C
Junction Temperature	+150°C
Storage Temperature Range	-60°C to +150°C
Lead Temperature (soldering, 10s)	+300°C

Stresses beyond those listed under "Absolute Maximum Ratings" may cause permanent damage to the device. These are stress ratings only, and functional operation of the device at these or any other conditions beyond those indicated in the operational sections of the specifications is not implied. Exposure to absolute maximum rating conditions for extended periods may affect device reliability.

ELECTRICAL CHARACTERISTICS

(V_{DD} = +2.7V to +5.25V, V_{SS} = GND = 0, V_{H-} = V_{DD}, V_{L-} = 0, T_A = -40°C to +85°C, unless otherwise noted. Typical values are at V_{DD} = +5.0V, T_A = +25°C.) (Note 1)

PARAMETER	SYMBOL	CONDITIONS	MIN	TYP	MAX	UNITS
DC PERFORMANCE (MAX5494/MAX5495/MAX5498/MAX5499 Programmable Voltage-Divider)						
Resolution	N		10			Bits
Integral Nonlinearity (Note 2)	INL	V _{DD} = 2.7V			±2	LSB
		V _{DD} = 5V			±2	
Differential Nonlinearity (Note 2)	DNL	V _{DD} = 2.7V			±1	LSB
		V _{DD} = 5V			±1	
End-to-End Resistance Temperature Coefficient	TC _R			35		ppm/°C
Ratiometric Temperature Coefficient				5		ppm/°C
Full-Scale Error	FSE	MAX5494/MAX5498	-4	-2.5	0	LSB
		MAX5495/MAX5499	-4	-0.75	0	
Zero-Scale Error	ZSE	MAX5494/MAX5498	0	3.3	5	LSB
		MAX5495/MAX5499	0	1.45	5	
Wiper Capacitance	C _W			60		pF
End-to-End Resistance	R _{H_L}	MAX5494/MAX5498	7.5	10	12.5	kΩ
		MAX5495/MAX5499	37.5	50	62.5	
Channel-to-Channel Division Ratio Matching		V _{DD} = 3V, midcode: 512	MAX5494	0.05		%
			MAX5495	0.15		
Resistance from W ₋ to L ₋ and H ₋		MAX5494/MAX5498, W ₋ at 15 code, H ₋ and L ₋ shorted to V _{SS} , measure resistance from W ₋ to H ₋ (Figures 4 and 5)	6.3		kΩ	
		MAX5495/MAX5499, W ₋ at 15 code, H ₋ and L ₋ shorted to V _{SS} , measure resistance from W ₋ to H ₋ (Figures 4 and 5)	25			

10-Bit, Dual, Nonvolatile, Linear-Taper Digital Potentiometers

MAX5494-MAX5499

ELECTRICAL CHARACTERISTICS (continued)

($V_{DD} = +2.7V$ to $+5.25V$, $V_{SS} = GND = 0$, $V_{H_} = V_{DD}$, $V_{L_} = 0$, $T_A = -40^{\circ}C$ to $+85^{\circ}C$, unless otherwise noted. Typical values are at $V_{DD} = +5.0V$, $T_A = +25^{\circ}C$.) (Note 1)

PARAMETER	SYMBOL	CONDITIONS		MIN	TYP	MAX	UNITS
DC PERFORMANCE (MAX5496-MAX5499 Variable Resistor)							
Resolution	N			10			Bits
Integral Nonlinearity (Note 3)	INL_R	$V_{DD} = 2.7V$			-1.6		LSB
		$V_{DD} = 3V$		-4	-1.4	+4	
		$V_{DD} = 5V$		-4	-1.3	+4	
Differential Nonlinearity (Note 3)	DNL_R	$V_{DD} = 2.7V$			+0.45		LSB
		$V_{DD} = 3V$		-1	+0.4	+1	
		$V_{DD} = 5V$		-1	+0.35	+1	
Variable-Resistor Temperature Coefficient	TC _{VR}	$V_{DD} = 3V$ to $5.25V$; code = 128 to 1024			35		ppm/ $^{\circ}C$
Wiper Resistance	R _W	$V_{DD} \geq 3V$ (Note 4)			50		Ω
Wiper Capacitance	C _{WR}				60		pF
Full-Scale Wiper-to-End Resistance	R _{W-L}	MAX5496/MAX5498		7.5	10	12.5	k Ω
		MAX5497/MAX5499		37.5	50	62.5	
Zero-Scale Resistor Error	R _Z	Code = 0	MAX5494/MAX5498	70			Ω
			MAX5495/MAX5499	110			
Two-Channel Resistance Matching		$V_{DD} = 3V$ to $5.25V$	MAX5496/MAX5498, Code >128	0.1			%
			MAX5497/MAX5499, Code >200	0.15			
DIGITAL INPUTS (\overline{CS}, SCLK, DIN) (Note 5)							
Input High Voltage	V _{IH}	Single-supply operation	$V_{DD} = 3.6V$ to $5.25V$	2.4			V
			$V_{DD} = 2.7V$ to $3.6V$	0.7 x V_{DD}			
		Dual-supply operation	With respect to GND, $V_{DD} = 2.5V$, $V_{SS} = -2.5V$	2.0			
Input Low Voltage	V _{IL}	Single-supply operation	$V_{DD} = 2.7V$ to $5.25V$			0.8	V
		Dual-supply operation	With respect to GND, $V_{DD} = 2.5V$, $V_{SS} = -2.5V$			0.6	
Input Leakage Current	I _{IN}					± 1	μA
Input Capacitance	C _{IN}				5		pF
DYNAMIC CHARACTERISTICS							
Wiper -3dB Bandwidth	BW	Wiper at code 495 (01111 01111), 10pF load at wiper	MAX5494/MAX5498	250			kHz
			MAX5495/MAX5499	50			

10-Bit, Dual, Nonvolatile, Linear-Taper Digital Potentiometers

ELECTRICAL CHARACTERISTICS (continued)

($V_{DD} = +2.7V$ to $+5.25V$, $V_{SS} = GND = 0$, $V_{H_} = V_{DD}$, $V_{L_} = 0$, $T_A = -40^{\circ}C$ to $+85^{\circ}C$, unless otherwise noted. Typical values are at $V_{DD} = +5.0V$, $T_A = +25^{\circ}C$.) (Note 1)

PARAMETER	SYMBOL	CONDITIONS	MIN	TYP	MAX	UNITS
Total Harmonic Distortion	THD	MAX5494/MAX5498; $V_{DD} = 3V$; wiper at code 495; 10kHz, 1V _{RMS} signal is applied at H ₋ ; 10pF load at wiper		0.026		%
		MAX5495/MAX5499; $V_{DD} = 3V$; wiper at code 495; 10kHz, 1V _{RMS} signal is applied at H ₋ ; 10pF load at wiper		0.03		
Analog Crosstalk		CH2 = 11111 11111, CH1 = 01111 01111, $C_{W_} = 10pF$, $V_{H1} = V_{DD} = +2.5V$, $V_{L1} = V_{SS} = -2.5V$, measure V_{W1} with $V_{W2} = 5V_{p-p}$ at $f = 1kHz$		-93		dB
NONVOLATILE MEMORY RELIABILITY						
Data Retention		$T_A = +85^{\circ}C$		50		Years
Endurance		$T_A = +25^{\circ}C$		200,000		Stores
		$T_A = +85^{\circ}C$		50,000		
POWER SUPPLIES						
Single-Supply Voltage	V_{DD}	$V_{SS} = GND = 0$	2.70		5.25	V
Dual-Supply Voltage	V_{DD}	$GND = 0$	2.50		5.25	V
	V_{SS}	$(V_{DD} - V_{SS}) \leq 5.25V$	-2.5		-0.2	
Average Programming Current	I_{PG}	During nonvolatile write only; digital inputs = V_{DD} or GND		220	400	μA
Peak Programming Current		During nonvolatile write only; digital inputs = V_{DD} or GND		4		mA
Standby Current	I_{DD}	Digital inputs = V_{DD} or GND, $T_A = +25^{\circ}C$		0.6	1.5	μA

10-Bit, Dual, Nonvolatile, Linear-Taper Digital Potentiometers

MAX5494-MAX5499

TIMING CHARACTERISTICS

($V_{DD} = +2.7V$ to $+5.25V$, $V_{SS} = GND = 0$, $V_{H_} = V_{DD}$, $V_{L_} = 0$, $T_A = -40^{\circ}C$ to $+85^{\circ}C$, unless otherwise noted. Typical values are at $V_{DD} = +5.0V$, $T_A = +25^{\circ}C$.) (Note 1)

PARAMETER	SYMBOL	CONDITIONS	MIN	TYP	MAX	UNITS
ANALOG SECTION						
Wiper Settling Time (Note 6)	t _s	MAX5494/MAX5498		5		μs
		MAX5495/MAX5499		22		
SPI-COMPATIBLE SERIAL INTERFACE (Figure 6)						
SCLK Frequency	f _{SCLK}				7	MHz
SCLK Clock Period	t _{CP}		140			ns
SCLK Pulse-Width High	t _{CH}		60			ns
SCLK Pulse-Width Low	t _{CL}		60			ns
\overline{CS} Fall to SCLK Rise Setup	t _{CSS}		60			ns
SCLK Rise to \overline{CS} Rise Hold	t _{CSH}		0			ns
DIN to SCLK Setup	t _{DS}		40			ns
DIN Hold After SCLK	t _{DH}		0			ns
SCLK Rise to \overline{CS} Fall Delay	t _{CS0}		15			ns
\overline{CS} Rise to SCLK Rise Hold	t _{CS1}		60			ns
\overline{CS} Pulse-Width High	t _{CSW}		150			ns
Write NV Register Busy Time	t _{BUSY}				12	ms

Note 1: 100% production tested at $T_A = +25^{\circ}C$ and $T_A = +85^{\circ}C$. Guaranteed by design to $T_A = -40^{\circ}C$.

Note 2: The DNL and INL are measured for the voltage-divider with $H_ = V_{DD}$ and $L_ = V_{SS}$. The wiper terminal ($W_$) is unloaded and measured with a high-input-impedance voltmeter.

Note 3: The DNL and INL are measured with $L_ = V_{SS} = 0$. For $V_{DD} = 5V$, the wiper terminal is driven with a current source of $I_W = 80\mu A$ for the $50k\Omega$ device and $I_W = 400\mu A$ for the $10k\Omega$ device. For $V_{DD} = 3V$, the wiper terminal is driven with a current source of $I_W = 40\mu A$ for the $50k\Omega$ device and $I_W = 200\mu A$ for the $10k\Omega$ device.

Note 4: The wiper resistance is measured using the source currents given in Note 3.

Note 5: The device draws higher supply current when the digital inputs are driven with voltages between ($V_{DD} - 0.5V$) and ($GND + 0.5V$). See the Supply Current vs. Digital Input Voltage graph in the *Typical Operating Characteristics*.

Note 6: Wiper settling test condition uses the voltage-divider with a $10pF$ load on $W_$. Transition code from 0 to 495 and measure the time from \overline{CS} going high to the wiper voltage settling to within 0.5% of its final value.

10-Bit, Dual, Nonvolatile, Linear-Taper Digital Potentiometers

Typical Operating Characteristics

($V_{DD} = +5.0V$, $V_{SS} = 0$, $T_A = +25^\circ C$, unless otherwise noted.)



10-Bit, Dual, Nonvolatile, Linear-Taper Digital Potentiometers

Typical Operating Characteristics (continued)

($V_{DD} = +5.0V$, $V_{SS} = 0$, $T_A = +25^\circ C$, unless otherwise noted.)

MAX5494-MAX5499

**WIPER RESISTANCE vs. WIPER VOLTAGE
(VARIABLE RESISTOR)**



**END-TO-END RESISTANCE (R_{HL})
% CHANGE vs. TEMPERATURE
(VOLTAGE-DIVIDER)**

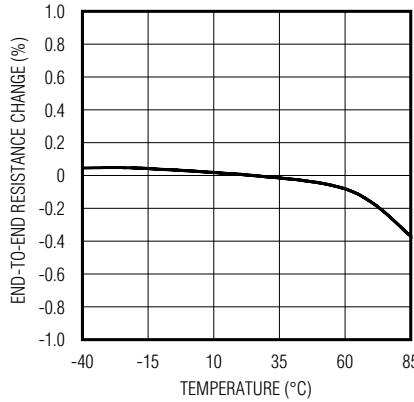

**WIPER-TO-END RESISTANCE (R_{WL})
% CHANGE vs. TEMPERATURE
(VARIABLE RESISTOR)**

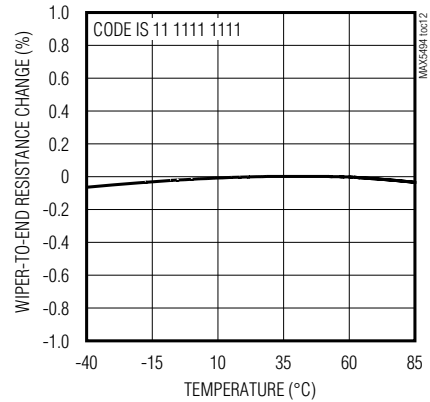

**STANDBY SUPPLY CURRENT
vs. TEMPERATURE**

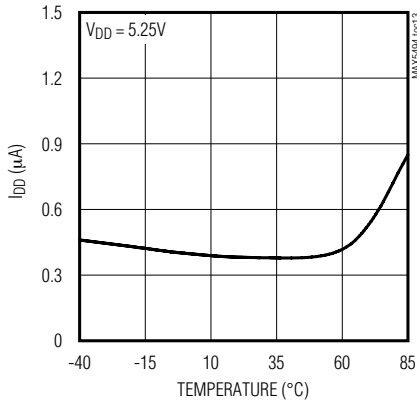

**DIGITAL SUPPLY CURRENT
vs. DIGITAL INPUT VOLTAGE**

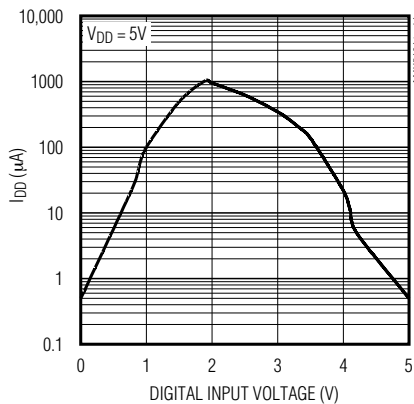

**RATIOMETRIC TEMPERATURE
COEFFICIENT vs. CODE**

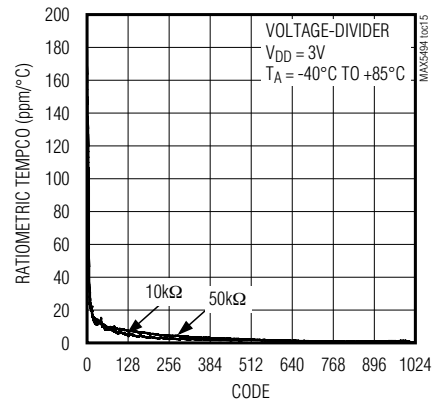

**VARIABLE RESISTOR TEMPERATURE
COEFFICIENT vs. CODE**

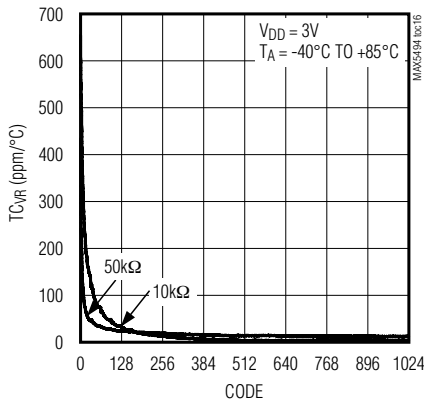

**TAP-TO-TAP SWITCHING TRANSIENT
(MAX5494/MAX5498)**



**TAP-TO-TAP SWITCHING TRANSIENT
(MAX5495/MAX5499)**

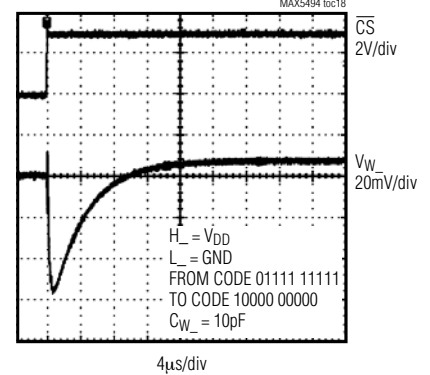

10-Bit, Dual, Nonvolatile, Linear-Taper Digital Potentiometers

Typical Operating Characteristics (continued)

($V_{DD} = +5.0V$, $V_{SS} = 0$, $T_A = +25^\circ C$, unless otherwise noted.)



10-Bit, Dual, Nonvolatile, Linear-Taper Digital Potentiometers

Pin Descriptions

MAX5494-MAX5499

PIN			NAME	FUNCTION
MAX5494/ MAX5495	MAX5496/ MAX5497	MAX5498/ MAX5499		
1	1	1	$\overline{\text{CS}}$	Active-Low Chip-Select Input. Drive $\overline{\text{CS}}$ low to enable the serial interface. Drive $\overline{\text{CS}}$ high to disable the serial interface and put the device in standby mode.
2	2	2	W2	Wiper Terminal 2
3	3	3	L2	Low Terminal 2
4	—	—	H2	High Terminal 2
5	5	5	V _{DD}	Positive Power-Supply Input. $2.7\text{V} \leq V_{\text{DD}} \leq 5.25\text{V}$. Bypass with a 0.1 μF capacitor from V _{DD} to GND as close to the device as possible
6, 7, 14, 15	6, 7, 14, 15	6, 7, 14, 15	N.C.	No Connection. Not internally connected.
8	8	8	V _{SS}	Negative Power-Supply Input. Single-supply operation: V _{SS} = GND = 0. Dual-supply operation: $-2.5\text{V} \leq V_{\text{SS}} \leq -0.2\text{V}$ (V _{SS} can vary as long as $(V_{\text{DD}} - V_{\text{SS}}) \leq 5.25\text{V}$). Bypass with a 0.1 μF capacitor from V _{SS} to GND as close to the device as possible.
9	—	9	H1	High Terminal 1
10	10	10	L1	Low Terminal 1
11	11	11	W1	Wiper Terminal 1
12	12	12	GND	Ground
13	13	13	DIN	Serial-Data Input. The data at DIN synchronously loads into the serial shift register on each SCLK rising edge.
16	16	16	SCLK	Serial-Clock Input. SCLK clocks in the data when $\overline{\text{CS}}$ is low.
—	4, 9	4	D.N.C	Do Not Connect. Leave unconnected for proper operation.
EP	EP	EP	Exposed Pad	Exposed Pad. Externally connect EP to V _{SS} to provide a low thermal resistance path from the IC junction to the PC board or leave unconnected.

10-Bit, Dual, Nonvolatile, Linear-Taper Digital Potentiometers

Functional Diagrams

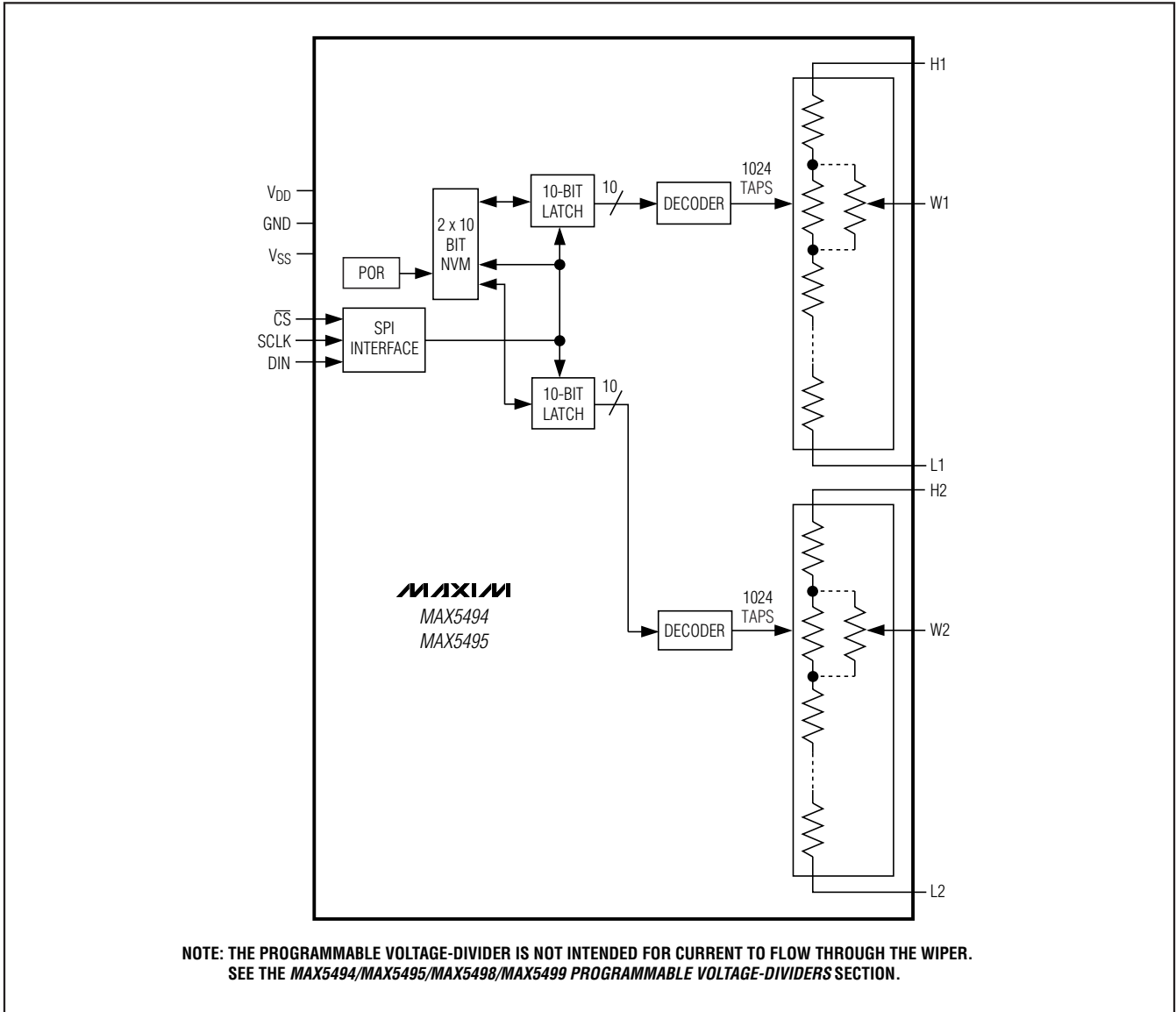

Figure 1. MAX5494/MAX5495 Functional Diagram

10-Bit, Dual, Nonvolatile, Linear-Taper Digital Potentiometers

Functional Diagrams (continued)

MAX5494-MAX5499



Figure 2. MAX5496/MAX5497 Functional Diagram



Figure 3. MAX5498/MAX5499 Functional Diagram

10-Bit, Dual, Nonvolatile, Linear-Taper Digital Potentiometers

Detailed Description

The MAX5494-MAX5499 dual, nonvolatile, linear-taper, programmable voltage-dividers and variable resistors feature 1024 tap points (10-bit resolution) (see the *Functional Diagrams*). These devices consist of multiple strings of equal resistor segments with a wiper contact that moves among the 1024 effective tap points by a 3-wire SPI-compatible serial interface. The MAX5494/MAX5496/MAX5498 provide a total 10k Ω end-to-end resistance, and the MAX5495/MAX5497/MAX5499 feature a 50k Ω end-to-end resistance. The MAX5494/MAX5495/MAX5498/MAX5499 allow access to the high, low, and wiper terminals for a standard voltage-divider configuration. Ensure that the terminal voltages fall between V_{SS} and V_{DD} .

MAX5494/MAX5495/MAX5498/MAX5499 Programmable Voltage-Dividers

The MAX5494/MAX5495/MAX5498/MAX5499 programmable voltage-dividers provide a weighted average of the voltage between the H₋ and L₋ inputs at the W₋ output.

The MAX5494/MAX5495/MAX5498/MAX5499 programmable voltage-divider network provides up to 1024 division ratios between the H₋ and L₋ voltage. Ideally, the V_L voltage occurs at the wiper terminal when all data bits are zeros and the V_H voltage occurs at the wiper terminal when all data bits are one (see the wiper voltage equation). The step-size voltage (1 LSB) is equal to the voltage applied across terminals H and L divided by 2¹⁰. Calculate the wiper voltage V_W as follows:

$$D \left[\frac{V_{HL} - (|V_{FSE}| + |V_{ZSE}|)}{1023} \right] + V_L + |V_{ZSE}|$$

where D is the decimal equivalent of the 10 data bits written (0 to 1023), V_{HL} is the voltage difference between the H₋ and L₋ terminals, and:

$$V_{FSE} = FSE \left[\frac{V_{HL}}{1024} \right]$$

$$V_{ZSE} = ZSE \left[\frac{V_{HL}}{1024} \right]$$

The MAX5494/MAX5498 provide a 10k Ω end-to-end resistance value, while the MAX5495/MAX5499 feature a 50k Ω end-to-end resistance value. **Note that the programmable voltage-divider is not intended to be used as a variable resistor.** Wiper current creates a nonlinear voltage drop in series with the wiper. To ensure temperature drift remains within specifications, do not pull current through the voltage-divider wiper. Connect the wiper to a high-impedance node. Figures 4 and 5 show the behavior of the programmable voltage-divider resistance from W₋ to H₋ and W₋ to L₋, respectively. This does not apply to the variable-resistor devices.

MAX5496-MAX5499 Variable Resistors

The MAX5496-MAX5499 provide a programmable resistance from W₋ to L₋. The MAX5496/MAX5498 provide a 10k Ω end-to-end resistance value, while the MAX5497/MAX5499 feature a 50k Ω end-to-end resistance value. The programmable resolution of this



Figure 4. Resistance from W₋ to H₋ vs. Code (10k Ω Voltage-Divider)



Figure 5. Resistance from W₋ to L₋ vs. Code (10k Ω Voltage-Divider)

10-Bit, Dual, Nonvolatile, Linear-Taper Digital Potentiometers

resistance is equal to the nominal end-to-end resistance divided by 1024 (10-bit resolution). For example, the programmable resolution is 9.8Ω and 48.8Ω for the MAX5496/MAX5498 and the MAX5497/MAX5499, respectively.

The 10-bit data in the 10-bit latch register selects the wiper position from the 1024 possible positions, resulting in 1024 values for the resistance from W₋ to L₋. Calculate the resistance from W₋ to L₋ (R_{WL}) from the formula below:

$$R_{WL}(D) = \frac{D}{1023} \times R_{W-L} + R_Z$$

where D is decimal equivalent of the 10 data bits written, R_{W-L} is the nominal end-to-end resistance, and R_Z is the zero-scale error. Table 1 shows R_{WL} at selected codes.

SPI-Compatible Serial Interface

The MAX5494-MAX5499 use a 3-wire, SPI-compatible, serial data interface (Figure 6). This write-only interface contains three inputs: chip-select (\overline{CS}), data input (DIN), and data clock (SCLK). Drive \overline{CS} low to enable the serial interface and clock data synchronously into the shift register on each SCLK rising edge.

The WRITE commands (C1, C0 = 00 or 01) require 24 clock cycles to transfer the command and data (Figure 7a). The COPY commands (C1, C0 = 10 or 11) use

either eight clock cycles to transfer the command bits (Figure 7b) or 24 clock cycles with 16 bits disregarded by the device (Figure 7a).

After the loading of data into the shift register, drive \overline{CS} high to latch the data into the appropriate control register (specified by RA1 and RA0) and disable the serial interface. Keep \overline{CS} low during the entire serial data stream to avoid corruption of the data. Table 2 shows the register map.

Write Wiper Register

The “write wiper register” command (C1, C0 = 00) controls the wiper positions. The 10 data bits (D9–D0) indicate the position of the wiper. For example, if DIN = 000000 0000, the wiper moves to the position closest to L₋. If DIN = 11 1111 1111, the wiper moves closest to H₋.

Table 1. R_{WL} at Selected Codes

CODE (DECIMAL)	END-TO-END RESISTANCE VALUE	
	10kΩ	50kΩ
	R _{WL} (Ω)	R _{WL} (Ω)
0	70	110
1	80	160
512	5,070	25,110
1023	10,070	50,110



Figure 6. SPI-Interface Timing Diagram

10-Bit, Dual, Nonvolatile, Linear-Taper Digital Potentiometers



Figure 7. SPI-Compatible Serial-Interface Format

Table 2. Register Map*

CLOCK EDGE	1	2	3	4	5	6	7	8	9	10	11	12	13	14	15	16	17	18	...	24
Bit Name	—	—	C1	C0	—	—	RA1	RA0	D9	D8	D7	D6	D5	D4	D3	D2	D1	D0	—	—
Write Wiper Register 1	0	0	0	0	0	0	0	1	D9	D8	D7	D6	D5	D4	D3	D2	D1	D0	—	—
Write Wiper Register 2	0	0	0	0	0	0	1	0	D9	D8	D7	D6	D5	D4	D3	D2	D1	D0	—	—
Write NV Register 1	0	0	0	1	0	0	0	1	D9	D8	D7	D6	D5	D4	D3	D2	D1	D0	—	—
Write NV Register 2	0	0	0	1	0	0	1	0	D9	D8	D7	D6	D5	D4	D3	D2	D1	D0	—	—
Copy Wiper Register 1 to NV Register 1	0	0	1	0	0	0	0	1	—	—	—	—	—	—	—	—	—	—	—	—
Copy Wiper Register 2 to NV Register 2	0	0	1	0	0	0	1	0	—	—	—	—	—	—	—	—	—	—	—	—
Copy Wiper Register 1 to NV Register 1 and Copy Wiper Register 2 to NV Register 2 Simultaneously	0	0	1	0	0	0	1	1	—	—	—	—	—	—	—	—	—	—	—	—
Copy NV Register 1 to Wiper Register 1	0	0	1	1	0	0	0	1	—	—	—	—	—	—	—	—	—	—	—	—
Copy NV Register 2 to Wiper Register 2	0	0	1	1	0	0	1	0	—	—	—	—	—	—	—	—	—	—	—	—
Copy NV Register 1 to Wiper Register 1 and Copy NV Register 2 to Wiper Register 2 Simultaneously	0	0	1	1	0	0	1	1	—	—	—	—	—	—	—	—	—	—	—	—

*D9 is the MSB and D0 is the LSB of the data bits.

10-Bit, Dual, Nonvolatile, Linear-Taper Digital Potentiometers

The “write wiper register” command writes data to the volatile random access memory (RAM), leaving the NV registers unchanged. When the device powers up, the data stored in the NV registers transfers to the wiper register, moving the wiper to the stored position. Figure 8 shows how to write data to wiper register 1.

Write NV Register

The “write NV register” command (C1, C0 = 01) stores the position of the wiper to the NV registers for use at power-up. Alternatively, the “copy wiper register to NV register” command writes to the NV register. Writing to

the NV register does not affect the position of the wipers. The operation takes up to 12ms (max) after \overline{CS} goes high to complete and no other operation should be performed until completion. Figure 9 shows how to write data to the NV register 1.

Copy Wiper Register to NV Register

The “copy wiper register to NV register” command (C1, C0 = 10) stores the current position of the wiper to the NV register for use at power-up. Figure 10 shows how to copy data from wiper register 1 to NV register 1.



Figure 8. Write Wiper Register 1

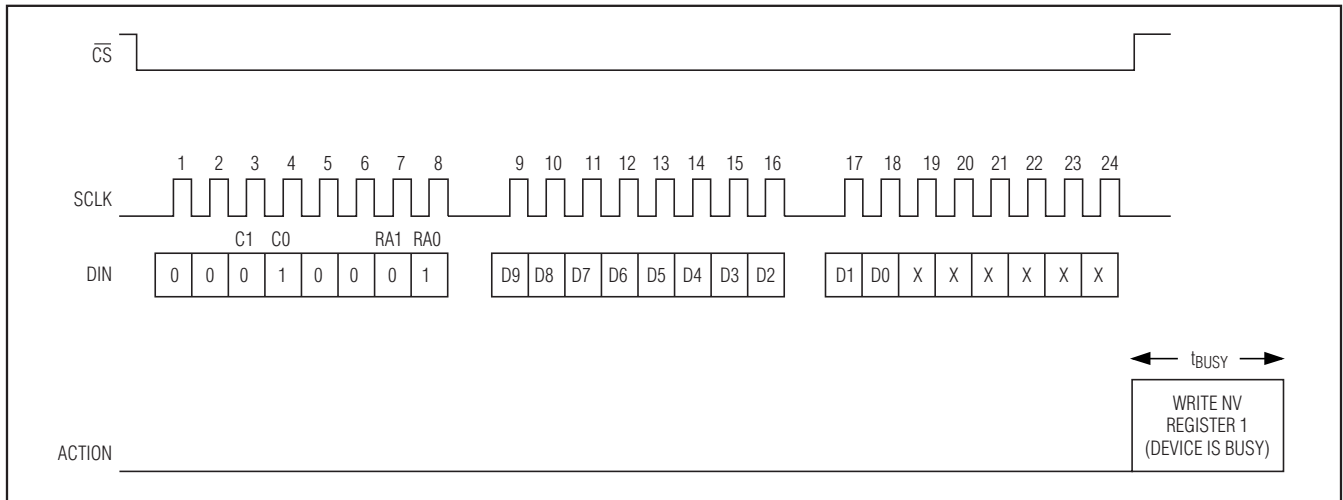

Figure 9. Write NV Register 1

10-Bit, Dual, Nonvolatile, Linear-Taper Digital Potentiometers

Copy NV Register to Wiper Register

The “copy NV register to wiper register” (C1, C0 = 11) restores the wiper position to the current value stored in the NV register. Figure 11 shows how to copy data from NV register 1 to wiper register 1.

Standby Mode

The MAX5494–MAX5499 feature a low-power standby mode. When the device is not being programmed, it enters into standby mode and supply current drops to 0.6µA (typ).

Nonvolatile Memory

The internal EEPROM consists of a nonvolatile register that retains the last value stored prior to power-down. The nonvolatile register is programmed to midscale at

the factory. The nonvolatile memory is guaranteed for 50 years for wiper data retention and up to 200,000 wiper write cycles.

Power-Up

Upon power-up, the MAX5494–MAX5499 load the data stored in the nonvolatile wiper register into the wiper register, updating the wiper position with the data stored in the nonvolatile wiper register.

Applications Information

The MAX5494–MAX5499 are intended for circuits requiring digitally controlled adjustable resistance, such as LCD contrast control (where voltage biasing adjusts the display contrast), or programmable filters with adjustable gain and/or cutoff frequency.



Figure 10. Copy Wiper Register 1 to NV Register 1

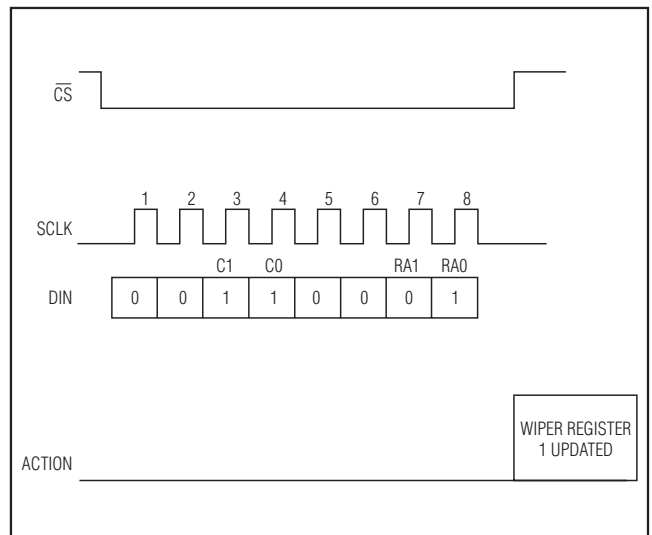

Figure 11. Copy NV Register 1 to Wiper Register 1

10-Bit, Dual, Nonvolatile, Linear-Taper Digital Potentiometers

Positive LCD Bias Control

Figures 12 and 13 show an application where the voltage-divider or variable resistor is used to make an adjustable, positive LCD-bias voltage. The op amp provides buffering and gain to the resistor-divider network.

Programmable Filter

Figure 14 shows the configuration for a 1st-order programmable filter. The gain of the filter is adjusted by R2, and the cutoff frequency is adjusted by R3. Use the following equations to calculate the gain (G) and the 3dB cutoff frequency (f_c).

$$G = 1 + \frac{R1}{R2}$$

$$f_c = \frac{1}{2\pi \times R3 \times C}$$

Gain and Offset Voltage Adjustment

Figure 15 shows an application using the MAX5498/ MAX5499 to adjust the gain and nullify the offset voltage.



Figure 12. Positive LCD Bias Control Using a Voltage-Divider

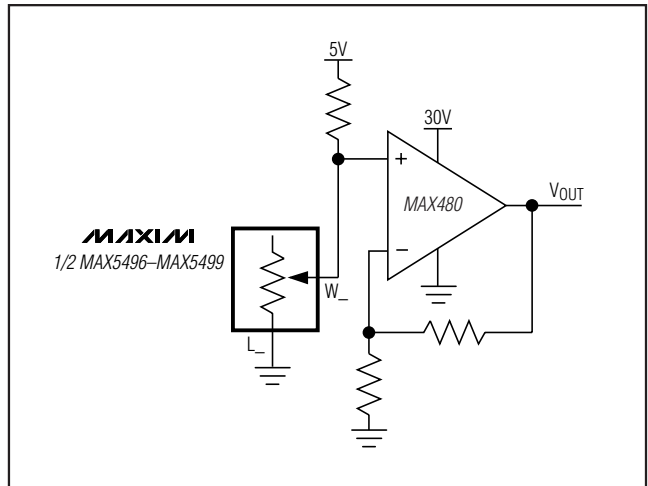

Figure 13. Positive LCD Bias Control Using a Variable Resistor



Figure 14. Programmable Filter



Figure 15. Gain- and Offset-Voltage Adjustment Circuit

10-Bit, Dual, Nonvolatile, Linear-Taper Digital Potentiometers

Selector Guide

PART	CONFIGURATION	END-TO-END RESISTANCE (kΩ)
MAX5494ETE	Two programmable voltage-dividers	10
MAX5495ETE	Two programmable voltage-dividers	50
MAX5496ETE	Two variable resistors	10
MAX5497ETE	Two variable resistors	50
MAX5498ETE	One programmable voltage-diver and one variable resistor	10
MAX5499ETE	One programmable voltage-diver and one variable resistor	50

Ordering Information (continued)

PART	TEMP RANGE	PIN-PACKAGE	PKG CODE
MAX5496ETE	-40°C to +85°C	16 TQFN-EP*	T1655-2
MAX5497ETE	-40°C to +85°C	16 TQFN-EP*	T1655-2
MAX5498ETE	-40°C to +85°C	16 TQFN-EP*	T1655-2
MAX5499ETE	-40°C to +85°C	16 TQFN-EP*	T1655-2

*EP = Exposed pad.

Chip Information

TRANSISTOR COUNT: 32,262

PROCESS: BiCMOS

Pin Configurations (continued)



10-Bit, Dual, Nonvolatile, Linear-Taper Digital Potentiometers

Package Information

(The package drawing(s) in this data sheet may not reflect the most current specifications. For the latest package outline information go to www.maxim-ic.com/packages.)

MAX5494-MAX5499



10-Bit, Dual, Nonvolatile, Linear-Taper Digital Potentiometers

Package Information (continued)

(The package drawing(s) in this data sheet may not reflect the most current specifications. For the latest package outline information go to www.maxim-ic.com/packages.)

COMMON DIMENSIONS															
PKG.	16L 5x5			20L 5x5			28L 5x5			32L 5x5			40L 5x5		
SYMBOL	MIN.	NOM.	MAX.	MIN.	NOM.	MAX.	MIN.	NOM.	MAX.	MIN.	NOM.	MAX.	MIN.	NOM.	MAX.
A	0.70	0.75	0.80	0.70	0.75	0.80	0.70	0.75	0.80	0.70	0.75	0.80	0.70	0.75	0.80
AI	0	0.02	0.05	0	0.02	0.05	0	0.02	0.05	0	0.02	0.05	0	0.02	0.05
A2	0.20 REF.			0.20 REF.			0.20 REF.			0.20 REF.			0.20 REF.		
b	0.25	0.30	0.35	0.25	0.30	0.35	0.20	0.25	0.30	0.20	0.25	0.30	0.15	0.20	0.25
D	4.90	5.00	5.10	4.90	5.00	5.10	4.90	5.00	5.10	4.90	5.00	5.10	4.90	5.00	5.10
E	4.90	5.00	5.10	4.90	5.00	5.10	4.90	5.00	5.10	4.90	5.00	5.10	4.90	5.00	5.10
e	0.60 BSC.			0.65 BSC.			0.50 BSC.			0.50 BSC.			0.40 BSC.		
k	0.25	-	-	0.25	-	-	0.25	-	-	0.25	-	-	0.25	-	-
L	0.30	0.40	0.50	0.45	0.55	0.65	0.45	0.55	0.65	0.30	0.40	0.50	0.30	0.40	0.50
N	16			20			28			32			40		
ND	4			5			7			8			10		
NE	4			5			7			8			10		
JEDEC	WHHB			WHHC			WHHD-1			WHHD-2			-----		

NOTES:

- DIMENSIONING & TOLERANCING CONFORM TO ASME Y14.5M-1994.
- ALL DIMENSIONS ARE IN MILLIMETERS. ANGLES ARE IN DEGREES.
- N IS THE TOTAL NUMBER OF TERMINALS.
- THE TERMINAL #1 IDENTIFIER AND TERMINAL NUMBERING CONVENTION SHALL CONFORM TO JEDEC 95-1 SPP-012. DETAILS OF TERMINAL #1 IDENTIFIER ARE OPTIONAL, BUT MUST BE LOCATED WITHIN THE ZONE INDICATED. THE TERMINAL #1 IDENTIFIER MAY BE EITHER A MOLD OR MARKED FEATURE.
- DIMENSION b APPLIES TO METALLIZED TERMINAL AND IS MEASURED BETWEEN 0.25 mm AND 0.30 mm FROM TERMINAL TIP.
- ND AND NE REFER TO THE NUMBER OF TERMINALS ON EACH D AND E SIDE RESPECTIVELY.
- DEPOPULATION IS POSSIBLE IN A SYMMETRICAL FASHION.
- COPLANARITY APPLIES TO THE EXPOSED HEAT SINK SLUG AS WELL AS THE TERMINALS.
- DRAWING CONFORMS TO JEDEC MO220, EXCEPT EXPOSED PAD DIMENSION FOR T2855-3, T2855-6, T4055-1 AND T4055-2.
- WARPAGE SHALL NOT EXCEED 0.10 mm.
- MARKING IS FOR PACKAGE ORIENTATION REFERENCE ONLY.
- NUMBER OF LEADS SHOWN ARE FOR REFERENCE ONLY.
- LEAD CENTERLINES TO BE AT TRUE POSITION AS DEFINED BY BASIC DIMENSION 'e', ±0.05.
- ALL DIMENSIONS APPLY TO BOTH LEADED AND P&F PARTS.

-DRAWING NOT TO SCALE-

EXPOSED PAD VARIATIONS						
PKG. CODES	D2			E2		
	MIN.	NOM.	MAX.	MIN.	NOM.	MAX.
T1655-2	3.00	3.10	3.20	3.00	3.10	3.20
T1655-3	3.00	3.10	3.20	3.00	3.10	3.20
T1655N-1	3.00	3.10	3.20	3.00	3.10	3.20
T2055-3	3.00	3.10	3.20	3.00	3.10	3.20
T2055-4	3.00	3.10	3.20	3.00	3.10	3.20
T2055-5	3.15	3.25	3.35	3.15	3.25	3.35
T2055MN-5	3.15	3.25	3.35	3.15	3.25	3.35
T2855-3	3.15	3.25	3.35	3.15	3.25	3.35
T2855-4	2.60	2.70	2.80	2.60	2.70	2.80
T2855-5	2.60	2.70	2.80	2.60	2.70	2.80
T2855-6	3.15	3.25	3.35	3.15	3.25	3.35
T2855-7	2.60	2.70	2.80	2.60	2.70	2.80
T2855-8	3.15	3.25	3.35	3.15	3.25	3.35
T2855N-1	3.15	3.25	3.35	3.15	3.25	3.35
T3255-3	3.00	3.10	3.20	3.00	3.10	3.20
T3255-4	3.00	3.10	3.20	3.00	3.10	3.20
T3255M-4	3.00	3.10	3.20	3.00	3.10	3.20
T3255-5	3.00	3.10	3.20	3.00	3.10	3.20
T3255N-1	3.00	3.10	3.20	3.00	3.10	3.20
T4055-1	3.40	3.50	3.60	3.40	3.50	3.60
T4055-2	3.40	3.50	3.60	3.40	3.50	3.60
T4055MN-1	3.40	3.50	3.60	3.40	3.50	3.60



TITLE: PACKAGE OUTLINE, 16,20,28,32,40L THIN QFN, 5x5x0.80mm		
APPROVAL	DOCUMENT CONTROL NO. 21-0140	REV. L 2/2

Maxim cannot assume responsibility for use of any circuitry other than circuitry entirely embodied in a Maxim product. No circuit patent licenses are implied. Maxim reserves the right to change the circuitry and specifications without notice at any time.

20 **Maxim Integrated Products, 120 San Gabriel Drive, Sunnyvale, CA 94086 408-737-7600**



Компания «ЭлектроПласт» предлагает заключение долгосрочных отношений при поставках импортных электронных компонентов на взаимовыгодных условиях!

Наши преимущества:

- Оперативные поставки широкого спектра электронных компонентов отечественного и импортного производства напрямую от производителей и с крупнейших мировых складов;
- Поставка более 17-ти миллионов наименований электронных компонентов;
- Поставка сложных, дефицитных, либо снятых с производства позиций;
- Оперативные сроки поставки под заказ (от 5 рабочих дней);
- Экспресс доставка в любую точку России;
- Техническая поддержка проекта, помощь в подборе аналогов, поставка прототипов;
- Система менеджмента качества сертифицирована по Международному стандарту ISO 9001;
- Лицензия ФСБ на осуществление работ с использованием сведений, составляющих государственную тайну;
- Поставка специализированных компонентов (Xilinx, Altera, Analog Devices, Intersil, Interpoint, Microsemi, Aeroflex, Peregrine, Syfer, Eurofarad, Texas Instrument, Miteq, Cobham, E2V, MA-COM, Hittite, Mini-Circuits, General Dynamics и др.);

Помимо этого, одним из направлений компании «ЭлектроПласт» является направление «Источники питания». Мы предлагаем Вам помощь Конструкторского отдела:

- Подбор оптимального решения, техническое обоснование при выборе компонента;
- Подбор аналогов;
- Консультации по применению компонента;
- Поставка образцов и прототипов;
- Техническая поддержка проекта;
- Защита от снятия компонента с производства.



Как с нами связаться

Телефон: 8 (812) 309 58 32 (многоканальный)

Факс: 8 (812) 320-02-42

Электронная почта: org@eplast1.ru

Адрес: 198099, г. Санкт-Петербург, ул. Калинина, дом 2, корпус 4, литера А.