

3M™ PIN STRIP HEADER, 951 SERIES
 2MM AND 2MM X 2MM STRAIGHT, RIGHT ANGLE AND SURFACE MOUNT, SOLDER TAIL

- NOTES
1. REGULATORY INFORMATION:
 VISIT 3M.com/regs OR CONTACT YOUR 3M REPRESENTATIVE TO FIND THE RoHS COMPLIANCE STATUS OF THE 3M PART YOU ARE INTERESTED IN.
 2. IN THE EVENT OF CONFLICT BETWEEN THIS DATA AND THAT CONTAINED IN THE PRODUCT SPECIFICATION, THE PRODUCT SPECIFICATION TAKES PRECEDENT.
 3. N = THE NUMBER OF POSITIONS.



SINGLE ROW STRAIGHT VERSION



DUAL ROW STRAIGHT VERSION



SINGLE ROW RIGHT ANGLE VERSION



DUAL ROW RIGHT ANGLE VERSION



SINGLE ROW SURFACE MOUNT VERSION



DUAL ROW SURFACE MOUNT VERSION

2 PHYSICAL :

INSULATOR: HIGH TEMP THERMOPLASTIC
 MATERIAL: UL94V-0
 FLAMMABILITY: BLACK
 CONTACT: BRASS
 MATERIAL: BRASS
 PLATING: 50μ" [1.27μm] NICKEL-OVERALL
 UNDER PLATING: GOLD FLASH
 WIPING AREA: 40-118μ" [1-3μm]
 SOLDER TAILS: ORIENTATION TRIANGLE

2 ELECTRICAL :

CURRENT RATING: 2A
 CONTACT RESISTANCE: ≤ 20mΩ
 INSULATION RESISTANCE: ≥ 1000MΩ
 WITHSTANDING VOLTAGE: 500V_{RMS} 1mA, 60s

2 MECHANICAL :

RETENTION FORCE: ≥ 4.5N PER PIN

2 ENVIRONMENTAL :

TEMPERATURE RATING: -55°C TO 125°C
 HUMIDITY: < 93% AT 40°C
 RESISTANCE TO SOLDERING HEAT: PBT, 245°C±5°C, 10s

3M ELECTRONICS MATERIALS SOLUTIONS DIVISION
 INTERCONNECT SOLUTIONS
<http://www.3mconnectors.com>
 3M IS A TRADEMARK OF 3M COMPANY.
 FOR TECHNICAL, SALES OR ORDERING
 INFORMATION CALL 800-225-5373

UL us
 UL FILE NO: E68080

MM [INCH]		
TOLERANCE - UNLESS NOTED		
	X.	.XX
MM	±.5	±.20
[INCH]	±.02	±.008
[] = DIM. FOR REFERENCE ONLY		

DIMENSIONS: INCH [MM]
 [MM] FOR REF. ONLY

DESIGN REFERENCE	NEXT ASSEMBLY	REV	ECO	ISSUE DATE AND DESCRIPTION	DRFT	CHKD
ACROSS CODES		CASTIGLIONE		FEB 23, 2015		
DIVISION	DIVISION CODE	DATE	APPRV	DATE		
	EMSD		T. SUNIGA	FEB 23, 2015		
DO NOT SCALE DRAWING	SCALE 4/1	TOLERANCES EXCEPT AS NOTED		© 3M COPYRIGHT 2017 This document and the information it contains are 3M property and may not be reproduced or further distributed without 3M permission, or used or disclosed other than for 3M authorized purposes. All rights reserved.		
THIRD ANGLE PROJECTION	INTERPRET PER ASME Y14.5 - 2009	TOLERANCES EXCEPT AS NOTED		TITLE PIN STRIP HEADER, 2MM X 2MM, STRAIGHT, SMT & RA, SOLDER TAIL		
MAX SURFACE ROUGHNESS	DT SURFACES	CAGE NUMBER	SIZE	DRAWING NO.	REV.	
MARKED ONLY	ANGLES	D		78-5100-2653-3	B	
		MODEL		951XXX		
		DET		ISTs	YES	NO
				SHT	1	OF 5

B 78-5100-2653-3 REV. 1
 C
 B
 A
 Drawing Number
 Drf-set
 Standard Time 11/27/2017 UTC

3M™ PIN STRIP HEADER, 951 SERIES
 2MM AND 2MM X 2MM STRAIGHT, RIGHT ANGLE AND SURFACE MOUNT, SOLDER TAIL

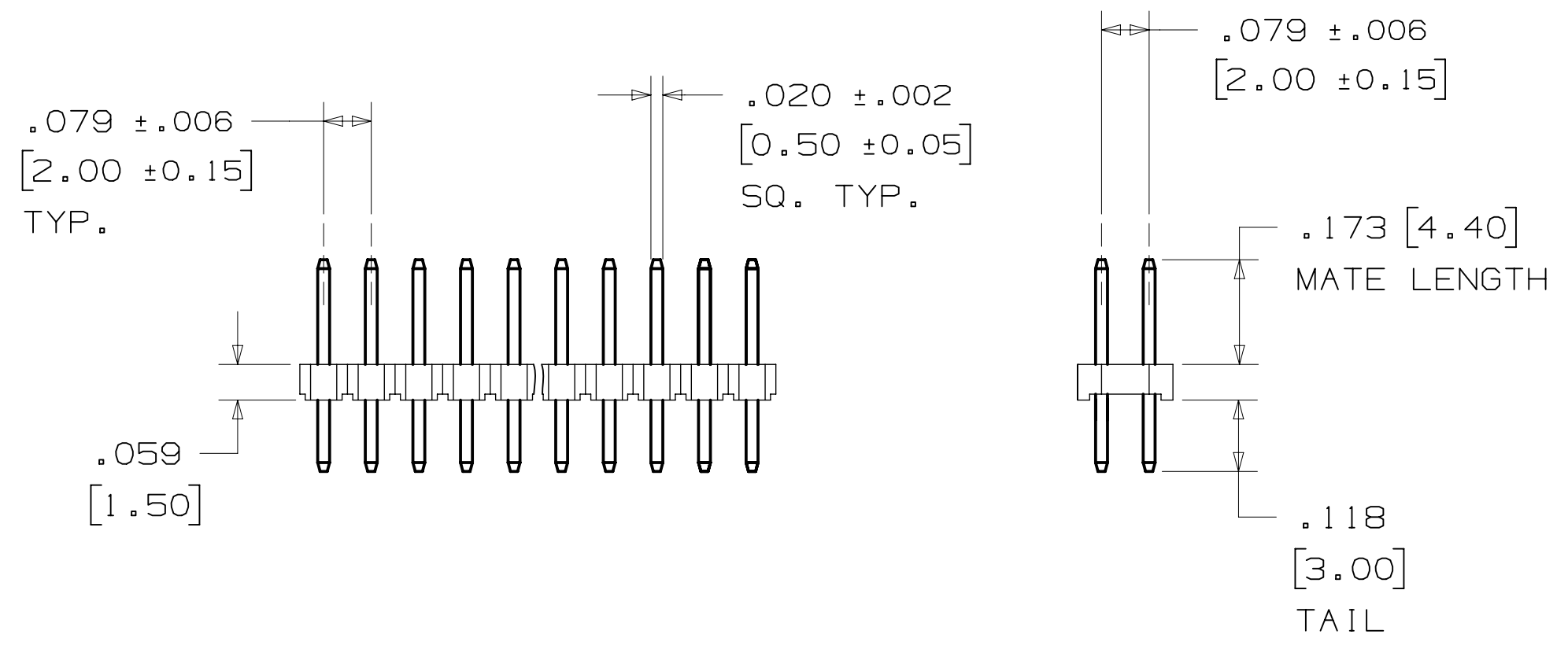

ORDERING INFORMATION
 STRAIGHT VERSION

951XXX-8622-AR

No. OF ROWS: 1 = 1 ROW
 2 = 2 ROW
 CONTACT QTY. 40 PINS = 1 ROW
 80 PINS = 2 ROW

TABLE 1	
DIM. "A"	.079 [2.00] X N
DIM. "B"	.079 [2.00] X (N-1)
DIM. "C"	.079 [2.00] X (N/2)
DIM. "D"	.079 [2.00] X (N/2-1)
SEE NOTE 3	

DESIGN REFERENCE	NEXT ASSEMBLY	REV	ECO	ISSUE DATE AND DESCRIPTION	DRFT	CHKD
APPROVED	DATE	DATE	DATE	DATE	DATE	DATE
APPROVED	DATE	APPROVED	DATE	APPROVED	DATE	APPROVED
APPROVED	DATE	APPROVED	DATE	APPROVED	DATE	APPROVED

DIVISION CODE: EMSD
 DO NOT SCALE DRAWING
 SCALE: 4/1
 TOLERANCES EXCEPT AS NOTED
 INCHES: .00, .000, .0000
 MILLIMETERS: 0, .00, .000, .0000
 INTERPRET PER ASME Y14.5 - 2009
 MAX. SURFACE ROUGHNESS: 0.40, 0.20, 0.10, 0.05
 SURFACES: 0.40, 0.20, 0.10, 0.05
 MARKED ONLY
 ANGLE: 0, 45, 90, 135, 180, 225, 270, 315

TITLE: PIN STRIP HEADER, 2MM X 2MM, STRAIGHT, SMT & RA, SOLDER TAIL
 CAGE NUMBER: D78-5100-2653-3
 MODEL: 951XXX
 REV. B
 SHEET 2 OF 5

78-5100-2653-3
 11/27/2017 UTC
 Drf-set

3M™ PIN STRIP HEADER, 951 SERIES
 2MM AND 2MM X 2MM STRAIGHT, RIGHT ANGLE AND SURFACE MOUNT, SOLDER TAIL



RECOMMENDED PC BOARD LAYOUT
 (VIEWED FROM CONNECTOR SIDE)



RECOMMENDED PC BOARD LAYOUT
 (VIEWED FROM CONNECTOR SIDE)



ORDERING INFORMATION
 RIGHT ANGLE VERSION

951XXX-7X22-AR

No. OF ROWS:
 1 = 1 ROW
 2 = 2 ROW
 CONTACT QTY:
 40 PINS = 1 ROW
 80 PINS = 2 ROW

DIM. "F" MATING PIN LENGTH:
 6 = .173 [4.40]
 7 = .295 [7.50]

TABLE 2

DIM. "A"	.079 [2.00] X N
DIM. "B"	.079 [2.00] X (N-1)
DIM. "C"	.079 [2.00] X (N/2)
DIM. "D"	.079 [2.00] X (N/2-1)
SEE NOTE 3	

DESIGN REFERENCE	NEXT ASSEMBLY	REV	ECO	ISSUE DATE AND DESCRIPTION	DRFT	CHKD
APPROVED	DATE	DATE	DATE	DATE	DATE	DATE
CHKD	DATE	DATE	DATE	DATE	DATE	DATE
DIVISION		DIVISION CODE		DATE		
		EMSD		FEB 23, 2015		
DO NOT SCALE DRAWING	SCALE	TOLERANCES EXCEPT AS NOTED		INCHES		
	4/1			.00		
				.000		
				.0000		
				MILLIMETERS		
				0		
				.00		
				.000		
				.000		
				MARKED ONLY		
				ANGLES		
3M		3M Center St. Paul, MN 55144		© 3M COPYRIGHT 2017		
3M		3M property and may not be reproduced or further distributed without 3M permission, or used or disclosed other than for 3M authorized purposes. All rights reserved.		This document and the information it contains are		
TITLE		PIN STRIP HEADER, 2MM X 2MM, STRAIGHT, SMT & RA, SOLDER TAIL				
CAGE NUMBER	SIZE	DRAWING NO.	REV.			
D		78-5100-2653-3	B			
MODEL	951XXX	DET	YES	NO	SHT 3 OF 5	

78-5100-2653-3
 DRAWING NUMBER
 B
 REV. 1
 11/27/2017
 JNC
 TS
 Drt-set
 Time 11/27/2017 UTC
 Standard
 B.2 Central

3M™ PIN STRIP HEADER, 951 SERIES
 2MM AND 2MM X 2MM STRAIGHT, RIGHT ANGLE AND SURFACE MOUNT, SOLDER TAIL

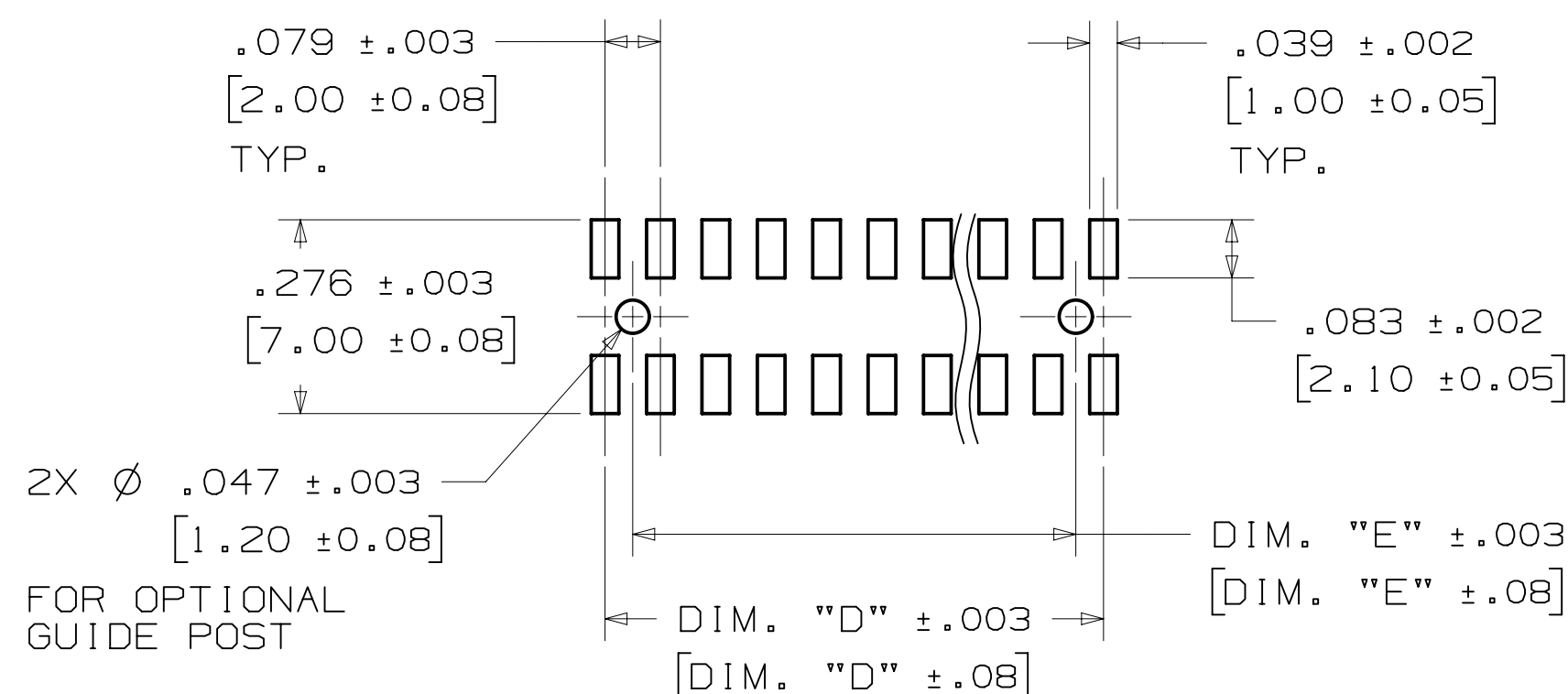
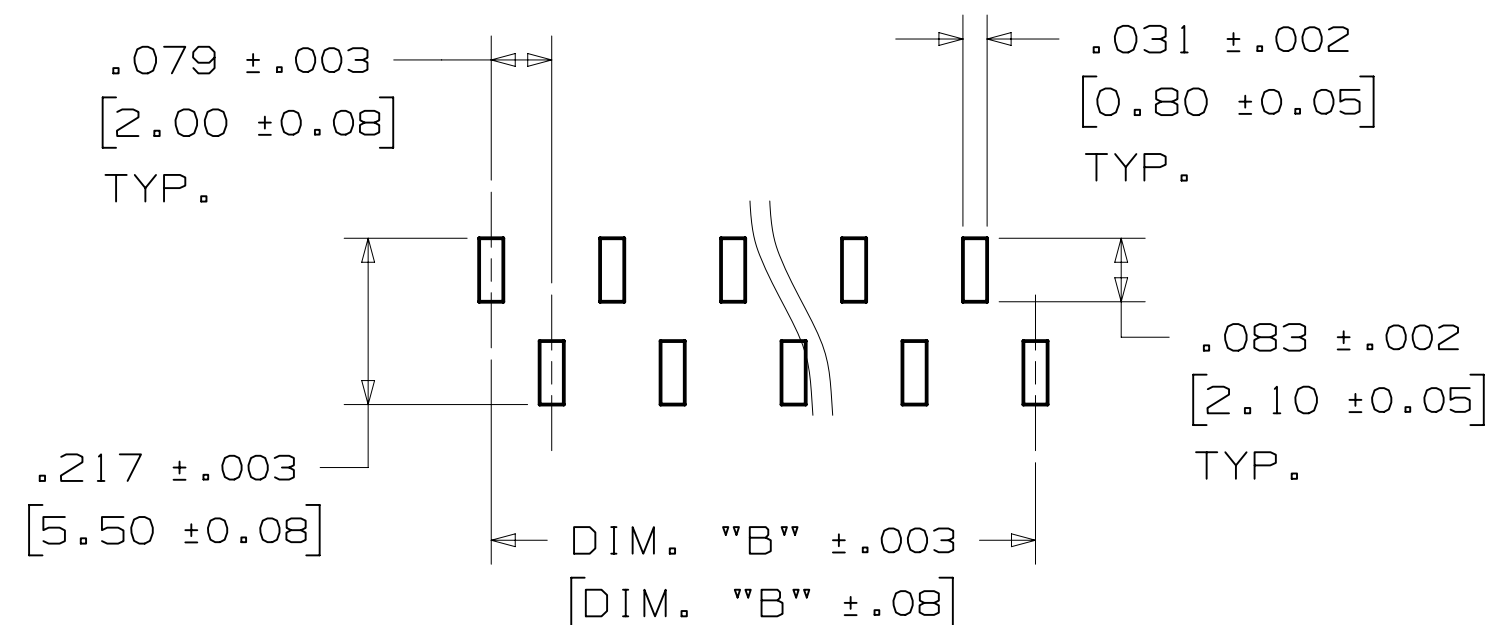
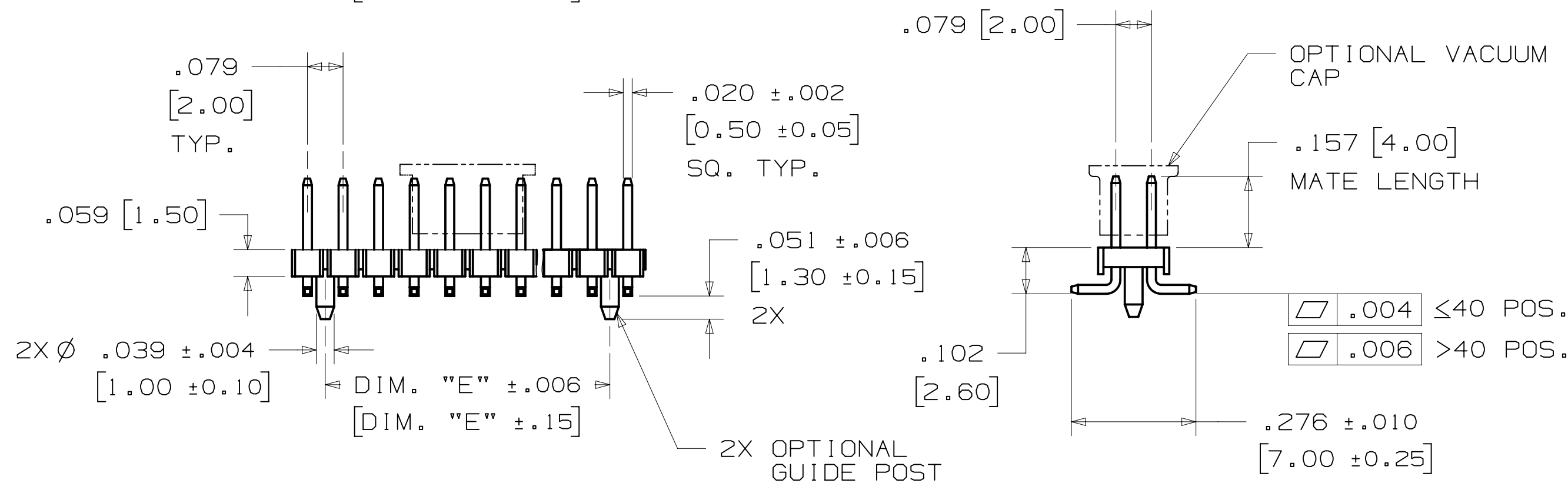
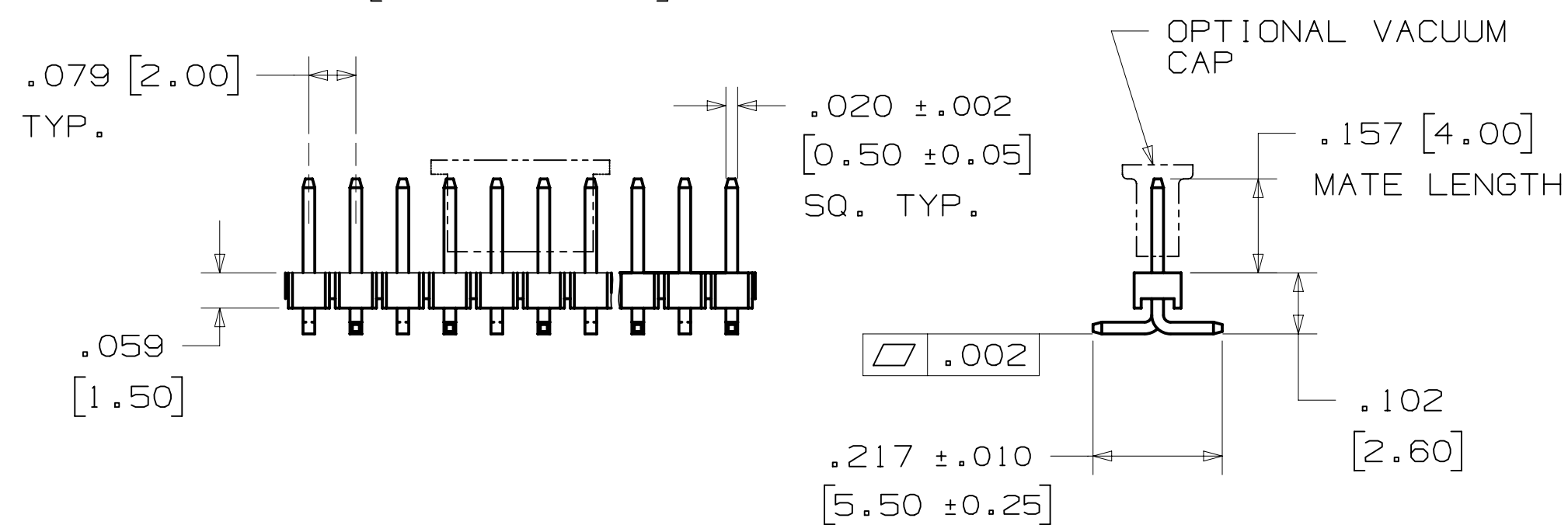
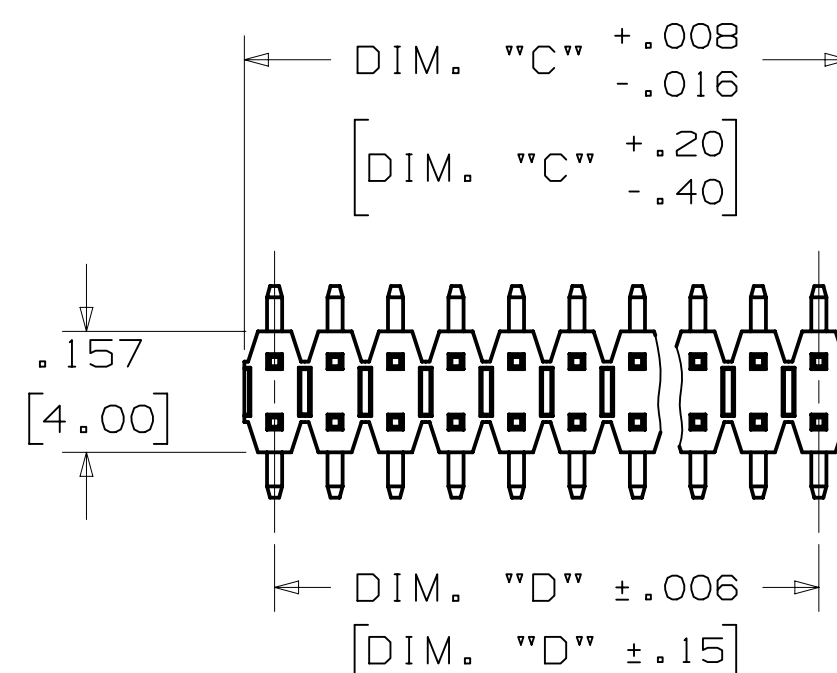
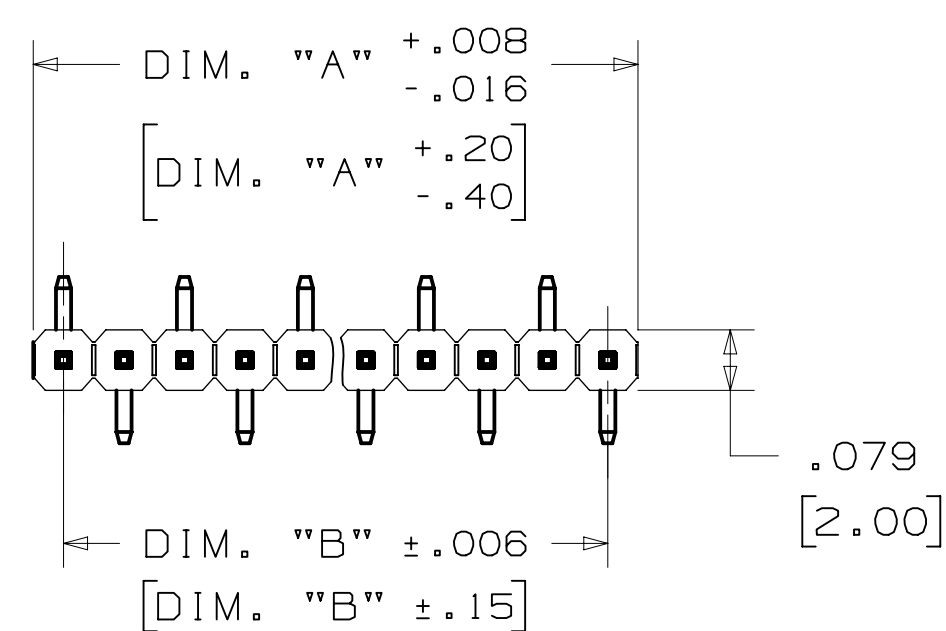

RECOMMENDED PC BOARD LAYOUT
 (VIEWED FROM CONNECTOR SIDE)

RECOMMENDED PC BOARD LAYOUT
 (VIEWED FROM CONNECTOR SIDE)

ORDERING INFORMATION
 SURFACE MOUNT VERSION

951XXX-25X0-AR-XX

No. OF ROWS:
 1 = 1 ROW
 2 = 2 ROW

CONTACT QUANTITY:
 40 PINS = 1 ROW
 80 PINS = 2 ROW

PACKAGING:
 TP = TUBE
 PT = TUBE WITH PAD
 PR = TAPE & REEL WITH PAD
 NOTE: PAD OPTIONS
 1 ROW = 40 POSITION
 2 ROW = 80 POSITION

BOARD LOCATION FEATURES:
 3 = 1 ROW / PIN 1 LEFT
 2 = 2 ROW / NONE
 5 = 2 ROW / WITH LOCATION POST
 (8 - 14 CONTACTS)

TABLE 3	
DIM. "A"	.079 [2.00] X N
DIM. "B"	.079 [2.00] X (N-1)
DIM. "C"	.079 [2.00] X (N/2)
DIM. "D"	.079 [2.00] X (N/2-1)
DIM. "E"	.079 [2.00] X (N/2-2)
SEE NOTE 3	

TAPE & REEL OPTION		
1 ROW	CONTACT QTY.	40
2 ROW		80
TAPE WIDTH [MM]		104

REV	ECO	ISSUE DATE AND DESCRIPTION	DRFT	CHKD
B	76546	NOV 08, 2017 REVISE SHT 4	JNC	SC
A	72044	MAR 06, 2017 REVISE ELECTRICAL NOTES 3-2-17 REMOVED 2 CONNECTORS PRODUCTION RELEASE	JNC	TS

DESIGN REFERENCE	NEXT ASSEMBLY	REV	ECO	ISSUE DATE AND DESCRIPTION	DRFT	CHKD
				FEB 23, 2015		
DIVISION		DIVISION CODE		DATE		
DO NOT SCALE DRAWING		SCALE 4/1		TOLERANCES EXCEPT AS NOTED		
THIRD ANGLE PROJECTION		INCHES		MILLIMETERS		
MAX SURFACE ROUGHNESS		SURFACES		MARKED ONLY		
CAGE NUMBER		DRAWING NO.		REV.		
D 78-5100-2653-3		B		SHT 4 OF 5		

Imaged: B.2 Central Standard Time 11/27/2017 UTC Drr-set

3M™ PIN STRIP HEADER, 951 SERIES
 2MM AND 2MM X 2MM STRAIGHT, RIGHT ANGLE AND SURFACE MOUNT, SOLDER TAIL

Regulatory: For regulatory information about this product, visit 3M.com/regs or contact your 3M representative.

Technical Information: The technical information, recommendations and other statements contained in this document are based upon tests or experience that 3M believes are reliable, but the accuracy or completeness of such information is not guaranteed.

Product Use: Many factors beyond 3M's control and uniquely within user's control can affect the use and performance of a 3M product in a particular application. Given the variety of factors that can affect the use and performance of a 3M product, user is solely responsible for evaluating the 3M product and determining whether it is fit for a particular purpose and suitable for user's method of application.

Warranty, Limited Remedy, and Disclaimer: Unless an additional warranty is specifically stated on the applicable 3M product packaging or product literature, 3M warrants that each 3M product meets the applicable 3M product specification at the time 3M ships the product. 3M MAKES NO OTHER WARRANTIES OR CONDITIONS, EXPRESS OR IMPLIED, INCLUDING, BUT NOT LIMITED TO, ANY IMPLIED WARRANTY OR CONDITION OF MERCHANTABILITY OR FITNESS FOR A PARTICULAR PURPOSE OR ANY IMPLIED WARRANTY OR CONDITION ARISING OUT OF A COURSE OF DEALING, CUSTOM OR USAGE OR TRADE. If the 3M product does not conform to this warranty, then the sole and exclusive remedy is, at 3M's option, replacement of the 3M product or refund of the purchase price.

Limitation of Liability: Except where prohibited by law, 3M will not be liable for any loss or damage arising from the 3M product, whether direct, indirect, special, incidental or consequential, regardless of the legal theory asserted, including warranty, contract, negligence or strict liability.

3M Electronics Materials Solutions Division
 6801 River Place Blvd.
 Austin, TX 78726-9000
 1-800-225-5373
www.3M.com/interconnect

DESIGN REFERENCE	NEXT ASSEMBLY	REV	ECO	ISSUE DATE AND DESCRIPTION	DRFT	CHKD
APPROVED	DATE	DATE	DATE	DATE	DATE	DATE
CASTIGLIONE	FEB 23, 2015	FEB 23, 2015	T. SUNIGA	FEB 23, 2015		
DIVISION	DIVISION CODE	 3M Center St. Paul, MN 55144 © 3M COPYRIGHT 2017 This document and the information it contains are 3M property and may not be reproduced or further distributed without 3M permission, or used or disclosed other than for 3M authorized purposes. All rights reserved.				
DO NOT SCALE DRAWING	SCALE 4/1	TOLERANCES EXCEPT AS NOTED		TITLE		
		INCHES		PIN STRIP HEADER, 2MM X 2MM, STRAIGHT, SMT & RA, SOLDER TAIL		
THIRD ANGLE PROJECTION	INTERPRET PER ASME Y14.5 - 2009	MILLIMETERS		CAGE NUMBER	SIZE	DRAWING NO.
				D	78-5100-2653-3	B
MAX SURFACE ROUGHNESS	MARKED ONLY	ANGLES		MODEL	951XXX	REV. 5 OF 5
				DET	YES	NO

78-5100-2653-3
 DRAWING NUMBER
 B
 REVISION
 01/27/2017
 Standard Time
 B.2 Central
 Drf-set



Компания «ЭлектроПласт» предлагает заключение долгосрочных отношений при поставках импортных электронных компонентов на взаимовыгодных условиях!

Наши преимущества:

- Оперативные поставки широкого спектра электронных компонентов отечественного и импортного производства напрямую от производителей и с крупнейших мировых складов;
- Поставка более 17-ти миллионов наименований электронных компонентов;
- Поставка сложных, дефицитных, либо снятых с производства позиций;
- Оперативные сроки поставки под заказ (от 5 рабочих дней);
- Экспресс доставка в любую точку России;
- Техническая поддержка проекта, помощь в подборе аналогов, поставка прототипов;
- Система менеджмента качества сертифицирована по Международному стандарту ISO 9001;
- Лицензия ФСБ на осуществление работ с использованием сведений, составляющих государственную тайну;
- Поставка специализированных компонентов (Xilinx, Altera, Analog Devices, Intersil, Interpoint, Microsemi, Aeroflex, Peregrine, Syfer, Eurofarad, Texas Instrument, Miteq, Cobham, E2V, MA-COM, Hittite, Mini-Circuits, General Dynamics и др.);

Помимо этого, одним из направлений компании «ЭлектроПласт» является направление «Источники питания». Мы предлагаем Вам помощь Конструкторского отдела:

- Подбор оптимального решения, техническое обоснование при выборе компонента;
- Подбор аналогов;
- Консультации по применению компонента;
- Поставка образцов и прототипов;
- Техническая поддержка проекта;
- Защита от снятия компонента с производства.



Как с нами связаться

Телефон: 8 (812) 309 58 32 (многоканальный)

Факс: 8 (812) 320-02-42

Электронная почта: org@eplast1.ru

Адрес: 198099, г. Санкт-Петербург, ул. Калинина, дом 2, корпус 4, литера А.