

3M™ PIN STRIP HEADER, 951 SERIES
 2MM AND 2MM X 2MM STRAIGHT, RIGHT ANGLE AND SURFACE MOUNT, SOLDER TAIL

- NOTES
1. REGULATORY INFORMATION:
 VISIT 3M.com/regs OR CONTACT YOUR 3M REPRESENTATIVE TO FIND THE RoHS COMPLIANCE STATUS OF THE 3M PART YOU ARE INTERESTED IN.
 2. IN THE EVENT OF CONFLICT BETWEEN THIS DATA AND THAT CONTAINED IN THE PRODUCT SPECIFICATION, THE PRODUCT SPECIFICATION TAKES PRECEDENT.
 3. N = THE NUMBER OF POSITIONS.



SINGLE ROW STRAIGHT VERSION



DUAL ROW STRAIGHT VERSION



SINGLE ROW RIGHT ANGLE VERSION



DUAL ROW RIGHT ANGLE VERSION



SINGLE ROW SURFACE MOUNT VERSION



DUAL ROW SURFACE MOUNT VERSION

2 PHYSICAL :

INSULATOR: HIGH TEMP THERMOPLASTIC
 MATERIAL: UL94V-0
 FLAMMABILITY: BLACK
 CONTACT: BRASS
 MATERIAL: BRASS
 PLATING: 50μ" [1.27μm] NICKEL-OVERALL
 UNDER PLATING: GOLD FLASH
 WIPING AREA: 40-118μ" [1-3μm]
 SOLDER TAILS: ORIENTATION TRIANGLE

2 ELECTRICAL :

CURRENT RATING: 2A
 CONTACT RESISTANCE: ≤ 20mΩ
 INSULATION RESISTANCE: ≥ 1000MΩ
 WITHSTANDING VOLTAGE: 500V_{RMS} 1mA, 60s

2 MECHANICAL :

RETENTION FORCE: ≥ 4.5N PER PIN

2 ENVIRONMENTAL :

TEMPERATURE RATING: -55°C TO 125°C
 HUMIDITY: < 93% AT 40°C
 RESISTANCE TO SOLDERING HEAT: PBT, 245°C±5°C, 10s

3M ELECTRONICS MATERIALS SOLUTIONS DIVISION
 INTERCONNECT SOLUTIONS
<http://www.3mconnectors.com>
 3M IS A TRADEMARK OF 3M COMPANY.
 FOR TECHNICAL, SALES OR ORDERING
 INFORMATION CALL 800-225-5373

UL us
 UL FILE NO: E68080

MM [INCH]		
TOLERANCE - UNLESS NOTED		
	X.	.XX
MM	±.5	±.20
[INCH]	±.02	±.008
[] = DIM. FOR REFERENCE ONLY		

DIMENSIONS: INCH [MM]
 [MM] FOR REF. ONLY

DESIGN REFERENCE	NEXT ASSEMBLY	REV	ECO	ISSUE DATE AND DESCRIPTION	DRFT	CHKD
APPROVED	DATE	APPROVED	DATE	DATE		
CASTIGLIONE	FEB 23, 2015	T. SUNIGA	FEB 23, 2015	FEB 23, 2015		
DIVISION		DIVISION CODE		MFG		
DO NOT SCALE DRAWING		SCALE 4/1		TOLERANCES EXCEPT AS NOTED		
THIRD ANGLE PROJECTION		INCHES		MILLIMETERS		
INTERPRET PER ASME Y14.5 - 2009		0 ±		0 ±		
MAX SURFACE ROUGHNESS		0 ±		0 ±		
UNFINISHED SURFACES		0 ±		0 ±		
MARKED ONLY		0 ±		0 ±		
ANGLES		0 ±		0 ±		
TITLE		CAGE NUMBER		DRAWING NO.		REV.
PIN STRIP HEADER, 2MM X 2MM, STRAIGHT, SMT & RA, SOLDER TAIL		D 78-5100-2653-3		B		B
MODEL		951XXX		SHT 1 OF 5		

B	76546	NOV 08, 2017	JNC	SC
		REVISE SHT 4		
A	72044	MAR 06, 2017	JNC	TS
		REVISE ELECTRICAL NOTES		
		3-2-17 REMOVED 2 CONNECTORS		
		PRODUCTION RELEASE		

B REVISION
 78-5100-2653-3 DRAWING NUMBER
 B
 Drr.set
 A
 Standard Time 11/27/2017 UTC

3M™ PIN STRIP HEADER, 951 SERIES

2MM AND 2MM X 2MM STRAIGHT, RIGHT ANGLE AND SURFACE MOUNT, SOLDER TAIL

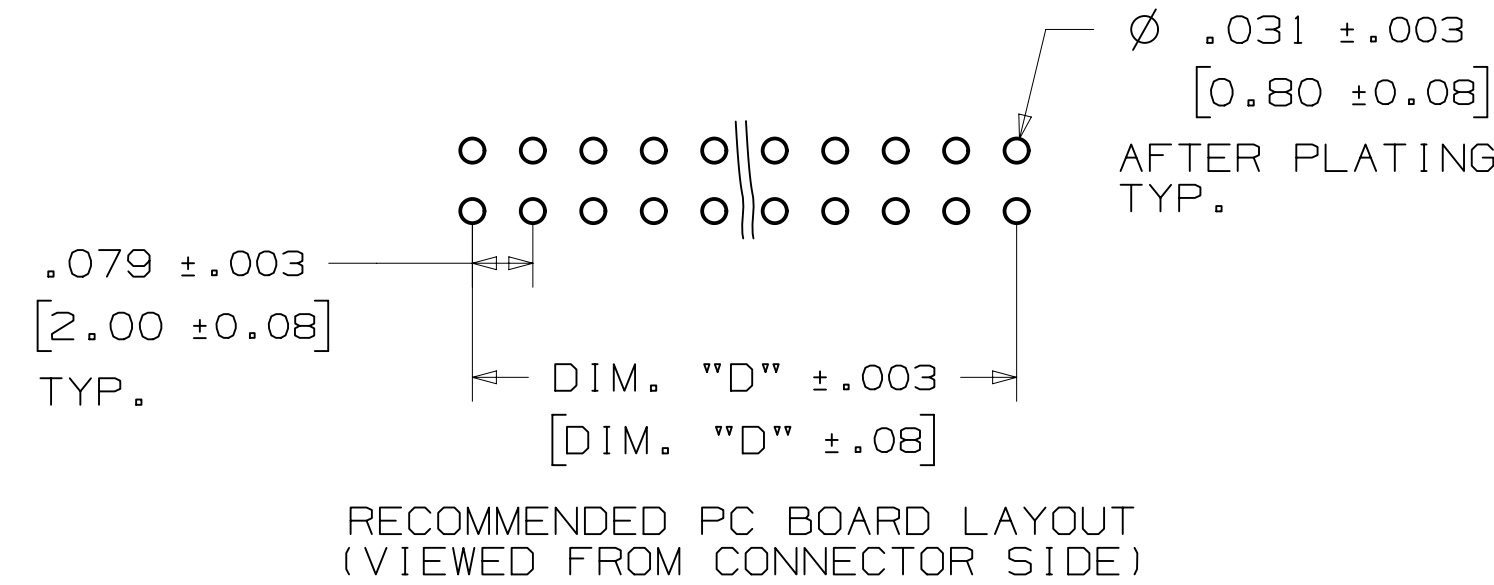
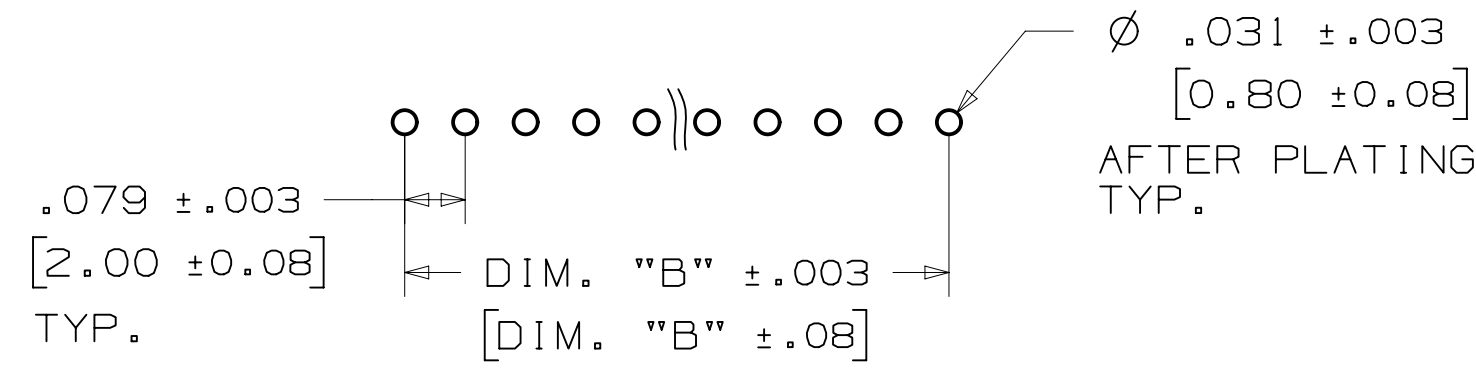
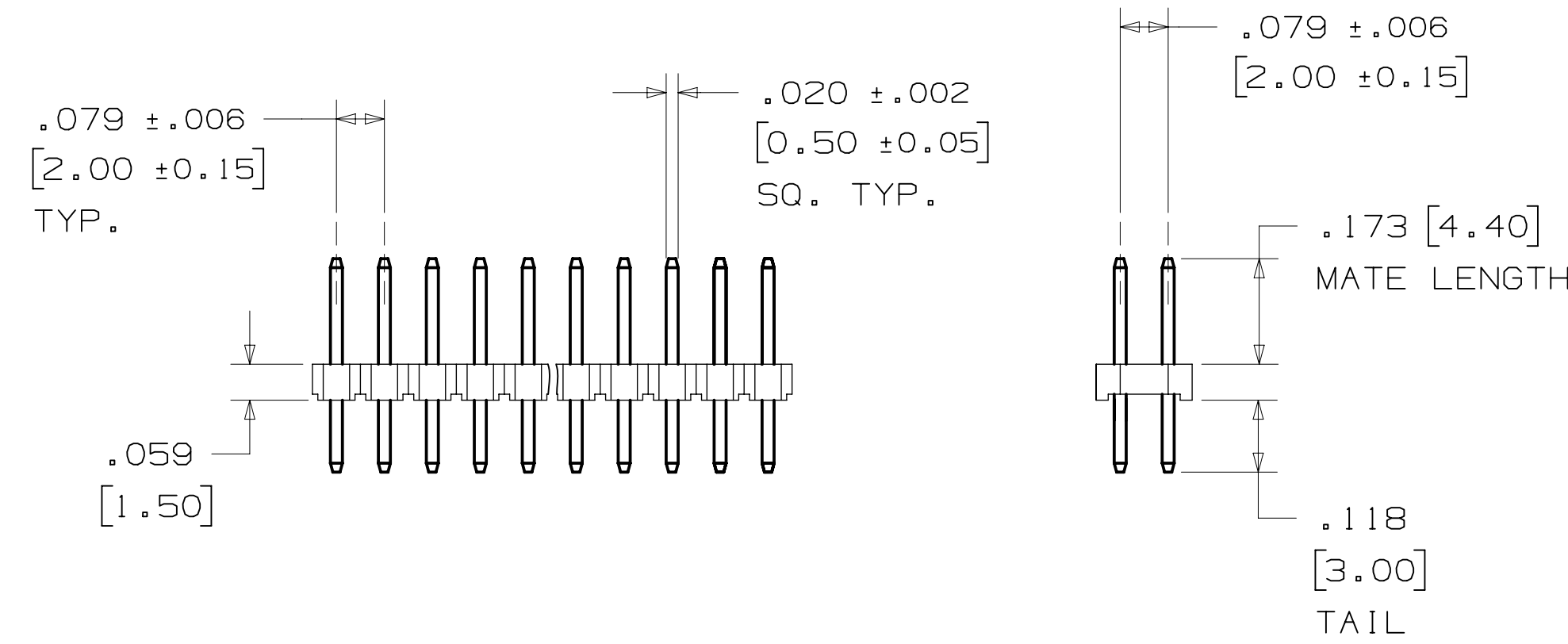
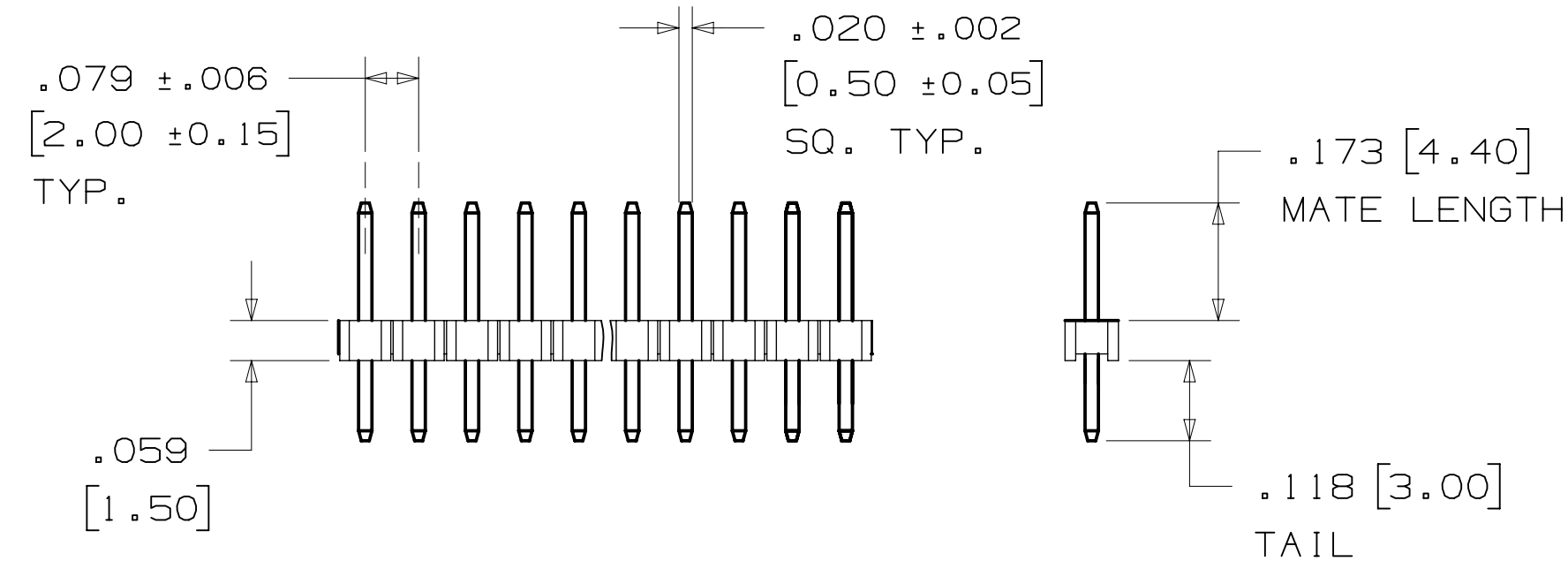
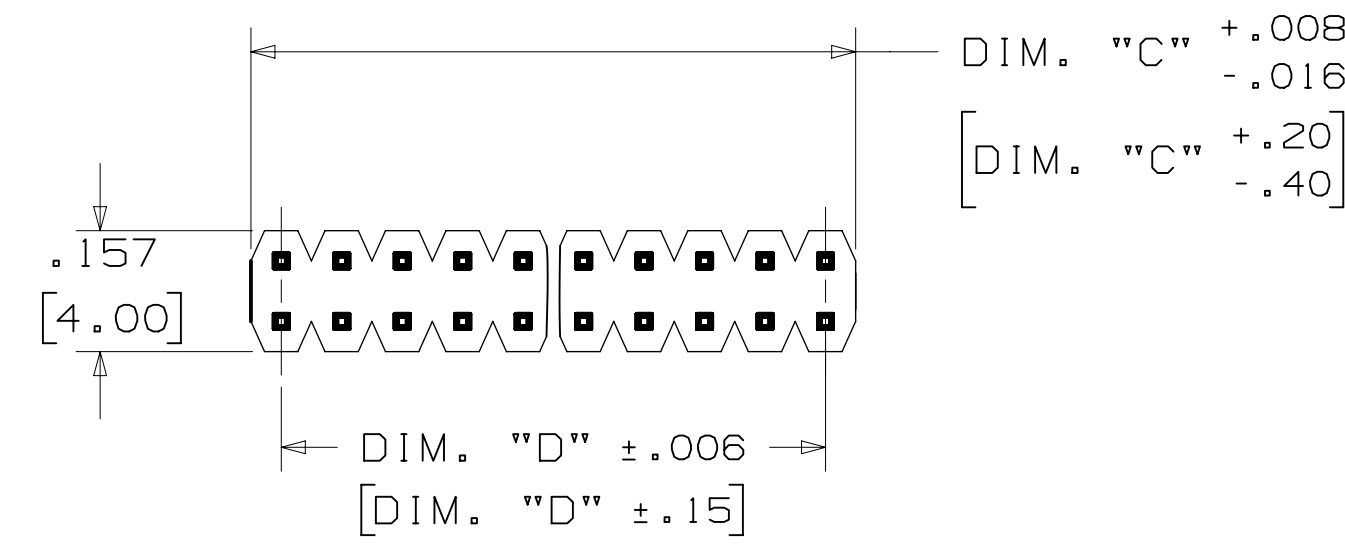

ORDERING INFORMATION STRAIGHT VERSION

951XXX-8622-AR

No. OF ROWS:
 1 = 1 ROW
 2 = 2 ROW

CONTACT QTY.
 40 PINS = 1 ROW
 80 PINS = 2 ROW

TABLE 1	
DIM. "A"	$.079$ [2.00] X N
DIM. "B"	$.079$ [2.00] X (N-1)
DIM. "C"	$.079$ [2.00] X (N/2)
DIM. "D"	$.079$ [2.00] X (N/2-1)
SEE NOTE 3	

DESIGN REFERENCE	NEXT ASSEMBLY	REV	ECO	ISSUE DATE AND DESCRIPTION	DRFT	CHKD
ACROSS CODES		CHKD		CASTIGLIONE DATE FEB 23, 2015		
DIVISION	DIVISION CODE	DATE	DATE	DATE	DATE	DATE
	EMSD					
DO NOT SCALE DRAWING	SCALE	TOLERANCES EXCEPT AS NOTED		This document and the information it contains are 3M property and may not be reproduced or further distributed without 3M permission, or used or disclosed other than for 3M authorized purposes. All rights reserved.		
	$\frac{4}{1}$	NOTED		TITLE PIN STRIP HEADER, 2MM X 2MM, STRAIGHT, SMT & RA, SOLDER TAIL		
THIRD ANGLE PROJECTION		INCHES		CAGE NUMBER D 78-5100-2653-3		
		MILLIMETERS		DRAWING NO. 78-5100-2653-3		
MAX SURFACE ROUGHNESS		INCHES		MODEL 951XXX		
		MILLIMETERS		DET. [] YES [X] NO [] SHT 2 OF 5		

78-5100-2653-3
 DRAWING NUMBER
 B
 REV. 1
 DATE FEB 23, 2015
 TIME 11:27/2017UTC
 Drf-set

3M™ PIN STRIP HEADER, 951 SERIES
 2MM AND 2MM X 2MM STRAIGHT, RIGHT ANGLE AND SURFACE MOUNT, SOLDER TAIL



RECOMMENDED PC BOARD LAYOUT
 (VIEWED FROM CONNECTOR SIDE)



RECOMMENDED PC BOARD LAYOUT
 (VIEWED FROM CONNECTOR SIDE)



ORDERING INFORMATION
 RIGHT ANGLE VERSION

951XXX-7X22-AR

No. OF ROWS:
 1 = 1 ROW
 2 = 2 ROW

CONTACT QTY:
 40 PINS = 1 ROW
 80 PINS = 2 ROW

DIM. "F" MATING PIN LENGTH:
 6 = .173 [4.40]
 7 = .295 [7.50]

DIM. "A"	.079 [2.00] X N
DIM. "B"	.079 [2.00] X (N-1)
DIM. "C"	.079 [2.00] X (N/2)
DIM. "D"	.079 [2.00] X (N/2-1)
SEE NOTE 3	

DESIGN REFERENCE	NEXT ASSEMBLY	REV	ECO	ISSUE DATE AND DESCRIPTION	DRFT	CHKD
				NOV 08, 2017 REVISE SHT 4	JNC	SC
				MAR 06, 2017 REVISE ELECTRICAL NOTES	JNC	TS
				3-2-17 REMOVED 2 CONNECTORS		
				PRODUCTION RELEASE		
APPROVED	DATE	APPROVED	DATE			
CASTIGLIONE	FEB 23, 2015	SUNIGA	FEB 23, 2015			
DIVISION		DIVISION CODE				
EMSD		EMSD				
DO NOT SCALE DRAWING	SCALE 4/1	TOLERANCES EXCEPT AS NOTED				
THIRD ANGLE PROJECTION		INCHES				
INTERPRET PER ASME Y14.5 - 2009		MILLIMETERS				
MAX SURFACE ROUGHNESS		INCHES				
MARKED SURFACES		MILLIMETERS				
MARKED ONLY		ANGLES				
CAGE NUMBER		SIZE	DRAWING NO.	REV.		
D78-5100-2653-3		B	D78-5100-2653-3	B		
MODEL		951XXX				
DET		IS1S		YES X NO		
				SHT 3 OF 5		

78-5100-2653-3
 DRAWING NUMBER
 B
 REV. 1
 11/27/2017
 JUT
 Drt-set

3M™ PIN STRIP HEADER, 951 SERIES
 2MM AND 2MM X 2MM STRAIGHT, RIGHT ANGLE AND SURFACE MOUNT, SOLDER TAIL

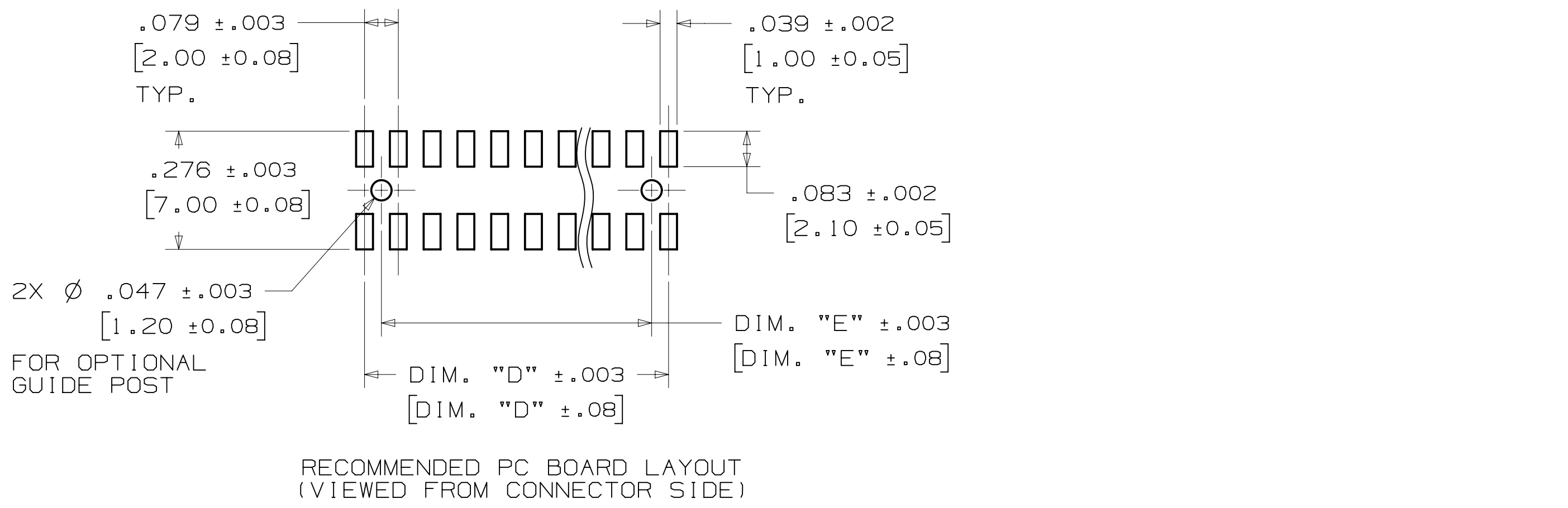
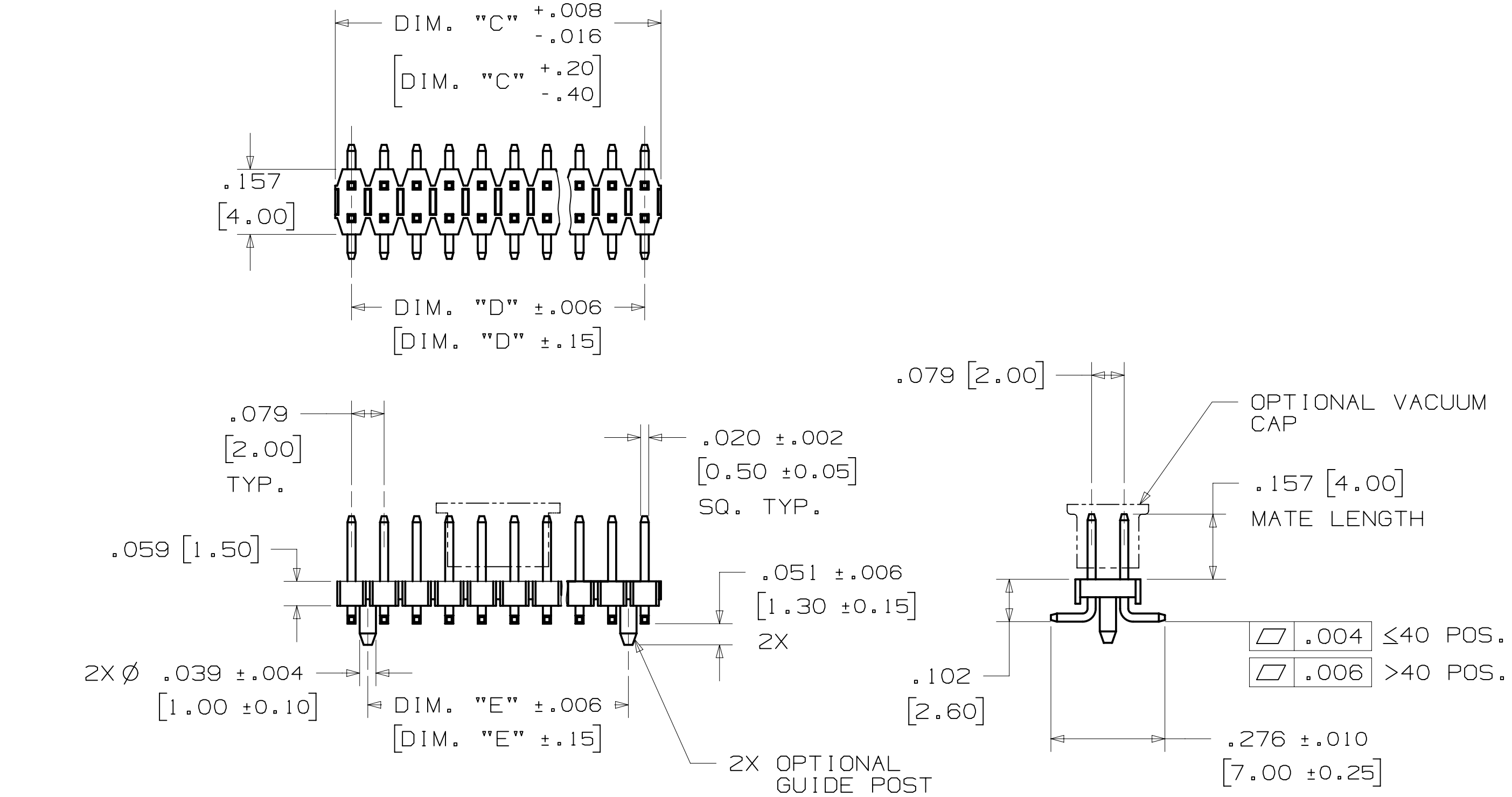

ORDERING INFORMATION
 SURFACE MOUNT VERSION

951XXX-25X0-AR-XX

No. OF ROWS:
 1 = 1 ROW
 2 = 2 ROW

CONTACT QUANTITY:
 40 PINS = 1 ROW
 80 PINS = 2 ROW

PACKAGING:
 TP = TUBE
 PT = TUBE WITH PAD
 PR = TAPE & REEL WITH PAD
 NOTE: PAD OPTIONS
 1 ROW = 40 POSITION
 2 ROW = 80 POSITION

BOARD LOCATION FEATURES:
 3 = 1 ROW / PIN 1 LEFT
 2 = 2 ROW / NONE
 5 = 2 ROW / WITH LOCATION POST
 (8 - 14 CONTACTS)

TABLE 3

DIM. "A"	.079 [2.00] X N
DIM. "B"	.079 [2.00] X (N-1)
DIM. "C"	.079 [2.00] X (N/2)
DIM. "D"	.079 [2.00] X (N/2-1)
DIM. "E"	.079 [2.00] X (N/2-2)
SEE NOTE 3	

TAPE & REEL OPTION

1 ROW	CONTACT QTY.	40
2 ROW		80
TAPE WIDTH [MM]		104

REV	ECO	ISSUE DATE AND DESCRIPTION	DRFT	CHKD
B	76546	NOV 08, 2017 REVISE SHT 4	JNC	SC
A	72044	MAR 06, 2017 REVISE ELECTRICAL NOTES 3-2-17 REMOVED 2 CONNECTORS PRODUCTION RELEASE	JNC	TS

DESIGN REFERENCE NEXT ASSEMBLY

APPROVED	DATE	APPROVED	DATE
CASTIGLIONE	FEB 23, 2015	SUNIGA	FEB 23, 2015

DIVISION CODE: EMSD

DO NOT SCALE DRAWING

SCALE: 4/1

TOLERANCES EXCEPT AS NOTED

INCHES: .00, .000, .0000

MILLIMETERS: 0, .00, .000, .0000

THIRD ANGLE PROJECTION

INTERPRET PER ASME Y14.5 - 2009

MAX SURFACE ROUGHNESS: 0.40

MARKED ONLY

3M Center St. Paul, MN 55144

© 3M COPYRIGHT 2017

This document and the information it contains are 3M property and may not be reproduced or further distributed without 3M permission, or used or disclosed other than for 3M authorized purposes. All rights reserved.

TITLE: PIN STRIP HEADER, 2MM X 2MM, STRAIGHT, SMT & RA, SOLDER TAIL

CAGE NUMBER: D78-5100-2653-3

REV. B

MODEL: 951XXX

DET: [] YES [X] NO SHT 4 OF 5

78-5100-2653-3
 DRAWING NUMBER
 B
 REVISION
 11/27/2017 UTC
 Drr-set
 B
 REVISED
 A
 REVISED

3M™ PIN STRIP HEADER, 951 SERIES
 2MM AND 2MM X 2MM STRAIGHT, RIGHT ANGLE AND SURFACE MOUNT, SOLDER TAIL

Regulatory: For regulatory information about this product, visit 3M.com/regs or contact your 3M representative.

Technical Information: The technical information, recommendations and other statements contained in this document are based upon tests or experience that 3M believes are reliable, but the accuracy or completeness of such information is not guaranteed.

Product Use: Many factors beyond 3M's control and uniquely within user's control can affect the use and performance of a 3M product in a particular application. Given the variety of factors that can affect the use and performance of a 3M product, user is solely responsible for evaluating the 3M product and determining whether it is fit for a particular purpose and suitable for user's method of application.

Warranty, Limited Remedy, and Disclaimer: Unless an additional warranty is specifically stated on the applicable 3M product packaging or product literature, 3M warrants that each 3M product meets the applicable 3M product specification at the time 3M ships the product. 3M MAKES NO OTHER WARRANTIES OR CONDITIONS, EXPRESS OR IMPLIED, INCLUDING, BUT NOT LIMITED TO, ANY IMPLIED WARRANTY OR CONDITION OF MERCHANTABILITY OR FITNESS FOR A PARTICULAR PURPOSE OR ANY IMPLIED WARRANTY OR CONDITION ARISING OUT OF A COURSE OF DEALING, CUSTOM OR USAGE OR TRADE. If the 3M product does not conform to this warranty, then the sole and exclusive remedy is, at 3M's option, replacement of the 3M product or refund of the purchase price.

Limitation of Liability: Except where prohibited by law, 3M will not be liable for any loss or damage arising from the 3M product, whether direct, indirect, special, incidental or consequential, regardless of the legal theory asserted, including warranty, contract, negligence or strict liability.

3M Electronics Materials Solutions Division
 6801 River Place Blvd.
 Austin, TX 78726-9000
 1-800-225-5373
www.3M.com/interconnect

DESIGN REFERENCE	NEXT ASSEMBLY	REV	ECO	ISSUE DATE AND DESCRIPTION	DRFT	CHKD
DO NOT SCALE DRAWING	SCALE 4 1	TOLERANCES EXCEPT AS NOTED	 © 3M COPYRIGHT 2017 This document and the information it contains are 3M property and may not be reproduced or further distributed without 3M permission, or used or disclosed other than for 3M authorized purposes. All rights reserved.			
THIRD ANGLE PROJECTION	INTERPRET PER ASME Y14.5 - 2009	MILLIMETERS	TITLE PIN STRIP HEADER, 2MM X 2MM, STRAIGHT, SMT & RA, SOLDER TAIL			
MAX SURFACE ROUGHNESS	MARKED ONLY	INCHES	CAGE NUMBER D78-5100-2653-3			
			MODEL 951XXX			
			REV. SHT 5 OF 5			

B REVISION
 78-5100-2653-3 DRAWING NUMBER
 B
 Drf-set
 A Standard Time 11/27/2017 UTC



Компания «ЭлектроПласт» предлагает заключение долгосрочных отношений при поставках импортных электронных компонентов на взаимовыгодных условиях!

Наши преимущества:

- Оперативные поставки широкого спектра электронных компонентов отечественного и импортного производства напрямую от производителей и с крупнейших мировых складов;
- Поставка более 17-ти миллионов наименований электронных компонентов;
- Поставка сложных, дефицитных, либо снятых с производства позиций;
- Оперативные сроки поставки под заказ (от 5 рабочих дней);
- Экспресс доставка в любую точку России;
- Техническая поддержка проекта, помощь в подборе аналогов, поставка прототипов;
- Система менеджмента качества сертифицирована по Международному стандарту ISO 9001;
- Лицензия ФСБ на осуществление работ с использованием сведений, составляющих государственную тайну;
- Поставка специализированных компонентов (Xilinx, Altera, Analog Devices, Intersil, Interpoint, Microsemi, Aeroflex, Peregrine, Syfer, Eurofarad, Texas Instrument, Miteq, Cobham, E2V, MA-COM, Hittite, Mini-Circuits, General Dynamics и др.);

Помимо этого, одним из направлений компании «ЭлектроПласт» является направление «Источники питания». Мы предлагаем Вам помощь Конструкторского отдела:

- Подбор оптимального решения, техническое обоснование при выборе компонента;
- Подбор аналогов;
- Консультации по применению компонента;
- Поставка образцов и прототипов;
- Техническая поддержка проекта;
- Защита от снятия компонента с производства.



Как с нами связаться

Телефон: 8 (812) 309 58 32 (многоканальный)

Факс: 8 (812) 320-02-42

Электронная почта: org@eplast1.ru

Адрес: 198099, г. Санкт-Петербург, ул. Калинина, дом 2, корпус 4, литера А.