

# Slotted Optical Switch

## OPB315 Series



### Features:

- Lateral package
- Opaque black plastic
- 850 nm wavelength
- Choice of leads or wires



### Description:

Each slotted optical switch in this series consists of an infrared emitting diode (LED) and a NPN silicon phototransistor mounted on opposite sides of a 0.90" (22.9 mm) wide slot in an opaque black plastic package.

The **OPB315L** has 0.25" minimum leads, while the **OPB315WZ** has a minimum of 24" (610 mm) 26 AWG wires.

Phototransistor switching takes place whenever an opaque object passes through the slot.

### Applications:

- Non-contact object sensing
- Assembly line automation
- Machine automation
- Equipment security
- Machine safety

Ordering Information					
Part Number	LED Peak Wavelength	Sensor	Slot Width / Depth	Aperture Emitter / Sensor	Wire or Lead Length / Gage
OPB315L	850 nm	Transistor	0.90"/0.46"	0.03" R / 0.03" R	0.25" / N/A
OPB315WZ					24" min/ 26 AWG wires

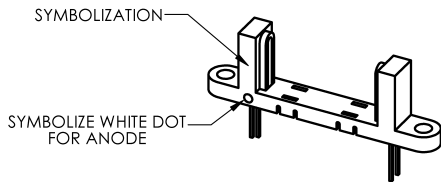

OPB315L

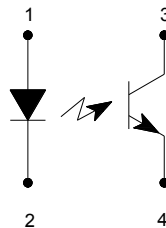

Pin #	LED	Pin #	Transistor
1	Anode	3	Collector
2	Cathode	4	Emitter

NOTES:  
1. TOLERANCES ARE ± 0.010 [0.254] UNLESS OTHERWISE SPECIFIED.

DIMENSIONS ARE IN: [MILLIMETERS]  
INCHES

OPB315L

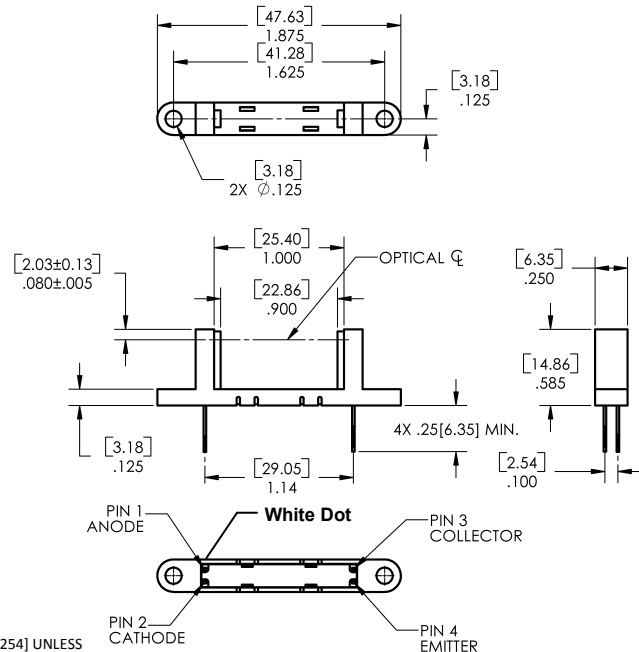

General Note  
TT Electronics reserves the right to make changes in product specification without notice or liability. All information is subject to TT Electronics' own data and is considered accurate at time of going to print.

OPTEK Technology, Inc.  
1645 Wallace Drive, Carrollton, TX 75006 | Ph: +1 972 323 2200  
www.optekinc.com | www.ttelectronics.com

# Slotted Optical Switch

OPB315 Series



## OPB315WZ

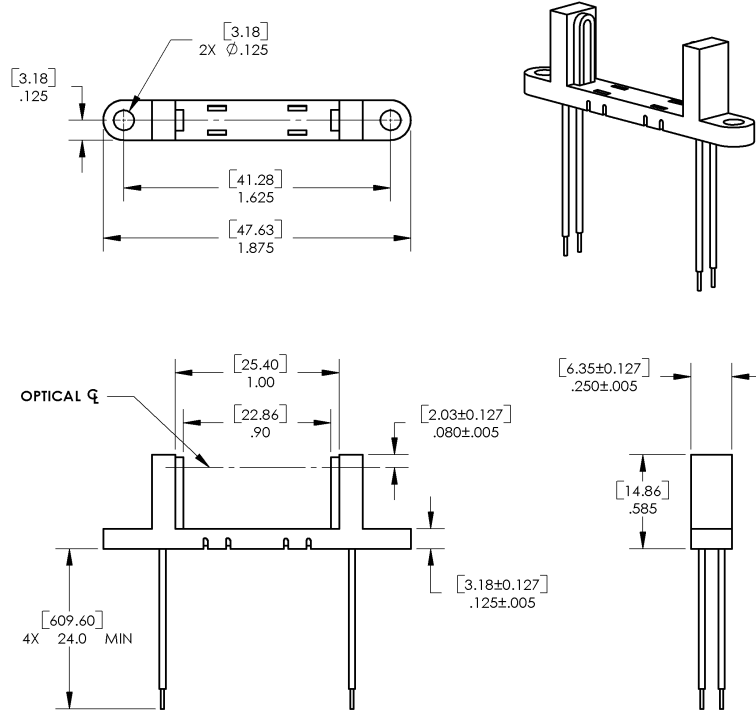

NOTES:  
 1. TOLERANCES ARE ± 0.010 UNLESS OTHERWISE SPECIFIED.  
 DIMENSIONS ARE IN: [MILLIMETERS] INCHES

## OPB315WZ

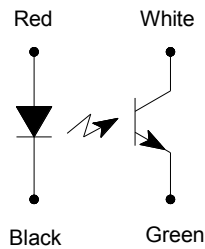

Pin #/ Color	LED	Pin #/ Color	Transistor
Black	Cathode	White	Collector
Red	Anode	Green	Emitter

General Note  
 TT Electronics reserves the right to make changes in product specification without notice or liability. All information is subject to TT Electronics' own data and is considered accurate at time of going to print.

OPTEK Technology, Inc.  
 1645 Wallace Drive, Carrollton, TX 75006 | Ph: +1 972 323 2200  
[www.optekinc.com](http://www.optekinc.com) | [www.ttelectronics.com](http://www.ttelectronics.com)

### Electrical Specifications

Absolute Maximum Ratings ( $T_A = 25^\circ\text{C}$ unless otherwise noted)	
Storage Temperature Range	-40° C to +80° C
Operating Temperature Range	-40° C to +80° C
Reverse Voltage	2.0 V
Continuous Forward Current	50 mA
Peak Forward Current [measured at 1 $\mu\text{s}$ pulse width and 300 pps]	1.0 A
Lead Soldering Temperature [1/16 inch (1.6 mm) from case for 5 seconds with soldering iron]	260° C <sup>(1)(2)</sup>
Power Dissipation (Input Diode)	100 mW
Power Dissipation (Output Phototransistor)	100 mW

Electrical Characteristics ( $T_A = 25^\circ\text{C}$ unless otherwise noted)						
SYMBOL	PARAMETER	MIN	TYP	MAX	UNITS	TEST CONDITIONS
<b>Input Diode</b>						
$V_F$	Forward Voltage	-	1.4	1.7	V	$I_F = 20\text{ mA}$
$I_R$	Reverse Current	-	-	100	$\mu\text{A}$	$V_R = 2\text{ V}$
<b>Output Phototransistor (see OP550 for additional information)</b>						
$V_{(BR)(CEO)}$	Collector-Emitter Breakdown Voltage	30	-	-	V	$I_{CE} = 100\ \mu\text{A}$ , $I_F = 0\text{ mA}$
$V_{(BR)(ECO)}$	Emitter-Collector Breakdown Voltage	5.0	-	-	V	$I_{EC} = 100\ \mu\text{A}$ , $I_F = 0\text{ mA}$ , $E_E = 0$
$I_{CEO}$	Collector-Emitter Leakage Current	-	-	100	nA	$V_{CE} = 10.0\text{ V}$ , $I_F = 0\text{ mA}$ , $E_E = 0$
<b>Coupled</b>						
$I_{C(ON)}$	On-State Collector Current	0.5	1.0	-	mA	$V_{CE} = 0.4\text{ V}$ , $I_F = 20\text{ mA}$
$V_{CE(SAT)}$	Collector-Emitter	-	-	0.4	V	$I_C = 500\ \mu\text{A}$ , $I_F = 20\text{ mA}$

**Notes:**

1. RMA flux is recommended. Duration can be extended to 10 seconds maximum when flow soldering.
2. Derate linearly 1.33 mW/° C above 25° C.

### OPB315

Forward Voltage vs Forward Current vs Temperature

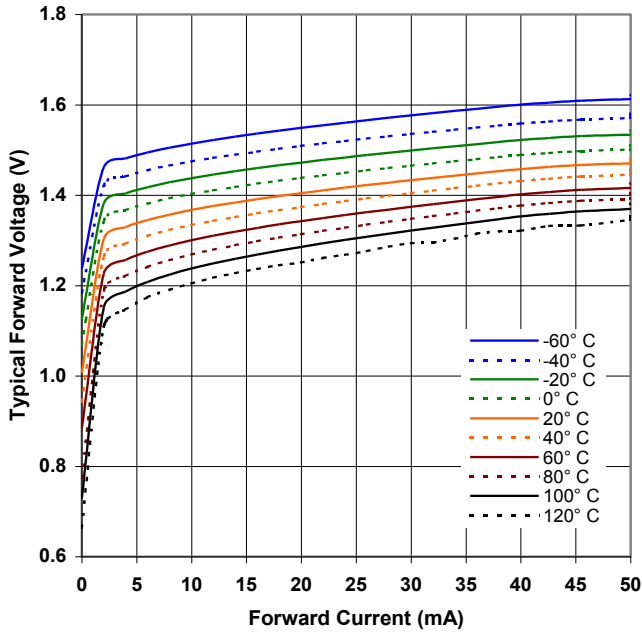

Optical Power vs Forward Current vs Temperature

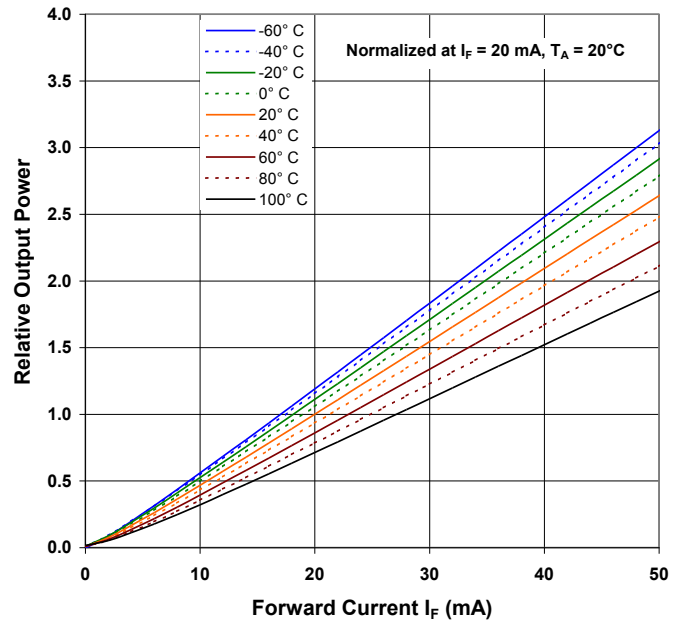

OPB315 - Flag Next to Emitter

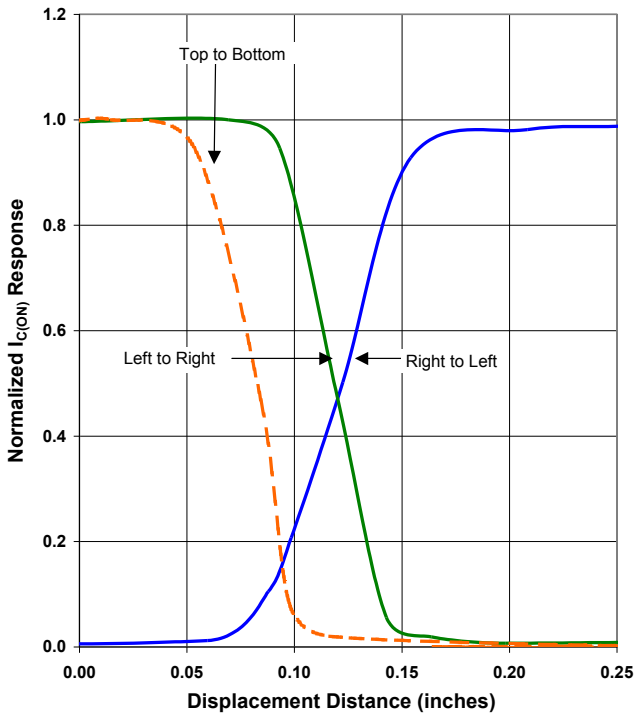

OPB315 - Flag Next to Sensor

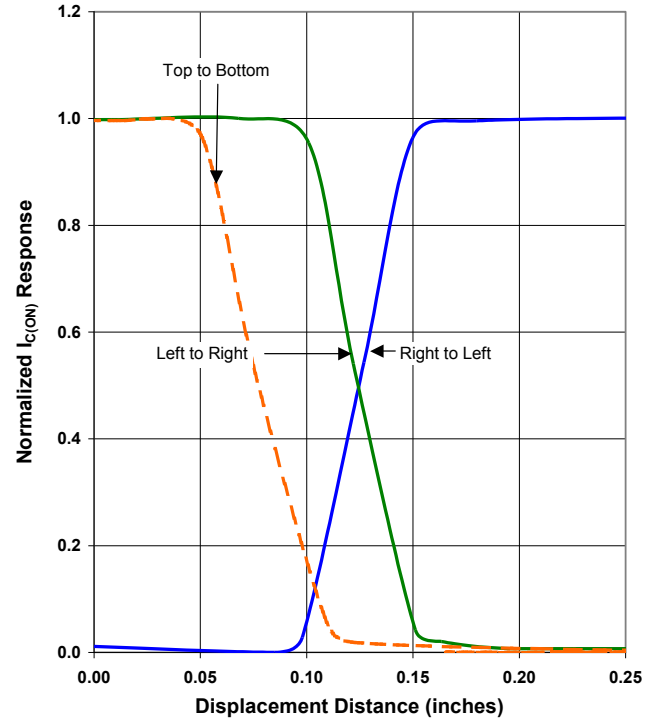

General Note  
TT Electronics reserves the right to make changes in product specification without notice or liability. All information is subject to TT Electronics' own data and is considered accurate at time of going to print.

OPTEK Technology, Inc.  
1645 Wallace Drive, Carrollton, TX 75006 | Ph: +1 972 323 2200  
www.optekinc.com | www.ttelectronics.com



Компания «ЭлектроПласт» предлагает заключение долгосрочных отношений при поставках импортных электронных компонентов на взаимовыгодных условиях!

Наши преимущества:

- Оперативные поставки широкого спектра электронных компонентов отечественного и импортного производства напрямую от производителей и с крупнейших мировых складов;
- Поставка более 17-ти миллионов наименований электронных компонентов;
- Поставка сложных, дефицитных, либо снятых с производства позиций;
- Оперативные сроки поставки под заказ (от 5 рабочих дней);
- Экспресс доставка в любую точку России;
- Техническая поддержка проекта, помощь в подборе аналогов, поставка прототипов;
- Система менеджмента качества сертифицирована по Международному стандарту ISO 9001;
- Лицензия ФСБ на осуществление работ с использованием сведений, составляющих государственную тайну;
- Поставка специализированных компонентов (Xilinx, Altera, Analog Devices, Intersil, Interpoint, Microsemi, Aeroflex, Peregrine, Syfer, Eurofarad, Texas Instrument, Miteq, Cobham, E2V, MA-COM, Hittite, Mini-Circuits, General Dynamics и др.);

Помимо этого, одним из направлений компании «ЭлектроПласт» является направление «Источники питания». Мы предлагаем Вам помощь Конструкторского отдела:

- Подбор оптимального решения, техническое обоснование при выборе компонента;
- Подбор аналогов;
- Консультации по применению компонента;
- Поставка образцов и прототипов;
- Техническая поддержка проекта;
- Защита от снятия компонента с производства.



#### Как с нами связаться

**Телефон:** 8 (812) 309 58 32 (многоканальный)

**Факс:** 8 (812) 320-02-42

**Электронная почта:** [org@eplast1.ru](mailto:org@eplast1.ru)

**Адрес:** 198099, г. Санкт-Петербург, ул. Калинина, дом 2, корпус 4, литера А.