



# BFU530A

NPN wideband silicon RF transistor

Rev. 1 — 13 January 2014

Product data sheet

## 1. Product profile

### 1.1 General description

NPN silicon RF transistor for high speed, low noise applications in a plastic, 3-pin SOT23 package.

The BFU530A is part of the BFU5 family of transistors, suitable for small signal to medium power applications up to 2 GHz.

### 1.2 Features and benefits

- Low noise, high breakdown RF transistor
- AEC-Q101 qualified
- Minimum noise figure ( $NF_{min}$ ) = 0.6 dB at 900 MHz
- Maximum stable gain 18 dB at 900 MHz
- 11 GHz  $f_T$  silicon technology

### 1.3 Applications

- Applications requiring high supply voltages and high breakdown voltages
- Broadband amplifiers up to 2 GHz
- Low noise amplifiers for ISM applications
- ISM band oscillators

### 1.4 Quick reference data

**Table 1. Quick reference data**

$T_{amb} = 25\text{ °C}$  unless otherwise specified

| Symbol    | Parameter                 | Conditions  | Min | Typ  | Max | Unit |
|-----------|---------------------------|---|-----|------|-----|------|
| $V_{CB}$  | collector-base voltage    | open emitter  | -   | -    | 24  | V    |
| $V_{CE}$  | collector-emitter voltage | open base   | -   | -    | 12  | V    |
|           |                           | shorted base  | -   | -    | 24  | V    |
| $V_{EB}$  | emitter-base voltage      | open collector  | -   | -    | 2   | V    |
| $I_C$     | collector current         |   | -   | 10   | 40  | mA   |
| $P_{tot}$ | total power dissipation   | $T_{sp} \leq 87\text{ °C}$                                    | [1] | -    | 450 | mW   |
| $h_{FE}$  | DC current gain           | $I_C = 10\text{ mA}; V_{CE} = 8\text{ V}$                     | 60  | 95   | 200 |      |
| $C_c$     | collector capacitance     | $V_{CB} = 8\text{ V}; f = 1\text{ MHz}$                       | -   | 0.67 | -   | pF   |
| $f_T$     | transition frequency      | $I_C = 15\text{ mA}; V_{CE} = 8\text{ V}; f = 900\text{ MHz}$ | -   | 11   | -   | GHz  |



**Table 1. Quick reference data ...continued**  
 $T_{amb} = 25\text{ }^{\circ}\text{C}$  unless otherwise specified

| Symbol       | Parameter                             | Conditions   | Min | Typ | Max | Unit |
|--------------|---------------------------------------|--|-----|-----|-----|------|
| $G_{p(max)}$ | maximum power gain                    | $I_C = 10\text{ mA}$ ; $V_{CE} = 8\text{ V}$ ; $f = 900\text{ MHz}$                                  | [2] | -   | 18  | - dB |
| $NF_{min}$   | minimum noise figure                  | $I_C = 1\text{ mA}$ ; $V_{CE} = 8\text{ V}$ ; $f = 900\text{ MHz}$ ; $\Gamma_S = \Gamma_{opt}$       | -   | 0.6 | -   | dB   |
| $P_{L(1dB)}$ | output power at 1 dB gain compression | $I_C = 15\text{ mA}$ ; $V_{CE} = 8\text{ V}$ ; $Z_S = Z_L = 50\text{ }\Omega$ ; $f = 900\text{ MHz}$ | -   | 10  | -   | dBm  |

- [1]  $T_{sp}$  is the temperature at the solder point of the collector lead.  
 [2] If  $K > 1$  then  $G_{p(max)}$  is the maximum power gain. If  $K < 1$  then  $G_{p(max)} = MSG$ .

## 2. Pinning information

**Table 2. Discrete pinning**

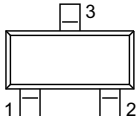
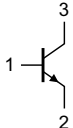
| Pin | Description | Simplified outline  | Graphic symbol   |
|-----|-------------|---|--|
| 1   | base        |  | <br>aaa-010458 |
| 2   | emitter     |   |  |
| 3   | collector   |   |  |

## 3. Ordering information

**Table 3. Ordering information**

| Type number | Package |  | Version |
|-------------|---------|--|---------|
|             | Name    | Description  |         |
| BFU530A     | -       | plastic surface-mounted package; 3 leads                     | SOT23   |
| OM7961      | -       | Customer evaluation kit for BFU520A, BFU530A and BFU550A [1] | -       |

- [1] The customer evaluation kit contains the following:
- Unpopulated RF amplifier Printed-Circuit Board (PCB)
  - Unpopulated RF amplifier Printed-Circuit Board (PCB) with emitter degeneration
  - Four SMA connectors for fitting unpopulated Printed-Circuit Board (PCB)
  - BFU520A, BFU530A and BFU550A samples
  - USB stick with data sheets, application notes, models, S-parameter and noise files

## 4. Marking

**Table 4. Marking**

| Type number | Marking | Description                                       |
|-------------|---------|---|
| BFU530A     | HY*     | * = t : made in Malaysia<br>* = w : made in China |

## 5. Design support

**Table 5. Available design support**

Download from the BFU530A product information page on <http://www.nxp.com>.

| Support item                            | Available | Remarks   |
|---|-----------|---|
| Device models for Agilent EESof EDA ADS | yes       | Based on Mextram device model.                                      |
| SPICE model                             | yes       | Based on Gummel-Poon device model.                                  |
| S-parameters                            | yes       |   |
| Noise parameters                        | yes       |   |
| Customer evaluation kit                 | yes       | See <a href="#">Section 3</a> and <a href="#">Section 10</a> .      |
| Solder pattern                          | yes       |   |
| Application notes                       | yes       | See <a href="#">Section 10.1</a> and <a href="#">Section 10.2</a> . |

## 6. Limiting values

**Table 6. Limiting values**

In accordance with the Absolute Maximum Rating System (IEC 60134).

| Symbol    | Parameter                       | Conditions  | Min | Max  | Unit |
|-----------|---------------------------------|---|-----|------|------|
| $V_{CB}$  | collector-base voltage          | open emitter  | -   | 30   | V    |
| $V_{CE}$  | collector-emitter voltage       | open base   | -   | 16   | V    |
|           |                                 | shorted base  | -   | 30   | V    |
| $V_{EB}$  | emitter-base voltage            | open collector  | -   | 3    | V    |
| $I_C$     | collector current               |   | -   | 65   | mA   |
| $T_{stg}$ | storage temperature             |   | -65 | +150 | °C   |
| $V_{ESD}$ | electrostatic discharge voltage | Human Body Model (HBM) According to JEDEC standard 22-A114E     | -   | ±150 | V    |
|           |                                 | Charged Device Model (CDM) According to JEDEC standard 22-C101B | -   | ±2   | kV   |

## 7. Recommended operating conditions

**Table 7. Characteristics**

| Symbol    | Parameter                 | Conditions                  | Min | Typ | Max  | Unit |
|-----------|---------------------------|-----------------------------|-----|-----|------|------|
| $V_{CB}$  | collector-base voltage    | open emitter                | -   | -   | 24   | V    |
| $V_{CE}$  | collector-emitter voltage | open base                   | -   | -   | 12   | V    |
|           |                           | shorted base                | -   | -   | 24   | V    |
| $V_{EB}$  | emitter-base voltage      | open collector              | -   | -   | 2    | V    |
| $I_C$     | collector current         |                             | -   | -   | 40   | mA   |
| $P_i$     | input power               | $Z_S = 50 \Omega$           | -   | -   | 10   | dBm  |
| $T_j$     | junction temperature      |                             | -40 | -   | +150 | °C   |
| $P_{tot}$ | total power dissipation   | $T_{sp} \leq 87 \text{ °C}$ | [1] | -   | 450  | mW   |

[1]  $T_{sp}$  is the temperature at the solder point of the collector lead.

## 8. Thermal characteristics

**Table 8. Thermal characteristics**

| Symbol         | Parameter  | Conditions | Typ     | Unit |
|----------------|--|------------|---------|------|
| $R_{th(j-sp)}$ | thermal resistance from junction to solder point |            | [1] 140 | K/W  |

[1]  $T_{sp}$  is the temperature at the solder point of the collector lead.

$T_{sp}$  has the following relation to the ambient temperature  $T_{amb}$ :

$$T_{sp} = T_{amb} + P \times R_{th(sp-a)}$$

With P being the power dissipation and  $R_{th(sp-a)}$  being the thermal resistance between the solder point and ambient.  $R_{th(sp-a)}$  is determined by the heat transfer properties in the application.

The heat transfer properties are set by the application board materials, the board layout and the environment e.g. housing.



**Fig 1. Power derating curve**

## 9. Characteristics

**Table 9. Characteristics**

$T_{amb} = 25\text{ °C}$  unless otherwise specified

| Symbol        | Parameter                           | Conditions  | Min | Typ  | Max | Unit |
|---------------|-------------------------------------|---|-----|------|-----|------|
| $V_{(BR)CBO}$ | collector-base breakdown voltage    | $I_C = 100\text{ nA}; I_E = 0\text{ mA}$                      | 24  | -    | -   | V    |
| $V_{(BR)CEO}$ | collector-emitter breakdown voltage | $I_C = 150\text{ nA}; I_B = 0\text{ mA}$                      | 12  | -    | -   | V    |
| $I_C$         | collector current                   |   | -   | 10   | 40  | mA   |
| $I_{CBO}$     | collector-base cut-off current      | $I_E = 0\text{ mA}; V_{CB} = 8\text{ V}$                      | -   | <1   | -   | nA   |
| $h_{FE}$      | DC current gain                     | $I_C = 10\text{ mA}; V_{CE} = 8\text{ V}$                     | 60  | 95   | 200 |      |
| $C_e$         | emitter capacitance                 | $V_{EB} = 0.5\text{ V}; f = 1\text{ MHz}$                     | -   | 0.83 | -   | pF   |
| $C_{re}$      | feedback capacitance                | $V_{CE} = 8\text{ V}; f = 1\text{ MHz}$                       | -   | 0.43 | -   | pF   |
| $C_c$         | collector capacitance               | $V_{CB} = 8\text{ V}; f = 1\text{ MHz}$                       | -   | 0.67 | -   | pF   |
| $f_T$         | transition frequency                | $I_C = 15\text{ mA}; V_{CE} = 8\text{ V}; f = 900\text{ MHz}$ | -   | 11   | -   | GHz  |

**Table 9. Characteristics ...continued**  
 $T_{amb} = 25\text{ }^{\circ}\text{C}$  unless otherwise specified

| Symbol       | Parameter            | Conditions  | Min | Typ  | Max | Unit |
|--------------|----------------------|---|-----|------|-----|------|
| $G_{p(max)}$ | maximum power gain   | $f = 433\text{ MHz}; V_{CE} = 8\text{ V}$                           | [1] |      |     |      |
|              |                      | $I_C = 1\text{ mA}$   | -   | 15.5 | -   | dB   |
|              |                      | $I_C = 10\text{ mA}$  | -   | 23   | -   | dB   |
|              |                      | $I_C = 15\text{ mA}$  | -   | 23.5 | -   | dB   |
|              |                      | $f = 900\text{ MHz}; V_{CE} = 8\text{ V}$                           | [1] |      |     |      |
|              |                      | $I_C = 1\text{ mA}$   | -   | 12.5 | -   | dB   |
|              |                      | $I_C = 10\text{ mA}$  | -   | 18   | -   | dB   |
|              |                      | $I_C = 15\text{ mA}$  | -   | 18   | -   | dB   |
|              |                      | $f = 1800\text{ MHz}; V_{CE} = 8\text{ V}$                          | [1] |      |     |      |
|              |                      | $I_C = 1\text{ mA}$   | -   | 10.5 | -   | dB   |
|              |                      | $I_C = 10\text{ mA}$  | -   | 12   | -   | dB   |
|              |                      | $I_C = 15\text{ mA}$  | -   | 12   | -   | dB   |
| $ S_{21} ^2$ | insertion power gain | $f = 433\text{ MHz}; V_{CE} = 8\text{ V}$                           |     |      |     |      |
|              |                      | $I_C = 1\text{ mA}$   | -   | 10   | -   | dB   |
|              |                      | $I_C = 10\text{ mA}$  | -   | 21   | -   | dB   |
|              |                      | $I_C = 15\text{ mA}$  | -   | 21   | -   | dB   |
|              |                      | $f = 900\text{ MHz}; V_{CE} = 8\text{ V}$                           |     |      |     |      |
|              |                      | $I_C = 1\text{ mA}$   | -   | 8.5  | -   | dB   |
|              |                      | $I_C = 10\text{ mA}$  | -   | 15   | -   | dB   |
|              |                      | $I_C = 15\text{ mA}$  | -   | 15.5 | -   | dB   |
|              |                      | $f = 1800\text{ MHz}; V_{CE} = 8\text{ V}$                          |     |      |     |      |
|              |                      | $I_C = 1\text{ mA}$   | -   | 5    | -   | dB   |
|              |                      | $I_C = 10\text{ mA}$  | -   | 10   | -   | dB   |
|              |                      | $I_C = 15\text{ mA}$  | -   | 10   | -   | dB   |
| $NF_{min}$   | minimum noise figure | $f = 433\text{ MHz}; V_{CE} = 8\text{ V}; \Gamma_S = \Gamma_{opt}$  |     |      |     |      |
|              |                      | $I_C = 1\text{ mA}$   | -   | 0.5  | -   | dB   |
|              |                      | $I_C = 10\text{ mA}$  | -   | 0.8  | -   | dB   |
|              |                      | $I_C = 15\text{ mA}$  | -   | 0.9  | -   | dB   |
|              |                      | $f = 900\text{ MHz}; V_{CE} = 8\text{ V}; \Gamma_S = \Gamma_{opt}$  |     |      |     |      |
|              |                      | $I_C = 1\text{ mA}$   | -   | 0.6  | -   | dB   |
|              |                      | $I_C = 10\text{ mA}$  | -   | 0.9  | -   | dB   |
|              |                      | $I_C = 15\text{ mA}$  | -   | 1.0  | -   | dB   |
|              |                      | $f = 1800\text{ MHz}; V_{CE} = 8\text{ V}; \Gamma_S = \Gamma_{opt}$ |     |      |     |      |
|              |                      | $I_C = 1\text{ mA}$   | -   | 0.7  | -   | dB   |
|              |                      | $I_C = 10\text{ mA}$  | -   | 1.0  | -   | dB   |
|              |                      | $I_C = 15\text{ mA}$  | -   | 1.1  | -   | dB   |

**Table 9. Characteristics ...continued**  
 $T_{amb} = 25\text{ }^{\circ}\text{C}$  unless otherwise specified

| Symbol  | Parameter                             | Conditions   | Min                                | Typ   | Max | Unit |   |     |
|---|---------------------------------------|--|------------------------------------|---|-----|------|---|-----|
| $G_{ass}$   | associated gain                       | $f = 433\text{ MHz}; V_{CE} = 8\text{ V}; \Gamma_S = \Gamma_{opt}$       |                                    |   |     |      |   |     |
|   |                                       | $I_C = 1\text{ mA}$  | -                                  | 22  | -   | dB   |   |     |
|   |                                       | $I_C = 10\text{ mA}$   | -                                  | 22  | -   | dB   |   |     |
|   |                                       | $I_C = 15\text{ mA}$   | -                                  | 22  | -   | dB   |   |     |
|   |                                       | $f = 900\text{ MHz}; V_{CE} = 8\text{ V}; \Gamma_S = \Gamma_{opt}$       |                                    |   |     |      |   |     |
|   |                                       | $I_C = 1\text{ mA}$  | -                                  | 14.5  | -   | dB   |   |     |
|   |                                       | $I_C = 10\text{ mA}$   | -                                  | 16  | -   | dB   |   |     |
|   |                                       | $I_C = 15\text{ mA}$   | -                                  | 16  | -   | dB   |   |     |
|   |                                       | $f = 1800\text{ MHz}; V_{CE} = 8\text{ V}; \Gamma_S = \Gamma_{opt}$      |                                    |   |     |      |   |     |
|   |                                       | $I_C = 1\text{ mA}$  | -                                  | 8   | -   | dB   |   |     |
|   |                                       | $I_C = 10\text{ mA}$   | -                                  | 10.5  | -   | dB   |   |     |
|   |                                       | $I_C = 15\text{ mA}$   | -                                  | 10.5  | -   | dB   |   |     |
| $P_{L(1dB)}$  | output power at 1 dB gain compression | $f = 433\text{ MHz}; V_{CE} = 8\text{ V}; Z_S = Z_L = 50\text{ }\Omega$  |                                    |   |     |      |   |     |
|   |                                       | $I_C = 10\text{ mA}$   | -                                  | 6   | -   | dBm  |   |     |
|   |                                       | $I_C = 15\text{ mA}$   | -                                  | 9.5   | -   | dBm  |   |     |
|   |                                       | $f = 900\text{ MHz}; V_{CE} = 8\text{ V}; Z_S = Z_L = 50\text{ }\Omega$  |                                    |   |     |      |   |     |
|   |                                       | $I_C = 10\text{ mA}$   | -                                  | 7   | -   | dBm  |   |     |
|   |                                       | $I_C = 15\text{ mA}$   | -                                  | 10  | -   | dBm  |   |     |
|   |                                       | $f = 1800\text{ MHz}; V_{CE} = 8\text{ V}; Z_S = Z_L = 50\text{ }\Omega$ |                                    |   |     |      |   |     |
|   |                                       | $I_C = 10\text{ mA}$   | -                                  | 8   | -   | dBm  |   |     |
|   |                                       | $I_C = 15\text{ mA}$   | -                                  | 10.5  | -   | dBm  |   |     |
|   |                                       | $IP3_o$  | output third-order intercept point | $f_1 = 433\text{ MHz}; f_2 = 434\text{ MHz}; V_{CE} = 8\text{ V}; Z_S = Z_L = 50\text{ }\Omega$ |     |      |   |     |
|   |                                       |  |                                    | $I_C = 10\text{ mA}$  | -   | 16   | - | dBm |
|   |                                       |  |                                    | $I_C = 15\text{ mA}$  | -   | 19   | - | dBm |
| $f_1 = 900\text{ MHz}; f_2 = 901\text{ MHz}; V_{CE} = 8\text{ V}; Z_S = Z_L = 50\text{ }\Omega$   |                                       |  |                                    |   |     |      |   |     |
| $I_C = 10\text{ mA}$  | -                                     |  |                                    | 17  | -   | dBm  |   |     |
| $I_C = 15\text{ mA}$  | -                                     |  |                                    | 20  | -   | dBm  |   |     |
| $f_1 = 1800\text{ MHz}; f_2 = 1801\text{ MHz}; V_{CE} = 8\text{ V}; Z_S = Z_L = 50\text{ }\Omega$ |                                       |  |                                    |   |     |      |   |     |
| $I_C = 10\text{ mA}$  | -                                     |  |                                    | 18  | -   | dBm  |   |     |
| $I_C = 15\text{ mA}$  | -                                     |  |                                    | 20  | -   | dBm  |   |     |

[1] If  $K > 1$  then  $G_{p(max)}$  is the maximum power gain. If  $K < 1$  then  $G_{p(max)} = MSG$ .

9.1 Graphs

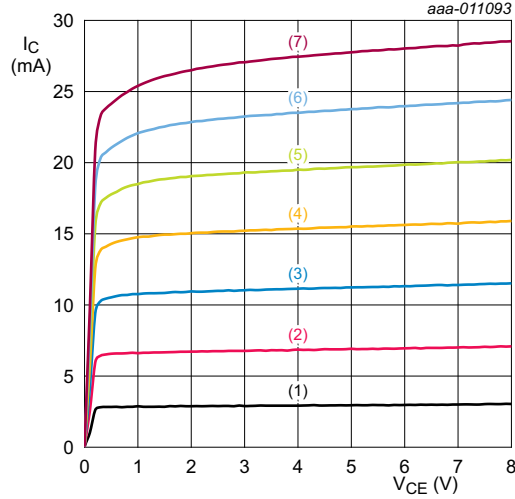

$T_{amb} = 25\text{ }^\circ\text{C}$ .

- (1)  $I_B = 25\text{ }\mu\text{A}$
- (2)  $I_B = 75\text{ }\mu\text{A}$
- (3)  $I_B = 125\text{ }\mu\text{A}$
- (4)  $I_B = 175\text{ }\mu\text{A}$
- (5)  $I_B = 225\text{ }\mu\text{A}$
- (6)  $I_B = 275\text{ }\mu\text{A}$
- (7)  $I_B = 325\text{ }\mu\text{A}$

Fig 2. Collector current as a function of collector-emitter voltage; typical values



$T_{amb} = 25\text{ }^\circ\text{C}$ .

- (1)  $V_{CE} = 3.0\text{ V}$
- (2)  $V_{CE} = 8.0\text{ V}$

Fig 3. DC current gain as function of collector current; typical values



$V_{CE} = 8\text{ V}$ .

- (1)  $T_{amb} = -40\text{ }^\circ\text{C}$
- (2)  $T_{amb} = +25\text{ }^\circ\text{C}$
- (3)  $T_{amb} = +125\text{ }^\circ\text{C}$

Fig 4. DC current gain as function of collector current; typical values



$T_{amb} = 25$  °C.  
 (1)  $V_{CE} = 3.0$  V  
 (2)  $V_{CE} = 8.0$  V

**Fig 5. Collector current as a function of base-emitter voltage; typical values**



$T_{amb} = 25$  °C.  
 (1)  $V_{CE} = 3.0$  V  
 (2)  $V_{CE} = 8.0$  V

**Fig 6. Base current as a function of base-emitter voltage; typical values**

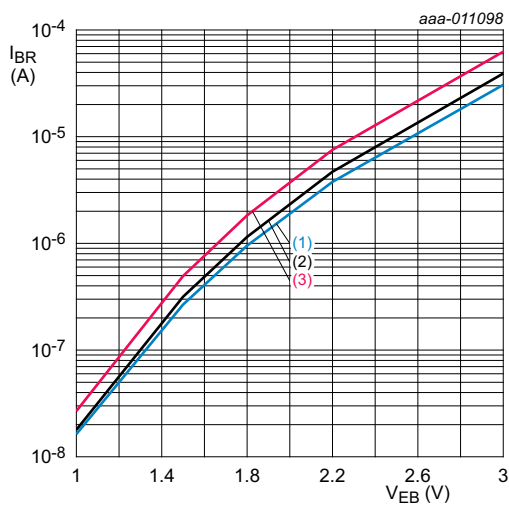

$V_{CE} = 3$  V.  
 (1)  $T_{amb} = -40$  °C  
 (2)  $T_{amb} = +25$  °C  
 (3)  $T_{amb} = +125$  °C

**Fig 7. Reverse base current as a function of emitter-base voltage; typical values**



$I_C = 0$  mA;  $f = 1$  MHz;  $T_{amb} = 25$  °C.

**Fig 8. Collector capacitance as a function of collector-base voltage; typical values**



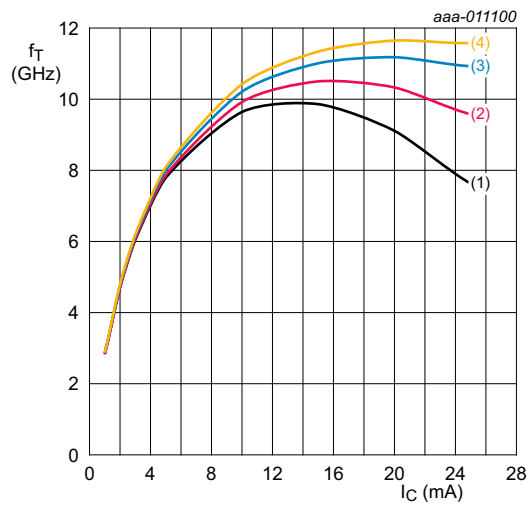

- $T_{amb} = 25\text{ }^{\circ}\text{C}.$
- (1)  $V_{CE} = 3.3\text{ V}$
  - (2)  $V_{CE} = 5.0\text{ V}$
  - (3)  $V_{CE} = 8.0\text{ V}$
  - (4)  $V_{CE} = 12.0\text{ V}$

Fig 9. Transition frequency as a function of collector current; typical values



$I_C = 10\text{ mA}; V_{CE} = 8\text{ V}; T_{amb} = 25\text{ }^{\circ}\text{C}.$

Fig 10. Gain as a function of frequency; typical values



$I_C = 15\text{ mA}; V_{CE} = 8\text{ V}; T_{amb} = 25\text{ }^{\circ}\text{C}.$

Fig 11. Gain as a function of frequency; typical values



$V_{CE} = 8\text{ V}; T_{amb} = 25\text{ }^{\circ}\text{C}.$   
 (1)  $f = 300\text{ MHz}$   
 (2)  $f = 433\text{ MHz}$   
 (3)  $f = 800\text{ MHz}$   
 (4)  $f = 900\text{ MHz}$   
 (5)  $f = 1800\text{ MHz}$

**Fig 12. Insertion power gain as a function of collector current; typical values**



$V_{CE} = 8\text{ V}; T_{amb} = 25\text{ }^{\circ}\text{C}.$   
 If  $K > 1$  then  $G_{p(max)}$  = maximum power gain. If  $K < 1$  then  $G_{p(max)}$  = MSG.  
 (1)  $f = 300\text{ MHz}$   
 (2)  $f = 433\text{ MHz}$   
 (3)  $f = 800\text{ MHz}$   
 (4)  $f = 900\text{ MHz}$   
 (5)  $f = 1800\text{ MHz}$

**Fig 13. Maximum power gain as a function of collector current; typical values**

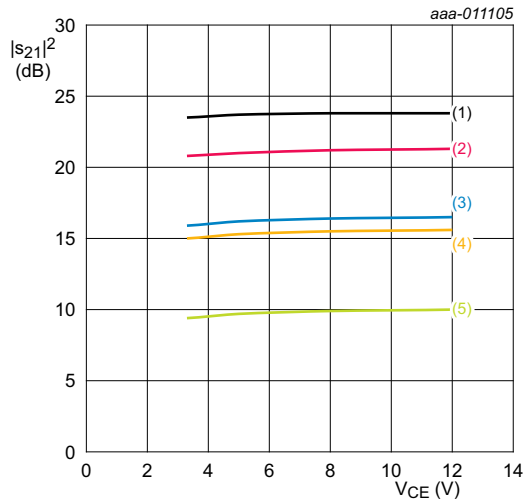

$I_C = 15 \text{ mA}; T_{amb} = 25 \text{ }^\circ\text{C}.$   
 (1)  $f = 300 \text{ MHz}$   
 (2)  $f = 433 \text{ MHz}$   
 (3)  $f = 800 \text{ MHz}$   
 (4)  $f = 900 \text{ MHz}$   
 (5)  $f = 1800 \text{ MHz}$

**Fig 14. Insertion power gain as a function of collector-emitter voltage; typical values**

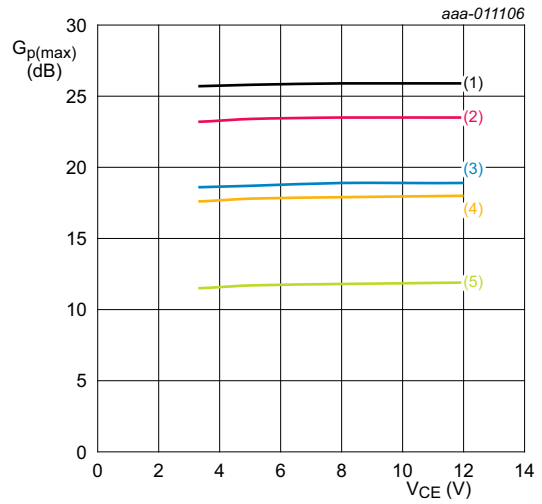

$I_C = 15 \text{ mA}; T_{amb} = 25 \text{ }^\circ\text{C}.$   
 If  $K > 1$  then  $G_{p(max)}$  = maximum power gain. If  $K < 1$  then  $G_{p(max)}$  = MSG.  
 (1)  $f = 300 \text{ MHz}$   
 (2)  $f = 433 \text{ MHz}$   
 (3)  $f = 800 \text{ MHz}$   
 (4)  $f = 900 \text{ MHz}$   
 (5)  $f = 1800 \text{ MHz}$

**Fig 15. Maximum power gain as a function of collector-emitter voltage; typical values**



aaa-011107

$V_{CE} = 8\text{ V}; 40\text{ MHz} \leq f \leq 3\text{ GHz}.$

- (1)  $I_C = 10\text{ mA}$
- (2)  $I_C = 15\text{ mA}$

**Fig 16. Input reflection coefficient ( $s_{11}$ ); typical values**



aaa-011108

$V_{CE} = 8\text{ V}; 40\text{ MHz} \leq f \leq 3\text{ GHz}.$

- (1)  $I_C = 10\text{ mA}$
- (2)  $I_C = 15\text{ mA}$

**Fig 17. Output reflection coefficient ( $s_{22}$ ); typical values**

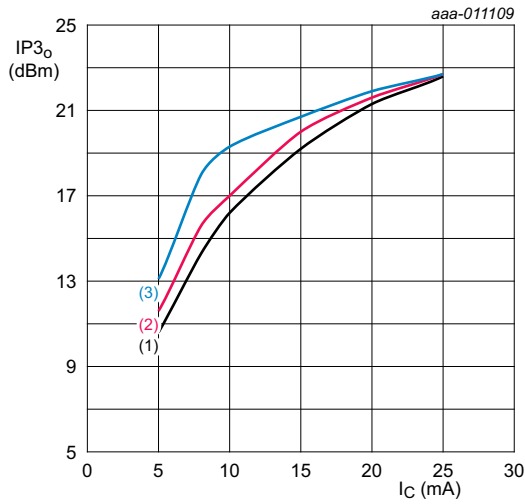

- $V_{CE} = 8\text{ V}; T_{amb} = 25\text{ }^{\circ}\text{C}.$
- (1)  $f_1 = 433\text{ MHz}; f_2 = 434\text{ MHz}$
  - (2)  $f_1 = 900\text{ MHz}; f_2 = 901\text{ MHz}$
  - (3)  $f_1 = 1800\text{ MHz}; f_2 = 1801\text{ MHz}$

**Fig 18. Output third-order intercept point as a function of collector current; typical values**

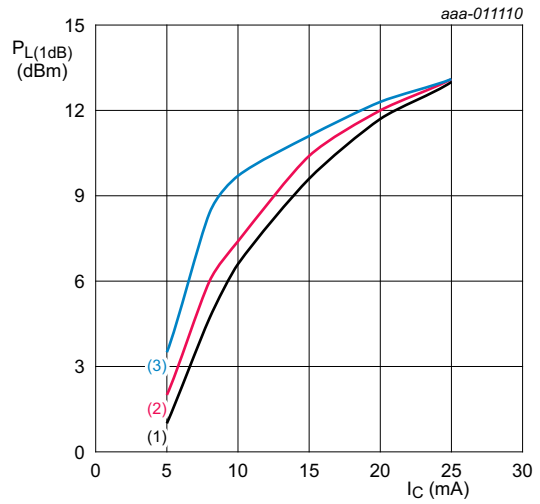

- $V_{CE} = 8\text{ V}; T_{amb} = 25\text{ }^{\circ}\text{C}.$
- (1)  $f = 433\text{ MHz}$
  - (2)  $f = 900\text{ MHz}$
  - (3)  $f = 1800\text{ MHz}$

**Fig 19. Output power at 1 dB gain compression as a function of collector current; typical values**



- $I_C = 15\text{ mA}; T_{amb} = 25\text{ }^{\circ}\text{C}.$
- (1)  $f_1 = 433\text{ MHz}; f_2 = 434\text{ MHz}$
  - (2)  $f_1 = 900\text{ MHz}; f_2 = 901\text{ MHz}$
  - (3)  $f_1 = 1800\text{ MHz}; f_2 = 1801\text{ MHz}$

**Fig 20. Output third-order intercept point as a function of collector-emitter voltage; typical values**

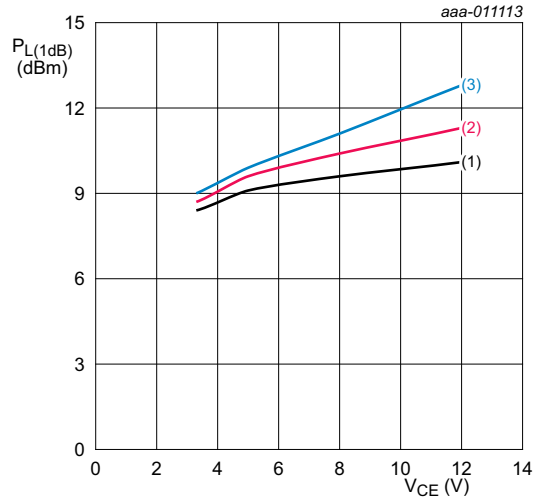

- $I_C = 15\text{ mA}; T_{amb} = 25\text{ }^{\circ}\text{C}.$
- (1)  $f = 433\text{ MHz}$
  - (2)  $f = 900\text{ MHz}$
  - (3)  $f = 1800\text{ MHz}$

**Fig 21. Output power at 1 dB gain compression as a function of collector-emitter voltage; typical values**



$V_{CE} = 8\text{ V}; T_{amb} = 25\text{ }^\circ\text{C}; \Gamma_S = \Gamma_{opt}$   
 (1)  $f = 433\text{ MHz}$   
 (2)  $f = 900\text{ MHz}$   
 (3)  $f = 1800\text{ MHz}$

**Fig 22. Minimum noise figure as a function of collector current; typical values**



$V_{CE} = 8\text{ V}; T_{amb} = 25\text{ }^\circ\text{C}; \Gamma_S = \Gamma_{opt}$   
 (1)  $I_C = 1\text{ mA}$   
 (2)  $I_C = 2\text{ mA}$   
 (3)  $I_C = 3\text{ mA}$   
 (4)  $I_C = 5\text{ mA}$   
 (5)  $I_C = 10\text{ mA}$   
 (6)  $I_C = 15\text{ mA}$   
 (7)  $I_C = 20\text{ mA}$   
 (8)  $I_C = 25\text{ mA}$

**Fig 23. Minimum noise figure as a function of frequency; typical values**



$V_{CE} = 8\text{ V}; 400\text{ MHz} \leq f \leq 2\text{ GHz}.$

- (1)  $I_C = 1\text{ mA}$
- (2)  $I_C = 2\text{ mA}$
- (3)  $I_C = 3\text{ mA}$
- (4)  $I_C = 5\text{ mA}$
- (5)  $I_C = 10\text{ mA}$
- (6)  $I_C = 15\text{ mA}$
- (7)  $I_C = 20\text{ mA}$
- (8)  $I_C = 25\text{ mA}$

**Fig 24. Optimum reflection coefficient ( $\Gamma_{opt}$ ); typical values**

## 10. Application information

More information about the following application example can be found in the application notes. See [Section 5 “Design support”](#).

The following application example can be implemented using the evaluation kit. See [Section 3 “Ordering information”](#) for the order type number.

The following application example can be simulated using the simulation package. See [Section 5 “Design support”](#).

**10.1 Application example: 433 ISM band LNA**

433 ISM band LNA, optimized for low noise.

More detailed information of the application example can be found in the application note: AN11379.

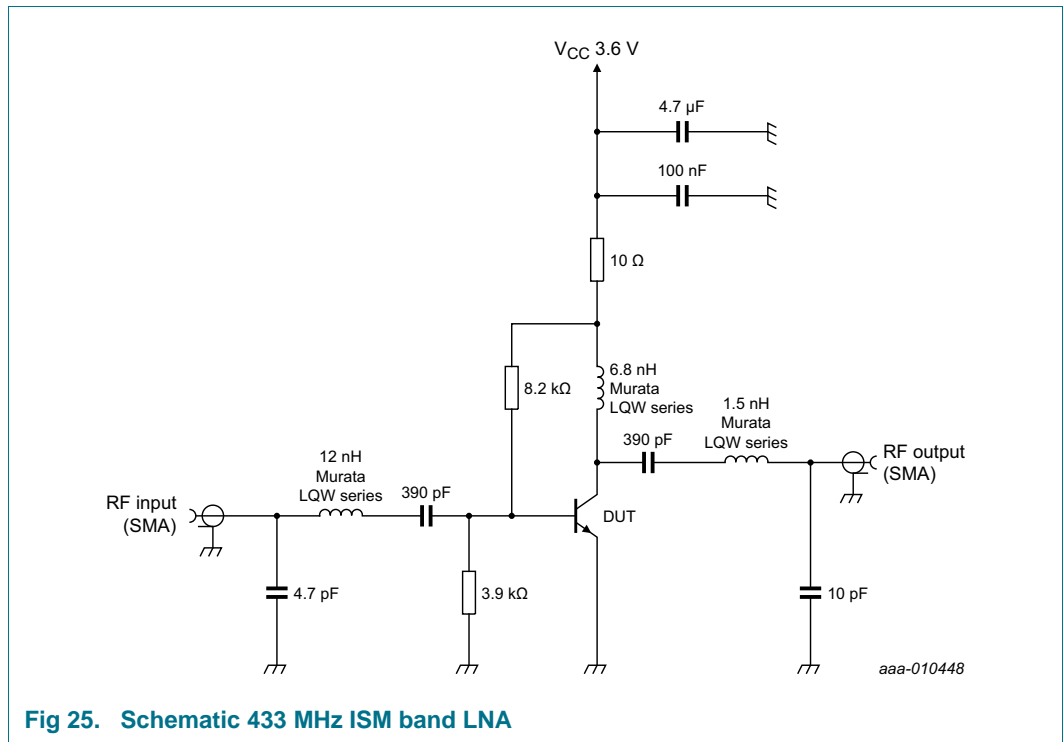

**Fig 25. Schematic 433 MHz ISM band LNA**

**Table 10. Application performance data at 433 MHz**

$I_{CC} = 10 \text{ mA}$ ;  $V_{CC} = 3.6 \text{ V}$

| Symbol           | Parameter                          | Conditions   | Min | Typ | Max | Unit |
|------------------|------------------------------------|--|-----|-----|-----|------|
| $ S_{21} ^2$     | insertion power gain               |  | -   | 17  | -   | dB   |
| NF               | noise figure                       |  | -   | 1.1 | -   | dB   |
| IP3 <sub>o</sub> | output third-order intercept point | $f_1 = 433.1 \text{ MHz}$ ; $f_2 = 433.2 \text{ MHz}$ ;<br>$P_1 = -30 \text{ dBm}$ per carrier | -   | 9   | -   | dBm  |



**10.2 Application example: 866 ISM band LNA**

866 ISM band LNA, optimized for low noise.

More detailed information of the application example can be found in the application note: AN11380.



**Fig 26. Schematic 866 MHz ISM band LNA**

**Table 11. Application performance data at 866 MHz**

$I_{CC} = 10\text{ mA}$ ;  $V_{CC} = 3.6\text{ V}$

| Symbol           | Parameter                          | Conditions  | Min | Typ | Max | Unit |
|------------------|------------------------------------|---|-----|-----|-----|------|
| $ S_{21} ^2$     | insertion power gain               |   | -   | 15  | -   | dB   |
| NF               | noise figure                       |   | -   | 1.1 | -   | dB   |
| IP3 <sub>o</sub> | output third-order intercept point | $f_1 = 866.1\text{ MHz}$ ; $f_2 = 866.2\text{ MHz}$ ;<br>$P_1 = -30\text{ dBm}$ per carrier | -   | 17  | -   | dBm  |

## 11. Package outline

Plastic surface-mounted package; 3 leads

SOT23



Fig 27. Package outline SOT23

## 12. Handling information

### CAUTION



This device is sensitive to ElectroStatic Discharge (ESD). Observe precautions for handling electrostatic sensitive devices.

Such precautions are described in the *ANSI/ESD S20.20*, *IEC/ST 61340-5*, *JESD625-A* or equivalent standards.

## 13. Abbreviations

Table 12. Abbreviations

| Acronym | Description                        |
|---------|------------------------------------|
| AEC     | Automotive Electronics Council     |
| ISM     | Industrial, Scientific and Medical |
| LNA     | Low-Noise Amplifier                |
| MSG     | Maximum Stable Gain                |
| NPN     | Negative-Positive-Negative         |
| SMA     | SubMiniature version A             |

## 14. Revision history

Table 13. Revision history

| Document ID | Release date | Data sheet status  | Change notice | Supersedes |
|-------------|--------------|--------------------|---------------|------------|
| BFU530A v.1 | 20140113     | Product data sheet | -             | -          |

## 15. Legal information

### 15.1 Data sheet status

| Document status <sup>[1][2]</sup> | Product status <sup>[3]</sup> | Definition  |
|-----------------------------------|-------------------------------|---|
| Objective [short] data sheet      | Development                   | This document contains data from the objective specification for product development. |
| Preliminary [short] data sheet    | Qualification                 | This document contains data from the preliminary specification.                       |
| Product [short] data sheet        | Production                    | This document contains the product specification.                                     |

[1] Please consult the most recently issued document before initiating or completing a design.

[2] The term 'short data sheet' is explained in section "Definitions".

[3] The product status of device(s) described in this document may have changed since this document was published and may differ in case of multiple devices. The latest product status information is available on the Internet at URL <http://www.nxp.com>.

### 15.2 Definitions

**Draft** — The document is a draft version only. The content is still under internal review and subject to formal approval, which may result in modifications or additions. NXP Semiconductors does not give any representations or warranties as to the accuracy or completeness of information included herein and shall have no liability for the consequences of use of such information.

**Short data sheet** — A short data sheet is an extract from a full data sheet with the same product type number(s) and title. A short data sheet is intended for quick reference only and should not be relied upon to contain detailed and full information. For detailed and full information see the relevant full data sheet, which is available on request via the local NXP Semiconductors sales office. In case of any inconsistency or conflict with the short data sheet, the full data sheet shall prevail.

**Product specification** — The information and data provided in a Product data sheet shall define the specification of the product as agreed between NXP Semiconductors and its customer, unless NXP Semiconductors and customer have explicitly agreed otherwise in writing. In no event however, shall an agreement be valid in which the NXP Semiconductors product is deemed to offer functions and qualities beyond those described in the Product data sheet.

### 15.3 Disclaimers

**Limited warranty and liability** — Information in this document is believed to be accurate and reliable. However, NXP Semiconductors does not give any representations or warranties, expressed or implied, as to the accuracy or completeness of such information and shall have no liability for the consequences of use of such information. NXP Semiconductors takes no responsibility for the content in this document if provided by an information source outside of NXP Semiconductors.

In no event shall NXP Semiconductors be liable for any indirect, incidental, punitive, special or consequential damages (including - without limitation - lost profits, lost savings, business interruption, costs related to the removal or replacement of any products or rework charges) whether or not such damages are based on tort (including negligence), warranty, breach of contract or any other legal theory.

Notwithstanding any damages that customer might incur for any reason whatsoever, NXP Semiconductors' aggregate and cumulative liability towards customer for the products described herein shall be limited in accordance with the *Terms and conditions of commercial sale* of NXP Semiconductors.

**Right to make changes** — NXP Semiconductors reserves the right to make changes to information published in this document, including without limitation specifications and product descriptions, at any time and without notice. This document supersedes and replaces all information supplied prior to the publication hereof.

**Applications** — Applications that are described herein for any of these products are for illustrative purposes only. NXP Semiconductors makes no representation or warranty that such applications will be suitable for the specified use without further testing or modification.

Customers are responsible for the design and operation of their applications and products using NXP Semiconductors products, and NXP Semiconductors accepts no liability for any assistance with applications or customer product design. It is customer's sole responsibility to determine whether the NXP Semiconductors product is suitable and fit for the customer's applications and products planned, as well as for the planned application and use of customer's third party customer(s). Customers should provide appropriate design and operating safeguards to minimize the risks associated with their applications and products.

NXP Semiconductors does not accept any liability related to any default, damage, costs or problem which is based on any weakness or default in the customer's applications or products, or the application or use by customer's third party customer(s). Customer is responsible for doing all necessary testing for the customer's applications and products using NXP Semiconductors products in order to avoid a default of the applications and the products or of the application or use by customer's third party customer(s). NXP does not accept any liability in this respect.

**Limiting values** — Stress above one or more limiting values (as defined in the Absolute Maximum Ratings System of IEC 60134) will cause permanent damage to the device. Limiting values are stress ratings only and (proper) operation of the device at these or any other conditions above those given in the Recommended operating conditions section (if present) or the Characteristics sections of this document is not warranted. Constant or repeated exposure to limiting values will permanently and irreversibly affect the quality and reliability of the device.

**Terms and conditions of commercial sale** — NXP Semiconductors products are sold subject to the general terms and conditions of commercial sale, as published at <http://www.nxp.com/profile/terms>, unless otherwise agreed in a valid written individual agreement. In case an individual agreement is concluded only the terms and conditions of the respective agreement shall apply. NXP Semiconductors hereby expressly objects to applying the customer's general terms and conditions with regard to the purchase of NXP Semiconductors products by customer.

**No offer to sell or license** — Nothing in this document may be interpreted or construed as an offer to sell products that is open for acceptance or the grant, conveyance or implication of any license under any copyrights, patents or other industrial or intellectual property rights.

**Export control** — This document as well as the item(s) described herein may be subject to export control regulations. Export might require a prior authorization from competent authorities.

**Quick reference data** — The Quick reference data is an extract of the product data given in the Limiting values and Characteristics sections of this document, and as such is not complete, exhaustive or legally binding.

**Suitability for use in automotive applications** — This NXP Semiconductors product has been qualified for use in automotive applications. Unless otherwise agreed in writing, the product is not designed, authorized or warranted to be suitable for use in life support, life-critical or safety-critical systems or equipment, nor in applications where failure or malfunction of an NXP Semiconductors product can reasonably be expected to result in personal injury, death or severe property or environmental damage. NXP Semiconductors and its suppliers accept no liability for inclusion and/or use of NXP Semiconductors products in such equipment or applications and therefore such inclusion and/or use is at the customer's own risk.

**Translations** — A non-English (translated) version of a document is for reference only. The English version shall prevail in case of any discrepancy between the translated and English versions.

## 15.4 Trademarks

Notice: All referenced brands, product names, service names and trademarks are the property of their respective owners.

## 16. Contact information

---

For more information, please visit: <http://www.nxp.com>

For sales office addresses, please send an email to: [salesaddresses@nxp.com](mailto:salesaddresses@nxp.com)

## 17. Contents

|           |   |           |
|-----------|---|-----------|
| <b>1</b>  | <b>Product profile</b> . . . . .                  | <b>1</b>  |
| 1.1       | General description . . . . .                     | 1         |
| 1.2       | Features and benefits . . . . .                   | 1         |
| 1.3       | Applications . . . . .                            | 1         |
| 1.4       | Quick reference data . . . . .                    | 1         |
| <b>2</b>  | <b>Pinning information</b> . . . . .              | <b>2</b>  |
| <b>3</b>  | <b>Ordering information</b> . . . . .             | <b>2</b>  |
| <b>4</b>  | <b>Marking</b> . . . . .                          | <b>2</b>  |
| <b>5</b>  | <b>Design support</b> . . . . .                   | <b>3</b>  |
| <b>6</b>  | <b>Limiting values</b> . . . . .                  | <b>3</b>  |
| <b>7</b>  | <b>Recommended operating conditions</b> . . . . . | <b>3</b>  |
| <b>8</b>  | <b>Thermal characteristics</b> . . . . .          | <b>4</b>  |
| <b>9</b>  | <b>Characteristics</b> . . . . .                  | <b>4</b>  |
| 9.1       | Graphs . . . . .                                  | 7         |
| <b>10</b> | <b>Application information</b> . . . . .          | <b>15</b> |
| 10.1      | Application example: 433 ISM band LNA . . . . .   | 16        |
| 10.2      | Application example: 866 ISM band LNA . . . . .   | 17        |
| <b>11</b> | <b>Package outline</b> . . . . .                  | <b>18</b> |
| <b>12</b> | <b>Handling information</b> . . . . .             | <b>19</b> |
| <b>13</b> | <b>Abbreviations</b> . . . . .                    | <b>19</b> |
| <b>14</b> | <b>Revision history</b> . . . . .                 | <b>19</b> |
| <b>15</b> | <b>Legal information</b> . . . . .                | <b>20</b> |
| 15.1      | Data sheet status . . . . .                       | 20        |
| 15.2      | Definitions . . . . .                             | 20        |
| 15.3      | Disclaimers . . . . .                             | 20        |
| 15.4      | Trademarks . . . . .                              | 21        |
| <b>16</b> | <b>Contact information</b> . . . . .              | <b>21</b> |
| <b>17</b> | <b>Contents</b> . . . . .                         | <b>22</b> |

Please be aware that important notices concerning this document and the product(s) described herein, have been included in section 'Legal information'.

© NXP B.V. 2014.

All rights reserved.

For more information, please visit: <http://www.nxp.com>

For sales office addresses, please send an email to: [salesaddresses@nxp.com](mailto:salesaddresses@nxp.com)

Date of release: 13 January 2014

Document identifier: BFU530A



Компания «ЭлектроПласт» предлагает заключение долгосрочных отношений при поставках импортных электронных компонентов на взаимовыгодных условиях!

Наши преимущества:

- Оперативные поставки широкого спектра электронных компонентов отечественного и импортного производства напрямую от производителей и с крупнейших мировых складов;
- Поставка более 17-ти миллионов наименований электронных компонентов;
- Поставка сложных, дефицитных, либо снятых с производства позиций;
- Оперативные сроки поставки под заказ (от 5 рабочих дней);
- Экспресс доставка в любую точку России;
- Техническая поддержка проекта, помощь в подборе аналогов, поставка прототипов;
- Система менеджмента качества сертифицирована по Международному стандарту ISO 9001;
- Лицензия ФСБ на осуществление работ с использованием сведений, составляющих государственную тайну;
- Поставка специализированных компонентов (Xilinx, Altera, Analog Devices, Intersil, Interpoint, Microsemi, Aeroflex, Peregrine, Syfer, Eurofarad, Texas Instrument, Miteq, Cobham, E2V, MA-COM, Hittite, Mini-Circuits, General Dynamics и др.);

Помимо этого, одним из направлений компании «ЭлектроПласт» является направление «Источники питания». Мы предлагаем Вам помощь Конструкторского отдела:

- Подбор оптимального решения, техническое обоснование при выборе компонента;
- Подбор аналогов;
- Консультации по применению компонента;
- Поставка образцов и прототипов;
- Техническая поддержка проекта;
- Защита от снятия компонента с производства.



#### Как с нами связаться

**Телефон:** 8 (812) 309 58 32 (многоканальный)

**Факс:** 8 (812) 320-02-42

**Электронная почта:** [org@eplast1.ru](mailto:org@eplast1.ru)

**Адрес:** 198099, г. Санкт-Петербург, ул. Калинина, дом 2, корпус 4, литера А.