

Photomicrosensor (Transmissive) EE-SX3162/3163/3164-P Series EE-SX4162/4163/4164-P Series EE-5002 1M

Slot / Connector Type

- Photo IC output (Dark-ON / Light ON)
- Connector with strong lock manufactured by JST. Mates with GHR-03.
- Mounted with M2 screws
- Models available for 5-V or 12-V power supply.
- Zener diode mounted for greater noise immunity (EE-SX3162-P1-Z and EE-SX4162-P1-Z only).
- Connector with cable (Order Separately) is available. EE-5002 1M (Refer to page 5.)



 Be sure to read *Safety Precautions* on page 3.

Features

Models with Connectors Eliminate the Need for a Separate PCB
All-in-One Structure Facilitates Downsizing

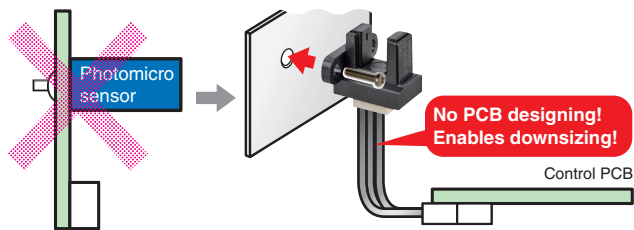

Models Available for Mounting on X, Y, and Z Axes

Models with connectors are available with different mounting directions.



Application



Office Automation Equipment
(Copier, Printer)



Amusement Equipment



Home Appliances (Air Cleaner)



Vending Machine, ATM

Ordering Information

Photomicrosensor

Appearance	Sensing method	Connecting method	Sensing distance	Aperture size (H x W) (mm)	Output type	Power supply voltage	Output configuration	Model
Side mounting 	Transmissive (slot type)	Connector	5 mm (Slot width)	Emitter 1.4 x 1.4 Detector 1.4 x 0.5	Photo IC	12 VDC	Dark-ON	EE-SX3162-P1 EE-SX3162-P1-Z
L-shaped mounting 							Light-ON	EE-SX4162-P1 EE-SX4162-P1-Z
							5 VDC	Dark-ON
Light-ON								EE-SX4162-P2
Horizontal mounting 						12 VDC	Dark-ON	EE-SX3163-P1 EE-SX4163-P1
							Light-ON	EE-SX4163-P2
						5 VDC	Dark-ON	EE-SX3163-P2
							Light-ON	EE-SX4163-P2
						12 VDC	Dark-ON	EE-SX3164-P1 EE-SX4164-P1
							Light-ON	EE-SX4164-P2
						5 VDC	Dark-ON	EE-SX3164-P2
							Light-ON	EE-SX4164-P2

Ratings, Characteristics and Exterior Specifications

Absolute Maximum Ratings (Ta = 25°C)

Item	Symbol	Rated value		Unit	Remarks
		EE-SX3162-P1 EE-SX3162-P1-Z EE-SX3163-P1 EE-SX3164-P1 EE-SX4162-P1 EE-SX4162-P1-Z EE-SX4163-P1 EE-SX4164-P1	EE-SX3162-P2 EE-SX3163-P2 EE-SX3164-P2 EE-SX4162-P2 EE-SX4163-P2 EE-SX4164-P2		
Power supply voltage	V _{CC}	13.2 DC	5.5 DC	V	—
Output voltage	V _{OUT}	13.2		V	—
Output current	I _{OUT}	16		mA	—
Permissible output dissipation	P _{OUT}	80		mW	—*
Operating temperature	T _{opr}	-20 to +85		°C	—*
Storage temperature	T _{stg}	-30 to +85		°C	—*

* Even if the specified conditions are met, perform derating of the voltage and current as required by the temperature rating diagram. Also, do not expose the product to freezing or condensation.

Exterior Specifications

Appearance	Side mounting	L-shaped mounting	Horizontal mounting
Item	EE-SX3162-P1 EE-SX3162-P1-Z EE-SX4162-P1 EE-SX4162-P1-Z EE-SX3162-P2 EE-SX4162-P2	EE-SX3163-P1 EE-SX4163-P1 EE-SX3163-P2 EE-SX4163-P2	EE-SX3164-P1 EE-SX4164-P1 EE-SX3164-P2 EE-SX4164-P2
Connecting method	Connector		
Weight	Approx. 1.2 g	Approx. 1.4 g	Approx. 1.1 g
Material	Case	Polybutylene terephthalate (PBT)	
	Emitter and receiver sections	Polyphenylene sulfide (PPS)	

Electrical and Optical Characteristics (Ta = 25°C)

Item	Symbol	Rated value	
		12 VDC model	5 VDC model
		Dark-ON	EE-SX3162-P1 EE-SX3162-P1-Z EE-SX3163-P1 EE-SX3164-P1
Light-ON	EE-SX4162-P1 EE-SX4162-P1-Z EE-SX4163-P1 EE-SX4164-P1	EE-SX4162-P2 EE-SX4163-P2 EE-SX4164-P2	
Power supply voltage	V _{CC}	10.8 to 13.2VDC	4.5 to 5.5 VDC
Current consumption	I _{CC}	25 mA max. (With and without incident)	
Low-level output voltage	V _{OL}	0.3 V max. (I _{OUT} =16 mA) (Dark-ON: without incident, Light-ON: with incident)	
High-level output voltage	V _{OH}	(V _{CC} ×0.9 V max. (V _{OUT} =V _{CC} , R _L =47 kΩ)) (Dark-ON: with incident, Light-ON: without incident)	
Response frequency	f	3 kHz min. (V _{OUT} =V _{CC} , I _{OUT} =16 mA *1)	
		1 kHz min. (V _{OUT} =V _{CC} , I _{OUT} =16 mA *1, *2)	

*1. The value of the response frequency is measured by rotating the disk as shown below.

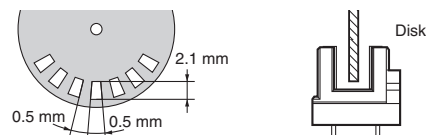

*2. Only with models ending in -Z.

Engineering Data (Reference value)

Fig 1. Output Allowable Dissipation vs. Ambient Temperature Characteristics



Fig 2. Sensing Position Characteristics (Typical)



Fig 3. Sensing Position Characteristics (Typical)

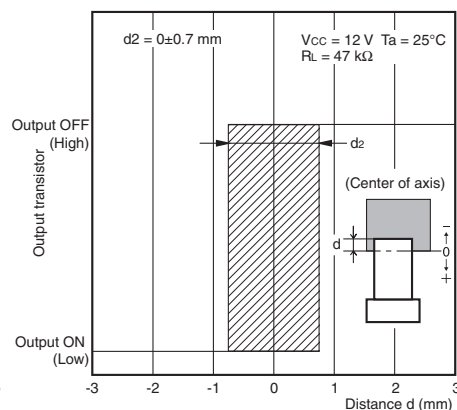

Safety Precautions

To ensure safe operation, be sure to read and follow the Instruction Manual provided with the Sensor.

CAUTION

This product is not designed or rated for ensuring safety of persons either directly or indirectly. Do not use it for such purposes.



Precautions for Correct Use

Do not use the product in atmospheres or environments that exceed product ratings. Dispose of this product as industrial waste.

Precautions for Safe Use

Do not use the product with a voltage or current that exceeds the rated range.

Applying a voltage or current that is higher than the rated range may result in explosion or fire.

Do not miswire such as the polarity of the power supply voltage.

Otherwise the product may be damaged or it may burn.

Do not short-circuit the load.

Otherwise explosion or burning may occur.

This product does not resist water. Do not use the product in places where water or oil may be sprayed onto the product.

Dimensions and Internal Circuit

(Unit: mm)

Photomicrosensor

- EE-SX3162-P1
- EE-SX3162-P1-Z
- EE-SX4162-P1
- EE-SX4162-P1-Z
- EE-SX3162-P2
- EE-SX4162-P2



Aperture size (H x W)

Emitter	Detector
1.4 x 1.4	1.4 x 0.5



Recommended Mating Connectors:
JST (Japan Solderless Terminal) GHR-03

Unless otherwise specified, the tolerances are as shown below.

Dimensions	Tolerance
3 mm max.	±0.2
3 < mm ≤ 6	±0.24
6 < mm ≤ 10	±0.29
10 < mm ≤ 18	±0.35
18 < mm ≤ 30	±0.42

Note: Dimensions in parentheses are for reference only.

Internal Circuit

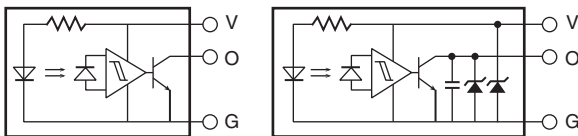

Terminal No.	Name
(1)	Ground (GND)
(2)	Output (OUT)
(3)	Power supply (Vcc)

Note: Only with models ending in -Z.

- EE-SX3163-P1
- EE-SX4163-P1
- EE-SX3163-P2
- EE-SX4163-P2



Aperture size (H x W)

Emitter	Detector
1.4 x 1.4	1.4 x 0.5

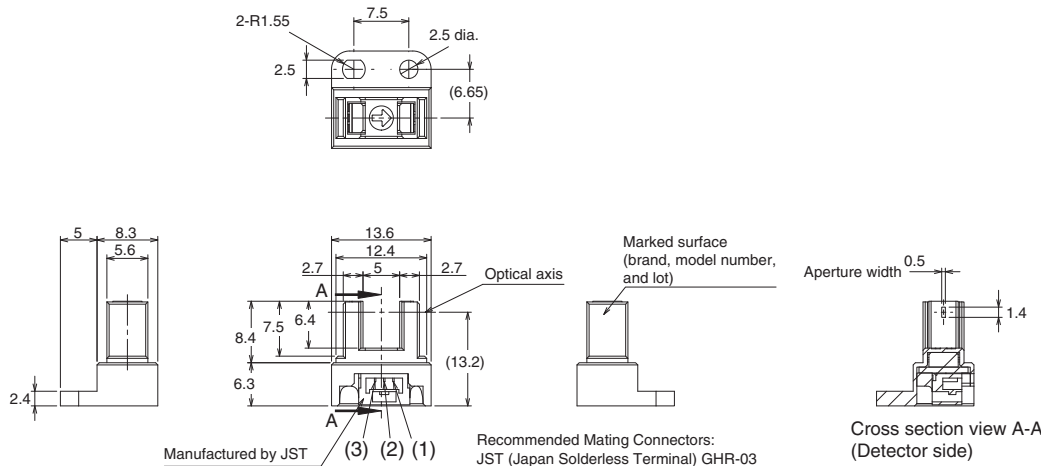

Recommended Mating Connectors:
JST (Japan Solderless Terminal) GHR-03

Unless otherwise specified, the tolerances are as shown below.

Dimensions	Tolerance
3 mm max.	±0.2
3 < mm ≤ 6	±0.24
6 < mm ≤ 10	±0.29
10 < mm ≤ 18	±0.35
18 < mm ≤ 30	±0.42

Note: Dimensions in parentheses are for reference only.

Internal Circuit

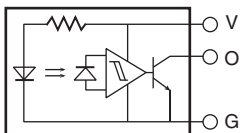

Terminal No.	Name
(1)	Ground (GND)
(2)	Output (OUT)
(3)	Power supply (Vcc)

EE-SX3162/3163/3164-P Series EE-SX4162/4163/4164-P Series EE-5002 1M

EE-SX3164-P1
 EE-SX4164-P1
 EE-SX3164-P2
 EE-SX4164-P2



Aperture size (H x W)

Emitter	Detector
1.4 x 1.4	1.4 x 0.5

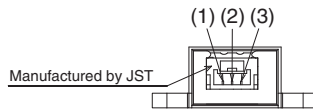

Recommended Mating Connectors:
 JST (Japan Solderless Terminal) GHR-03

Internal Circuit



Terminal No.	Name
(1)	Ground (GND)
(2)	Output (OUT)
(3)	Power supply (Vcc)

Unless otherwise specified, the tolerances are as shown below.

Dimensions	Tolerance
3 mm max.	±0.2
3 < mm ≤ 6	±0.24
6 < mm ≤ 10	±0.29
10 < mm ≤ 18	±0.35
18 < mm ≤ 30	±0.42

Note: Dimensions in parentheses are for reference only.

Connector with cable (Order Separately)

EE-5002 1M



No.	Name	Model/ Specifications	Quantity	Manufacturer
(1)	Connector, HS for 101-150 harness	GHR-03V-S	1	JST
(2)	Connector, CT for 101-150 harness	SSHL-002TP0.2	3	JST
(3)	Lead wires	UL1061 AWG26	3	—

Wiring

Connector circuit number	Lead-wire color
1	Blue
2	Black
3	Brown

- Application examples provided in this document are for reference only. In actual applications, confirm equipment functions and safety before using the product.
- Consult your OMRON representative before using the product under conditions which are not described in the manual or applying the product to nuclear control systems, railroad systems, aviation systems, vehicles, combustion systems, medical equipment, amusement machines, safety equipment, and other systems or equipment that may have a serious influence on lives and property if used improperly. Make sure that the ratings and performance characteristics of the product provide a margin of safety for the system or equipment, and be sure to provide the system or equipment with double safety mechanisms.

Note: Do not use this document to operate the Unit.



Компания «ЭлектроПласт» предлагает заключение долгосрочных отношений при поставках импортных электронных компонентов на взаимовыгодных условиях!

Наши преимущества:

- Оперативные поставки широкого спектра электронных компонентов отечественного и импортного производства напрямую от производителей и с крупнейших мировых складов;
- Поставка более 17-ти миллионов наименований электронных компонентов;
- Поставка сложных, дефицитных, либо снятых с производства позиций;
- Оперативные сроки поставки под заказ (от 5 рабочих дней);
- Экспресс доставка в любую точку России;
- Техническая поддержка проекта, помощь в подборе аналогов, поставка прототипов;
- Система менеджмента качества сертифицирована по Международному стандарту ISO 9001;
- Лицензия ФСБ на осуществление работ с использованием сведений, составляющих государственную тайну;
- Поставка специализированных компонентов (Xilinx, Altera, Analog Devices, Intersil, Interpoint, Microsemi, Aeroflex, Peregrine, Syfer, Eurofarad, Texas Instrument, Miteq, Cobham, E2V, MA-COM, Hittite, Mini-Circuits, General Dynamics и др.);

Помимо этого, одним из направлений компании «ЭлектроПласт» является направление «Источники питания». Мы предлагаем Вам помощь Конструкторского отдела:

- Подбор оптимального решения, техническое обоснование при выборе компонента;
- Подбор аналогов;
- Консультации по применению компонента;
- Поставка образцов и прототипов;
- Техническая поддержка проекта;
- Защита от снятия компонента с производства.



Как с нами связаться

Телефон: 8 (812) 309 58 32 (многоканальный)

Факс: 8 (812) 320-02-42

Электронная почта: org@eplast1.ru

Адрес: 198099, г. Санкт-Петербург, ул. Калинина, дом 2, корпус 4, литера А.