

LTM2886
**SPI/Digital or I²C μModule Isolator with
 Fixed ±5V and Adjustable 5V Regulated Power**
DESCRIPTION

Demonstration circuit 1790A is a serial peripheral interface bus (SPI) or inter-IC bus (I²C) μModule™ isolator with fixed ±5V and adjustable 5V regulated power featuring the LTM[®]2886. The demo circuit features an EMI optimized circuit configuration and printed circuit board layout. All components are integrated into the μModule isolator. The demo circuit operates from a single external supply on V_{CC}. The part generates output voltages on V_{CC2}, which

may be adjusted by an external programming resistor, and fixed voltages on V⁺ and V⁻. It communicates all necessary signaling across the isolation barrier through LTC's isolator μModule technology.

Design files for this circuit board are available at <http://www.linear.com/demo>

LT, LT, LTC, LTM, μModule, Linear Technology and the Linear logo are registered trademarks of Linear Technology Corporation. All other trademarks are the property of their respective owners.

PERFORMANCE SUMMARY (T_A = 25°C)

SYMBOL	PARAMETER	CONDITIONS	MIN	TYP	MAX	UNITS
V _{CC}	Input Supply Range	LTM2886-5	4.5	5	5.5	V
		LTM2886-3	3.0	3	3.6	V
V _{CC2}	Regulated Output Voltage		4.75	5	5.25	V
	Adjustable Output Voltage Range		3.0		5.5	V
	Current Limit		100			mA
V ⁺	Regulated Output Voltage		4.75	5	5.25	V
	Current Limit		100			mA
V ⁻	Regulated Output Voltage		-4.75	-5	-5.25	V
	Current Limit		100			mA
f _{MAX}	Maximum Data Rate	DI1 → O1, Ix → DOx, C _L = 15pF	20			MHz
		LTM2886-S, Bidirectional Communication	4			MHz
		LTM2886-S, Unidirectional Communication	8			MHz
		LTM2886-I	400			kHz
V _{IORM}	Maximum Working Insulation Voltage	GND to GND2	560			V _{DC}
			400			V _{RMS}
		Common Mode Transient Immunity	30			kV/μs

OPERATING PRINCIPLES

The LTM2886 contains an isolated DC/DC conversion system, including a secondary quadrupler, with multiple LDOs to deliver power to the three output voltage rails from V_{CC}. Isolation is maintained by the separation of GND and GND2 where significant operating voltages and transients can exist without affecting the operation of the

LTM2886. The logic side ON pin enables or shuts down the LTM2886. All logic side signals are referenced to the logic supply pin V_L. The LTM2886 is available in two data bus configurations, SPI (-S) or I²C (-I), and with two input voltage ranges, 3.0 to 3.6 volts (-3) or 4.5 to 5.5 volts (-5).

OPERATING PRINCIPLES

SPI signaling is controlled by the logic inputs \overline{CS} , SDI, and SCK. \overline{SDOE} controls the SDO output and is normally connected to \overline{CS} . The corresponding isolated side output signals are $\overline{CS2}$, SDI2, and SCK2. SDO2 is the isolated side SPI data input. All of the SPI communication channels may be used as generic digital I/O.

I²C signaling is controlled by the logic inputs SDA and SCL, corresponding to SDA2 and SCL2 on the isolated side. The SCL channel is unidirectional supporting master mode only I²C communication. SCL2 output is standard CMOS push-pull drive. SDA signaling is bidirectional, and includes an internal current source pull-up on SDA2 supporting up to 200pF of load capacitance.

Demo circuit 1790A is available in four configurations supporting all versions of the LTM2886. Table 1 details the demo circuit configurations.

Table 1.

DEMO CIRCUIT	INPUT VOLTAGE	COMMUNICATION
DC1790A-A	3.0V to 3.6V	SPI/Digital
DC1790A-B	4.5V to 5.5V	SPI/Digital
DC1790A-C	3.0V to 3.6V	I ² C
DC1790A-D	4.5V to 5.5V	I ² C

The demo circuit has been designed and optimized for low RF emissions. To this end some features of the LTM2886 are not available for evaluation on the demo circuit. The logic supply voltage V_L is tied to V_{CC} on the demo circuit, and the ON pin is not available on the input pin header, but may be controlled by jumper JP1. EMI mitigation techniques used include the following.

1. Four layer PCB, allowing for isolated side to logic side “bridge” capacitor. The bridge capacitor is formed between an inner layer of floating copper which overlaps the logic side and isolated side ground planes. This

structure creates two series capacitors, each with approximately .008” of insulation, supporting the full dielectric withstand rating of 2500V_{RMS}. The bridge capacitor provides a low impedance return path for injected currents due to parasitic capacitances of the LTM2886’s signal and power isolating elements.

2. Discrete bridge capacitors (C3, C4) mounted between GND2 and GND. The discrete capacitors provide additional attenuation at frequencies below 400MHz. Capacitors are safety rated type Y2, manufactured by Murata, part number GA342QR7GF471KW01L.
3. Board/ground plane size has been minimized. This reduces the dipole antenna formed between the logic side and isolated side ground planes.
4. Top signal routing and ground floods have been optimized to reduce signal loops, minimizing differential mode radiation.
5. Common mode filtering is integrated into the input and output pin headers. Filtering helps to reduce emissions caused by conducted noise and minimizes the effects of cabling to common mode emissions.
6. A combination of low ESL and high ESR decoupling is used. A low ESL ceramic capacitor is located close to the module minimizing high frequency noise conduction. A high ESR tantalum capacitor is included to minimize board resonances and prevent voltage spikes due to hot plugging of the supply voltage.

EMI performance is shown in Figure 1, measured using a Gigahertz Transverse Electromagnetic (GTEM) cell and method detailed in IEC 61000-4-20, “Testing and Measurement Techniques – Emission and Immunity Testing in Transverse Electromagnetic Waveguides”.

OPERATING PRINCIPLES

LTM2886 Low EMI Demo Board Radiated Emissions

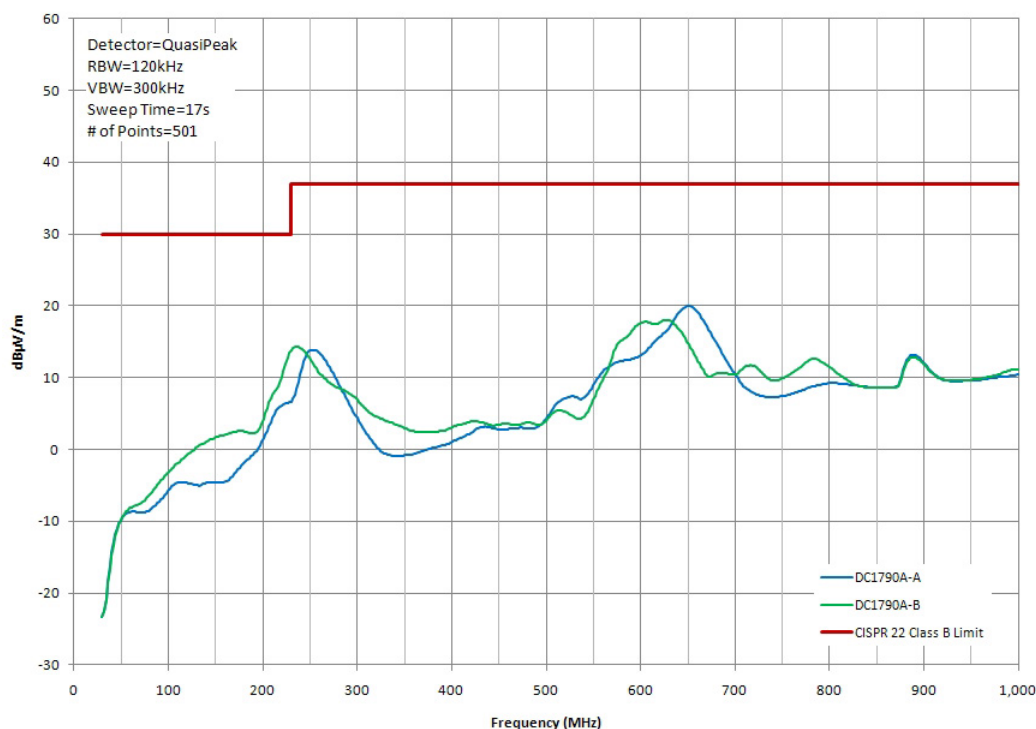

Figure 1. DC1790A Radiated Emissions

The demo circuit includes provisions for programming the V_{CC2} voltage rail. Resistor R5 allows the V_{CC2} power rail to be reduced from its nominal operating voltage of 5V. The formula presented in Table 2 allows selection of the appropriate resistor value.

Table 2.

VOLTAGE RAIL	RESISTOR TO REDUCE OUTPUT
V_{CC2}	$R5 = 61.9k \cdot (V_{CC2} - 1.22) / (5 - V_{CC2})$

QUICK START PROCEDURE

Demonstration circuit 1790A is easy to set up and evaluate the performance of the LTM2886. Refer to Figure 2 for proper measurement equipment setup and follow the procedure below.

NOTE: When measuring the input or output voltage ripple or high speed signals, care must be taken to avoid a long ground lead on the oscilloscope probe.

1. Install JP1 in the ON (default) position.
2. With power off, connect the input power supply to V_{CC} and GND on pin header J1.

3. Turn on the power at the input.

NOTE: Make sure that the input voltage does not exceed 6V.

4. Check for the proper output voltages. V_{CC2} = 5V, V⁺ = 5V, and V⁻ = -5V on pin header J2.

5. Once the proper output voltages are established, connect signals to J1 and J2 pin headers as appropriate. The header pin names and locations are detailed on the demo board silkscreen below the pin headers.

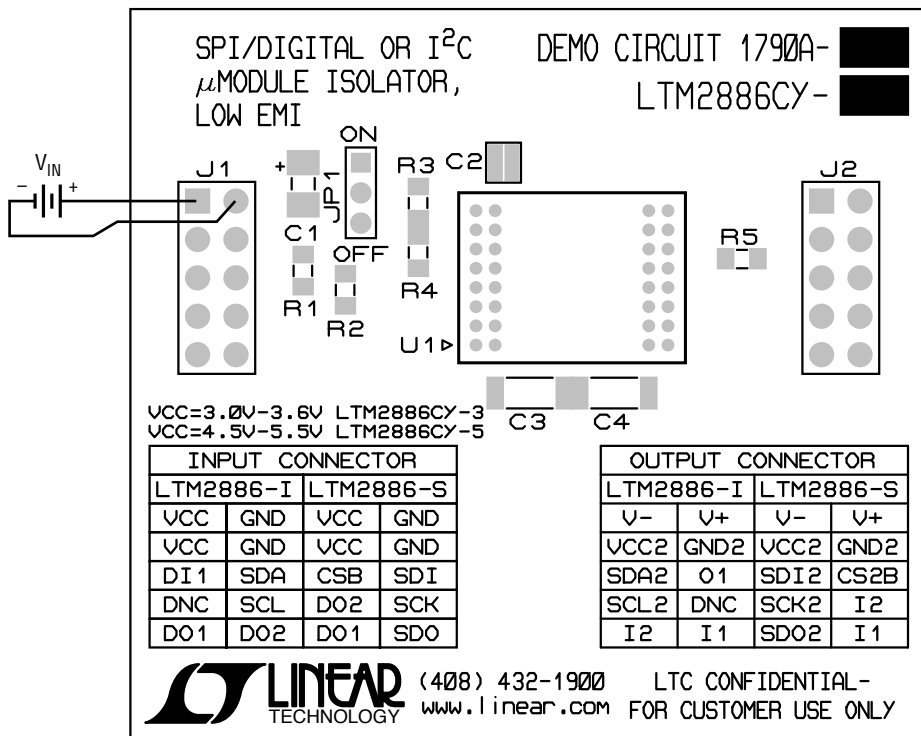
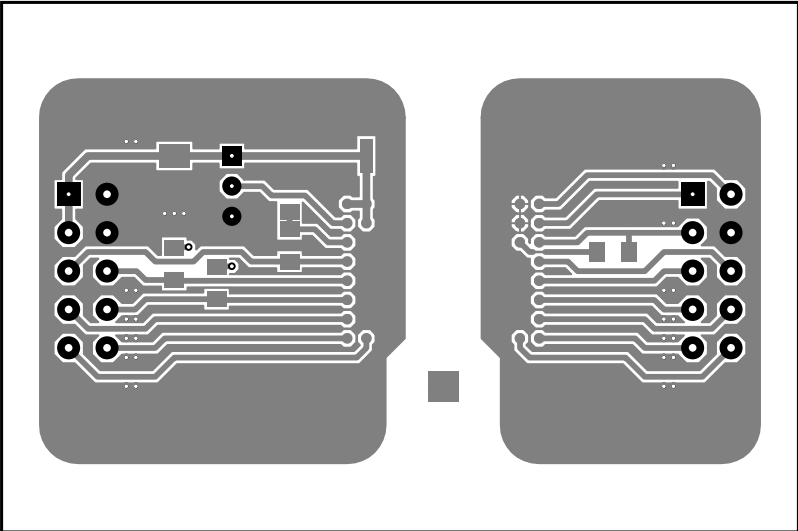

Figure 2. Demo Board Setup

PCB LAYOUT

Layer 1. Top Layer



Layer 2. Ground Plane

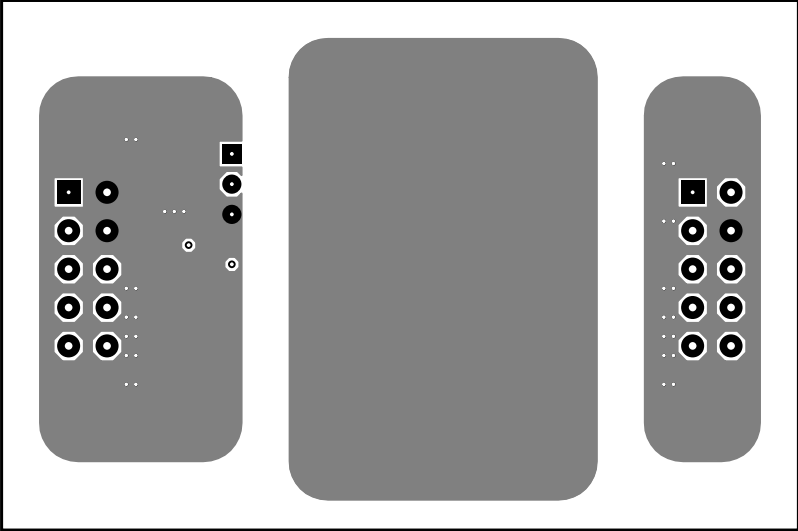

PCB LAYOUT

Layer 3. Signal Layer

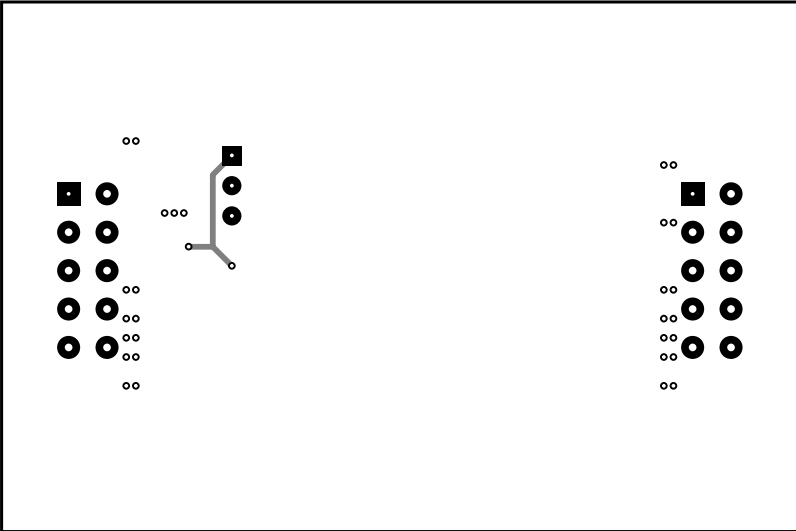

Layer 4. Bottom Layer

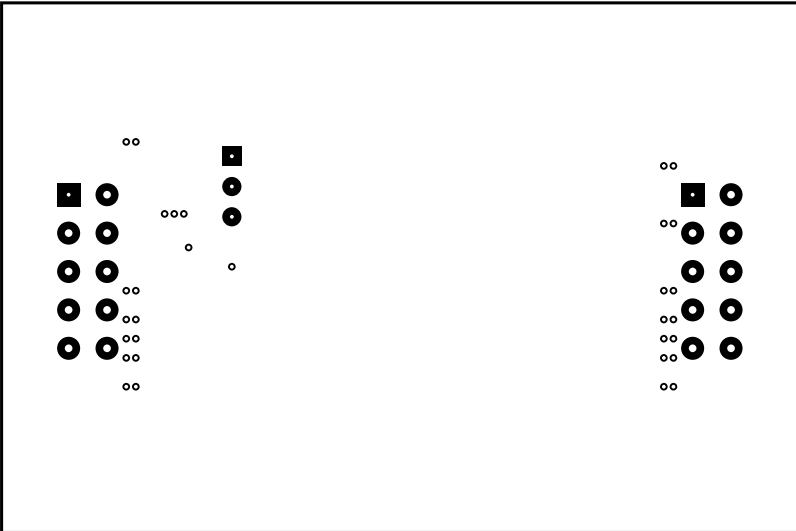

PARTS LIST

ITEM	QTY	REFERENCE	PART DESCRIPTION	MANUFACTURER/PART NUMBER
Required Circuit Components				
1	1	U1	-A I.C., LTM2886CY-3S -B I.C., LTM2886CY-5S -C I.C., LTM2886CY-3I -D I.C., LTM2886CY-5I	LINEAR LTM2886CY-3S#PBF LINEAR LTM2886CY-5S#PBF LINEAR LTM2886CY-3I#PBF LINEAR LTM2886CY-5I#PBF
Hardware/Components (For Demo Board Only)				
2	1	C1	CAP, TANT 10 μ F 10V 20% TAJA	AVX TAJA106M010RNJ
3	1	C2	CAP, CER 1 μ F 10V 20% 0508	MURATA LLL219R71A105MA01L
4	2	C3, C4	CAP, CER 470pF 250Vac 10% 1808	MURATA GA342QR7GF471KW01L
5	2	J1, J2	0.1" DOUBLE ROW HEADER, 5 \times 2 PIN	SAMTEC TSW-105-22-G-D
6	2	J1, J2	0.1" FERRITE PLATE, 5 \times 2 HOLE	FAIR RITE 2644247101
7	1	JP1	2mm SINGLE ROW HEADER, 3-PIN	SAMTEC TMM-103-02-L-S
8	1	JP1	SHUNT	SAMTEC 2SN-BK-G
9	1	R1	-C RES., CHIP 10k Ω 1% 0805 -D RES., CHIP 10k Ω 1% 0805	YAGEO RC0805FR-0710KL YAGEO RC0805FR-0710KL
10	1	R2	-C RES., CHIP 10k Ω 1% 0805 -D RES., CHIP 10k Ω 1% 0805	YAGEO RC0805FR-0710KL YAGEO RC0805FR-0710KL
11	1	R3	-C RES., CHIP 0 0805 -D RES., CHIP 0 0805	YAGEO RC0805FR-070RL YAGEO RC0805FR-070RL
12	1	R4	-A RES., CHIP 0 0805 -B RES., CHIP 0 0805	YAGEO RC0805FR-070RL YAGEO RC0805FR-070RL

DEMO MANUAL DC1790A

SCHEMATIC DIAGRAM DC1790A-A/B

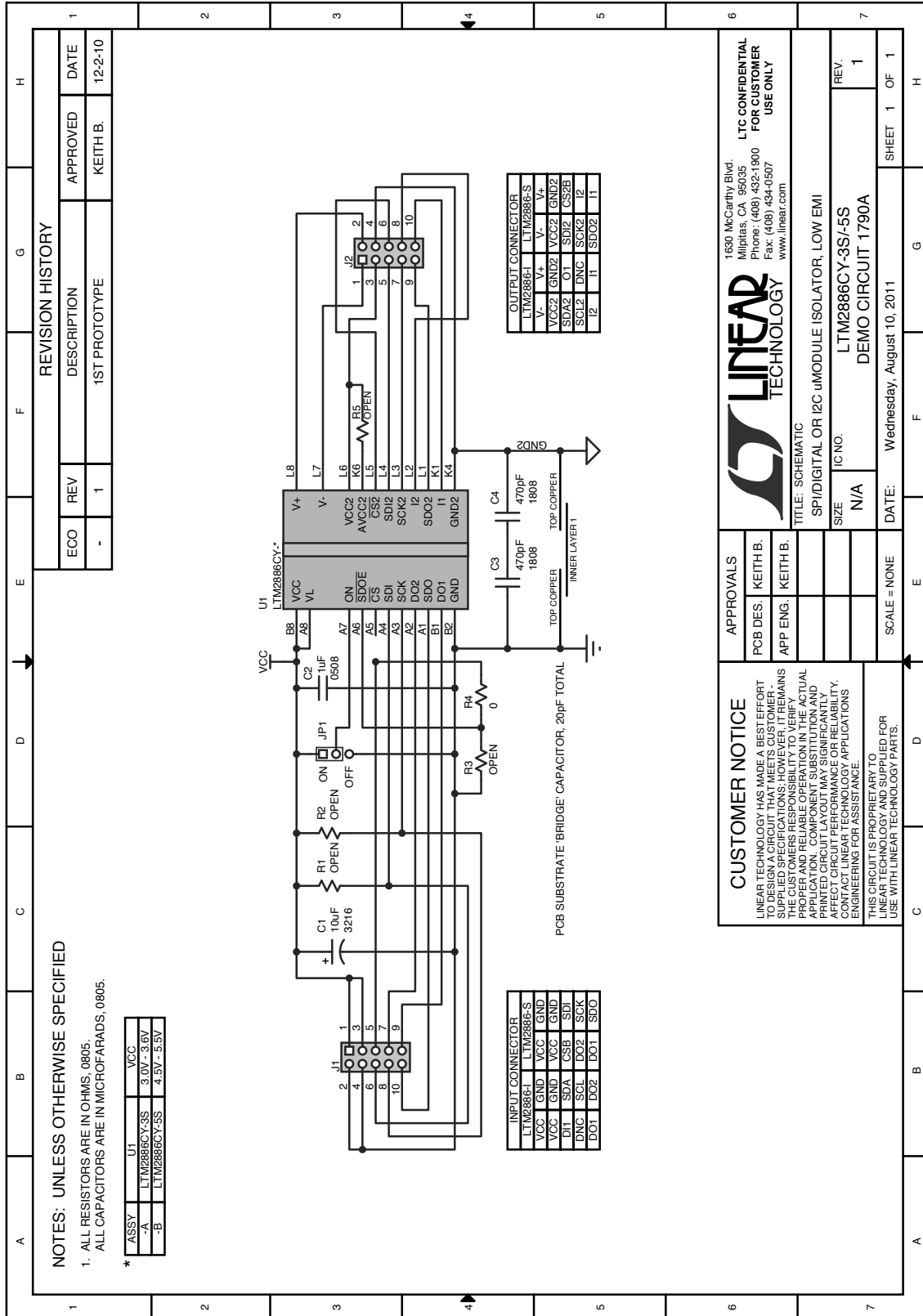

SCHEMATIC DIAGRAM DC1790A-C/D

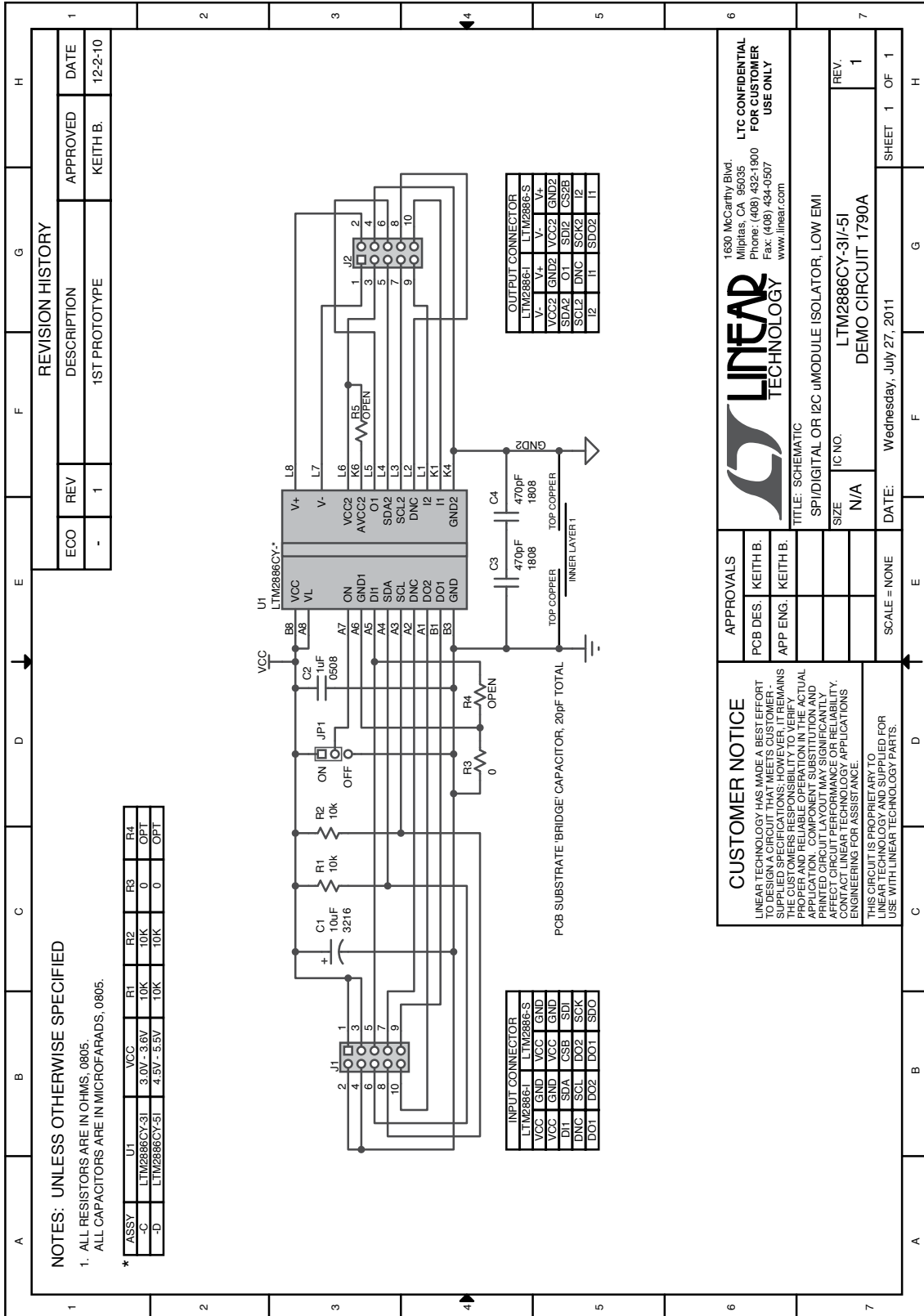

DEMO MANUAL DC1790A

DEMONSTRATION BOARD IMPORTANT NOTICE

Linear Technology Corporation (LTC) provides the enclosed product(s) under the following **AS IS** conditions:

This demonstration board (DEMO BOARD) kit being sold or provided by Linear Technology is intended for use for **ENGINEERING DEVELOPMENT OR EVALUATION PURPOSES ONLY** and is not provided by LTC for commercial use. As such, the DEMO BOARD herein may not be complete in terms of required design-, marketing-, and/or manufacturing-related protective considerations, including but not limited to product safety measures typically found in finished commercial goods. As a prototype, this product does not fall within the scope of the European Union directive on electromagnetic compatibility and therefore may or may not meet the technical requirements of the directive, or other regulations.

If this evaluation kit does not meet the specifications recited in the DEMO BOARD manual the kit may be returned within 30 days from the date of delivery for a full refund. **THE FOREGOING WARRANTY IS THE EXCLUSIVE WARRANTY MADE BY THE SELLER TO BUYER AND IS IN LIEU OF ALL OTHER WARRANTIES, EXPRESSED, IMPLIED, OR STATUTORY, INCLUDING ANY WARRANTY OF MERCHANTABILITY OR FITNESS FOR ANY PARTICULAR PURPOSE. EXCEPT TO THE EXTENT OF THIS INDEMNITY, NEITHER PARTY SHALL BE LIABLE TO THE OTHER FOR ANY INDIRECT, SPECIAL, INCIDENTAL, OR CONSEQUENTIAL DAMAGES.**

The user assumes all responsibility and liability for proper and safe handling of the goods. Further, the user releases LTC from all claims arising from the handling or use of the goods. Due to the open construction of the product, it is the user's responsibility to take any and all appropriate precautions with regard to electrostatic discharge. Also be aware that the products herein may not be regulatory compliant or agency certified (FCC, UL, CE, etc.).

No License is granted under any patent right or other intellectual property whatsoever. **LTC assumes no liability for applications assistance, customer product design, software performance, or infringement of patents or any other intellectual property rights of any kind.**

LTC currently services a variety of customers for products around the world, and therefore this transaction **is not exclusive**.

Please read the DEMO BOARD manual prior to handling the product. Persons handling this product must have electronics training and observe good laboratory practice standards. **Common sense is encouraged.**

This notice contains important safety information about temperatures and voltages. For further safety concerns, please contact a LTC application engineer.

Mailing Address:

Linear Technology
1630 McCarthy Blvd.
Milpitas, CA 95035

Copyright © 2004, Linear Technology Corporation



Компания «ЭлектроПласт» предлагает заключение долгосрочных отношений при поставках импортных электронных компонентов на взаимовыгодных условиях!

Наши преимущества:

- Оперативные поставки широкого спектра электронных компонентов отечественного и импортного производства напрямую от производителей и с крупнейших мировых складов;
- Поставка более 17-ти миллионов наименований электронных компонентов;
- Поставка сложных, дефицитных, либо снятых с производства позиций;
- Оперативные сроки поставки под заказ (от 5 рабочих дней);
- Экспресс доставка в любую точку России;
- Техническая поддержка проекта, помощь в подборе аналогов, поставка прототипов;
- Система менеджмента качества сертифицирована по Международному стандарту ISO 9001;
- Лицензия ФСБ на осуществление работ с использованием сведений, составляющих государственную тайну;
- Поставка специализированных компонентов (Xilinx, Altera, Analog Devices, Intersil, Interpoint, Microsemi, Aeroflex, Peregrine, Syfer, Eurofarad, Texas Instrument, Miteq, Cobham, E2V, MA-COM, Hittite, Mini-Circuits, General Dynamics и др.);

Помимо этого, одним из направлений компании «ЭлектроПласт» является направление «Источники питания». Мы предлагаем Вам помощь Конструкторского отдела:

- Подбор оптимального решения, техническое обоснование при выборе компонента;
- Подбор аналогов;
- Консультации по применению компонента;
- Поставка образцов и прототипов;
- Техническая поддержка проекта;
- Защита от снятия компонента с производства.



Как с нами связаться

Телефон: 8 (812) 309 58 32 (многоканальный)

Факс: 8 (812) 320-02-42

Электронная почта: org@eplast1.ru

Адрес: 198099, г. Санкт-Петербург, ул. Калинина, дом 2, корпус 4, литера А.