

TABLE OF CONTENTS



MINIATURE

Mini fuses in five sizes to 20 Amps.

- Slow Blow
- Medium Blow
- Fast Blow
- Super Fast Blow

Fuses 4-5

DIAZED

"Bottle" fuses in five sizes to 200 Amps.

- gL/gG - Slow Blow
- - Fast Blow
- gR - Semiconductor Protection

Fuses 6-7
Accessories 10-11

NEOZED

Compact fuses in three sizes to 100 Amps.

- gL/gG - Slow Blow
- gR - Semiconductor Protection

Fuses 8-9
Accessories 10-11

CYLINDER

Standard cylinder fuses are available in four sizes to 125 Amps, with or without blown fuse Indicator Pins.

- gL/gF - Line Protection
- aM - Motor Protection
- gR - Semiconductor Protection

Cylinder Bolt fuses are available in two diameters with multiple fixing centers.

- gR - Semiconductor Protection

Fuses - Standard 12-13
Fuses - Bolt 14
Accessories 15

NH

Knife Blade or Stud Mount designs in six sizes with current ratings of 2 to 1600 Amps.

- gL/gG - Line Protection
- aM - Motor Protection
- gR/aR - Semiconductor Protection

Fuses 16-21
Accessories 19



ITALIAN

Cylinder style fuses available in four sizes with current ratings from 2 to 100 Amps.

- gL - Line Protection

No Longer Available

Fuses 22

BRITISH

British Line Protection fuses are available with four mounting plate designs with current ratings from 2 to 63 Amps.

- gG - Line Protection
- gR - Semiconductor Protection
- aR - Semiconductor Protection

Fuses - Line 23
Fuses - Semi. 24-25

SQUARE BODY

Square body fuses for semiconductor devices to 1000 Amps.

- aR - Semiconductor Protection

Non Stocked By request only.

Fuses 26-31
Accessories 19

HIGH VOLTAGE

Fuses for distribution circuits in four sizes to 36KV.

Fuses 32-33

ACCESSORIES

- Screw Caps
- Adapter Screws and Rings
- Fuse Base Covers
- Fuse Bases
- Tools
- End Plates
- Microswitches
- Terminal Covers
- Fuse Handles

10-11, 15, 19

Siemens Cross Reference 34-35

MINIATURE

Miniature Fuses are typically used to protect electronic devices, laboratory and measurement instruments, stereos, TV's, VCR's etc. They are available in four sizes with a current range of 20mA to 20 Amps.

Miniature Fuses are manufactured according to VDE 0820 part 1, VDE 0820 part 2, IEC publication 127, CEE publication 4 and actual DIN standards.

Slow

Typical Marking: "T"

Medium

Typical Marking: "M"

Fast

Typical Marking: "F"

Super Fast

Typical Marking: "FF"



5 x 20



5 x 25

Ordering Information

Voltage 250V
DIN 41662
IEC-127-2/III

DIN 41571-2 DIN 41661
IEC-127-2/II
Cat. No.

Voltage 250V
DIN 41571-2

Cat. No.

Current	Voltage 250V DIN 41571-2 DIN 41661 IEC-127-2/II			Voltage 250V DIN 41571-2
	Slow	Medium	Fast	
20mA		0.02M5x20M		0.032M5x25M
32mA		0.032M5x20M		0.04M5x25M
40mA				0.05M5x25M
50mA	0.05M5x20T ¹	0.05M5x20M	0.05M5x20F ¹	0.063M5x25M
63mA		0.063M5x20M		0.08M5x25M
80mA	0.08M5x20T ¹	0.08M5x20M		0.1M5x25M
100mA	0.1M5x20T ¹	0.1M5x20M	0.1M5x20F ¹	0.125M5x25M
125mA	0.125M5x20T ¹	0.125M5x20M	0.125M5x20F ¹	0.16M5x25M
160mA	0.16M5x20T ¹	0.16M5x20M	0.16M5x20F ¹	0.2M5x25M
200mA	0.2M5x20T ¹	0.2M5x20M	0.2M5x20F ¹	0.25M5x25M
250mA	0.25M5x20T ¹	0.25M5x20M	0.25M5x20F ¹	0.315M5x25M
315mA	0.315M5x20T ¹	0.315M5x20M	0.315M5x20F ¹	
400mA	0.4M5x20T ¹	0.4M5x20M	0.4M5x20F ¹	0.4M5x25M
500mA	0.5M5x20T ¹	0.5M5x20M	0.5M5x20F ¹	0.5M5x25M
630mA	0.63M5x20T ¹	0.63M5x20M	0.63M5x20F ¹	0.63M5x25M
700mA	0.7M5x20T	0.7M5x20M	0.7M5x20F	
800mA	0.8M5x20T ¹	0.8M5x20M	0.8M5x20F ¹	0.8M5x25M
1.0A	1.0M5x20T ¹	1.0M5x20M	1.0M5x20F ¹	1.0M5x25M
1.25A	1.25M5x20T ¹	1.25M5x20M	1.25M5x20F ¹	1.25M5x25M
1.4A	1.4M5x20T	1.4M5x20M		
1.6A	1.6M5x20T ¹	1.6M5x20M	1.6M5x20F ¹	1.6M5x25M
2.0A	2.0M5x20T ¹	2.0M5x20M	2.0M5x20F ¹	2.0M5x25M
2.5A	2.5M5x20T ¹	2.5M5x20M	2.5M5x20F ¹	2.5M5x25M
3.15A	3.15M5x20T ¹	3.15M5x20M	3.15M5x20F ¹	3.15M5x25M
4.0A	4.0M5x20T ¹	4.0M5x20M	4.0M5x20F ¹	4.0M5x25M
5.0A	5.0M5x20T ¹	5.0M5x20M	5.0M5x20F ¹	5.0M5x25M
6.3A	6.3M5x20T ¹	6.3M5x20M	6.3M5x20F ¹	6.3M5x25M
7.0A				
8.0A	8.0M5x20T*	8.0M5x20M	8.0M5x20F*	8.0M5x25M *
10.0A	10.0M5x20T*	10.0M5x20M	10.0M5x20F*	10.0M5x25M *
12.5A	12.5M5x20T*	12.5M5x20M*	12.5M5x20F*	
16.0A	16.0M5x20T*	16.0M5x20M*	16.0M5x20F*	16.0M5x25M *
20.0A	20.0M5x20T*	20.0M5x20M*	20.0M5x20F*	

Std. Pk. 10

Std. Pk. 10

All fuses listed are low breaking capacity. For high breaking capacity fuses please contact Altech.

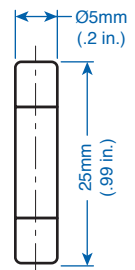
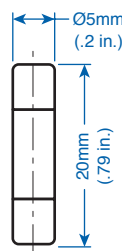

* Not standard rating.
¹ Rated Voltage 500V.
² Rated Voltage 150V.
³ Rated Voltage 60V.



**5 x 25
with Indicator**

Voltage 250V
DIN 41576-1, -2

Cat. No.	
Medium	Fast
0.08M5x25M/I	
0.1M5x25M/I	
0.125M5x25M/I	
0.16M5x25M/I	
0.2M5x25M/I	
0.25M5x25M/I	
0.315M5x25M/I	

0.4M5x25M/I	
0.5M5x25M/I	
0.63M5x25M/I	
0.8M5x25M/I	
1.0M5x25M/I	
1.25M5x25M/I	
1.6M5x25M/I	1.6M5x25F/I
2.0M5x25M/I	2.0M5x25F/I
2.5M5x25M/I	2.5M5x25F/I

3.15M5x25M/I	3.15M5x25F/I
4.0M5x25M/I	4.0M5x25F/I
5.0M5x25M/I	5.0M5x25F/I
6.3M5x25M/I	6.3M5x25F/I
8.0M5x25M/I*	8.0M5x25F/I*
10.0M5x25M/I*	10.0M5x25F/I*

Std. Pk. 10

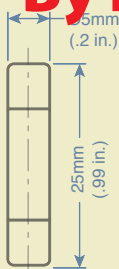

5 x 30

Voltage 500V
DIN 41571-2

Cat. No.
Medium
0.032M5x30M
0.04M5x30M
0.05M5x30M
0.063M5x30M
0.08M5x30M
0.1M5x30M
0.125M5x30M
0.16M5x30M
0.2M5x30M
0.25M5x30M
0.315M5x30M

0.4M5x30M
0.5M5x30M
0.63M5x30M
0.8M5x30M
1.0M5x30M
1.25M5x30M
1.6M5x30M
2.0M5x30M
2.5M5x30M

3.15M5x30M
4.0M5x30M
5.0M5x30M
6.3M5x30M
8.0M5x30M*
10.0M5x30M*
16.0M5x30M*

Std. Pk. 10

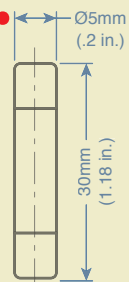

6.3 x 32

Voltage 250V

Cat. No.	
Slow	Fast
0.032M6.3x32T ⁴	
0.04M6.3x32T ⁴	
0.05M6.3x32T ⁴	0.05M6.3x32F
0.063M6.3x32T ⁴	0.063M6.3x32F
0.08M6.3x32T ⁴	0.08M6.3x32F
0.1M6.3x32T ⁴	0.1M6.3x32F
0.125M6.3x32T ⁴	0.125M6.3x32F
0.16M6.3x32T ⁴	0.16M6.3x32F
0.2M6.3x32T ⁴	0.2M6.3x32F
0.25M6.3x32T ⁴	0.25M6.3x32F
0.315M6.3x32T ⁴	0.315M6.3x32F

0.4M6.3x32T ⁴	0.4M6.3x32F
0.5M6.3x32T ⁴	0.5M6.3x32F
0.63M6.3x32T ⁴	0.63M6.3x32F
0.7M6.3x32T	0.7M6.3x32F
0.8M6.3x32T ⁴	0.8M6.3x32F
1.0M6.3x32T ⁴	1.0M6.3x32F ⁴
1.25M6.3x32T ⁴	1.25M6.3x32F ⁴
1.6M6.3x32T ⁴	1.6M6.3x32F ⁴
2.0M6.3x32T ⁴	2.0M6.3x32F ⁴
2.5M6.3x32T ⁴	2.5M6.3x32F ^{2,4}

3.15M6.3x32T ⁴	3.15M6.3x32F ^{2,4}
4.0M6.3x32T ⁴	4.0M6.3x32F ^{2,4}
5.0M6.3x32T ⁴	5.0M6.3x32F ^{3,4}
6.3M6.3x32T ⁴	6.3M6.3x32F ^{3,4}
7.0M6.3x32T	7.0M6.3x32F ³
8.0M6.3x32T	8.0M6.3x32F ³
10.0M6.3x32T	10.0M6.3x32F ³
12.5M6.3x32T	12.5M6.3x32F ³
16.0M6.3x32T	16.0M6.3x32F ³
20.0M6.3x32T	20.0M6.3x32F ³

Std. Pk. 10

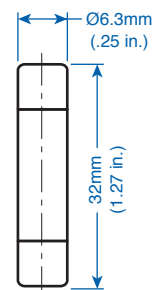

**Non Stocked
By request only.**

DIAZED (BOTTLE)

Diazed Fuses, commonly called "Bottle" Fuses, are available in five sizes, ND to 35 Amps, DII to 35 Amps, DIII to 100 Amps, DIV to 100 Amps and DV to 200 Amps. Fuse accessories are sized to match. Each size fuse body has a different diameter to fit only into the appropriate Screw Cap and Fuse Base. (See illustration pg 10.)

Also, the fuse tips have different diameters, depending on their current rating. The diameter of the tip matches the diameter of the hole in the Adapter Screw to insure that no fuse with a higher rating than intended for the circuit can be installed. This prevents damage to the circuit or equipment the fuse protects. Additionally, fuses and Adapter Screws are color coded to avoid mismatching; for example: 10 Amp Diazed fuses have red pop-out indicators on their head, matching the red ring of the 10 Amp Adapter Screw.

When a Diazed fuse has blown, the color coded indicator on the head of the fuse will pop out, giving visible indication through a glass window in the Screw Cap.

The Fuse is held in place by the Screw Cap, which is screwed into the Fuse Base. Diazed Fuse Bases are available in one and three pole designs. Fuse Bases can be panel mounted or snapped onto a standard 35mm DIN rail.

Operating Classes

gL/gG - Slow Blow

Protect cable, equipment, and conductors from damage due to overloads and short circuits.

Typical Markings: "T", Trage, gL/gG, Vollschutz,



- Fast Blow

Fast Blow fuses are typically used to protect equipment.

Typical Markings: "F", Flink, (the absence of the snail symbol)

gR - Semiconductor Protection

Typically used for protecting semiconductors like diodes, SCRs, etc. Current limiting.

Typical Markings: Ultra Rapid™, Ultra Quick™, Silized™, Recticur™, gR,



Mostly red, orange, or blue imprint.

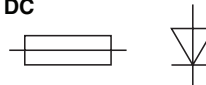

ND-E 16

Ordering Information

Slow Blow - Operating Class gL/gG (VDE 0636 / IEC 269) Cable, Equipment, and Line Protection, up to 500V AC (660V and 750V available)

Current/Voltage	Cat. No.	Color Code	Std. Pk.
2/500V AC	2D16SB	Pink	25
4/500V AC	4D16SB	Brown	25
6/500V AC	6D16SB	Green	25
10/500V AC	10D16SB	Red	25
16/500V AC	16D16SB	Gray	25
20/500V AC	20D16SB	Blue	25
25/500V AC	25D16SB	Yellow	25
30/500V AC	30D16SB *	Silver	25
35/500V AC	35D16SB *	Black	25

Fast Blow (CEE-16) - old standard for Equipment Protection, up to 500V AC (750V available)

2/500V AC	2D16FB	Pink	25
4/500V AC	4D16FB	Brown	25
6/500V AC	6D16FB	Green	25
10/500V AC	10D16FB	Red	25
16/500V AC	16D16FB	Gray	25
20/500V AC	20D16FB	Blue	25
25/500V AC	25D16FB	Yellow	25
30/500V AC	30D16FB *	Silver	25
35/500V AC	35D16FB *	Black	25

Semiconductor Protection - Operating Class gR (VDE 0636 / IEC 269) Semiconductor Protection, up to 500V AC, 440V DC

2/500V AC	2D16SC	Pink	25
4/500V AC	4D16SC	Brown	25
6/500V AC	6D16SC	Green	25
10/500V AC	10D16SC	Red	25
16/500V AC	16D16SC	Gray	25
20/500V AC	20D16SC	Blue	25
25/500V AC	25D16SC	Yellow	25
30/500V AC	30D16SC	Black	25

Screw Cap (pgs 10-11)**

D16C 1

Adapter Screw (pgs 10-11)**
(Install only with Adapter Screw Tool)

Not Available

Adapter Screw Tool (pgs 10-11)**
(for inserting or removing all Adapter Screws)

Not Available

Fuse Base, Single Pole (pgs 10-11)**
Fuse Base, Three Pole (pgs 10-11)**

D16B 1
D16B3 1

Fuse Base Cover, Single Pole (pgs 10-11)**
Fuse Base Cover, Three Pole (pgs 10-11)**

D16BC 1
D16BC3 1

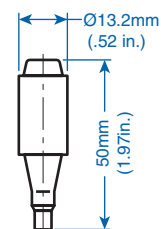

* Not standard rating.

** Refer to page indicated for additional selection and ordering information.

Dimensions to DIN 49360



DII-E 27



DIII-E 33



DIV- R 1.25

Current/ Voltage	Cat. No.	Color Code	Std. Pk.
2/500V AC	2D27SB	Pink	5
4/500V AC	4D27SB	Brown	5
6/500V AC	6D27SB	Green	5
10/500V AC	10D27SB	Red	5
16/500V AC	16D27SB	Gray	5
20/500V AC	20D27SB	Blue	5
25/500V AC	25D27SB	Yellow	5
30/500V AC	30D27SB*	Silver	5
35/500V AC	35D27SB*	Black	5

2/500V AC	2D27FB	Pink	5
4/500V AC	4D27FB	Brown	5
6/500V AC	6D27FB	Green	5
10/500V AC	10D27FB	Red	5
16/500V AC	16D27FB	Grey	5
20/500V AC	20D27FB	Blue	5
25/500V AC	25D27FB	Yellow	5
30/500V AC	30D27FB*	Silver	5
35/500V AC	35D27FB*	Black	5

2/500V AC	2D27SC	Pink	5
4/500V AC	4D27SC	Brown	5
6/500V AC	6D27SC	Green	5
10/500V AC	10D27SC	Red	5
16/500V AC	16D27SC	Grey	5
20/500V AC	20D27SC	Blue	5
25/500V AC	25D27SC	Yellow	5
30/500V AC	30D27SC	Black	5

D27C 1

Refer to pgs 10-11

DAT 1

D27B 1
D27B3 1

D27BC 1
D27BC3 1

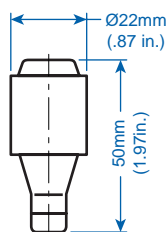

Dimensions to DIN 49515

Current/ Voltage	Cat. No.	Color Code	Std. Pk.
35/500V AC	35D33SB	Black	5
40/500V AC	40D33SB*	Black	5
50/500V AC	50D33SB	White	5
63/500V AC	63D33SB	Copper	5
80/500V AC	80D33SB*	Silver	5
100/500V AC	100D33SB*	Silver	5

35/500V AC	35D33FB	Black	5
40/500V AC	40D33FB*	Black	5
50/500V AC	50D33FB	White	5
63/500V AC	63D33FB	Copper	5
80/500V AC	80D33FB*	Silver	5
100/500V AC	100D33FB*	Silver	5

35/500V AC	35D33SC	Black	5
50/500V AC	50D33SC	White	5
63/500V AC	63D33SC	Copper	5

D33C 1

Refer to pgs 10-11

DAT 1

D33B 1
D33B3 1

D33BC 1
D33BC3 1

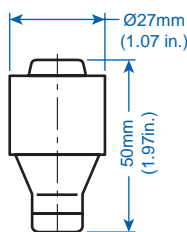

Dimensions to DIN 49515

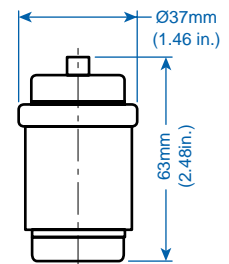

For DIV fuses, please consult Altech.



DV- R 2

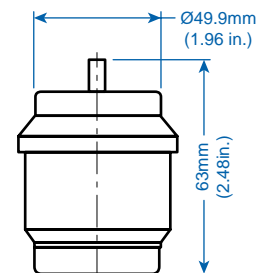

For DV fuses, please consult Altech.

NEOZED

Neozed Fuses are more compact than the Diazed Fuses. Three sizes are available, D01 to 16 Amps, D02 to 63 Amps and D03 to 100 Amps. Fuse accessories are sized to match. Each size fuse body has a different diameter to fit only into the appropriate Screw Cap and Fuse Base. (See illustration pg 10.)

Also, the fuse tips have different diameters, depending on their current rating. The diameter of the tip matches the diameter of the hole in the Adapter Ring to insure that no fuse with a higher rating than intended for the circuit can be installed. This prevents damage to the circuit or equipment the fuse protects. Additionally, fuses and Adapter Rings are color coded to avoid mismatching; for example: 10 Amp Neozed fuses have red pop-out indicators on their head, matching the red 10 Amp Adapter Ring.

When a Neozed fuse has blown, the color coded indicator on the head of the fuse will pop out, giving visible indication through a glass window in the Screw Cap.

The Fuse is held in place by the Screw Cap, which is screwed into the Fuse Base. Neozed Fuse Bases are available in one and three pole designs. Fuse Bases can be panel mounted or snapped onto a standard 35mm DIN rail.

Operating Classes

gL/gG - Slow Blow

Protect cable, conductors, and equipment from damage due to overload and short circuits.

Typical Markings: gL/gG

gR - Semiconductor Protection

Protects semiconductors like diodes, SCRs, etc. Current limiting super fast blow characteristic for short circuit protection.

Typical Markings: Ultra Rapid™, Ultra Quick™, Recticur™, gR,

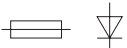

Mostly red, orange, or blue imprint.



D01

Ordering Information	Current/ Voltage	Cat. No.	Color Code	Std. Pk.
Slow Blow - Operating Class gL/gG (VDE 0636 / IEC 269) Cable, Line, and Equipment Protection up to 380V AC and 250V DC	2/380V AC	2NZ01GL	Pink	10
	4/380V AC	4NZ01GL	Brown	10
	6/380V AC	6NZ01GL	Green	10
	10/380V AC	10NZ01GL	Red	10
	16/380V AC	16NZ01GL	Gray	10
Semiconductor Protection - Operating Class gR (VDE 0636 / IEC 269) Semiconductor Protection up to 440V AC and 250V DC	2/440V AC	2NZ01SC	Pink	5
	4/440V AC	4NZ01SC	Brown	5
	6/440V AC	6NZ01SC	Green	5
	10/440V AC	10NZ01SC	Red	5
	16/440V AC	16NZ01SC	Gray	5
Screw Cap (pgs 10-11)*		NZ01C		1
Adapter Ring (pgs 10-11)* (Install only with Adapter Ring Tool)		refer to pgs 10-11		
Adapter Ring Tool (pgs 10-11)* (for inserting or removing all Adapter Rings)		NAT		1
Fuse Base, Single Pole (pgs 10-11)* Fuse Base, Three Pole (pgs 10-11)*		NZ01B		1
		NZ01B3		1
Fuse Base Cover, Single Pole (pgs 10-11)* Fuse Base Cover, Three Pole (pgs 10-11)*		NZ01BC		1
		NZ01BC3		1

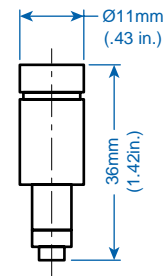
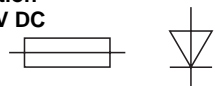

*Refer to page indicated for additional selection and ordering information.

Dimensions to DIN 49522



D02



D03

Current/ Voltage	Cat. No.	Color Code	Std. Pk.
20/380V AC	20NZ02GL	Blue	10
25/380V AC	25NZ02GL	Yellow	10
35/380V AC	35NZ02GL	Black	10
50/380V AC	50NZ02GL	White	10
63/380V AC	63NZ02GL	Copper	10

Current/ Voltage	Cat. No.	Color Code	Std. Pk.
80/380V AC	80NZ03GL	Silver	10
100/380V AC	100NZ03GL	Red	10

20/440V AC	20NZ02SC	Blue	5
25/440V AC	25NZ02SC	Yellow	5
35/440V AC	35NZ02SC	Black	5
50/440V AC	50NZ02SC	White	5
63/440V AC	63NZ02SC	Copper	5

80/440V AC	80NZ03SC	Silver	5
100/440V AC	100NZ03SC	Red	5

NZ02C 1

refer to pgs 10-11

N AT 1

NZ02B 1
NZ02B3 1

NZ02BC 1
NZ02BC3 1

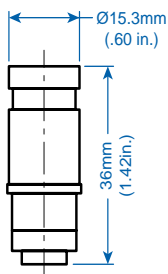

Dimensions to DIN 49522

NZ03C 1

refer to pg 10-11

N AT 1

NZ03B 1

NZ03BC 1

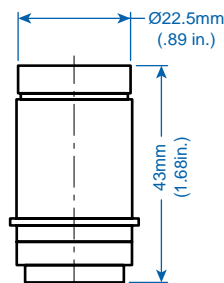

Dimensions to DIN 49522

DIAZED AND NEOZED ACCESSORIES

SCREW CAP

The Screw Cap types offered fit the various fuse and Fuse Base sizes. They hold the fuses in place and connect the head of the fuse with the load side of the Fuse Holder. The colored blown fuse indicator on the head of the fuse is clearly visible through a small window in the top of the Screw Cap. A small test hole on the side of the Cap allows for a probe to test if voltage is present on the metallic surface on the head of the fuse.

ADAPTER SCREW / RING

Adapter Screws are used with the Diazed, and Adapter Rings are used with the Neozed Fuses. Three sizes of Screws and Rings are available to fit the diameter of the different size fuse bases. Adapter Screws are porcelain rings with a center hole on one side, a threaded stud on the other and one notch on each side. The inside diameter of the center hole of the Adapter Screw matches the diameter of the tip of the Diazed fuse for which it is intended. This helps to eliminate the insertion of fuses with higher current ratings than allowed. The integral threaded stud installs into the appropriate Diazed Fuse Base. Adapter Screws and Rings are color coded to the fuses.

FUSE BASE

Fuse Bases hold fuses in place (in conjunction with the Screw Cap) and insure proper electrical connections. They snap easily onto standard 35mm DIN rail or can be panel mounted. They are available in one or three pole designs. Matching Covers are available. The line is connected to the metal tab at the bottom of the fuse base. The load is connected to the metal ring into which the Screw Cap is installed.

FUSE BASE COVER

Fuse Base Covers are available in one and three pole designs to match the Fuse Bases we offer. They help prevent shock from accidental touching of conducting metal parts on the Base.

TOOLS

The Adapter Screw / Ring Tools aid in the insertion and removal of the Adapters from the Fuse Base. The Adapter Screw Tool fits into notches on the Adapter Screw for the D27 and D33 Diazed fuses. The Adapter Ring Tool fits the Adapter Rings for the D01, D02 and D03 Neozed fuses. We strongly recommend these tools be used when inserting or removing Adapter Screws or Rings to prevent electrical shocks.

The Diazed System

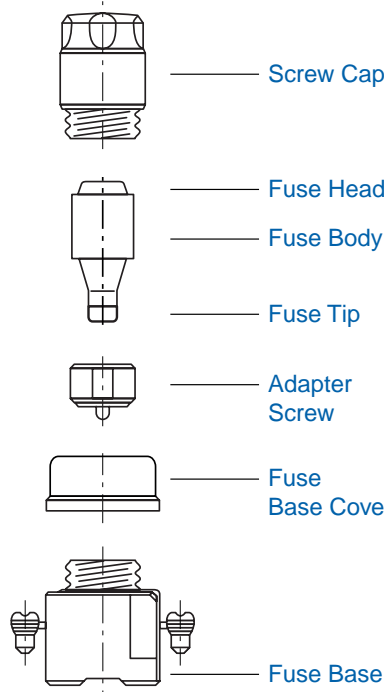

The Neozed System

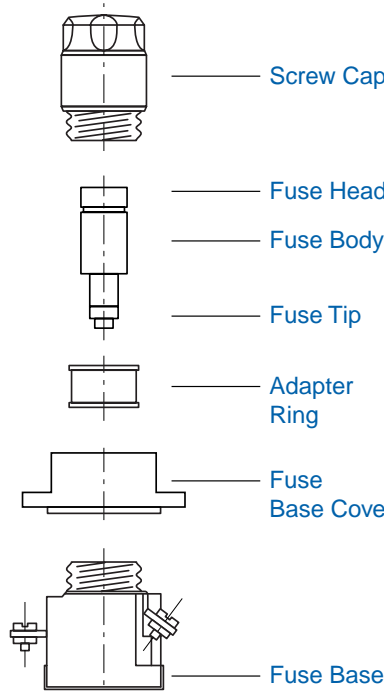

Diazed Screw Cap

Cat. No.	Height	Approx. Dim. mm (in.)		Use With Fuse(s)
		Height	Thread Dia.	
D16C	34 (1.34)	16 (.63)		ND-E 16
D27C	43 (1.69)	27 (1.06)		DII-E 27
D33C	43 (1.69)	33 (1.30)		DIII-E 33



Diazed Adapter Screw Tool

Cat. No.	Use With Fuse (s)
DAT	DII-E 27, DIII-E 33



Neozed Screw Cap

Cat. No.	Height	Approx. Dim. mm (in.)		Use With Fuse(s)
		Height	Thread Dia.	
NZ01C	31 (1.22)	14 (.55)		D01
NZ02C	31 (1.22)	18 (.71)		D02
NZ03C	37 (1.46)	30 (1.18)		D03



Neozed Adapter Ring Tool

Cat. No.	Use With Fuse(s)
NAT	D01, D02, D03



Diazed Adapter Screw

Cat. No.	Current	Color	Use With Fuse(s)
For Fuse Type DII-E 27			
D27AS02	2A	Pink	2D27SB(FB)(SC)
D27AS04	4A	Brown	4D27SB(FB)(SC)
D27AS06	6A	Green	6D27SB(FB)(SC)
D27AS10	10A	Red	10D27SB(FB)(SC)
D27AS16	16A	Gray	16D27SB(FB)(SC)
D27AS20	20A	Blue	20D27SB(FB)(SC)
D27AS25	25A	Yellow	25D27SB(FB)(SC)
Height : 14mm (.55 in.)			
For Fuse Type DIII-E 33			
D33AS35	35A	Black	35D33SB(FB)(SC)
D33AS40	40A	Black	40D33SB(FB)(SC)
D33AS50	50A	White	50D33SB(FB)(SC)
D33AS63	63A	Copper	63D33SB(FB)(SC)
Height : 14mm (.55 in.)			

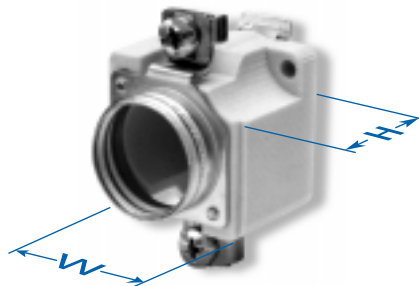

Diazed Fuse Base

No. of Poles	Cat. No.	Approx. Dim. mm (in.)		Use With Fuse(s)
		Height	Width	
1	D16B	45 (1.77)	29 (1.14)	ND-E 16
1	D27B	46 (1.81)	38 (1.50)	DII-E 27
1	D33B	48 (1.89)	49 (1.93)	DIII-E 33
3	D27B3	46 (1.81)	90 (3.54)	DII-E 27
3	D33B3	46 (1.81)	109 (4.29)	DIII-E 33

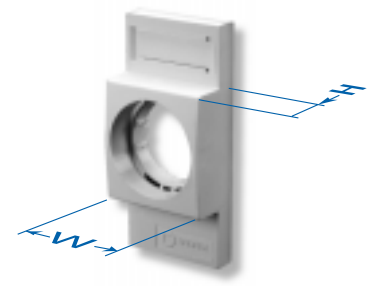

Diazed Fuse Base Cover

No. of Poles	Cat. No.	Approx. Dim. mm (in.)		Use With Fuse(s)
		Height	Width	
1	D16BC	20 (.79)	40 (1.57)	ND-E 16
1	D27BC	20 (.79)	40 (1.57)	DII-E 27
1	D33BC	20 (.79)	49 (1.93)	DIII-E 33
3	D27BC3	20 (.79)	90 (3.54)	DII-E 27
3	D33BC3	20 (.79)	111 (4.37)	DIII-E 33



Neozed Adapter Ring

Cat. No.	Current	Color	Use With Fuse(s)
For Fuse Type D01			
NZ01AR02	2A	Pink	2NZ01GL(SC)
NZ01AR04	4A	Brown	4NZ01GL(SC)
NZ01AR06	6A	Green	6NZ01GL(SC)
NZ01AR10	10A	Red	10NZ01GL(SC)
Height : 10mm (.39 in.)			
For Fuse Type D02			
NZ02AR20	20A	Blue	20NZ02GL(SC)
NZ02AR25	25A	Yellow	25NZ02GL(SC)
NZ02AR35	35A	Black	35NZ02GL(SC)
NZ02AR50	50A	White	50NZ02GL(SC)
Height : 10mm (.39 in.)			
For Fuse Type D03			
NZ03AR80	80A	Silver	80NZ03GL(SC)
Height : 10mm (.39 in.)			

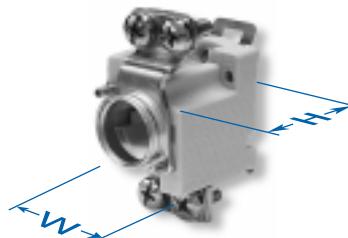

Neozed Fuse Base

No. of Poles	Cat. No.	Approx. Dim. mm (in.)		Use With Fuse(s)
		Height	Width	
1	NZ01B	42 (1.65)	27 (1.06)	D01
1	NZ02B	42 (1.65)	27 (1.06)	D02
1	NZ03B	46 (1.81)	44 (1.73)	D03
3	NZ01B3	42 (1.65)	81 (3.19)	D01
3	NZ02B3	42 (1.65)	81 (3.19)	D02

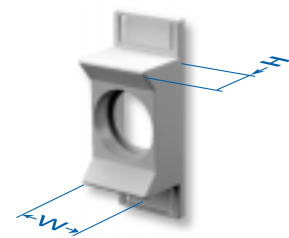

Neozed Fuse Base Cover

No. of Poles	Cat. No.	Approx. Dim. mm (in.)		Use With Fuse(s)
		Height	Width	
1	NZ01BC	23 (.91)	27 (1.06)	D01
1	NZ02BC	23 (.91)	27 (1.06)	D02
1	NZ03BC	18 (.71)	44 (1.73)	D03
3	NZ01BC3	23 (.91)	81 (3.19)	D01
3	NZ02BC3	23 (.91)	81 (3.19)	D02

CYLINDER

Cylinder Fuses are typically used in industrial applications to protect electrical devices such as motors, drives, etc.

They are available in four sizes with a current range from 1 to 100 Amps. Cylinder Fuses have metal caps at both ends, and a porcelain fuse body.

Please refer to pg 15 for ordering information for Cylinder Fuse Holders.

Operating Class

GI / gL / gG - Line Protection

Slow Blow, typically used for power distribution and resistive loads.

Typical Markings: gL, gG

Black imprint.

aM - Motor Protection

Fast acting short circuit protection, but slow acting overload protection.

Typical Marking: aM

Green imprint.

aR - Semiconductor Protection

Typically used for protecting semiconductors like diodes, SCR's etc. Current limiting, super fast blow.

Typical Markings: Ultra Rapid™,

Ultra Quick™, Protister™, gR,

Blue imprint.



8 x 32

Ordering Information	Current/ Voltage	Cat. No.	Std. Pk.
----------------------	---------------------	----------	----------

Slow Blow - Operating Class gI (IEC 269 / CEI 32) Line Protection	1/400V AC	1C8x32GI	10
	2/400V AC	2C8x32GI	10
	4/400V AC	4C8x32GI	10
	6/400V AC	6C8x32GI	10
	8/400V AC	8C8x32GI	10
	10/400V AC	10C8x32GI	10
	12/400V AC	12C8x32GI	10
	16/400V AC	16C8x32GI	10
	20/400V AC	20C8x32GI	10
	25/400V AC	25C8x32GI	10

Weight: 4 g each

Fast Blow - Operating Class aM (IEC 269 / CEI 32) Motor Protection	1/400V AC	1C8x32AM	10
	2/400V AC	2C8x32AM	10
	4/400V AC	4C8x32AM	10
	6/400V AC	6C8x32AM	10
	8/400V AC	8C8x32AM	10
	10/400V AC	10C8x32AM	10
	12/400V AC	12C8x32AM	10
	16/400V AC	16C8x32AM	10
	20/400V AC	20C8x32AM	10
	25/400V AC	25C8x32AM	10

Weight: 4 g each

Semiconductor Protection - Operating Class gR
(VDE 0636 / IEC 269)
Semiconductor Protection

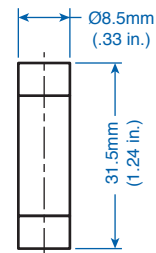
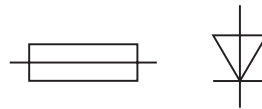

Dimensions to NFC 61200, NFC 63210,
NFC 63211 (NFC = French Standard)

* Selected fuse are also available with Striker Pin. When ordering Fuse with Striker Pin, designate suffix "IS" after the Cat. No. (Ex. 2C14x51GI/IS). Contact Altech for more information.



10 x 38

Current/ Voltage	Cat. No.	Std. Pk.
0.5/500V AC	0.5C10x38GI	10
1/500V AC	1C10x38GI	10
2/500V AC	2C10x38GI	10
4/500V AC	4C10x38GI	10
6/500V AC	6C10x38GI	10
8/500V AC	8C10x38GI	10
10/500V AC	10C10x38GI	10
12/500V AC	12C10x38GI	10
16/500V AC	16C10x38GI	10
20/400V AC	20C10x38GI	10
25/400V AC	25C10x38GI	10
32/400V AC	32C10x38GI	10

Weight: 10 g each

0.5/500V AC	0.5C10x38AM	10
1/500V AC	1C10x38AM	10
2/500V AC	2C10x38AM	10
4/500V AC	4C10x38AM	10
6/500V AC	6C10x38AM	10
8/500V AC	8C10x38AM	10
10/500V AC	10C10x38AM	10
12/500V AC	12C10x38AM	10
16/500V AC	16C10x38AM	10
20/400V AC	20C10x38AM	10
25/400V AC	25C10x38AM	10
32/400V AC	32C10x38AM	10

Weight: 10 g each

1/600V AC	DISCONTINUED 1C10x38SC	10
2/600V AC	2C10x38SC	10
4/600V AC	4C10x38SC	10
6/600V AC	6C10x38SC	10
8/600V AC	8C10x38SC	10
10/600V AC	10C10x38SC	10
12/600V AC	12C10x38SC	10
16/600V AC	16C10x38SC	10
20/600V AC	20C10x38SC	10
25/600V AC	25C10x38SC	10
30/600V AC	30C10x38SC	10
32/600V AC	32C10x38SC	10

Weight: 10 g each

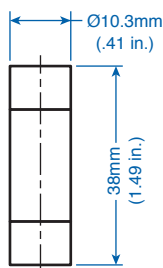

Dimensions to NFC 60200, NFC 63210, NFC 63211 (NFC = French Standard)



14 x 51

Current/ Voltage	Cat. No.	Std. Pk.
1/660V AC	DISCONTINUED 1C14x51GI	10
2/690V AC	2C14x51GI *	10
4/690V AC	4C14x51GI *	10
6/690V AC	6C14x51GI *	10
8/690V AC	8C14x51GI *	10
10/690V AC	10C14x51GI *	10
12/690V AC	12C14x51GI *	10
16/690V AC	16C14x51GI *	10
20/690V AC	20C14x51GI *	10
25/690V AC	25C14x51GI *	10
32/500V AC	32C14x51GI	10
40/500V AC	40C14x51GI	10
50/500V AC	50C14x51GI	10

Weight: 20 g each

1/660V AC	DISCONTINUED 1C14x51AM	10
2/690V AC	2C14x51AM *	10
4/690V AC	4C14x51AM *	10
6/690V AC	6C14x51AM *	10
8/690V AC	8C14x51AM *	10
10/690V AC	10C14x51AM *	10
12/690V AC	12C14x51AM *	10
16/690V AC	16C14x51AM *	10
20/690V AC	20C14x51AM *	10
25/690V AC	25C14x51AM *	10
32/500V AC	32C14x51AM	10
40/500V AC	40C14x51AM	10
50/500V AC	50C14x51AM	10

Weight: 20 g each

1/660V AC	DISCONTINUED 1C14x51SC	10
2/660V AC	2C14x51SC	10
4/660V AC	4C14x51SC	10
6/660V AC	6C14x51SC	10
8/660V AC	8C14x51SC	10
10/690V AC	10C14x51SC *	10
12/690V AC	12C14x51SC *	10
16/690V AC	16C14x51SC *	10
20/690V AC	20C14x51SC *	10
25/690V AC	25C14x51SC *	10
32/690V AC	32C14x51SC *	10
40/690V AC	40C14x51SC *	10
50/690V AC	50C14x51SC *	10

Weight: 20 g each

*Also available with striker pin.

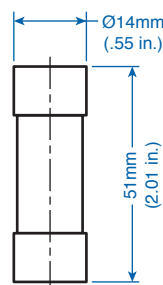

Dimensions to NFC 60200, NFC 63210, NFC 63211 (NFC = French Standard)



22 x 58

Current/ Voltage	Cat. No.	Std. Pk.
6/660V AC	DISCONTINUED 6C22x58GI *	10
8/660V AC	8C22x58GI *	10
10/660V AC	10C22x58GI *	10
12/660V AC	12C22x58GI *	10
16/690V AC	16C22x58GI *	10
20/690V AC	20C22x58GI *	10
25/690V AC	25C22x58GI *	10
32/690V AC	32C22x58GI *	10
40/690V AC	40C22x58GI *	10
50/500V AC	50C22x58GI *	10
63/500V AC	63C22x58GI *	10
80/500V AC	80C22x58GI *	10
100/500V AC	100C22x58GI *	10

Weight: 51 g each

6/660V AC	DISCONTINUED 6C22x58AM *	10
8/660V AC	8C22x58AM *	10
10/660V AC	10C22x58AM *	10
12/660V AC	12C22x58AM *	10
16/690V AC	16C22x58AM *	10
20/690V AC	20C22x58AM *	10
25/690V AC	25C22x58AM *	10
32/690V AC	32C22x58AM *	10
40/690V AC	40C22x58AM *	10
50/690V AC	50C22x58AM *	10
63/500V AC	63C22x58AM *	10
80/500V AC	80C22x58AM *	10
100/500V AC	100C22x58AM *	10

Weight: 51 g each

4/660V AC	DISCONTINUED 4C22x58SC	10
6/660V AC	6C22x58SC	10
8/660V AC	8C22x58SC	10
10/660V AC	10C22x58SC	10
12/660V AC	12C22x58SC	10
16/660V AC	16C22x58SC	10
20/690V AC	20C22x58SC *	10
25/690V AC	25C22x58SC *	10
32/690V AC	32C22x58SC *	10
40/690V AC	40C22x58SC *	10
50/690V AC	50C22x58SC *	10
63/690V AC	63C22x58SC *	10
80/690V AC	80C22x58SC *	10
100/500V AC	100C22x58SC *	10

Weight: 51 g each

*Also available with striker pin.

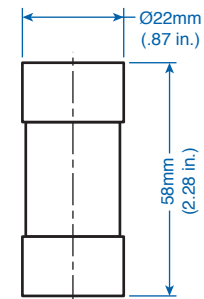

Dimensions to NFC 60200, NFC 63210, NFC 63211 (NFC = French Standard)

Fuse Holders, 10 x 38 mm and CC Type

The main characteristics of fuse disconnectors are:

- UL recognized (10x38mm)
- UL listed (CC Type)
- Compliance with IEC 60947-1, IEC 60947-3
- Plastic parts are made of material resistant to high temperatures
- All contact surfaces are silver plated
- Mounting on standard DIN 35 mm rail (DIN EN60715).
- Available up to 4 pole
- For all sizes a version with electronic indicator is available. There are two technical types of indicator:

L (LED) (10x38mm only) with built in LED diode which blinks after the fuse-link operates. The internal circuit resistance is 2M, thus the total dissipation is minimal. The indicator is capable of operating in conditions of open circuit with minimum capacitance between connection cables. Operating voltage range spans from 50V to 690V AC and DC.

I (NEON) (10x38mm only) with neon lamp, which is constantly lit after the fuse-link operates. The internal circuit resistance is 570k, thus it is necessary that the circuit be closed in order for the indicator to function. The operational voltage range is 100 V to 750 V AC.

* Fuses are sold separately Altech, see pages 100-101.

** 1000V UL PV rating pending.

Cylindrical 10 x 38



CC Type

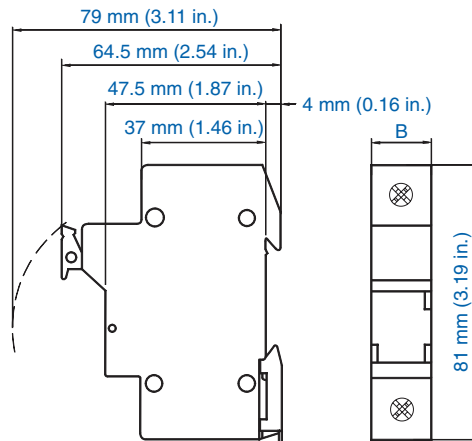

Dimension for B:

1 Pole	17.5mm
1 Pole + Neutral	35mm
2 Pole	35mm
3 Pole	52.5mm
3 Pole + Neutral	70mm

	1 POLE	2 POLE	3 POLE
--	--------	--------	--------



Terminal Width (B)	17.5 mm	35 mm	52.5 mm
Height x Length	81 x 64.5 mm	81 x 64.5 mm	81 x 64.5 mm
Stripping Length	11 mm	11 mm	11 mm
Insulation Material	Aculon®	Aculon®	Aculon®
Type of Connection	2 screw clamps	2 screw clamps	2 screw clamps
Wire Range	1.5-25sq.mm / 24-4 AWG	1.5-25sq.mm / 24-4 AWG	1.5-25sq.mm / 24-4 AWG
Rating	690 V / 32A	690 V / 32A	690 V / 32A
Rating	600 V AC/DC / 30A	600 V AC/DC / 30A	600 V AC/DC / 30A
Torque	2-2.5 Nm / 31 lb-in	2-2.5 Nm / 31 lb-in	2-2.5 Nm / 31 lb-in

Cylindrical 10x38

Indicator:	Cat. No.	Std. Pk.	Cat. No.	Std. Pk.	Cat. No.	Std. Pk.
None	CB1038-1	1	CB1038-2	1	CB1038-3	1
LED	CB1038-1/L	1	CB1038-2/L	1	CB1038-3/L	1
Neon	CB1038-1/I	1	CB1038-2/I	1	CB1038-3/I	1

Type of Fuse Used	Ø10 x 38 mm	Ø10 x 38 mm	Ø10 x 38 mm
Approvals**			

CC Type Holder

Cat. No.	Std. Pk.	Cat. No.	Std. Pk.	Cat. No.	Std. Pk.
CB10CC-1	1	CB10CC-2	1	CB10CC-3	1

Type of Fuse Used	CC Type	CC Type	CC Type
Approvals			

DIN Rail	35mm	35mm	35mm	35mm
for ordering information refer to pages 90-91				

End Stop	CA702	50	CA702	50	CA702	50
for ordering information refer to page 92	CA802	50	CA802	50	CA802	50

Cylinder Fuse Holders, 8 x 31 mm, 14 x 51 mm and 22 x 58 mm

Fuse Bases secure the fuses in place and insure proper electrical connections. Fuse Bases are available in one, two, three and four pole designs. Types 8x31 and 10x38 are easily DIN rail mounted; Types 14x51 and 22x58 can be DIN rail mounted or mounted to any flat surface. Cylinder Fuse Bases are available with optional blown fuse indication.

The main characteristics of fuse disconnectors are:











- UL recognized (8x31 and 14x51 mm only)
- Compliance with IEC 60947-1, IEC 60947-3
- Plastic parts are made of material resistant to high temperatures
- All contact surfaces are silver plated
- Mounting on standard DIN 35 mm rail (DIN EN60715).
- Available up to 4 pole
- For all sizes a version with electronic indicator is available.

The 8x31 fuse holders with indicator are built with a NEON lamp, which is constantly lit after the fuselink operates. The internal circuit resistance is 570k, thus it is necessary that the circuit be closed in order for the indicator to function. The operational voltage range is 100 V to 750 V AC.

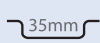
The 14x51 and 22x58 fuse holders with indicator have a built in LED which blinks after the fuse-link operates. The internal circuit resistance is 2M, thus the total dissipation is minimal. The indicator is capable of operating in conditions of open circuit with minimum capacitance between connection cables. Operating voltage range spans from 50V to 690V AC and DC.

	8 x 31	14 x 51	22 x 58
Terminal Width			
1 pole:	17.5 mm (0.69 in.)	27 mm (1.07 in.)	27 mm (1.07 in.)
1 pole + indicator:	17.5 mm (0.69 in.)	27 mm (1.07 in.)	27 mm (1.07 in.)
1 pole + N:	35 mm (1.38 in.)	54 mm (2.15 in.)	71 mm (2.80 in.)
2 pole:	35 mm (1.38 in.)	54 mm (2.15 in.)	71 mm (2.80 in.)
2 pole + indicator:	35 mm (1.38 in.)	54 mm (2.15 in.)	71 mm (2.80 in.)
3 pole:	52.5 mm (2.07 in.)	81 mm (3.20 in.)	107 mm (4.20 in.)
3 pole + indicator:	52.5 mm (2.07 in.)	81 mm (3.20 in.)	107 mm (4.20 in.)
3 pole + N:	70 mm (2.76 in.)	108 mm (4.25 in.)	142.5 mm (5.60 in.)
Height x Length	81 x 64.5 mm (3.20 x 2.40 in)	94 x 70 mm (3.70 x 2.76 in)	120.5 x 70 mm (4.73 x 2.76 in)
Insulation Material	Aculon®	Aculon®	Aculon®
Type of Connection	2 screw clamps	2 screw clamps	2 screw clamps
Wire Range			
Minimum	1 sq mm (18 AWG)	1 sq mm (18 AWG)	1.5 sq mm (16 AWG)
Max. Stranded	16 sq mm (6 AWG)	25 sq mm (4 AWG)	35 sq mm (2 AWG)
Max. Solid	25 sq mm (4 AWG)	35 sq mm (2 AWG)	50 sq mm (1 AWG)
Rating	600V AC/DC / 30A	600V AC/DC / 50A	N/A
Rating	400V AC/DC / 20A	400V AC/DC / 50A 500V AC/DC / 32A 690V AC/DC / 25A	400V AC/DC / 125A 500V AC/DC / 100A 690V AC/DC / 80A
Torque	2-2.5 Nm / 31 lb-in	2.5 Nm / 22 lb-in	3 Nm / 26 lb-in

Type	Cat. No.	Std. Pk.	Cat. No.	Std. Pk.	Cat. No.	Std. Pk.
1 pole:	CB831-1	12	CB1451-1	12	CB2258-1	3
1 pole + indicator:	CB831-1/I	12	CB1451-1/I	12	CB2258-1/I	3
1 pole + N:	CB831-1N	6	CB1451-1N	6	CB2258-1N	2
2 pole:	CB831-2	6	CB1451-2	6	CB2258-2	2
2 pole + indicator:	CB831-2/I	6	CB1451-2/I	6	CB2258-2/I	2
3 pole:	CB831-3	4	CB1451-3	4	CB2258-3	1
3 pole + indicator:	CB831-3/I	4	CB1451-3/I	4	CB2258-3/I	1
3 pole + N:	CB831-3N	3	CB1451-3N	3	CB2258-3N	1

Type of Fuse Used	8x32 mm		14x51 mm		22x58 mm	
Approvals**						
DIN Rail						
End Stop	CA702 CA802	50 50	CA702 CA802	50 50	CA702 CA802	50 50

* Fuses are sold separately.

NH KNIFE BLADE

NH fuses are typically used for power distribution applications and to protect large electrical devices such as motors, drives, etc. They are available in seven sizes with a current range of 2 to 1600 Amps.

NH fuses have knife blades at both ends, which mount into Fuse Bases. Fuse Bases are available in one or three pole designs and can be panel or DIN rail mounted.

Please refer to pg 19 for NH Fuse Accessories.

Operating Classes

gL/gG - Line Protection

Slow, typically used for distribution circuits or resistive loads.

Typical Marking: *gL/gG*



aM - Motor Protection

Fast acting short circuit protection, but slow acting overload protection.

Typical Marking: *aM*
Green imprint.

aR - Semiconductor Protection

Partial range, short circuit protection for devices such as diodes, SCRs, etc.

Typical Markings: *Ultra Rapid™, Sitor™, Silcu™, Protistor™, Reticur™, Ultra Quick™, aR,*

gR - Semiconductor Protection

Full range overload and short circuit protection for devices such as diodes, SCRs, etc.

Typical Markings: *Ultra Rapid™, Sitor™, Silcu™, Protistor™, Reticur™, Ultra Quick™, gR,*
Mostly red, orange or blue imprint.



NH00 (NHC00)³

Ordering Information

Operating Class gL / gG
(VDE 0636 / IEC 269)
Line Protection up to 500V AC
(660V available)

Current/ Voltage

Cat. No. Dim. Std. Pk.

2/500V AC	2NH00GL	A	3
4/500V AC	4NH00GL	A	3
6/500V AC	6NH00GL	A	3
10/500V AC	10NH00GL	A	3
16/500V AC	16NH00GL	A	3
20/500V AC	20NH00GL	A	3
25/500V AC	25NH00GL	A	3
32/500V AC	32NH00GL	A	3
35/500V AC	35NH00GL	A	3
40/500V AC	40NH00GL	A	3
50/500V AC	50NH00GL	A	3
63/500V AC	63NH00GL	A	3
80/500V AC	80NH00GL	A	3
100/500V AC	100NH00GL	A	3
125/500V AC	125NH00GL	A	3
160/500V AC	160NH00GL	A	3

NH00 Fuses Operating Class gL / gG are available in 660V, and with insulated tags.

Operating Class aM
(VDE 0636 / IEC 269)
Motor Protection up to 660V AC

2/660V AC	2NH00AM-6	A	3
4/660V AC	4NH00AM-6	A	3
6/660V AC	6NH00AM-6	A	3
10/660V AC	10NH00AM-6	A	3
16/660V AC	16NH00AM-6	A	3
20/660V AC	20NH00AM-6	A	3
25/660V AC	25NH00AM-6	A	3
32/660V AC	32NH00AM-6	A	3
35/660V AC	35NH00AM-6	A	3
40/660V AC	40NH00AM-6	A	3
50/660V AC	50NH00AM-6	A	3
63/660V AC	63NH00AM-6	A	3
80/660V AC	80NH00AM-6	A	3
100/660V AC	100NH00AM-6	A	3
125/500V AC	125NH00AM	A	3
160/500V AC	160NH00AM	A	3

Super Fast Blow Operating Class aR / gR
(VDE 0636 / IEC 269)
Semiconductor Protection up to 660V AC
(1000V available)

16/660V AC	16NH00GR-6¹	A	3
20/660V AC	20NH00GR-6¹	A	3
25/660V AC	25NH00GR-6¹	A	3
32/660V AC	32NH00GR-6¹	A	3
35/660V AC	35NH00GR-6¹	A	3
40/660V AC	40NH00GR-6¹	A	3
50/660V AC	50NH00GR-6¹	A	3
63/660V AC	63NH00GR-6¹	A	3
80/660V AC	80NH00GR-6¹	A	3
100/660V AC	100NH00GR-6¹	A	3
125/660V AC	125NH00GR-6¹	A	3
160/660V AC	160NH00AR-6	A	3

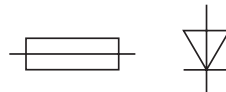

¹ Also available in Operating Class aR.

² Also available in 1000V. Designate suffix "-1" (ex. 32NH0GR-1).

³ Size NHC00 will be supplied in place of NH00 at manufacturer discretion.

⁴ Knife blade is available with screw holes, please designate a "B" after the size, (ex. 250NH3BAR-6).

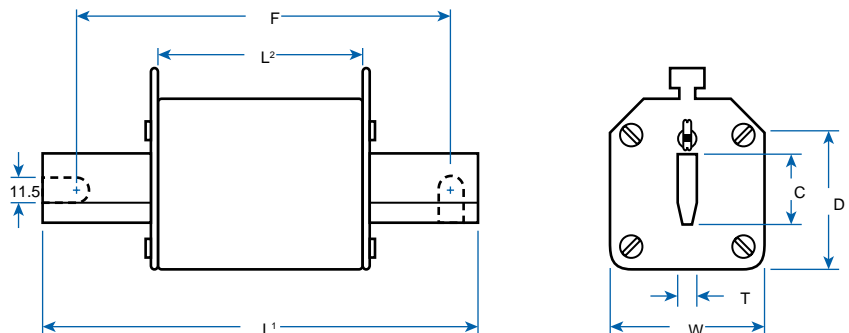



NHO



NH1



NH2

Current/ Voltage	Cat. No.	Dim.	Std. Pk.	Current/ Voltage	Cat. No.	Dim.	Std. Pk.	Current/ Voltage	Cat. No.	Dim.	Std. Pk.
10/500V AC	10NH0GL	B	3	16/500V AC	16NH1GL	C	3	35/500V AC	35NH2GL	E	3
16/500V AC	16NH0GL	B	3	20/500V AC	20NH1GL	C	3	40/500V AC	40NH2GL	E	3
20/500V AC	20NH0GL	B	3	25/500V AC	25NH1GL	C	3	50/500V AC	50NH2GL	E	3
25/500V AC	25NH0GL	B	3	32/500V AC	32NH1GL	C	3	63/500V AC	63NH2GL	E	3
32/500V AC	32NH0GL	B	3	35/500V AC	35NH1GL	C	3	80/500V AC	80NH2GL	E	3
35/500V AC	35NH0GL	B	3	40/500V AC	40NH1GL	C	3	100/500V AC	100NH2GL	E	3
40/500V AC	40NH0GL	B	3	50/500V AC	50NH1GL	C	3	125/500V AC	125NH2GL	E	3
50/500V AC	50NH0GL	B	3	63/500V AC	63NH1GL	C	3	160/500V AC	160NH2GL	E	3
63/500V AC	63NH0GL	B	3	80/500V AC	80NH1GL	C	3	200/500V AC	200NH2GL	E	3
80/500V AC	80NH0GL	B	3	100/500V AC	100NH1GL	C	3	224/500V AC	224NH2GL	E	3
100/500V AC	100NH0GL	B	3	125/500V AC	125NH1GL	C	3	250/500V AC	250NH2GL	E	3
125/500V AC	125NH0GL	B	3	160/500V AC	160NH1GL	C	3	300/500V AC	300NH2GL	E	3
160/500V AC	160NH0GL	B	3	200/500V AC	200NH1GL	D	3	315/500V AC	315NH2GL	F	3
200/500V AC	200NH0GL	B	3	224/500V AC	224NH1GL	D	3	355/500V AC	355NH2GL	F	3
				250/500V AC	250NH1GL	D	3	400/500V AC	400NH2GL	F	3
								425/500V AC	425NH2GL	F	3
10/500V AC	10NH0AM	B	3	16/500V AC	16NH1AM	C	3	35/500V AC	35NH2AM	E	3
16/500V AC	16NH0AM	B	3	20/500V AC	20NH1AM	C	3	40/500V AC	40NH2AM	E	3
20/500V AC	20NH0AM	B	3	25/500V AC	25NH1AM	C	3	50/500V AC	50NH2AM	E	3
25/500V AC	25NH0AM	B	3	32/500V AC	32NH1AM	C	3	63/500V AC	63NH2AM	E	3
32/500V AC	32NH0AM	B	3	35/500V AC	35NH1AM	C	3	80/500V AC	80NH2AM	E	3
35/500V AC	35NH0AM	B	3	40/500V AC	40NH1AM	C	3	100/500V AC	100NH2AM	E	3
40/500V AC	40NH0AM	B	3	50/500V AC	50NH1AM	C	3	125/500V AC	125NH2AM	E	3
50/500V AC	50NH0AM	B	3	63/500V AC	63NH1AM	C	3	160/500V AC	160NH2AM	E	3
63/500V AC	63NH0AM	B	3	80/500V AC	80NH1AM	C	3	200/500V AC	200NH2AM	E	3
80/500V AC	80NH0AM	B	3	100/500V AC	100NH1AM	C	3	224/500V AC	224NH2AM	E	3
100/500V AC	100NH0AM	B	3	125/500V AC	125NH1AM	C	3	250/500V AC	250NH2AM	E	3
125/500V AC	125NH0AM	B	3	160/500V AC	160NH1AM	C	3	315/500V AC	315NH2AM	F	3
160/500V AC	160NH0AM	B	3	200/500V AC	200NH1AM	D	3	355/500V AC	355NH2AM	F	3
				224/500V AC	224NH1AM	D	3	400/500V AC	400NH2AM	F	3
				250/500V AC	250NH1AM	D	3				
16/660V AC	16NH0GR-6	B	3	16/660V AC	16NH1GR-6	C	3	32/660V AC	32NH2GR-6	E	3
20/660V AC	20NH0GR-6	B	3	20/660V AC	20NH1GR-6	C	3	40/660V AC	40NH2GR-6	E	3
25/660V AC	25NH0GR-6	B	3	25/660V AC ²	25NH1GR-6 ⁴	C	3	50/660V AC	50NH2GR-6	E	3
32/660V AC ²	32NH0GR-6	B	3	32/660V AC ²	32NH1GR-6 ⁴	C	3	63/660V AC	63NH2GR-6	E	3
40/660V AC ²	40NH0GR-6	B	3	35/660V AC ²	35NH1GR-6 ⁴	C	3	80/660V AC	80NH2GR-6 ⁴	E	3
50/660V AC ²	50NH0GR-6	B	3	40/660V AC ²	40NH1GR-6 ⁴	C	3	100/660V AC	100NH2GR-6 ⁴	E	3
63/660V AC ²	63NH0GR-6	B	3	50/660V AC ²	50NH1GR-6 ⁴	C	3	125/660V AC	125NH2GR-6 ⁴	E	3
80/660V AC ²	80NH0GR-6	B	3	63/660V AC ²	63NH1GR-6 ⁴	C	3	160/660V AC	160NH2AR-6 ⁴	E	3
100/660V AC ²	100NH0GR-6	B	3	80/660V AC ²	80NH1GR-6 ⁴	C	3	200/660V AC	200NH2AR-6 ⁴	E	3
125/660V AC ²	125NH0GR-6	B	3	100/660V AC ²	100NH1GR-6 ⁴	C	3	250/660V AC	250NH2AR-6 ⁴	E	3
160/660V AC ²	160NH0AR-6	B	3	125/660V AC ²	125NH1GR-6 ⁴	C	3	280/660V AC	280NH2AR-6 ⁴	E	3
				160/660V AC ²	160NH1AR-6 ⁴	C	3	315/660V AC	315NH2AR-6 ⁴	F	3
				200/660V AC ²	200NH1AR-6 ⁴	D	3	355/660V AC	355NH2AR-6 ⁴	E	3
				224/660V AC ²	224NH1AR-6 ⁴	D	3	400/660V AC	400NH2AR-6 ⁴	F	3
				250/660V AC ²	250NH1AR-6 ⁴	D	3				
				315/500V AC	315NH1AR	D	3				

Approximate Dimensions for NH Fuses mm (in.)*

NH Size/Dim.	Overall Length (L ₁)	Body Length (L ₂)	Body Depth (D)	Body Width (W)	Blade Width (T)	Blade Thickness (C)	Fixing Center (F)
C00	79(3.11)	53 (2.09)	40 (1.57)	21 (0.83)	6 (0.24)	15 (0.59)	110 (4.33)
00/A	79(3.11)	52 (2.05)	42.5 (1.67)	28 (1.10)	6 (0.24)	15 (0.59)	110 (4.33)
0/B	125 (4.92)	65 (2.56)	42 (1.65)	29 (1.14)	6 (0.24)	15 (0.59)	110 (4.33)
1/C	135 (5.31)	65 (2.56)	42 (1.65)	29 (1.14)	6 (0.24)	15 (0.59)	110 (4.33)
1/D	135 (5.31)	65 (2.56)	48 (1.89)	40 (1.57)	6 (0.24)	20 (0.79)	110 (4.33)
2/E	150 (5.91)	65 (2.56)	48 (1.89)	40 (1.57)	6 (0.24)	20 (0.79)	110 (4.33)
2/F	150 (5.91)	65 (2.56)	60 (2.36)	53 (2.10)	6 (0.24)	26 (1.02)	110 (4.33)

*Dimensions to DIN 43620 refer to diagram on pg 16

NH KNIFE BLADE



NH 3



NH 4

Ordering Information	Current/ Voltage	Cat. No.	Dim.	Std. Pk.	Current/ Voltage	Cat. No.	Dim.	Std. Pk.	
Operating Class gG / gL (VDE 0636 / IEC 269) Line Protection up to 500V AC (660V Available)	224/500V AC	224NH3GL	F	3	400/500V AC ⁵	400NH4GL	H	1	
	250/500V AC	250NH3GL	F	3	500/500V AC ⁵	500NH4GL	H	1	
	300/500V AC	300NH3GL	F	3	630/500V AC ⁵	630NH4GL	H	1	
	315/500V AC	315NH3GL	F	3	710/500V AC	710NH4GL	H	1	
	355/500V AC	355NH3GL	F	3	800/500V AC ⁵	800NH4GL	H	1	
	400/500V AC	400NH3GL	F	3	850/500V AC	850NH4GL	H	1	
	500/500V AC	500NH3GL	G	3	900/500V AC	900NH4GL	H	1	
	630/500V AC	630NH3GL	G	3	1000/500V AC	1000NH4GL	H	1	
					1250/500V AC	1250NH4GL	H	1	
					1600/500V AC	1600NH4GL	I	1	
Operating Class aM (VDE 0636 / IEC 269) Motor Protection up to 660V AC	224/500V AC	224NH3AM	F	3	400/500V AC	400NH4AM	H	1	
	250/500V AC	250NH3AM	F	3	500/500V AC	500NH4AM	H	1	
	300/500V AC	300NH3AM	F	3	630/500V AC ⁵	630NH4AM	H	1	
	315/500V AC	315NH3AM	F	3	800/500V AC ⁵	800NH4AM	H	1	
	355/500V AC	355NH3AM	F	3	1000/500V AC ⁵	1000NH4AM	H	1	
	400/500V AC	400NH3AM	F	3	1250/500V AC	1250NH4AM	H	1	
	500/500V AC	500NH3AM	G	3					
	630/500V AC	630NH3AM	G	3					
Operating Class aR (VDE 0636 / IEC 269) Semiconductor Protection up to 660V AC (1000V Available)	250/660V AC	250NH3AR-6⁴	F	3					
	280/660V AC	280NH3AR-6⁴	F	3					
	300/660V AC	300NH3AR-6⁴	F	3					
	315/660V AC	315NH3AR-6⁴	F	3					
	355/660V AC	355NH3AR-6⁴	F	3					
	400/660V AC	400NH3AR-6⁴	F	3					
	500/660V AC	500NH3AR-6⁴	G	3					
	560/660V AC	560NH3AR-6⁴	G	3					
	630/660V AC	630NH3AR-6⁴	G	3					
For Accessories, please refer to pg 19					For Accessories, please refer to pg 19				

⁴ Knife blade is available with screw holes, please designate a "B" after the size, (ex. 250NH3BAR-6).

⁵ Also available in 660VAC, please consult Altech.

Approximate Dimensions for NH Fuses mm (in.)*

NH Size/Dim.	Overall Length (L ¹)	Body Length (L ²)	Body Depth (D)	Body Width (W)	Blade Thickness (T)	Blade Depth (C)	Fixing Center (F)
3/F	150 (5.91)	65 (2.56)	60 (2.36)	53 (2.10)	6 (0.24)	26 (1.02)	110 (4.33)
3/G	150 (5.91)	65 (2.56)	70 (2.75)	62 (2.44)	6 (0.24)	32 (1.26)	110 (4.33)
4/H	200 (7.87)	65 (2.56)	110 (4.33)	102 (4.01)	8 (0.31)	50 (1.97)	150 (5.91)
4/I	200 (7.87)	87 (3.42)	110 (4.33)	102 (4.01)	8 (0.31)	50 (1.97)	150 (5.91)

*Dimensions to DIN 43620 refer to diagram on pg 16

NH FUSE ACCESSORIES

FUSE BASE

Fuse Bases hold fuses in place and insure proper electrical connections. Available in one or three pole designs. Three-pole Fuse Bases are supplied with two Separator Plates which should be installed between poles. We recommend the use of End Plates and Terminal Covers for increased safety.

END PLATE

End Plates increase safety and provide separation between devices. Install by inserting End Plate into mounting entry slot on right or left side of Fuse Base. We recommend installing one End Plate on each side of the Fuse Base.

TERMINAL COVER

Covers increase safety by covering the conducting metal hardware of the Fuse Base and the Fuse. We suggest Terminal Covers be used in conjunction with End Plates. To install slide Terminal Cover over terminal slot and snap in place.

MICROSWITCH

Microswitches can be field mounted on NH fuses for remote blown fuse indication. (Sketch below)

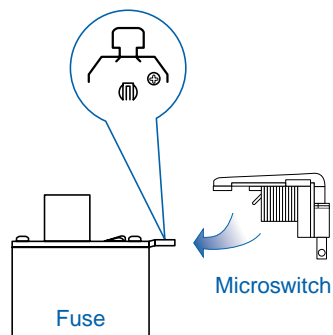

FUSE HANDLE

We strongly suggest using the Fuse Handle when inserting or removing fuses from the Fuse Base to prevent electrical shocks. For increased safety, use Fuse Handle with integral safety glove. Both Fuse Handles are for use with NH-Knife Blade Fuses, NH00 - NH4.



Fuse Base

No. of Poles	Cat. No.	Length mm (in.)	Use With Fuse(s)
1	NHB00-1	122 (4.80)	NH00
3	NHB00-3	139 (5.47)	NH00
1	NHB0-1	170 (6.69)	NH0
1	NHB1-1	202 (7.95)	NH1
3	NHB1-3	214 (8.42)	NH1
1	NHB2-1	227 (8.94)	NH2
3	NHB2-3	260 (10.24)	NH2
1	NHB3-1	242 (9.53)	NH3
1	NHB4-1	310 (12.20)	NH4
1	NHB4A-1	338 (13.31)	NH4A
1	NHSMB	146 (5.75)	NH00SM



Fuse End Plate

Cat. No.	Approx. Dim. mm (in.)	Use With Fuse Base(s)
	Width Length	
NHEP00	62 (2.44) 121 (4.76)	NHB00-1-3
NHEP0	62 (2.44) 180 (7.09)	NHB0-1-3
NHEP1	62 (2.44) 214 (8.42)	NHB1-1-3
NHEP2	90 (3.54) 260 (10.24)	NHB2-1-3
NHEP3	101 (3.98) 242 (9.53)	NHB3-1-3



Microswitch

Cat. No.	Current/Voltage	Use With Fuse(s)
NHMS	5/250V AC (SPDT)	NH Knife Blade or NH Stud Mount (All Sizes)



Terminal Cover

Cat. No.	Use With Fuse Base(s)
NHTC00	NHB00-1-3



Fuse Handle

Cat. No.	Description
NHHA	Fuse Handle
NHSG	Fuse Handle with Safety Glove

For maximum protection use Fuse Handle with integral safety glove, not shown.

NH STUD MOUNT Semiconductor

Semiconductor Fuses have extremely fast acting trip characteristics and provide short circuit and overload protection for diodes, SCR's etc. Current limiting, super fast blow.

Semiconductor Fuses offered comply with IEC, DIN and VDE standards and are available in two trip characteristics, defined below.

For Accessories, please refer to pg 19 for NH Fuses.

Operating Classes (VDE 0636 / IEC 269)

gR - Full Range Protection

Overload and short circuit protection.

Typical Markings: Ultra Rapid™, Silcu™, Recticur™, Protistor™, Ultra Quick™, gR

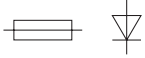

Mostly red, orange, or blue imprint.

aR - Partial Range Protection

Short circuit protection only. Faster acting than full range fuses.

Typical Markings: Ultra Rapid™, Silcu™, Recticur™, Protistor™, Ultra Quick™, aR

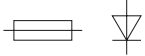

Mostly red, orange, or blue imprint.



NH00C/SM
Stud Mount

Class gR

Current/ Voltage	Cat. No.	Std. Pk.
16/660V AC	16SM00CGR	3
20/660V AC	20SM00CGR	3
25/660V AC	25SM00CGR	3
32/660V AC	32SM00CGR	3
40/660V AC ¹	40SM00CGR	3
50/660V AC ¹	50SM00CGR	3
63/660V AC ¹	63SM00CGR	3
80/660V AC ¹	80SM00CGR	3
100/660V AC ¹	100SM00CGR	3
125/660V AC ¹	125SM00CGR	3

Class aR

160/660V AC ¹	160SM00CAR	3
200/660V AC ¹	200SM00CAR	3
250/660V AC ¹	250SM00CAR	3
315/500V AC ¹	315SM00CAR	3



NH00C/SM-L
Stud Mount with
Microswitch Holder

Class gR

Current/ Voltage	Cat. No.	Std. Pk.
16/660V AC	16SM00CGR-L	3
20/660V AC	20SM00CGR-L	3
25/660V AC	25SM00CGR-L	3
32/660V AC	32SM00CGR-L	3
35/660V AC	35SM00CGR-L	3
40/660V AC	40SM00CGR-L	3
50/660V AC	50SM00CGR-L	3
63/660V AC	63SM00CGR-L	3
80/660V AC	80SM00CGR-L	3
100/660V AC	100SM00CGR-L	3
125/660V AC	125SM00CGR-L	3

Class aR

160/660V AC	160SM00CAR-L	3
180/660V AC	180SM00CAR-L	3

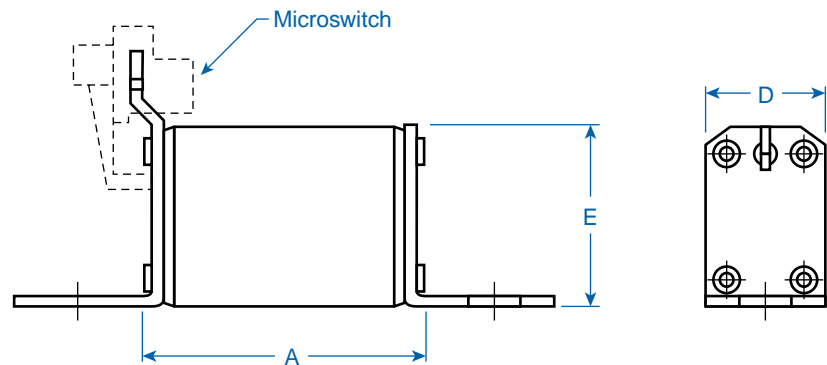

¹ UL recognized version available upon request. UL rated at 700VAC.

² Also available in operating class aR.



NH00/SM
Stud Mount

Class gR

Current/ Voltage	Cat. No.	Std. Pk.
16/660V AC ²	16SM00GR	3
20/660V AC ²	20SM00GR	3
25/660V AC ²	25SM00GR	3
32/660V AC ²	32SM00GR	3
35/660V AC ²	35SM00GR	3
40/660V AC ²	40SM00GR	3
50/660V AC ²	50SM00GR	3
63/660V AC ²	63SM00GR	3
80/660V AC ²	80SM00GR	3
100/660V AC ²	100SM00GR	3
125/660V AC ²	125SM00GR	3

Class aR

160/660V AC ¹	160SM00AR	3
200/660V AC ¹	200SM00AR	3
250/660V AC ¹	250SM00AR	3
315/660V AC ¹	315SM00AR	3
350/660V AC ¹	350SM00AR	3
400/660V AC	400SM00AR	3



NH00/SM-L
Stud Mount with
Microswitch Holder

Class gR

Current/ Voltage	Cat. No.	Std. Pk.
6/660V AC ²	6SM00GR-L	3
10/660V AC ²	10SM00GR-L	3
16/660V AC ²	16SM00GR-L	3
20/660V AC ²	20SM00GR-L	3
25/660V AC ²	25SM00GR-L	3
32/660V AC ²	32SM00GR-L	3
35/660V AC ²	35SM00GR-L	3
40/660V AC ²	40SM00GR-L	3
50/660V AC ²	50SM00GR-L	3
63/660V AC ²	63SM00GR-L	3
80/660V AC ²	80SM00GR-L	3
100/660V AC ²	100SM00GR-L	3
125/660V AC ²	125SM00GR-L	3

Class aR

160/660V AC	160SM00AR-L	3
200/660V AC	200SM00AR-L	3
250/660V AC	250SM00AR-L	3
315/660V AC	315SM00AR-L	3
350/660V AC	350SM00AR-L	3
400/660V AC	400SM00AR-L	3



NH0/SM-L
Stud Mount with
Microswitch Holder

Class gR

Current/ Voltage	Cat. No.	Std. Pk.
6/660V AC	6SM0GR-L	3
10/660V AC	10SM0GR-L	3
16/660V AC	16SM0GR-L	3
20/660V AC	20SM0GR-L	3
25/660V AC	25SM0GR-L	3
32/660V AC	32SM0GR-L	3
35/660V AC	35SM0GR-L	3
40/660V AC	40SM0GR-L	3
50/660V AC	50SM0GR-L	3
63/660V AC	63SM0GR-L	3
80/660V AC	80SM0GR-L	3
100/660V AC	100SM0GR-L	3
125/660V AC	125SM0GR-L	3

Class aR

160/660V AC	160SM0AR-L	3
-------------	------------	---

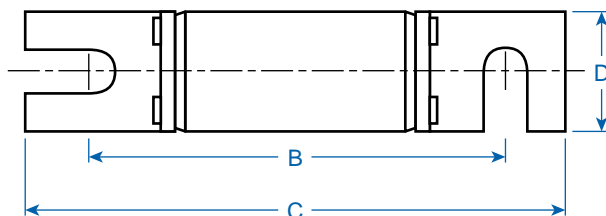

**Approximate Dimensions
Stud Mount mm (in.)***

Dim.	NHC00	NH00	NH0
A	55 (2.17)	55 (2.17)	69 (2.72)
B	80 (3.15)	80 (3.15)	97 (3.82)
C	100 (3.94)	100 (3.94)	120 (4.72)
D	20 (0.79)	28 (1.10)	28 (1.10)
E	39 (1.54)	50 (1.97)	50 (1.97)

*Dimensions to DIN 43653

ITALIAN

Cylinder Fuses to Italian standards are typically used for machinery imported from Italy.

They are available in four sizes with a current range from 2 to 100 Amps. These fuses have metal caps at both ends, a ceramic body, and a blown fuse indicator.

Operating Class (IEC269 / CEI 32)

gl - Line Protection

Slow Blow, typically used for power distribution or resistive loads.

Typical Marking: *gl*



8.5 x 32 (C)

Current/ Voltage	Cat No.	Std. Pk.
2/380V AC	2C/T	10
4/380V AC	4C/T	10
6/380V AC	6C/T	10
10/380V AC	10C/T	10
16/380V AC	16C/T	10
20/380V AC	20C/T	10
25/380V AC	25C/T	10



9 x 36 (C1)

Current/ Voltage	Cat No.	Std. Pk.
2/380V AC	2C1/T1	10
4/380V AC	4C1/T1	10
6/380V AC	6C1/T1	10
10/380V AC	10C1/T1	10
16/380V AC	16C1/T1	10
20/380V AC	20C1/T1	10
25/380V AC	25C1/T1	10
30/380V AC	30C1/T1	10
35/380V AC	35C1/T1	10
40/380V AC	40C1/T1	10

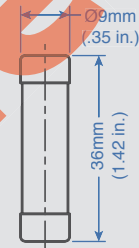
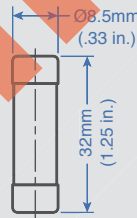

13 x 50 (C2)

Current/ Voltage	Cat No.	Std. Pk.
20/380V AC	20C2/T2	10
25/380V AC	25C2/T2	10
30/380V AC	30C2/T2	10
35/380V AC	35C2/T2	10
40/380V AC	40C2/T2	10
50/380V AC	50C2/T2	10



24 x 50 (C3)

Current/ Voltage	Cat No.	Std. Pk.
50/380V AC	50C3/T3	10
63/380V AC	63C3/T3	10
80/380V AC	80C3/T3	10
100/380V AC	100C3/T3	10

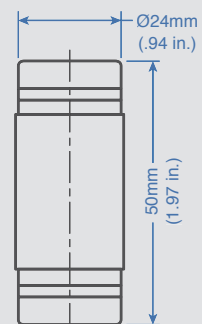
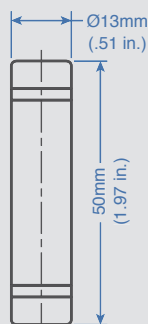

BRITISH

British fuses are typically used for industrial and general applications to protect cable and motor circuits. They are available with four different mounting plates. The most common sizes are shown here. Please consult Altech if you require sizes not listed.

Operating Class
(IEC 269 / BS 88)

gG - Line Protection

Typically used for cable and motor circuits.

Typical Marking: gG / Q1



NS



NIT (A1)

Current/ Voltage	Cat. No.	Std. Pk.
2/415V AC	2NSGG	10
4/415V AC	4NSGG	10
6/415V AC	6NSGG	10
10/415V AC	10NSGG	10
16/415V AC	16NSGG	10
20/415V AC	20NSGG	10
25/415V AC	25NSGG	10
32/415V AC	32NSGG	10

Current/ Voltage	Cat. No.	Std. Pk.
2/550V AC	2NITGG	10
4/550V AC	4NITGG	10
6/550V AC	6NITGG	10
10/550V AC	10NITGG	10
16/550V AC	16NITGG	10
20/550V AC	20NITGG	10
25/550V AC	25NITGG	10
32/550V AC	32NITGG	10

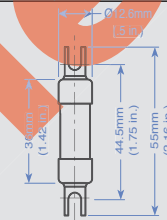
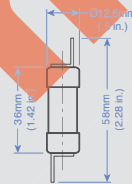

TIA (A2)



TIS (A3)

Current/ Voltage	Cat. No.	Std. Pk.
2/550V AC	2TIAGG	10
4/550V AC	4TIAGG	10
6/550V AC	6TIAGG	10
10/550V AC	10TIAGG	10
16/550V AC	16TIAGG	10
20/550V AC	20TIAGG	10
25/550V AC	25TIAGG	10
32/550V AC	32TIAGG	10

Current/ Voltage	Cat. No.	Std. Pk.
35/550V AC	35TISGG	10
40/550V AC	40TISGG	10
50/550V AC	50TISGG	10
63/550V AC	63TISGG	10

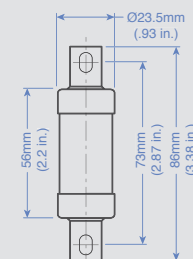
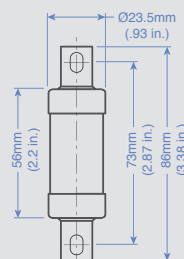

BRITISH SEMICONDUCTOR

British Semiconductor fuses are typically used for industrial applications to protect semiconductors like diodes, SCR's, etc.

They are available in single and double body units with multiple diameters and fixing centers. The fuses have mounting tabs for bolt mounting.

Operating Class (IEC269/BS88:4)

aR - Semiconductor Protection

Partial Range, short circuit protection.



8.4mm (0.33in) (D)

Ordering Information	Current/ Voltage	Cat. No.	Std. Pk.
38mm (1.50 in.) Fixing Center (F) Fuse	5/240V AC	5B8x38SC-2	10
	10/240V AC	10B8x38SC-2	10
	15/240V AC	15B8x38SC-2	10
	20/240V AC	20B8x38SC-2	10
41mm (1.61 in.) Fixing Center (F) Fuse			
57-62mm (2.24-2.44 in.) Fixing Center (F) Fuse			
62mm (2.44 in.) Fixing Center (F) Fuse			
63.5mm (2.50 in.) Fixing Center (F) Fuse	5/660V AC	5B8x63SC-6	10
	10/660V AC	10B8x63SC-6	10
	15/660V AC	15B8x63SC-6	10
	20/660V AC	20B8x63SC-6	10
80-86mm (3.15-3.39 in.) Fixing Center (F) Fuse			

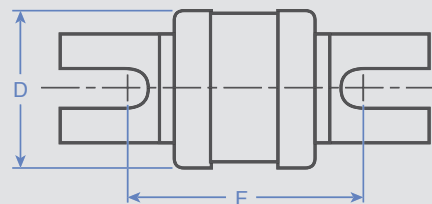

No Longer Available



17.5mm (0.69in) (D)



35mm (1.38in) (D)



Double 35mm (1.38in) (D)

Current/ Voltage	Cat. No.	Std. Pk.	Current/ Voltage	Cat. No.	Std. Pk.	Current/ Voltage	Cat. No.	Std. Pk.
25/240VAC	25B17x41SC-2	10	150/240VAC	150B35x57SC-2	3	300/240VAC	300BD35x57SC-2	1
50/240VAC	50B17x41SC-2	10	200/240VAC	200B35x57SC-2	3	350/240VAC	350BD35x57SC-2	1
75/240VAC	75B17x41SC-2	10	300/240VAC	300B35x57SC-2	3	400/240VAC	400BD35x57SC-2	1
100/240VAC	100B17x41SC-2	10				450/240VAC	450BD35x57SC-2	1
125/240VAC	125B17x41SC-2	10				500/240VAC	500BD35x57SC-2	1
150/240VAC	150B17x41SC-2	10				600/240VAC	600BD35x57SC-2	1
25/660VAC	25B17x62SC-6	10						
50/660VAC	50B17x62SC-6	10						
75/660VAC	75B17x62SC-6	10						
			100/660VAC	100B35x80SC-6	3	300/660VAC	300B35x80SC-6	1
			150/660VAC	150B35x80SC-6	3	400/660VAC	400B35x80SC-6	1
			200/660VAC	200B35x80SC-6	3	450/660VAC	450B35x80SC-6	1
			250/660VAC	250B35x80SC-6	3	500/660VAC	600B35x80SC-6	1

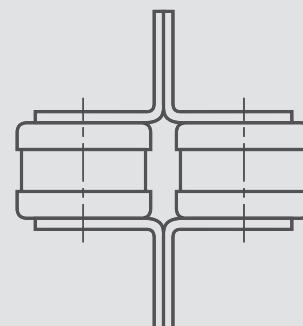
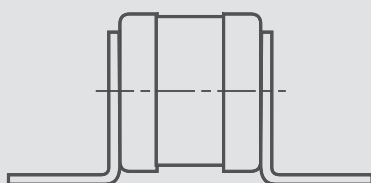

SQUARE BODY Semiconductor

Square Body Fuses provide short circuit protection for semiconductor devices such as diodes, SCR's, etc.

Square Body Fuses are available in three sizes with threaded holes in the metal end caps. They can be supplied with a Flap Indicator or a Center Indicator for visual trip indication.

The Center Indicator has a provision for mounting an Adapter and Microswitch for remote indication.



Semiconductor Fuses offered comply with IEC, DIN and VDE.

Operating Class

aR - Partial Range Protection

(VDE 0636 / IEC 269)

Short circuit protection only.

Typical Markings: *Ultra Rapid™*,
Silcu™, *Protistor™*, aR  

Mostly red, orange, or blue imprint.

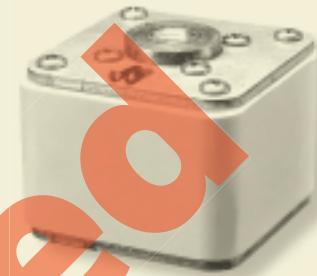

Square Body With Threaded Holes Size 1 Class aR

Square Body With Threaded Holes Size 2 Class aR

Ordering Information	Current/ Voltage	Cat. No.	Dim.	Std. Pk.	Current/ Voltage	Cat. No.	Dim.	Std. Pk.	
Fuse with Flap Indicator up to 660V AC	80/660V AC	80SB1F0-6	A	1	400/660V AC	400SB2F0-6	C	1	
	100/660V AC	100SB1F0-6	A	1	450/660V AC	450SB2F0-6	C	1	
	125/660V AC	125SB1F0-6	A	1	500/660V AC	500SB2F0-6	C	1	
	160/660V AC	160SB1F0-6	A	1	550/660V AC	550SB2F0-6	C	1	
	200/660V AC	200SB1F0-6	A	1	630/660V AC	630SB2F0-6	C	1	
	250/660V AC	250SB1F0-6	A	1	700/660V AC	700SB2F0-6	C	1	
	315/660V AC	315SB1F0-6	A	1					
	350/660V AC	350SB1F0-6	A	1					
	400/660V AC	400SB1F0-6	A	1					
	450/660V AC	450SB1F0-6	A	1					
	500/660V AC	500SB1F0-6	A	1					
	Fuse with Center Indicator¹ up to 660V AC	80/660V AC	80SB1C0-6	A	1	400/660V AC	400SB2C0-6	C	1
		100/660V AC	100SB1C0-6	A	1	450/660V AC	450SB2C0-6	C	1
125/660V AC		125SB1C0-6	A	1	500/660V AC	500SB2C0-6	C	1	
160/660V AC		160SB1C0-6	A	1	550/660V AC	550SB2C0-6	C	1	
200/660V AC		200SB1C0-6	A	1	630/660V AC	630SB2C0-6	C	1	
250/660V AC		250SB1C0-6	A	1	700/660V AC	700SB2C0-6	C	1	
315/660V AC		315SB1C0-6	A	1					
350/660V AC		350SB1C0-6	A	1					
400/660V AC		400SB1C0-6	A	1					
450/660V AC		450SB1C0-6	A	1					
500/660V AC	500SB1C0-6	A	1						
Fuse with Flap Indicator up to 1000V AC	200/1000V AC	200SB1F0-1	B	1	315/1000V AC	315SB2F0-1	D	1	
	250/1000V AC	250SB1F0-1	B	1	350/1000V AC	350SB2F0-1	D	1	
	315/1000V AC	315SB1F0-1	B	1	400/1000V AC	400SB2F0-1	D	1	
	350/1000V AC	350SB1F0-1	B	1	450/1000V AC	450SB2F0-1	D	1	
	400/1000V AC	400SB1F0-1	B	1	500/1000V AC	500SB2F0-1	D	1	
	450/1000V AC	450SB1F0-1	B	1	556/1000V AC	556SB2F0-1	D	1	
	500/1000V AC	500SB1F0-1	B	1	630/1000V AC	630SB2F0-1	D	1	
Fuse with Center Indicator¹ up to 1000V AC	200/1000V AC	200SB1C0-1	B	1	315/1000V AC	315SB2C0-1	D	1	
	250/1000V AC	250SB1C0-1	B	1	350/1000V AC	350SB2C0-1	D	1	
	315/1000V AC	315SB1C0-1	B	1	400/1000V AC	400SB2C0-1	D	1	
	350/1000V AC	350SB1C0-1	B	1	450/1000V AC	450SB2C0-1	D	1	
	400/1000V AC	400SB1C0-1	B	1	500/1000V AC	500SB2C0-1	D	1	
	450/1000V AC	450SB1C0-1	B	1	556/1000V AC	556SB2C0-1	D	1	
	500/1000V AC	500SB1C0-1	B	1	630/1000V AC	630SB2C0-1	D	1	
Adapter for Microswitch¹ See installation on pg 27.	660V	SBA6		1	660V	SBA6		1	
	1000V	SBA1		1	1000V	SBA1		1	
Microswitch² (SPDT) See installation on pg 27.	6/250V AC	SBMS		1	6/250V AC	SBMS		1	

¹ We recommend the Adapter be used on Fuses with Center Indicators whether or not a Microswitch is used.

² An Adapter is required to mount the Microswitch. (Adapters will not fit on fuses with Flap Indicators)



Square Body With Threaded Holes Size 3 Class aR

Current/ Voltage	Cat. No.	Dim.	Std. Pk.
500/660V AC	500SB3F0-6	E	1
550/660V AC	550SB3F0-6	E	1
630/660V AC	630SB3F0-6	E	1
700/660V AC	700SB3F0-6	E	1
800/660V AC	800SB3F0-6	E	1
900/660V AC	900SB3F0-6	E	1
1000/660V AC	1000SB3F0-6	E	1

500/660V AC	500SB3C0-6	E	1
550/660V AC	550SB3C0-6	E	1
630/660V AC	630SB3C0-6	E	1
700/660V AC	700SB3C0-6	E	1
800/660V AC	800SB3C0-6	E	1
900/660V AC	900SB3C0-6	E	1
1000/660V AC	1000SB3C0-6	E	1

500/1000V AC	500SB3F0-1	F	1
550/1000V AC	550SB3F0-1	F	1
630/1000V AC	630SB3F0-1	F	1
700/1000V AC	700SB3F0-1	F	1
800/1000V AC	800SB3F0-1	F	1
1000/1000V AC	1000SB3F0-1	F	1

500/1000V AC	500SB3C0-1	F	1
550/1000V AC	550SB3C0-1	F	1
630/1000V AC	630SB3C0-1	F	1
700/1000V AC	700SB3C0-1	F	1
800/1000V AC	800SB3C0-1	F	1
1000/1000V AC	1000SB3C0-1	F	1

660V	SBA6	1
1000V	SBA1	1

6/250V AC	SBMS	1
-----------	------	---

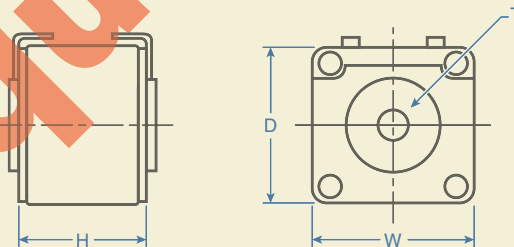
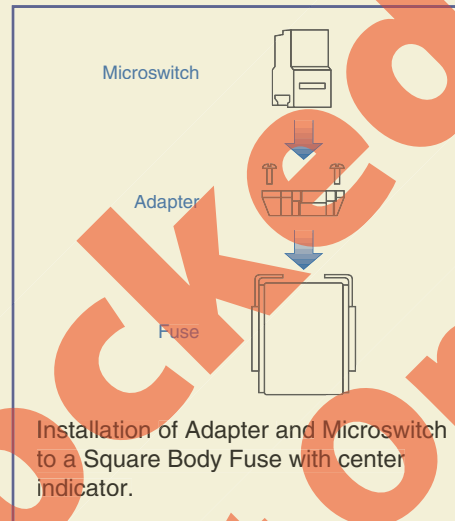

Approximate Dimensions for Square Body Fuses mm (in.)*

Fuse Size/Dim.	Body Width (W)	Body Height (H)	Body Depth (D)	Thread Dia. (T)
1/A	51 (2.00)	52 (2.05)	51 (2.00)	M8 (.314)
1/B	51 (2.00)	75 (2.95)	51 (2.00)	M8 (.314)
2/C	60 (2.36)	52 (2.05)	60 (2.36)	M10 (.393)
2/D	60 (2.36)	75 (2.95)	60 (2.36)	M10 (.393)
3/E	75 (2.95)	52 (2.05)	75 (2.95)	M12 (.472)
3/F	75 (2.95)	75 (2.95)	75 (2.95)	M12 (.472)

*Dimensions to DIN 43653

SQUARE BODY Semiconductor

Square Body Fuses provide short circuit protection for semiconductor devices such as diodes, SCR's, etc.

Square Body Fuses are available in three sizes with knife blades in two fixing lengths, 80mm (3.15 in.) and 110mm (4.33 in.). They can be supplied with a Flap Indicator or a Center Indicator for visual trip indication. The Center Indicator has a provision for mounting an Adapter and Microswitch for remote indication.

Semiconductor Fuses offered comply with IEC, DIN and VDE.

Operating Class

aR - Partial Range Protection

(VDE 0636 / IEC 269)

Short circuit protection only.

Typical Markings: Ultra Rapid™, Silcu™, Protistor™, aR,  

Mostly red, orange, or blue imprint.



Square Body
With Knife Blade 80mm (3.15 in.)
Size 1
Class aR



Square Body
With Knife Blade 80mm (3.15 in.)
Size 2
Class aR

Ordering Information	Current/ Voltage	Cat. No.	Std. Pk.	Current/ Voltage	Cat. No.	Std. Pk.	
Fuse with Flap Indicator up to 660V AC	80/660V AC	80SB1F8-6	1	400/660V AC	400SB2F8-6	1	
	100/660V AC	100SB1F8-6	1	450/660V AC	450SB2F8-6	1	
	125/660V AC	125SB1F8-6	1	500/660V AC	500SB2F8-6	1	
	160/660V AC	160SB1F8-6	1	550/660V AC	550SB2F8-6	1	
	200/660V AC	200SB1F8-6	1	630/660V AC	630SB2F8-6	1	
	250/660V AC	250SB1F8-6	1	700/660V AC	700SB2F8-6	1	
	315/660V AC	315SB1F8-6	1				
	350/660V AC	350SB1F8-6	1				
	400/660V AC	400SB1F8-6	1				
	450/660V AC	450SB1F8-6	1				
	500/660V AC	500SB1F8-6	1				
	Fuse with Center Indicator¹ up to 660V AC	80/660V AC	80SB1C8-6	1	400/660V AC	400SB2C8-6	1
		100/660V AC	100SB1C8-6	1	450/660V AC	450SB2C8-6	1
125/660V AC		125SB1C8-6	1	500/660V AC	500SB2C8-6	1	
160/660V AC		160SB1C8-6	1	550/660V AC	550SB2C8-6	1	
200/660V AC		200SB1C8-6	1	630/660V AC	630SB2C8-6	1	
250/660V AC		250SB1C8-6	1	700/660V AC	700SB2C8-6	1	
315/660V AC		315SB1C8-6	1				
350/660V AC		350SB1C8-6	1				
400/660V AC		400SB1C8-6	1				
450/660V AC		450SB1C8-6	1				
500/660V AC		500SB1C8-6	1				
Adapter¹ (See installation on page 29)		660V	SBA6	1	660V	SBA6	1
Microswitch² (SPDT) See installation on pg 29		6/250V AC	SBMS	1	6/250V AC	SBMS	1

¹ We recommend the Adapter be used on Fuses with Center Indicators whether or not a Microswitch is used.

² An Adapter is required to mount the Microswitch. (Adapters will not fit on fuses with Flap Indicators)



Square Body
With Knife Blade 80mm (3.15 in.)
Size 3
Class aR

Current/ Voltage	Cat. No.	Std. Pk.
500/660V AC	500SB3F8-6	1
550/660V AC	550SB3F8-6	1
630/660V AC	630SB3F8-6	1
700/660V AC	700SB3F8-6	1
800/660V AC	800SB3F8-6	1
900/660V AC	900SB3F8-6	1
1000/660V AC	1000SB3F8-6	1

500/660V AC	500SB3C8-6	1
550/660V AC	550SB3C8-6	1
630/660V AC	630SB3C8-6	1
700/660V AC	700SB3C8-6	1
800/660V AC	800SB3C8-6	1
900/660V AC	900SB3C8-6	1
1000/660V AC	1000SB3C8-6	1

660V	SBA6	1
6/250V AC	SBMS	1

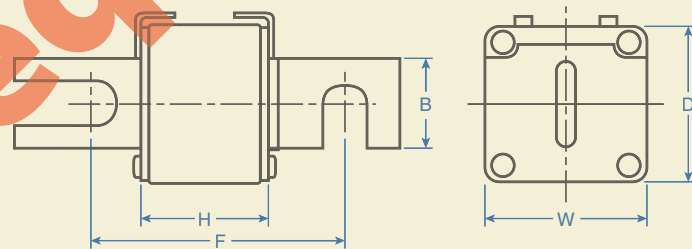
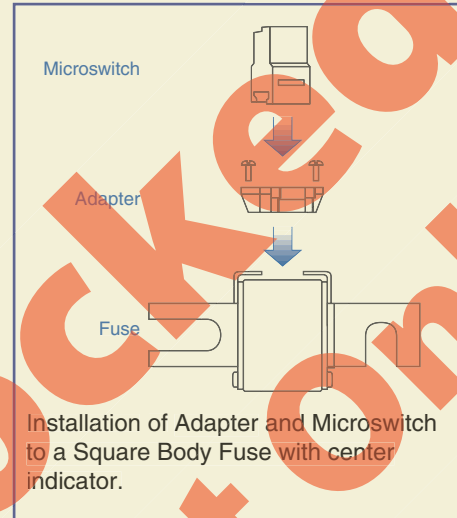

Approximate Dimensions
for Square Body Fuses mm (in.)*

Fuse Size	Body Width (W)	Body Depth (D)	Body Height (H)	Blade Depth (B)	Fixing Length** (F)
1	51 (2.00)	50 (1.97)	50 (1.97)	25 (0.98)	80 (3.15)
2	60 (2.36)	60 (2.36)	50 (1.97)	25 (0.98)	80 (3.15)
3	75 (2.95)	75 (2.95)	50 (1.97)	30 (1.18)	80 (3.15)

* Dimensions to DIN 43653

** Can be between 78mm (3.07 in.) and 80mm (3.15 in.)

SQUARE BODY Semiconductor

Square Body Fuses provide short circuit protection for semiconductor devices such as diodes, SCR's, etc. Fuses with knife blades are typically used in high power applications of 80 to 1000A at 660 or 1000V.

Square Body Fuses are available in three sizes with knife blades in two fixing lengths, 80mm (3.15 in.) and 110mm (4.33 in.). They can be supplied with a Flap Indicator or a Center Indicator for visual trip indication. The Center Indicator has a provision for mounting an Adapter and Microswitch for remote indication. Semiconductor Fuses offered comply with IEC, DIN and VDE.

Operating Class

aR - Partial Range Protection

(VDE 0636 / IEC 269)

Short circuit protection only.

Typical Markings: Ultra Rapid™, Silcu™, Protistor™, aR, 

Mostly red, orange, or blue imprint.



Square Body
With Knife Blade 110mm (4.33 in.)
Size 1
Class aR

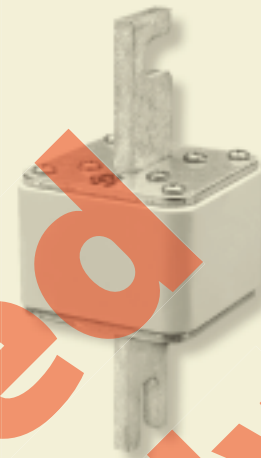

Square Body
With Knife Blade 110mm (4.33 in.)
Size 2
Class aR

Ordering Information	Current/ Voltage	Cat. No.	Dim.	Std. Pk.	Current/ Voltage	Cat. No.	Dim.	Std. Pk.	
Fuse with Flap Indicator up to 660V AC	80/660V AC	80SB1F1-6	A	1	400/660V AC	400SB2F1-6	C	1	
	100/660V AC	100SB1F1-6	A	1	450/660V AC	450SB2F1-6	C	1	
	125/660V AC	125SB1F1-6	A	1	500/660V AC	500SB2F1-6	C	1	
	160/660V AC	160SB1F1-6	A	1	550/660V AC	550SB2F1-6	C	1	
	200/660V AC	200SB1F1-6	A	1	630/660V AC	630SB2F1-6	C	1	
	250/660V AC	250SB1F1-6	A	1	700/660V AC	700SB2F1-6	C	1	
	315/660V AC	315SB1F1-6	A	1					
	350/660V AC	350SB1F1-6	A	1					
	400/660V AC	400SB1F1-6	A	1					
	450/660V AC	450SB1F1-6	A	1					
	500/660V AC	500SB1F1-6	A	1					
	Fuse with Center Indicator ¹ up to 660V AC	80/660V AC	80SB1C1-6	A	1	400/660V AC	400SB2C1-6	C	1
		100/660V AC	100SB1C1-6	A	1	450/660V AC	450SB2C1-6	C	1
125/660V AC		125SB1C1-6	A	1	500/660V AC	500SB2C1-6	C	1	
160/660V AC		160SB1C1-6	A	1	550/660V AC	550SB2C1-6	C	1	
200/660V AC		200SB1C1-6	A	1	630/660V AC	630SB2C1-6	C	1	
250/660V AC		250SB1C1-6	A	1	700/660V AC	700SB2C1-6	C	1	
315/660V AC		315SB1C1-6	A	1					
350/660V AC		350SB1C1-6	A	1					
400/660V AC		400SB1C1-6	A	1					
450/660V AC		450SB1C1-6	A	1					
500/660V AC		500SB1C1-6	A	1					
Fuse with Flap Indicator up to 1000V AC		200/1000V AC	200SB1F1-1	B	1	315/1000V AC	315SB2F1-1	D	1
		250/1000V AC	250SB1F1-1	B	1	350/1000V AC	350SB2F1-1	D	1
	315/1000V AC	315SB1F1-1	B	1	400/1000V AC	400SB2F1-1	D	1	
	350/1000V AC	350SB1F1-1	B	1	450/1000V AC	450SB2F1-1	D	1	
	400/1000V AC	400SB1F1-1	B	1	500/1000V AC	500SB2F1-1	D	1	
	450/1000V AC	450SB1F1-1	B	1	556/1000V AC	556SB2F1-1	D	1	
	500/1000V AC	500SB1F1-1	B	1	630/1000V AC	630SB2F1-1	D	1	
	Fuse with Center Indicator ¹ up to 1000V AC	200/1000V AC	200SB1C1-1	B	1	315/1000V AC	315SB2C1-1	D	1
250/1000V AC		250SB1C1-1	B	1	350/1000V AC	350SB2C1-1	D	1	
315/1000V AC		315SB1C1-1	B	1	400/1000V AC	400SB2C1-1	D	1	
350/1000V AC		350SB1C1-1	B	1	450/1000V AC	450SB2C1-1	D	1	
400/1000V AC		400SB1C1-1	B	1	500/1000V AC	500SB2C1-1	D	1	
450/1000V AC		450SB1C1-1	B	1	556/1000V AC	556SB2C1-1	D	1	
500/1000V AC		500SB1C1-1	B	1	630/1000V AC	630SB2C1-1	D	1	
Adapter ¹ See installation on pg 31		660V	SBA6		1	660V	SBA6		1
		1000V	SBA1		1	1000V	SBA1		1
Microswitch ² (SPDT) See installation on pg 31	6/250V AC	SBMS		1	6/250V AC	SBMS		1	

¹ We recommend the Adapter be used on Fuses with Center Indicators whether or not a Microswitch is used.

² An Adapter is required to mount the Microswitch. (Adapters will not fit on fuses with Flap Indicators)



**Square Body
With Knife Blade 110mm (4.33 in.)
Size 3
Class aR**

Current/ Voltage	Cat. No.	Dim.	Std. Pk.
500/660V AC	500SB3F1-6	E	1
550/660V AC	550SB3F1-6	E	1
630/660V AC	630SB3F1-6	E	1
700/660V AC	700SB3F1-6	E	1
800/660V AC	800SB3F1-6	E	1
900/660V AC	900SB3F1-6	E	1
1000/660V AC	1000SB3F1-6	E	1

500/660V AC	500SB3C1-6	E	1
550/660V AC	550SB3C1-6	E	1
630/660V AC	630SB3C1-6	E	1
700/660V AC	700SB3C1-6	E	1
800/660V AC	800SB3C1-6	E	1
900/660V AC	900SB3C1-6	E	1
1000/660V AC	1000SB3C1-6	E	1

500/1000V AC	500SB3F1-1	F	1
550/1000V AC	550SB3F1-1	F	1
630/1000V AC	630SB3F1-1	F	1
700/1000V AC	700SB3F1-1	F	1
800/1000V AC	800SB3F1-1	F	1
1000/1000V AC	1000SB3F1-1	F	1

500/1000V AC	500SB3C1-1	F	1
550/1000V AC	550SB3C1-1	F	1
630/1000V AC	630SB3C1-1	F	1
700/1000V AC	700SB3C1-1	F	1
800/1000V AC	800SB3C1-1	F	1
1000/1000V AC	1000SB3C1-1	F	1

660V	SBA6	1
1000V	SBA1	1

6/250V AC	SBMS	1
-----------	------	---

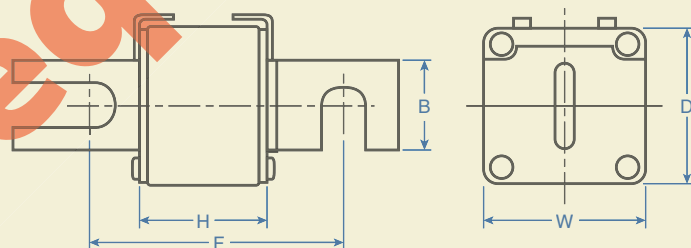
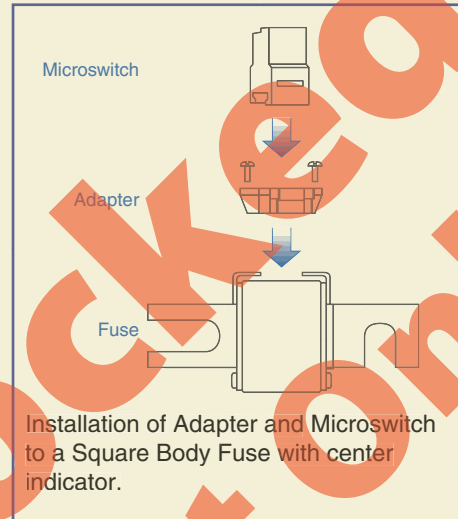

**Approximate Dimensions
for Square Body Fuses mm(in.)***

Fuse Size/Dim.	Body Width (W)	Body Depth (D)	Body Height (H)	Blade Depth (B)	Fixing Length** (F)
1/A	51 (2.01)	51 (2.01)	50 (1.97)	25 (.98)	110 (4.33)
1/B	51 (2.01)	51 (2.01)	73 (2.87)	25 (.98)	110 (4.33)
2/C	60 (2.36)	60 (2.36)	50 (1.97)	25 (.98)	110 (4.33)
2/D	60 (2.36)	60 (2.36)	73 (2.87)	25 (.98)	110 (4.33)
3/E	75 (2.95)	75 (2.95)	50 (1.97)	30 (1.18)	110 (4.33)
3/F	75 (2.95)	75 (2.95)	73 (2.87)	30 (1.18)	110 (4.33)

*Dimensions to DIN 43653

** Can be between 108mm (4.25) and 110mm (4.33)

HIGH VOLTAGE

High Voltage Fuses are typically used in distribution circuits and can be used for indoor or outdoor applications. They are available in four lengths and four different voltage ranges. Fuses supplied standardly with Striker Pins.

Example: 3 / 7.2KV High Voltage Fuses can be used on systems that operate on 3KV Voltage to 7.2KV Voltage. (3KV is the lower rated voltage and 7.2KV is the higher rated voltage.)

The High Voltage Fuses offered comply with IEC, DIN and VDE. Please consult Altech for 3 / 3.6KV, 17.5KV Fuses and also for High Voltage fuses which comply with BS 2692 and FSI 12-8 standards.

(IEC 282-1 / VDE 0670)



3 / 7.2KV

Ordering Information

192mm (7.56 in.) Length (L) Fuse

Rated Current	Cat No.	Dim.	Std. Pk.
6A	6HH7.2-192	D	1
10A	10HH7.2-192	D	1
16A	16HH7.2-192	D	1
20A	20HH7.2-192	D	1
25A	25HH7.2-192	D	1
30A	30HH7.2-192	D	1
40A	40HH7.2-192	D	1
50A	50HH7.2-192	D	1
63A	63HH7.2-192	E	1
80A	80HH7.2-192	E	1
100A	100HH7.2-192	E ¹	1
125A	125HH7.2-192	F	1
160A	160HH7.2-192	F	1
200A	200HH7.2-192	F	1
250A	250HH7.2-192	F	1

292mm (11.50 in.) Length (L) Fuse

6A	6HH7.2-292	A	1
10A	10HH7.2-292	A	1
16A	16HH7.2-292	A	1
20A	20HH7.2-292	A	1
25A	25HH7.2-292	A	1
30A	30HH7.2-292	A	1
40A	40HH7.2-292	A	1
50A	50HH7.2-292	A	1
63A	63HH7.2-292	B	1
80A	80HH7.2-292	B	1
100A	100HH7.2-292	B	1
125A	125HH7.2-292	C	1
160A	160HH7.2-292	C	1
200A	200HH7.2-292	C	1
250A	250HH7.2-292	C	1
315A	315HH7.2-292	C	1
355A	355HH7.2-292	C	1

442mm (17.40 in.) Length (L) Fuse

100A	100HH7.2-442	G	1
125A	125HH7.2-442	G	1
160A	160HH7.2-442	G	1
200A	200HH7.2-442	G	1
250A	250HH7.2-442	G	1
315A	315HH7.2-442	G	1
355A	355HH7.2-442	G	1
400A	400HH7.2-442	G	1
500A	500HH7.2-442	G	1

537mm (21.14 in.) Length (L) Fuse

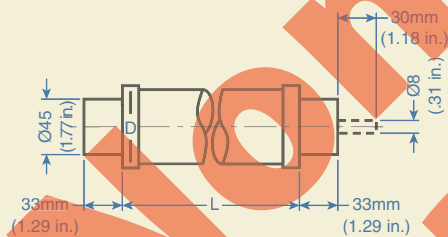

Approximate Dimensions for High Voltage Fuses mm (in.)*

Fuse Dim.	Diameter (D)	Fuse Dim.	Diameter (D)
A	53 (2.09)	F	85 (3.35)
B	67 (2.64)	G	85 (3.35)
C	85 (3.35)	H	53 (2.09)
D	53 (2.09)	I	67 (2.64)
E	67 (2.64)	J	85 (3.35)
		K	53 (2.09)

¹ Also available with a 85mm (3.35 in.) diameter.
* Dimension to DIN 43625



6 / 12KV



10 / 24KV

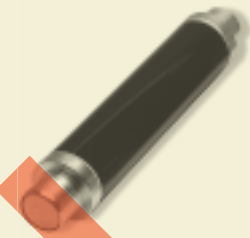

20 / 36KV

Rated Current **Cat No.** **Dim.** **Std. Pk.**

6A	6HH12-292	A	1
10A	10HH12-292	A	1
16A	16HH12-292	A	1
20A	20HH12-292	A	1
25A	25HH12-292	A	1
30A	30HH12-292	A	1
40A	40HH12-292	A	1
50A	50HH12-292	A	1
63A	63HH12-292	B	1
80A	80HH12-292	B	1
100A	100HH12-292	B	1
125A	125HH12-292	C	1
160A	160HH12-292	C	1
200A	200HH12-292	C	1

6A	6HH12-442	H	1
10A	10HH12-442	H	1
16A	16HH12-442	H	1
20A	20HH12-442	H	1
25A	25HH12-442	H	1
30A	30HH12-442	H	1
40A	40HH12-442	H	1
50A	50HH12-442	H	1
63A	63HH12-442	I	1
80A	80HH12-442	I	1
100A	100HH12-442	I	1
125A	125HH12-442	G	1
160A	160HH12-442	G	1
200A	200HH12-442	G	1
250A	250HH12-442	G	1

100A	100HH12-537	J	1
125A	125HH12-537	J	1
160A	160HH12-537	J	1
200A	200HH12-537	J	1
250A	250HH12-537	J	1
315A	315HH12-537	J	1

Rated Current **Cat No.** **Dim.** **Std. Pk.**

6A	6HH24-442	H	1
10A	10HH24-442	H	1
16A	16HH24-442	H	1
20A	20HH24-442	H	1
25A	25HH24-442	H	1
30A	30HH24-442	H	1
40A	40HH24-442	H	1
50A	50HH24-442	I	1
63A	63HH24-442	I	1
80A	80HH24-442	I	1
100A	100HH24-442	G	1
125A	125HH24-442	G	1

6A	6HH24-537	K	1
10A	10HH24-537	K	1
16A	16HH24-537	K	1
20A	20HH24-537	K	1
25A	25HH24-537	K	1
30A	30HH24-537	K	1
40A	40HH24-537	K	1
50A	50HH24-537	L	1
63A	63HH24-537	L	1
80A	80HH24-537	L	1
100A	100HH24-537	J	1
125A	125HH24-537	J	1
160A	160HH24-537	J	1
200A	200HH24-537	J	1

Rated Current **Cat No.** **Dim.** **Std. Pk.**

6A	6HH36-537	K	1
10A	10HH36-537	K	1
16A	16HH36-537	K	1
20A	20HH36-537	K	1
25A	25HH36-537	K	1
30A	30HH36-537	L	1
40A	40HH36-537	L	1
50A	50HH36-537	J	1
63A	63HH36-537	J	1

SIEMENS / ALTECH FUSE CROSS REFERENCE

Note: Not all crosses are 100% identical but all are sufficient substitutes for fit, form and function.

Siemens No.	Altech No.	Siemens No.	Altech No.	Siemens No.	Altech No.	Siemens No.	Altech No.
3NA1431-6	355NH3GL-6	3NA3003	10NH0GL	3NA3807-6	20NH00GL-6	3NE1030-0	315NH2AR-6
3NA1432-6	400NH3GL-6	3NA3005	16NH0GL	3NA3810-6	25NH00GL-6	3NE1031-0	355NH2AR-6
3NA1434-6	500NH3GL-6	3NA3007	20NH0GL	3NA3812-6	32NH00GL-6	3NE1032-0	400NH2AR-6
		3NA3010	25NH0GL	3NA3814-6	35NH00GL-6		
3NA2105	16NH1GL-ISO	3NA3012	32NH0GL	3NA3817-6	40NH00GL-6	3NE1813-0	16NH00GR-6
3NA2107	20NH1GL-ISO	3NA3014	35NH0GL	3NA3820-6	50NH00GL-6	3NE1814-0	20NH00GR-6
3NA2110	25NH1GL-ISO	3NA3017	40NH0GL			3NE1815-0	25NH00GR-6
3NA2114	35NH1GL-ISO	3NA3020	50NH0GL	3NA3822-6	63NH00GL-6	3NE1803-0	35NH00GR-6
3NA2117	40NH1GL-ISO	3NA3022	63NH0GL	3NA3824-6	80NH00GL-6	3NE1802-0	40NH00GR-6
3NA2120	50NH1GL-ISO	3NA3024	80NH0GL	3NA3830-6	100NH00GL-6	3NE1817-0	50NH00GR-6
3NA2122	63NH1GL-ISO	3NA3030	100NH0GL			3NE1818-0	63NH00GR-6
3NA2124	80NH1GL-ISO	3NA3032	125NH0GL	3NA3802	2NH00GL	3NE1820-0	80NH00GR-6
3NA2130	100NH1GL-ISO	3NA3036	160NH0GL	3NA3804	4NH00GL		
3NA2132	125NH1GL-ISO			3NA3801	6NH00GL	3NE3221	100NH1BGR-1
3NA2136	160NH1GL-ISO	3NA3120-6	50NH1GL-6	3NA3803	10NH00GL	3NE3222	125NH1BGR-1
3NA2140	200NH1GL-ISO	3NA3122-6	63NH1GL-6	3NA3805	16NH00GL	3NE3224	160NH1BAR-1
3NA2142	224NH1GL-ISO	3NA3124-6	80NH1GL-6	3NA3807	20NH00GL	3NE3225	200NH1BAR-1
3NA2144	250NH1GL-ISO	3NA3130-6	100NH1GL-6	3NA3810	25NH00GL	3NE3227	250NH1BAR-1
		3NA3132-6	125NH1GL-6	3NA3812	32NH00GL		
3NA2120-6	50NH1GL-6-ISO	3NA3136-6	160NH1GL-6	3NA3814	35NH00GL	3NE3230-0B	315SB1F1-1
3NA2122-6	63NH1GL-6-ISO	3NA3140-6	200NH1GL-6	3NA3817	40NH00GL	3NE3231	350SB1F1-1
3NA2124-6	80NH1GL-6-ISO			3NA3820	50NH00GL	3NE3232-0B	400SB1F1-1
3NA2130-6	100NH1GL-6-ISO	3NA3105	16NH1GL	3NA3822	63NH00GL	3NE3233	450SB1F1-1
3NA2132-6	125NH1GL-6-ISO	3NA3107	20NH1GL	3NA3824	80NH00GL		
3NA2136-6	160NH1GL-6-ISO	3NA3110	25NH1GL	3NA3830	100NH00GL	3NE3421	100NH3BAR-1
3NA2140-6	200NH1GL-6-ISO	3NA3114	35NH1GL	3NA3832	125NH00GL	3NE3425	224NH3BAR-1
		3NA3117	40NH1GL	3NA3836	160NH00GL	3NE3626	224NH3BAR-1
3NA2224-6	80NH2GL-6-ISO	3NA3120	50NH1GL			3NE3430	315NH3BAR-1
3NA2230-6	100NH2GL-6-ISO	3NA3122	63NH1GL	3NC 2423	150NH3BGR-6	3NE3431	350NH3BAR-1
3NA2232-6	125NH2GL-6-ISO	3NA3124	80NH1GL	3NC 2425	200NH3BGR-6	3NE3635	450NH3BAR-1
3NA2236-6	160NH2GL-6-ISO	3NA3130	100NH1GL	3NC 2427	250NH3BGR-6	3NE3434	500NH3BAR-1
3NA2240-6	200NH2GL-6-ISO	3NA3132	125NH1GL	3NC 2428	300NH3BGR-6		
		3NA3136	160NH1GL	3NC 2431	350NH3BGR-6	3NE4101	32NH0GR-1
3NA2214	35NH2GL-ISO	3NA3140	200NH1GL	3NC 2432	400NH3BGR-6	3NE4102	40NH0GR-1
3NA2220	50NH2GL-ISO	3NA3142	224NH1GL			3NE4117	50NH0GR-1
3NA2222	63NH2GL-ISO	3NA3144	250NH1GL	3NC 8423	150NH3BGR-6	3NE4118	63NH0AR-1
3NA2224	80NH2GL-ISO			3NC 8425	200NH3BGR-6	3NE4120	80NH0AR-1
3NA2230	100NH2GL-ISO	3NA3214	35NH2GL	3NC 8427	250NH3BGR-6	3NE4121	100NH0AR-1
3NA2232	125NH2GL-ISO	3NA3220	50NH2GL	3NC 8431	350NH3BGR-6	3NE4122	125NH0AR-1
3NA2236	160NH2GL-ISO	3NA3222	63NH2GL	3NC 8434	500NH3BGR-6	3NE4124	160NH0AR-1
3NA2240	200NH2GL-ISO	3NA3224	80NH2GL			3NE4126	160NH0AR-1
3NA2242	224NH2GL-ISO	3NA3230	100NH2GL	3ND1122	63NH1AM-6		
3NA2244	250NH2GL-ISO	3NA3232	125NH2GL	3ND1124	80NH1AM-6	3NE7425	200NH3BAR-2
3NA2250	300NH2GL-ISO	3NA3236	160NH2GL	3ND1130	100NH1AM-6	3NE7427	250NH3BAR-2
3NA2252	315NH2GL-ISO	3NA3240	200NH2GL	3ND1132	125NH1AM-6	3NE7431	350NH3BAR-2
3NA2254	355NH2GL-ISO	3NA3242	224NH2GL	3ND1136	160NH1AM-6	3NE7432	400NH3BAR-2
3NA2260	400NH2GL-ISO	3NA3244	250NH2GL	3ND1140	200NH1AM-6	3NE7633	450NH3BAR-2
		3NA3250	300NH2GL	3ND1144	250NH1AM-6		
3NA2802	2NH00GL-ISO	3NA3252	315NH2GL			3NE8015	25NH00GR-6
3NA2804	4NH00GL-ISO	3NA3254	355NH2GL	3ND1232	125NH2AM-6	3NE8003	35NH00GR-6
3NA2801	6NH00GL-ISO	3NA3260	400NH2GL	3ND1236	160NH2AM-6	3NE8017	50NH00GR-6
3NA2803	10NH00GL-ISO			3ND1240	200NH2AM-6	3NE8018	63NH00GR-6
3NA2805	16NH00GL-ISO	3NA3224-6	80NH2GL-6	3ND1244	250NH2AM-6	3NE8020	80NH00GR-6
3NA2807	20NH00GL-ISO	3NA3230-6	100NH2GL-6	3ND1252	315NH2AM-6	3NE8021	100NH0GR-6
3NA2810	25NH00GL-ISO	3NA3232-6	125NH2GL-6	3ND1254	355NH2AM-6	3NE8022	125NH00GR-6
3NA2812	32NH00GL-ISO	3NA3236-6	160NH2GL-6	3ND1260	400NH2AM-6	3NE8024	160NH00AR-6
3NA2814	35NH00GL-ISO	3NA3240-6	200NH2GL-6				
3NA2817	40NH00GL-ISO	3NA3244-6	250NH2GL-6	3ND1352	315NH3AM-6	3NE8701	32SM00CAR-L
3NA2820	50NH00GL-ISO	3NA3252-6	315NH2GL-6	3ND1354	355NH3AM-6	3NE8702	40SM00CAR-L
3NA2822	63NH00GL-ISO			3ND1460	400NH3AM-6	3NE8714	20SM00CAR-L
3NA2824	80NH00GL-ISO	3NA3354-6	355NH3GL-6	3ND1365	500NH3AM-6	3NE8715	25SM00CAR-L
3NA2830	100NH00GL-ISO	3NA3360-6	400NH3GL-6	3ND1372	630NH3AM-6	3NE8717	50SM00CAR-L
3NA2832	125NH00GL-ISO	3NA3365-6	500NH3GL-6			3NE8718	63SM00CAR-L
3NA2836	160NH00GL-ISO			3ND1803	10NH00AM-6	3NE8720	80SM00CAR-L
		3NA3344	250NH3GL	3ND1805	16NH00AM-6	3NE8721	100SM00CAR-L
3NA2802-6	2NH00GL-6-ISO	3NA3350	300NH3GL	3ND1807	20NH00AM-6	3NE8722	125SM00CAR-L
3NA2804-6	4NH00GL-6-ISO	3NA3352	315NH3GL	3ND1810	25NH00AM-6	3NE8724	160SM00CAR-L
3NA2801-6	6NH00GL-6-ISO	3NA3354	355NH3GL	3ND1812	32NH00AM-6	3NE8725	200SM00CAR-L
3NA2803-6	10NH00GL-6-ISO	3NA3360	400NH3GL	3ND1814	35NH00AM-6	3NE8727	250SM00CAR-L
3NA2805-6	16NH00GL-6-ISO	3NA3365	500NH3GL	3ND1817	40NH00AM-6	3NE8731	315SM00CAR-L
3NA2807-6	20NH00GL-6-ISO	3NA3372	630NH3GL	3ND1820	50NH00AM-6		
3NA2810-6	25NH00GL-6-ISO			3ND1822	63NH00AM-6	3NH3030	NHB00-1
3NA2812-6	32NH00GL-6-ISO	3NA3665	500NH4GL	3ND1824	80NH00AM-6	3NH3120	NHB0-1
3NA2814-6	35NH00GL-6-ISO	3NA3672	630NH4GL	3ND1830	100NH00AM-6	3NH3230	NHB1-1
3NA2817-6	40NH00GL-6-ISO	3NA3675	800NH4GL	3ND1832	125NH00AM-6	3NH3330	NHB2-1
3NA2820-6	50NH00GL-6-ISO	3NA3680	1000NH4GL	3ND1836	160NH00AM-6	3NH3430	NHB3-1
3NA2822-6	63NH00GL-6-ISO	3NA3682	1250NH4GL			3NH4030	NHB00-3
3NA2824-6	80NH00GL-6-ISO			3NE1021-0	100NH00GR-6	3NH4230	NHB1-3
3NA2830-6	100NH00GL-6-ISO	3NA3802-6	2NH00GL-6	3NE1022-0	125NH00GR-6	3NH7520	NHB4A-1
		3NA3804-6	4NH00GL-6				
3NA3001	6NH0GL	3NA3801-6	6NH00GL-6	3NE1024-0	160NH1AR-6		
3NA3002	10NH0GL	3NA3803-6	10NH00GL-6	3NE1025-0	200NH1AR-6		
		3NA3805-6	16NH00GL-6	3NE1027-0	250NH1AR-6		

Siemens No.	Altech No.	Siemens No.	Altech No.	Siemens No.	Altech No.	Siemens No.	Altech No.
3NW6002-1	2C10x38GI	3NW8203-1	10C22x58AM	5SD601	2D33FB-7	5SH310	D27AS02
3NW6004-1	4C10x38GI	3NW8205-1	16C22x58AM	5SD602	4D33FB-7	5SH311	D27AS04
3NW6001-1	6C10x38GI	3NW8207-1	20C22x58AM	5SD603	6D33FB-7	5SH312	D27AS06
3NW6008-1	8C10x38GI	3NW8210-1	25C22x58AM	5SD604	10D33FB-7	5SH313	D27AS10
3NW6003-1	10C10x38GI	3NW8212-1	32C22x58AM	5SD605	16D33FB-7	5SH314	D27AS16
3NW6006-1	12C10x38GI	3NW8217-1	40C22x58AM	5SD606	20D33FB-7	5SH315	D27AS20
3NW6005-1	16C10x38GI	3NW8220-1	50C22x58AM	5SD607	25D33FB-7	5SH316	D27AS25
3NW6007-1	20C10x38GI	3NW8222-1	63C22x58AM	5SD608	35D33FB-7		
3NW6010-1	25C10x38GI	3NW8224-1	80C22x58AM	5SD610	50D33FB-7	5SH3703	DAT
		3NW8230-1	100C22x58AM	5SD611	63D33FB-7		
3NW6104-1	4C14x51GI					5SH4316	NZ01C
3NW6101-1	6C14x51GI	3NX2023	NHEP0	5SD8002	2D33SB-6	5SH4363	NZ02C
3NW6108-1	8C14x51GI	3NX2030	NHEP0	5SD8004	4D33SB-6	5SH4100	NZ03C
3NW6103-1	10C14x51GI	3NX2024	NHEP1	5SD8006	6D33SB-6		
3NW6106-1	12C14x51GI	3NX2025	NHEP2	5SD8010	10D33SB-6	5SH5002	NZ01AR02
3NW6105-1	16C14x51GI	3NX2026	NHEP3	5SD8016	16D33SB-6	5SH5004	NZ01AR04
3NW6107-1	20C14x51GI			5SD8016	20D33SB-6	5SH5006	NZ01AR06
3NW6110-1	25C14x51GI	3NX3105	NHTC00	5SD8020	25D33SB-6	5SH5010	NZ01AR10
3NW6112-1	32C14x51GI			5SD8025	35D33SB-6	5SH5020	NZ02AR20
3NW6117-1	40C14x51GI	3NX1011	NHHA	5SD8035	50D33SB-6	5SH5025	NZ02AR25
3NW6120-1	50C14x51GI			5SD8050	63D33SB-6	5SH5035	NZ02AR35
		3NX1012	NHSG	5SD8063		5SH5050	NZ02AR50
						5SH5080	NZ03AR80
3NW6208-1	8C22x58GI	5SA111	2D16FB	5SE2002	2NZ01GL	5SH5100	NAT
3NW6203-1	10C22x58GI	5SA121	4D16FB	5SE2004	4NZ01GL		
3NW6216-1	12C22x58GI	5SA131	6D16FB	5SE2006	6NZ01GL		
3NW6205-1	16C22x58GI	5SA151	10D16FB	5SE2010	10NZ01GL	5SH5231	NZ01BC
3NW6207-1	20C22x58GI	5SA161	16D16FB	5SE2016	16NZ01GL	5SH5233	NZ02BC
3NW6210-1	25C22x58GI	5SA171	20D16FB				NZ03BC
3NW6212-1	32C22x58GI	5SA181	25D16FB	5SE2020	20NZ02GL		
3NW6217-1	40C22x58GI			5SE2025	25NZ02GL	5SH5232	NZ01BC3
3NW6220-1	50C22x58GI	5SA211	2D16SB	5SE2035	35NZ02GL	5SH5232	NZ02BC3
3NW6222-1	63C22x58GI	5SA221	4D16SB	5SE2050	50NZ02GL		
3NW6224-1	80C22x58GI	5SA231	6D16SB	5SE2063	63NZ02GL		
3NW6230-1	100C22x58GI	5SA251	10D16SB				
		5SA261	16D16SB	5SE2080	80NZ03GL		
3NW6302-1	2C8x32GI	5SA271	20D16SB	5SE2100	100NZ03GL		
3NW6304-1	4C8x32GI	5SA281	25D16SB				
3NW6301-1	6C8x32GI			5SE2202	2NZ01GL		
3NW6303-1	10C8x32GI	5SB111	2D27FB	5SE2204	4NZ01GL		
3NW6306-1	12C8x32GI	5SB121	4D27FB	5SE2206	6NZ01GL		
3NW6305-1	16C8x32GI	5SB131	6D27FB	5SE2210	10NZ01GL		
3NW6307-1	20C8x32GI	5SB151	10D27FB	5SE2216	16NZ01GL		
		5SB161	16D27FB	5SE2220	20NZ02GL		
3NW7010	CB1038-1	5SB171	20D27FB	5SE2225	25NZ02GL		
3NW7050	CB1038-1N	5SB181	25D27FB	5SE2235	35NZ02GL		
3NW7020	CB1038-2			5SE2250	50NZ02GL		
3NW7030	CB1038-3	5SB211	2D27SB	5SE2263	63NZ02GL		
3NW7060	CB1038-3N	5SB221	4D27SB	5SE2280	80NZ03GL		
3NW7110	CB1451-1	5SB231	6D27SB	5SE2300	100NZ03GL		
3NW7150	CB1451-1N	5SB251	10D27SB				
3NW7120	CB1451-2	5SB261	16D27SB	5SF1012	D16B		
				5SF1005	D27B		
3NW7130	CB1451-3	5SB271	20D27SB	5SF1215	D33B		
3NW7160	CB1451-3N	5SB281	25D27SB	5SF1242	D33B		
3NW7210	CB2258-1	5SB311	35D33FB	5SF5081	D27B3		
3NW7250	CB2258-1N	5SB321	50D33FB	5SF5241	D33B3		
3NW7220	CB2258-2	5SB331	63D33FB				
3NW7230	CB2258-3			5SG1582	NZ01B		
3NW7260	CB2258-3N	5SB411	35D33SB	5SG1672	NZ02B		
		5SB421	50D33SB	5SG1682	NZ02B		
		5SB431	63D33SB				
3NW8011-1	1C10x38AM			5SG1812	NZ03B		
3NW8002-1	2C10x38AM	5SC111	80D1.25FB	5SG5672	NZ02B3		
3NW8004-1	4C10x38AM	5SC121	100D1.25FB				
3NW8001-1	6C10x38AM			5SG5572	NZ01B3		
3NW8008-1	8C10x38AM	5SC211	80D1.25SB	5SG5682	NZ02B3		
3NW8003-1	10C10x38AM	5SC221	100D1.25SB				
3NW8005-1	16C10x38AM			5SH111	D16C		
3NW8007-1	20C10x38AM	5SD420	16D27SC	5SH112	D27C		
3NW8010-1	25C10x38AM	5SD430	20D27SC	5SH113	D33C		
		5SD440	25D27SC	5SH122	D27C		
		5SD480	30D27SC	5SH123	D33C		
3NW8102-1	2C14x51AM			5SH124	D1.25C		
3NW8104-1	4C14x51AM						
3NW8101-1	6C14x51AM	5SD450	35D33SC				
3NW8108-1	8C14x51AM	5SD460	50D33SC	5SH2032	D27BC		
3NW8103-1	10C14x51AM	5SD470	63D33SC	5SH2232	D33BC		
3NW8105-1	16C14x51AM						
3NW8107-1	20C14x51AM	5SD510	80D1.25SC				
3NW8110-1	25C14x51AM	5SD520	100D1.25SC				
3NW8112-1	32C14x51AM						
3NW8117-1	40C14x51AM						
3NW8120-1	50C14x51AM						



Компания «ЭлектроПласт» предлагает заключение долгосрочных отношений при поставках импортных электронных компонентов на взаимовыгодных условиях!

Наши преимущества:

- Оперативные поставки широкого спектра электронных компонентов отечественного и импортного производства напрямую от производителей и с крупнейших мировых складов;
- Поставка более 17-ти миллионов наименований электронных компонентов;
- Поставка сложных, дефицитных, либо снятых с производства позиций;
- Оперативные сроки поставки под заказ (от 5 рабочих дней);
- Экспресс доставка в любую точку России;
- Техническая поддержка проекта, помощь в подборе аналогов, поставка прототипов;
- Система менеджмента качества сертифицирована по Международному стандарту ISO 9001;
- Лицензия ФСБ на осуществление работ с использованием сведений, составляющих государственную тайну;
- Поставка специализированных компонентов (Xilinx, Altera, Analog Devices, Intersil, Interpoint, Microsemi, Aeroflex, Peregrine, Syfer, Eurofarad, Texas Instrument, Miteq, Cobham, E2V, MA-COM, Hittite, Mini-Circuits, General Dynamics и др.);

Помимо этого, одним из направлений компании «ЭлектроПласт» является направление «Источники питания». Мы предлагаем Вам помощь Конструкторского отдела:

- Подбор оптимального решения, техническое обоснование при выборе компонента;
- Подбор аналогов;
- Консультации по применению компонента;
- Поставка образцов и прототипов;
- Техническая поддержка проекта;
- Защита от снятия компонента с производства.



Как с нами связаться

Телефон: 8 (812) 309 58 32 (многоканальный)

Факс: 8 (812) 320-02-42

Электронная почта: org@eplast1.ru

Адрес: 198099, г. Санкт-Петербург, ул. Калинина, дом 2, корпус 4, литера А.