

# RFDA4005

6-Bit, Digital Controlled Variable Gain Amplifier  
50MHz to 4000MHz

RFMD's RFDA4005 is a digitally controlled variable gain amplifier featuring high linearity over the entire gain control range with noise figure less than 6dB in its maximum gain state. The gain of the 6-bit digital step attenuator is programmed with a serial mode control interface. The RFDA4005 is packaged in a small 5.2mm x 5.2mm leadless laminate MCM which contains plated through thermal vias for ultra-low thermal resistance. The footprint for this module is directly compatible with a 5mm x 5mm QFN. This module is easy to use with no external matching components required.



Package: MCM, 32-pin,  
5.2mm x 5.2mm

## Features

- Broadband 50MHz to 4000MHz Operation
- 6-Bit Digital Step Attenuator
- Serial Mode Programming
- Gain = -13.5dB to +18dB (0.5dB Step Size)
- High Output IP3/P1dB = +36dB/20dBm
- Single +5V Supply
- Small 32-Pin, 5.2mm x 5.2mm, MCM (Footprint Compatible with 5mm x 5mm, 32-Pin QFN)

## Applications

- Cellular, 3G Infrastructure
- WiBro, WiMax, LTE
- Microwave Radio
- High Linear Power Control

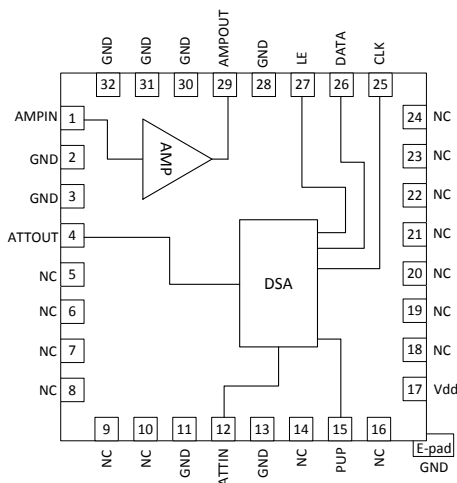

Functional Block Diagram

## Ordering Information

RFDA4005SQ	Sample bag with 25 pieces
RFDA4005SR	7" Reel with 100 pieces
RFDA4005TR13	13" Reel with 2500 pieces
RFDA4005PCK-410	50MHz to 4000MHz PCBA with 5-piece sample bag

## Absolute Maximum Ratings

Parameter	Rating	Unit
Supply Voltage	5.5	V
DC Supply Current	110	mA
Power Dissipation	605	mW
Maximum RF Input Power	20	dBm
Storage Temperature Range	-40 to +150	°C
ESD Rating – HBM	1000 (Class 1C)	V
ESD Rating – CDM	1000 (Class 3C)	V
Moisture Sensitivity Level	MSL3	



**Caution!** ESD sensitive device.



RFMD Green: RoHS status based on EU Directive 2011/65/EU (at time of this document revision), halogen free per IEC 61249-2-21, < 1000ppm each of antimony trioxide in polymeric materials and red phosphorus as a flame retardant, and <2% antimony in solder.

Exceeding any one or a combination of the Absolute Maximum Rating conditions may cause permanent damage to the device. Extended application of Absolute Maximum Rating conditions to the device may reduce device reliability. Specified typical performance or functional operation of the device under Absolute Maximum Rating conditions is not implied.

## Recommended Operating Condition

Parameter	Specification			Unit
	Min	Typ	Max	
Operating Temperature Range	-40		+85	°C
Operating Junction Temperature <sup>1</sup>			165	°C
Supply Voltage	4.75	5	5.25	V

Note 1: MTTF = 1.0E6 hours at 165°C junction temperature

## Nominal Operating Parameters

Parameter	Specification			Unit	Condition
	Min	Typ	Max		
<b>General Performance</b>					<b>Temp = 25°C, V<sub>DD</sub> = 5V</b>
Frequency Range	50		4000	MHz	
Gain Max	17.5	19	20.5	dB	500MHz, 0dB attenuation
	15.5	17.5	18.5	dB	2700MHz
Step Accuracy	+ (0.1+5% Attenuation Setting)			dB	
Output P1dB		20		dBm	1900MHz
		19		dBm	2700MHz
Output IP3		36		dBm	1900MHz
		33		dBm	2700MHz
Control Interface		6		Bit	Serial mode
Settling Time		250		nsec	T <sub>ON</sub> , T <sub>OFF</sub> (10 / 90% RF)
Noise Figure		6.3		dB	1900MHz
Impedance		50		Ω	
Input Return Loss		-15		dB	

Parameter	Specification			Unit	Condition
	Min	Typ	Max		
<b>General Performance</b>					<b>Temp = 25°C, V<sub>DD</sub> = 5V</b>
Output Return Loss		-15		dB	
Supply Current		82		mA	
Thermal Resistance		80.7		°C/W	Junction to backside of device

### Typical RF Performance at Key Operating Frequencies

Parameter	Unit	500MHz	850MHz	1.95GHz	2.4GHz	3.5GHz	4GHz
Maximum Small Signal Gain	dB	18.9	18.7	17.6	17.2	15.7	13.7
Output P1dB	dBm	20.5	20.4	20.4	19.4	16.9	14.7
Output IP3	dBm	39	40	36	34.8	28.5	27.1
Input Return Loss	dB	-36	-24	-16	-15	-14	-10
Output Return Loss	dB	-18	-22	-15	-11	-16	-27
Noise Figure	dB	5.5	5.5	5.9	6.2	8.3	10

Typical Application Schematic 50MHz to 4000MHz Application Circuit

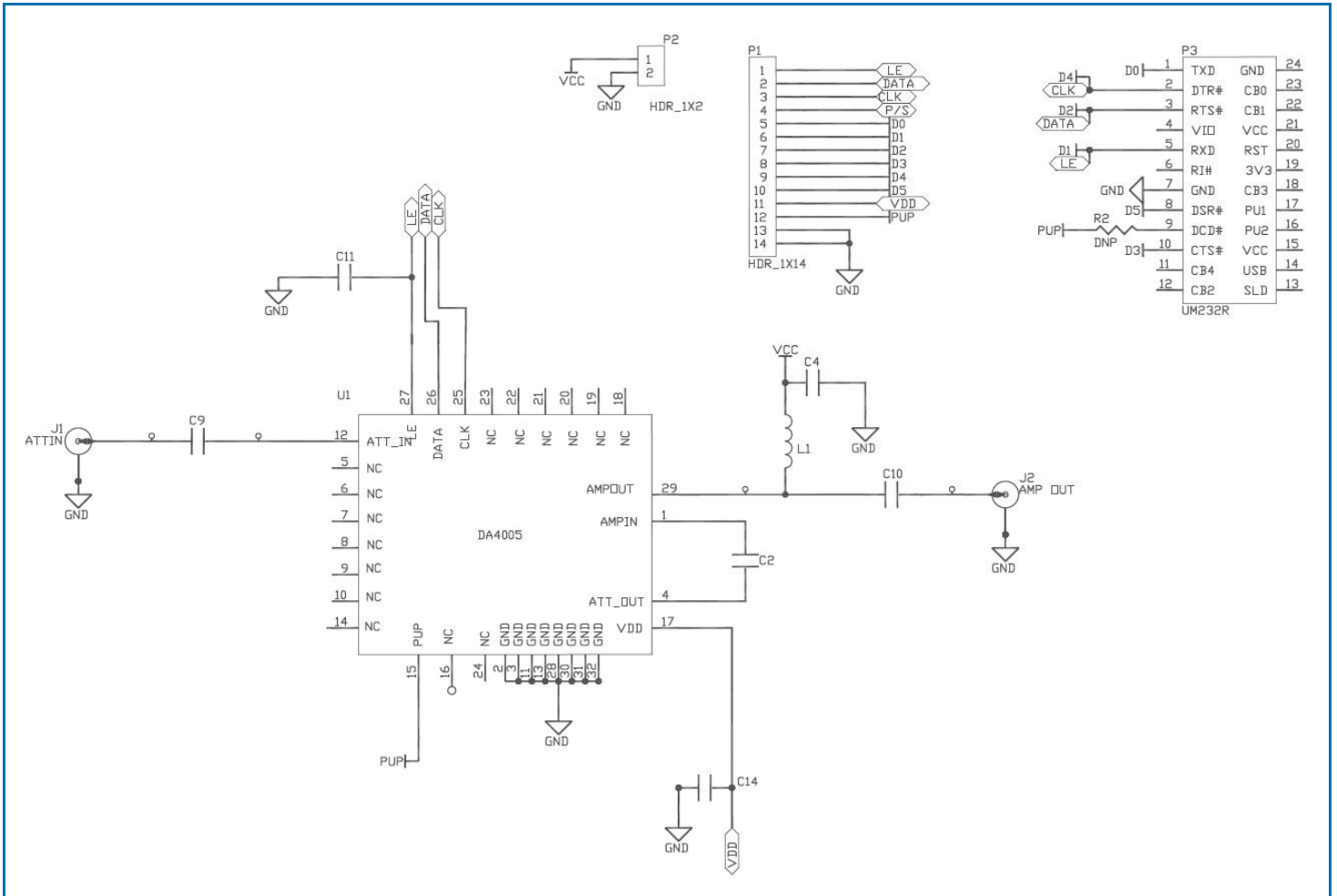

Typical Performance: T = 25°C, V<sub>DD</sub> = 5V unless otherwise noted

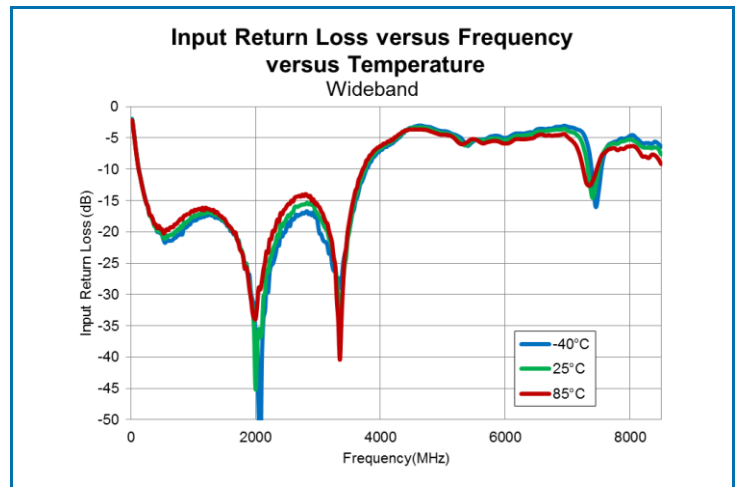
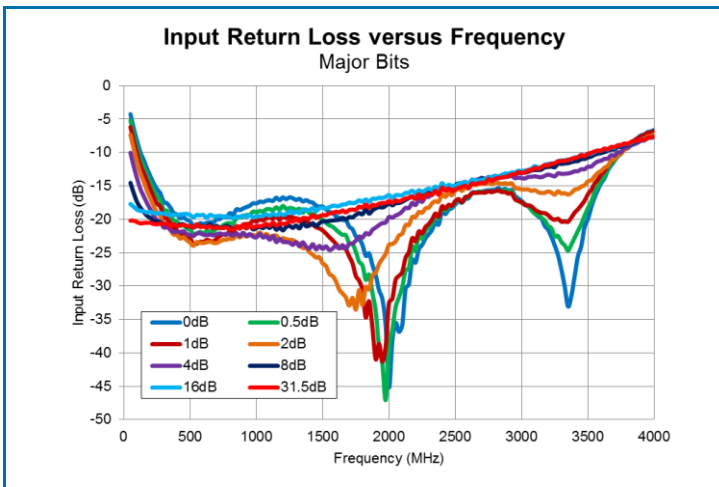
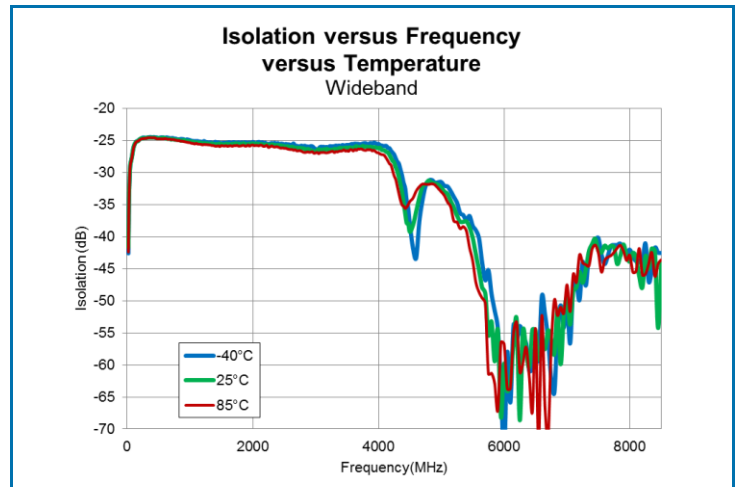
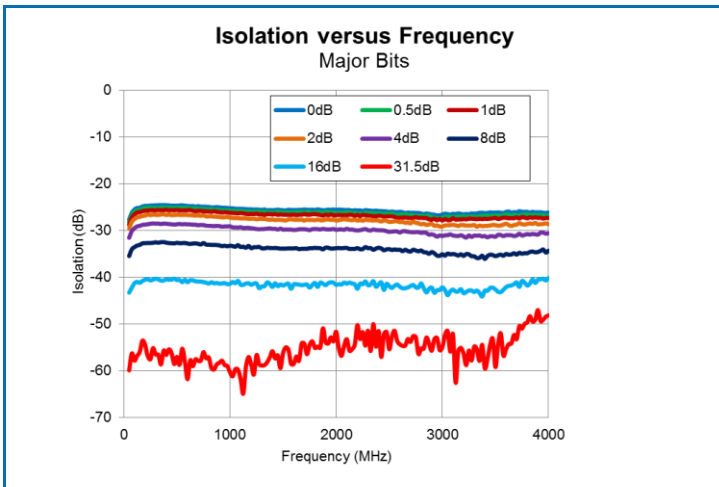
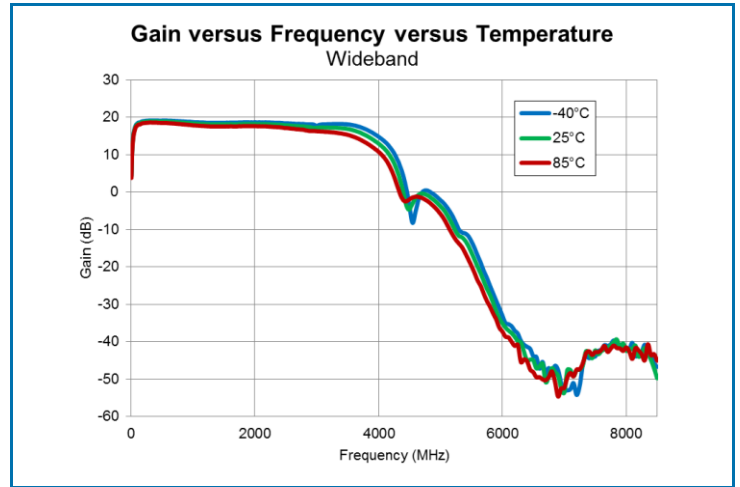
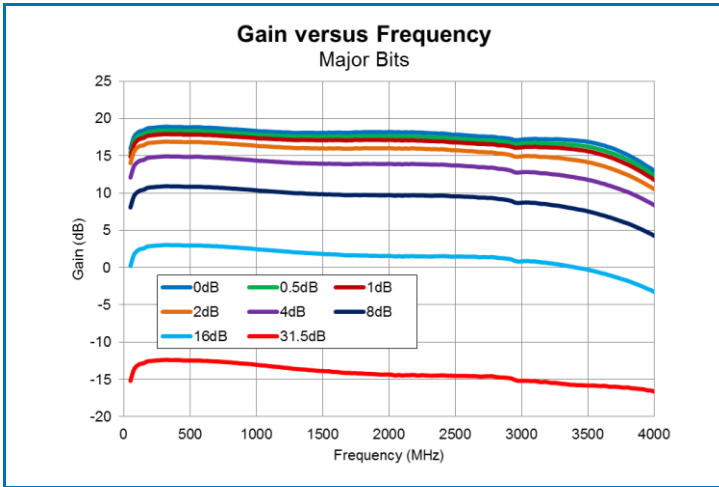

Typical Performance: T = 25°C, V<sub>DD</sub> = 5V unless otherwise noted

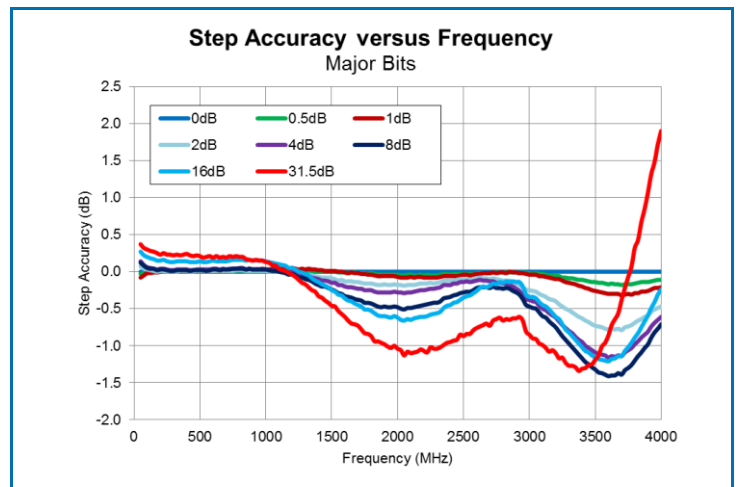
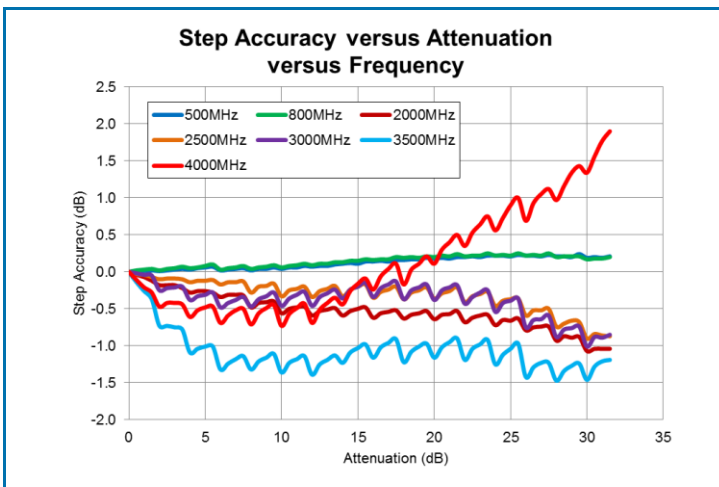
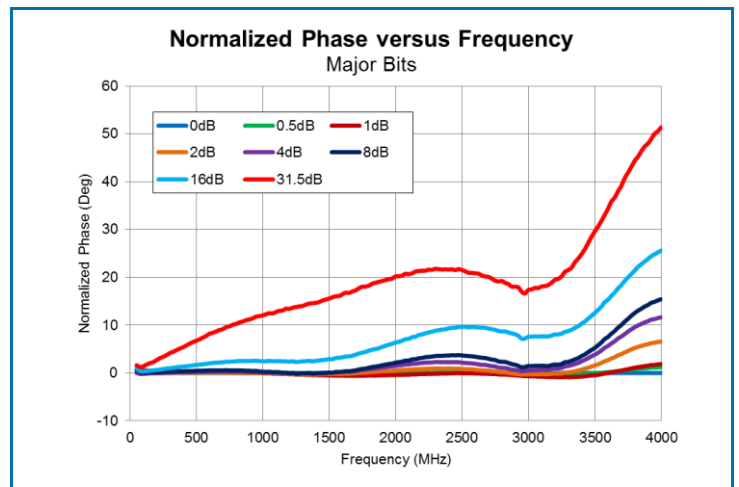
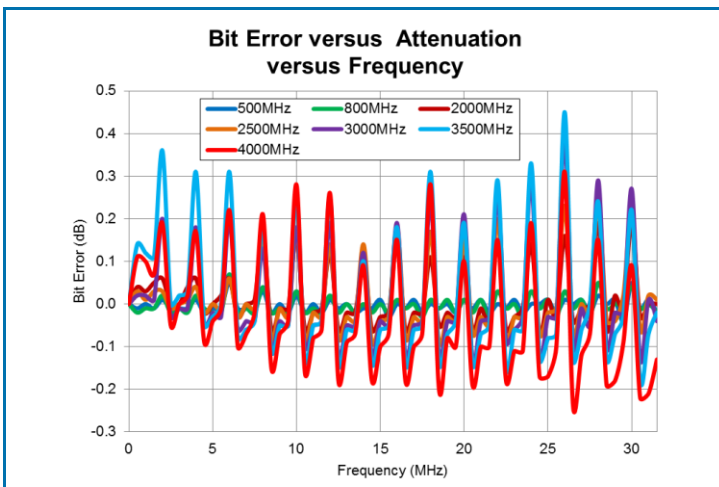
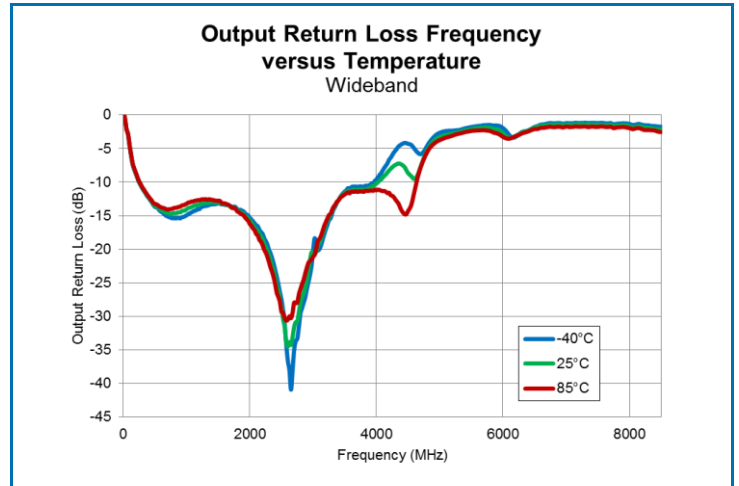
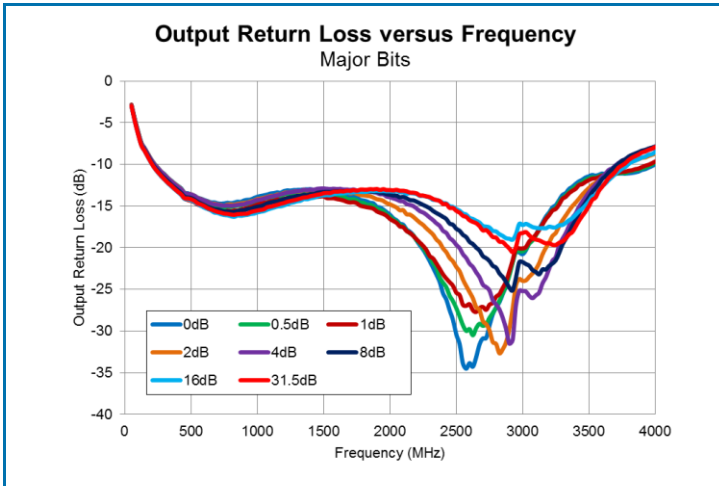

Typical Performance: T = 25°C, V<sub>DD</sub> = 5V unless otherwise noted

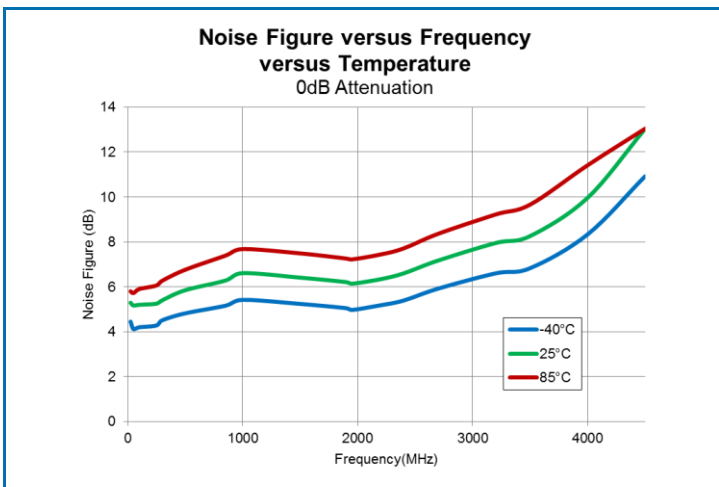
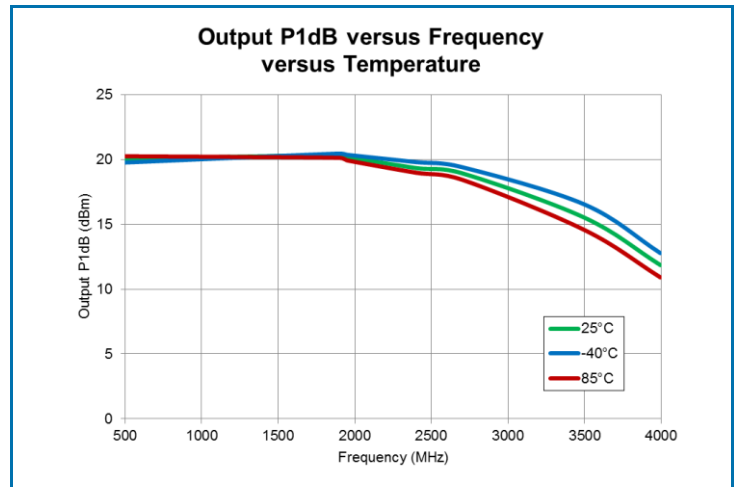
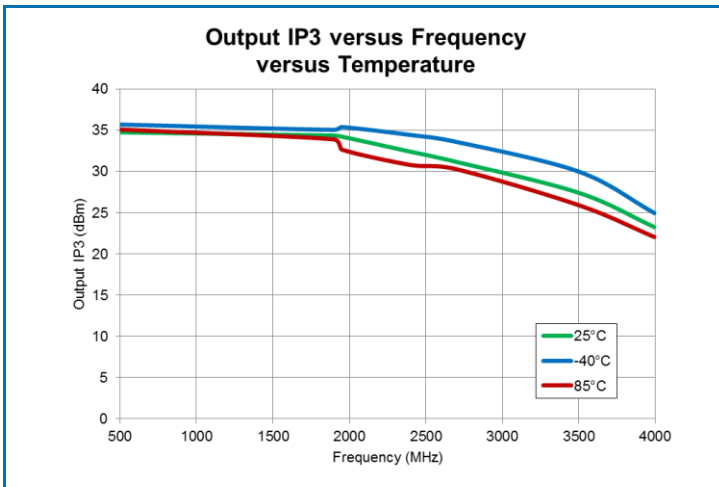
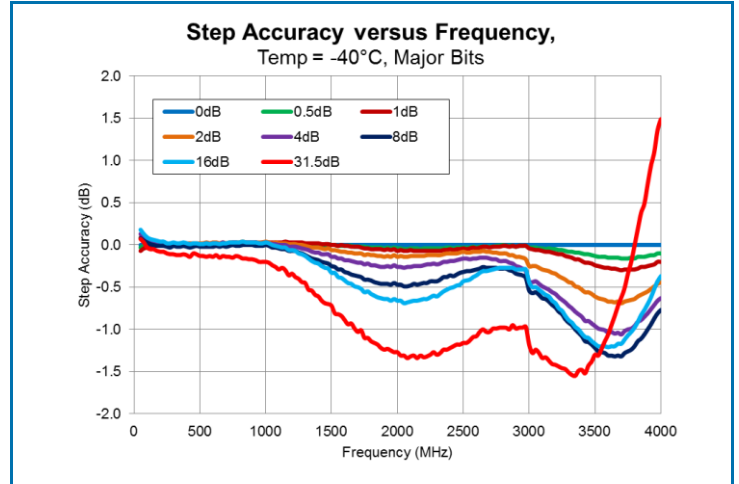
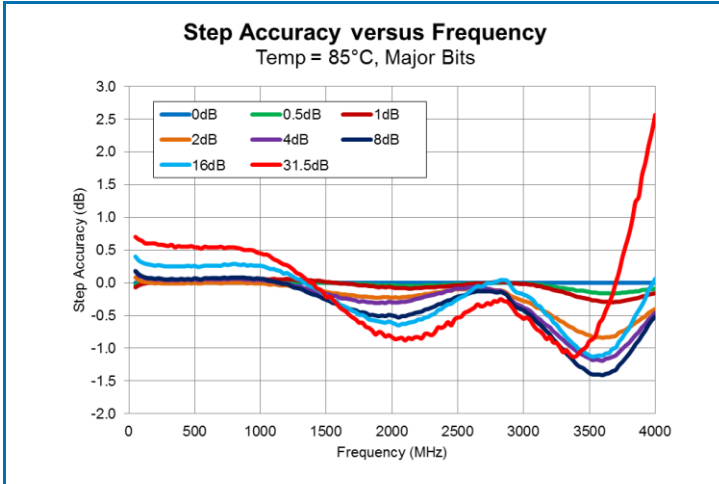

Evaluation Board Schematic 50MHz to 4000MHz Application Circuit

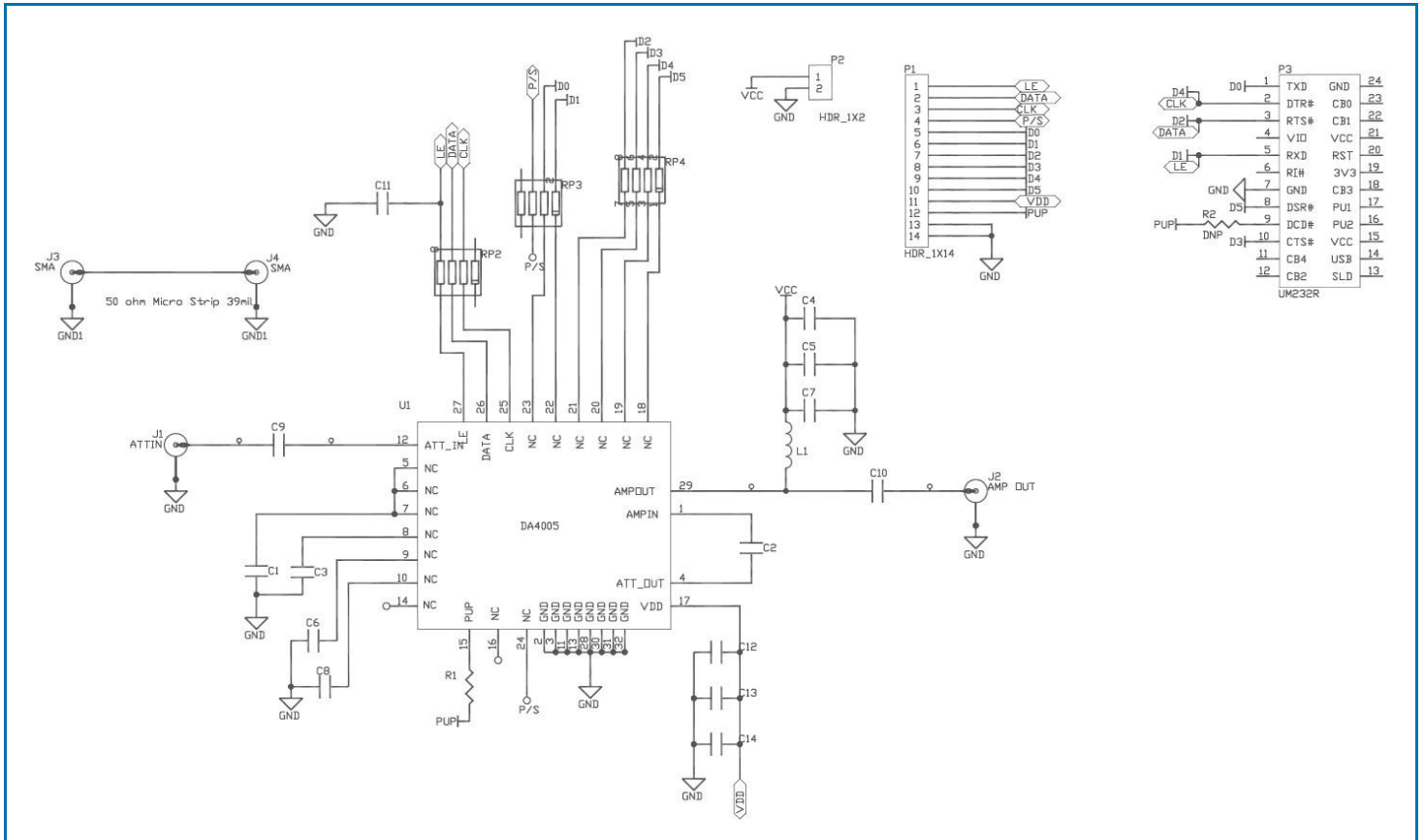



## Evaluation Board Bill of Materials (BOM) 50MHz to 4000MHz Application Circuit

Description	Reference Designator	Manufacturer	Manufacturer's P/N
RDA1005L with USB Evaluation Board	PCB Itself	Dynamic Details (DDI) Toronto	RDA1005L410(C)
50MHz to 4000MHz, G=18dB, P1=19dBm, 6-BIT, DVGA	U1	RFMD	RFDA4005SB
CAP, 1000pF, 10%, 50V, X7R, 0402	C2, C9-C10	Murata Electronics	GRM155R71H102KA01E
CAP, 1µF, 10%, 16V, X7R, 0805	C4, C14	Murata Electronics	GRM21BR71C104KA01K
CAP, 1000pF, 10%, 50V, X7R, 0603	C5, C13	Murata Electronics	GRM188R71H102KA01D
CAP, 100pF, 5%, 50V, C0G, 0402	C1, C3, C6-C8, C12	Murata Electronics	GRM1555C1H101JD01D
IND, 68nH, 5%, W/W, 1008	L1	Coilcraft	1008CS-680XJLC
RES, 1K, 1%, 1/16W, 0402	R1	Panasonic Industrial	ERJ-2RKF1001
RES ARRAY, 4-ELEM, 1K, 5%, SMD 4 x 0402	RP2	KOA	CN1E4KTTD102J
CONN, SMA, END LNCH, FLT, 0.062"	J1-J4	Emerson Network Power	142-0701-821
CONN, HDR, ST, PLRZD, 14-PIN, 0.100"	P1	ITW Pancon	MPSS100-14-C
CONN, HDR, ST, PLRZD, 2-PIN, 0.100"	P2	ITW Pancon	MPSS100-2-C
CONN, SKT, 24-PIN DIP, 0.600", T/H	P3	Aries Electronics Inc.	24-6518-10
MOD, USB TO SERIAL UART, SSOP-28	M1	Future Technology Devices Int'l	UM232R

Evaluation Board Assembly Drawing

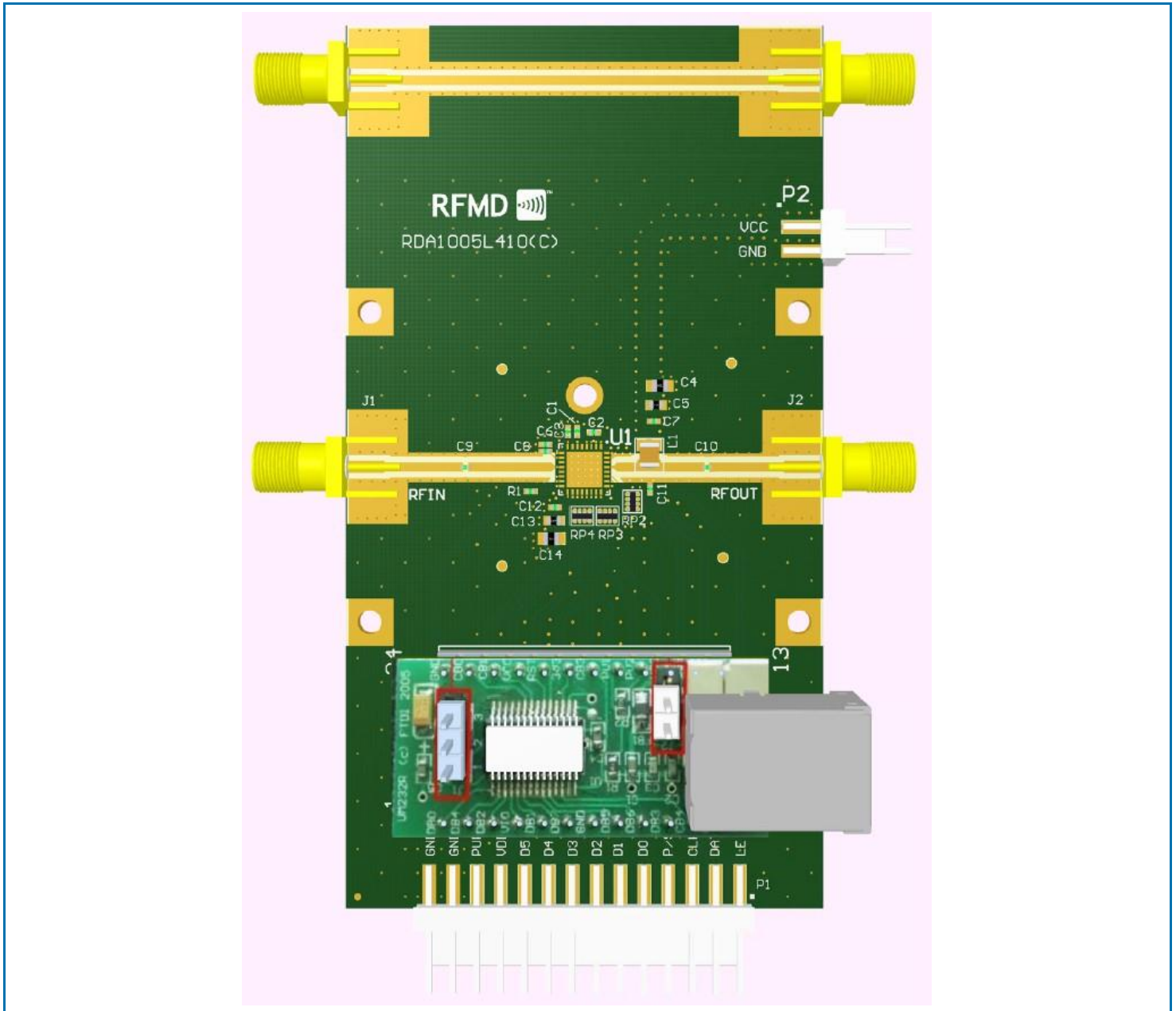

## Serial Attenuation Word Truth Table

Control Bit						Gain Relative to Max Gain
D5	D4	D3	D2	D1	D0	
1	1	1	1	1	1	0dB / Reference Insertion Loss
1	1	1	1	1	0	-0.5dB
1	1	1	1	0	1	-1dB
1	1	1	0	1	1	-2dB
1	1	0	1	1	1	-4dB
1	0	1	1	1	1	-8dB
0	1	1	1	1	1	-16dB
0	0	0	0	0	0	-31,5dB Max Attenuation

## Timing Diagrams

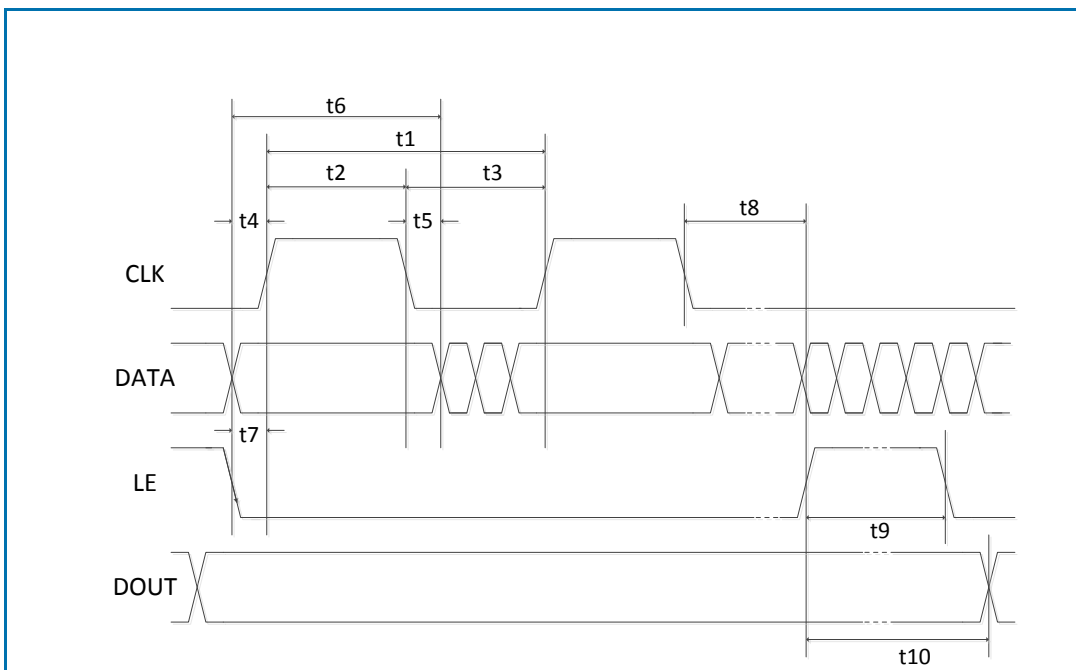

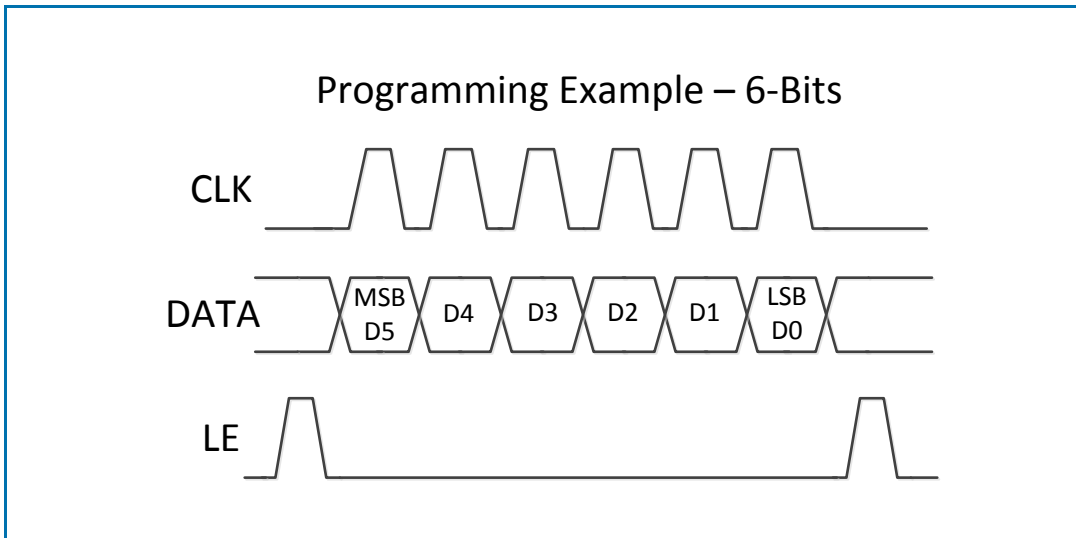

## Timing Specifications

Parameter	Limit	Unit	Comments
t1	25	MHz, max	CLK Frequency
t2	20	ns min	CLK High
t3	20	ns min	CLK Low
t4	5	ns min	DATA to CLK Setup Time
t5	5	ns min	DATA to CLK Hold Time
t6	30	ns min	DATA Valid
t7	5	ns min	LE to CLK Setup Time
t8	5	ns min	CLK to LE Setup Time
t9	10	ns min	LE Pulse Width
t10	20	ns max	Output Set

## Control Voltage

State	Low	High
$V_{DD} = 3V$	0V to 0.8V	2V to $V_{DD}$
$V_{DD} = 5V$	0V to 0.8V	2V to $V_{DD}$

## Power-up Programming Truth Table

PUP	Attenuator Setting
Low	Attenuator at Max, 31.5dB
High	Attenuator at Min, 0dB

## Pin Names and Descriptions

Pin	Name	Description
1	AMPIN	RF Amplifier Input
2	GND	RF/DC Ground Connection
3	GND	RF/DC Ground Connection
4	ATTOUT	Digital Attenuator Output
5	NC	NC Connection; leave open or ground
6	NC	NC Connection; leave open or ground
7	NC	NC Connection; leave open or ground
8	NC	NC Connection; leave open or ground
9	NC	NC Connection; leave open or ground
10	NC	NC Connection; leave open or ground
11	GND	RF/DC Ground Connection
12	ATTIN	Digital Attenuation Input
13	GND	RF/DC Ground Connection
14	NC	NC Connection; leave open or ground
15	PUP	Power-up Programming Pin Low = Max attenuation setting at power up, -31.5dB High = Min attenuation setting at power up, 0dB
16	NC	NC Connection; leave open or ground
17	VDD	Supply Voltage
18	NC	NC Connection; leave open or ground
19	NC	NC Connection; leave open or ground
20	NC	NC Connection; leave open or ground
21	NC	NC Connection; leave open or ground
22	NC	NC Connection; leave open or ground
23	NC	NC Connection; leave open or ground
24	NC	NC Connection; leave open or ground
25	CLK	Serial Clock
26	DATA	Serial Data
27	LE	Latch Enable
28	GND	RF/DC Ground Connection
29	AMPOUT	RF Amplifier Output
30	GND	RF/DC Ground Connection
31	GND	RF/DC Ground Connection
32	GND	RF/DC Ground Connection

Package Outline (Dimensions in millimeters)

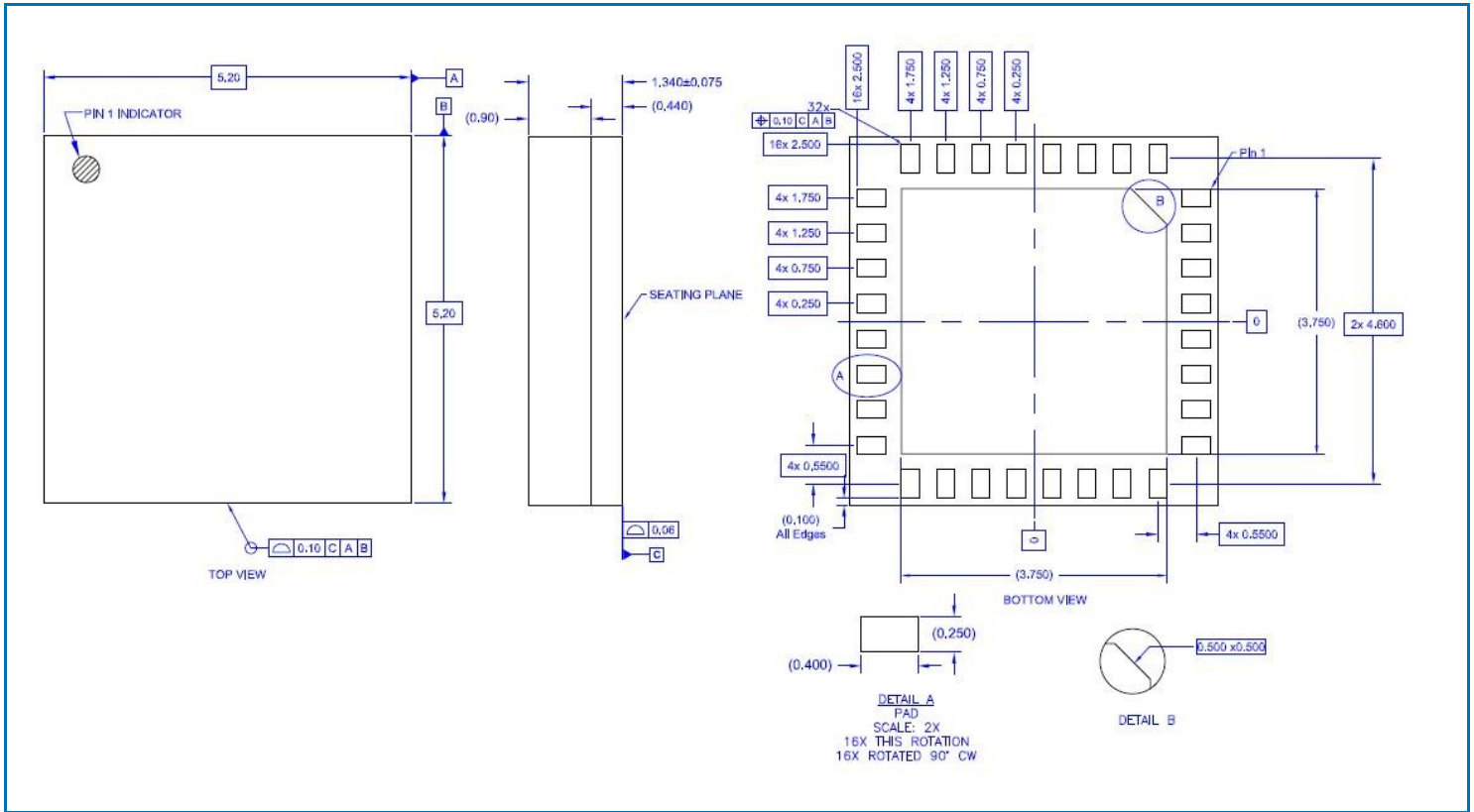

### Stencil Drawing (Dimensions in millimeters)

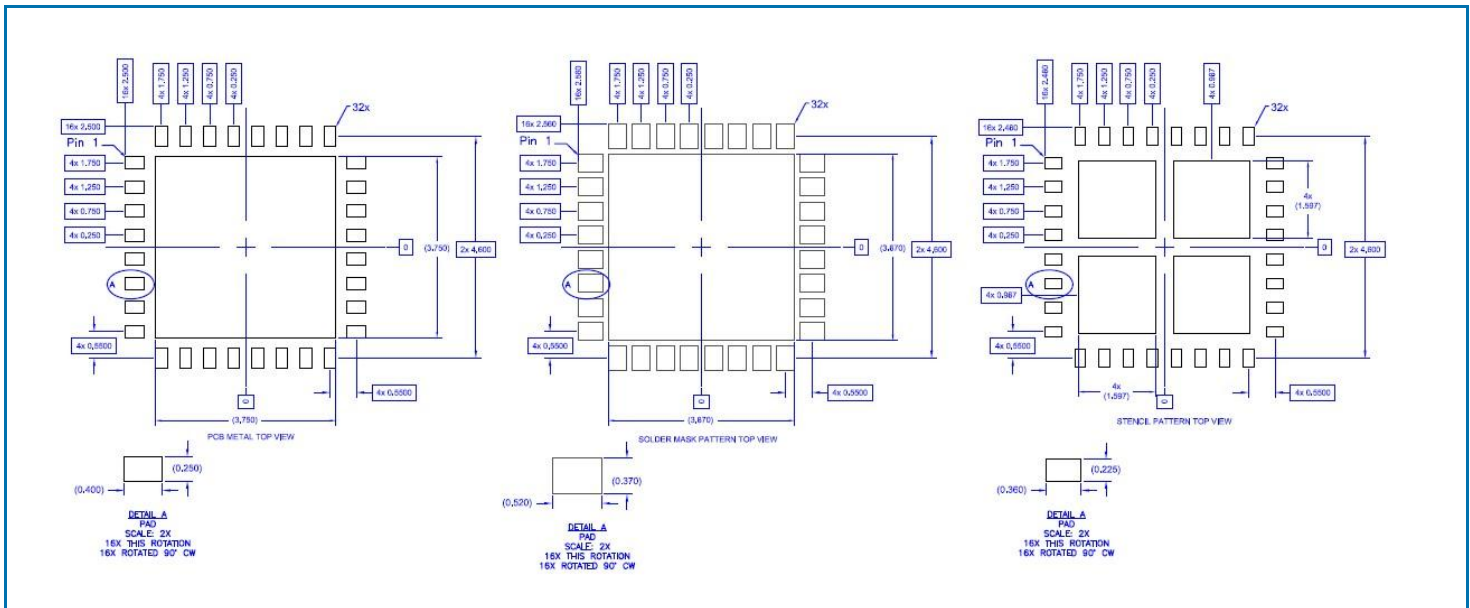

### Branding Diagram

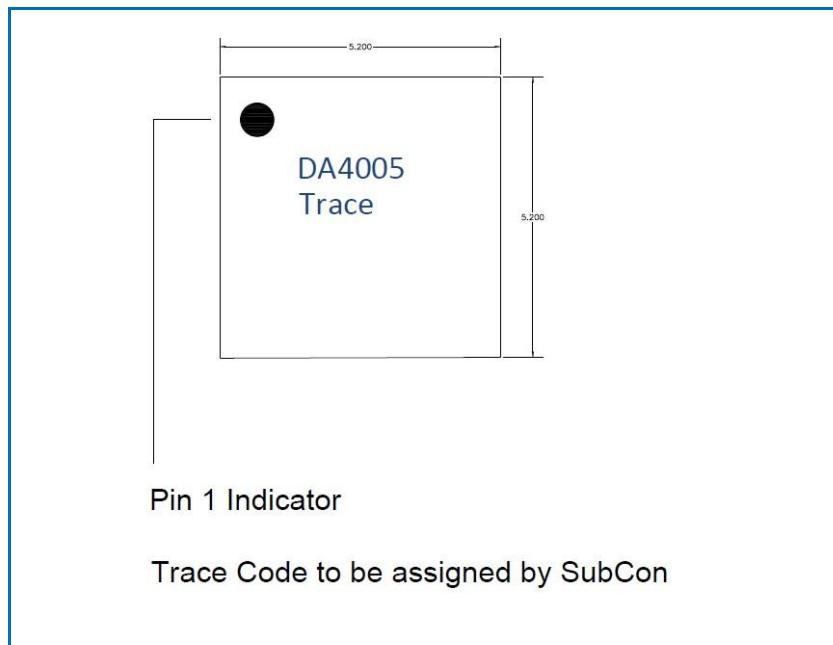



Компания «ЭлектроПласт» предлагает заключение долгосрочных отношений при поставках импортных электронных компонентов на взаимовыгодных условиях!

Наши преимущества:

- Оперативные поставки широкого спектра электронных компонентов отечественного и импортного производства напрямую от производителей и с крупнейших мировых складов;
- Поставка более 17-ти миллионов наименований электронных компонентов;
- Поставка сложных, дефицитных, либо снятых с производства позиций;
- Оперативные сроки поставки под заказ (от 5 рабочих дней);
- Экспресс доставка в любую точку России;
- Техническая поддержка проекта, помощь в подборе аналогов, поставка прототипов;
- Система менеджмента качества сертифицирована по Международному стандарту ISO 9001;
- Лицензия ФСБ на осуществление работ с использованием сведений, составляющих государственную тайну;
- Поставка специализированных компонентов (Xilinx, Altera, Analog Devices, Intersil, Interpoint, Microsemi, Aeroflex, Peregrine, Syfer, Eurofarad, Texas Instrument, Miteq, Cobham, E2V, MA-COM, Hittite, Mini-Circuits, General Dynamics и др.);

Помимо этого, одним из направлений компании «ЭлектроПласт» является направление «Источники питания». Мы предлагаем Вам помощь Конструкторского отдела:

- Подбор оптимального решения, техническое обоснование при выборе компонента;
- Подбор аналогов;
- Консультации по применению компонента;
- Поставка образцов и прототипов;
- Техническая поддержка проекта;
- Защита от снятия компонента с производства.



#### Как с нами связаться

**Телефон:** 8 (812) 309 58 32 (многоканальный)

**Факс:** 8 (812) 320-02-42

**Электронная почта:** [org@eplast1.ru](mailto:org@eplast1.ru)

**Адрес:** 198099, г. Санкт-Петербург, ул. Калинина, дом 2, корпус 4, литера А.