

SB[®] 50 Connectors - up to 120 amps

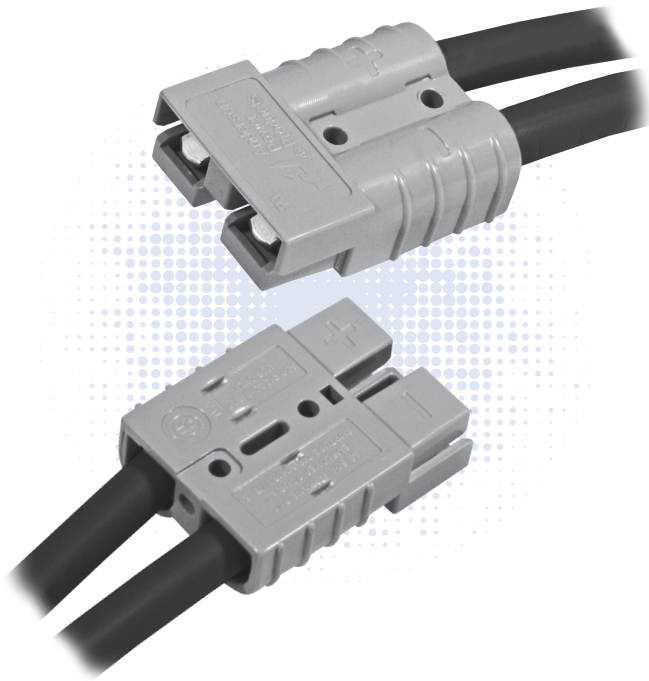

Based off the design pioneered by Anderson in 1953, APP's two pole SB[®] connectors set the standard for DC power distribution and battery connections. SB[®]50 connectors feature a one piece plastic housing using stainless steel springs to hold low resistance contacts in place. Wires sizes from #16 (1.5 mm²) to #6 (13.3 mm²) are held in the smallest of the SB[®] series housings.

- **Low Resistance Silver or Tin Plated Copper Contacts**
Allows UL rated currents up to 120 amps
- **UL Rated for Hot Plugging up to 50 Amps**
Great for battery or other applications where the ability to interrupt circuits is required
- **Wire, PCB, and Busbar Contacts**
Allows one connection system to meet multiple needs

| SB50[®] ORDERING INFORMATION |

SB[®]50 Standard Housings

The smallest SB[®] housings work with wire contacts up to 6 AWG [10 mm²] as well as PCB, and busbar contacts. Genderless design mates with itself. Mechanical keys are color coded.

Description	Voltage	Color	Code	Part Numbers
Minimum Quantity	500	100 ...		
Yellow	12V		992G5-BK	992G5
Orange	18V		992G7-BK	992G7
Red	24V		992G1-BK	992G1
Gray	36V		992-BK	992
Blue	48V		992G4-BK	992G4
Green	72V		992G6-BK	992G6
Black	80V		992G2-BK	992G2

NOTE: SB[®]50 Black and Gray housings have the same keying features and can be intermated.

SB[®]50 Chemical Resistant Housings

Same features as the Standard SB[®]50 but molded in a chemical resistant PBT/ PC blend. Suitable for use to -40°C.

Description	Voltage	Color	Code	Part Numbers
Minimum Quantity	500	100 ...		
Red	24V		P992G1-BK	P992G1
Gray	36V		P992-BK	P992
Black	80V		P992G2-BK	P992G2

NOTE: SB[®]50 Black and Gray housings have the same keying features and can be intermated.

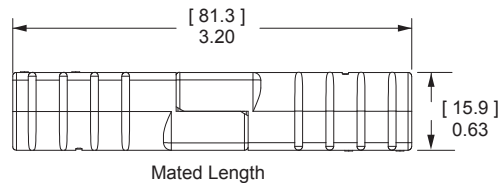
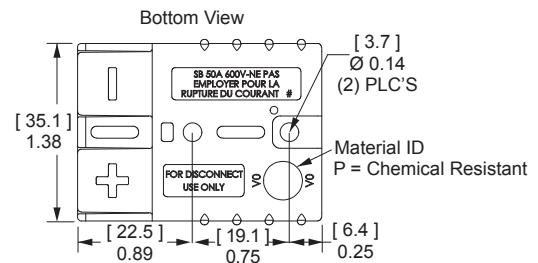

SB®50 Silver Plated Wire Contacts

Use two silver plated contacts per housing for the best electrical performance and durability up to 10,000 mating cycles. See redushing bushings in accessory section for smaller wires.

AWG	mm ²	Mating Force	Loose Piece		Dimensions	
			--- Part Numbers ---		- A -	
					inches	mm
Minimum Quantity			1,000	100		
6	13.3	Low	1307-BK	1307	0.22	5.59
6	13.3	High	5900-BK	5900	0.22	5.59
8	8.4	High	5952-Bk	5952	0.19	4.83
12 to 10	3.3 to 5.3	Low	5953-BK	5953	0.14	3.56
12 to 10	3.3 to 5.3	High	5915-BK	5915	0.14	3.56

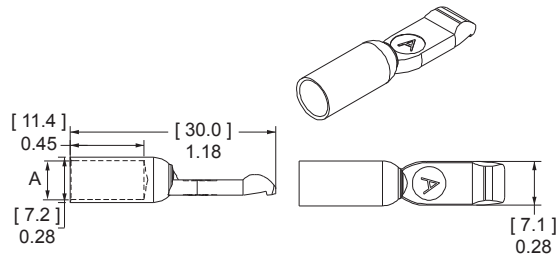

SB®50 Silver Plated Busbar Contacts

Use 2 busbar contacts per housing to provide a quick disconnect input or output busbar connection. Busbar contacts are for mating with wire contacts only. Part number 75BBS includes lock nuts. Locknuts must be ordered separately for B01956P4.

Type	Thread	Mating Force	Loose Piece Part Numbers		
Minimum Quantity			1,000	20	10 ...
Busbar	#10-24	High	B01915P1	-	75BBS
Lock Nut	#10-24	-	H1216P8	110G54	-

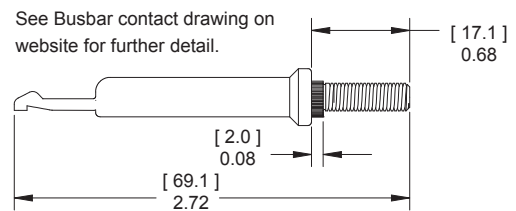

55A Right Angle Standard Powerclaw PCB Contacts

Standard Powerclaw contacts are for use inside a SB®50 housing and provide a color coded right angle connection to the PCB.

Description	- Loose Piece Part Numbers -	
Minimum Quantity	500	100
Tin Plated	PC5930T-BK	PC5930T
Silver Plated	PC5930S-BK	PC5930S

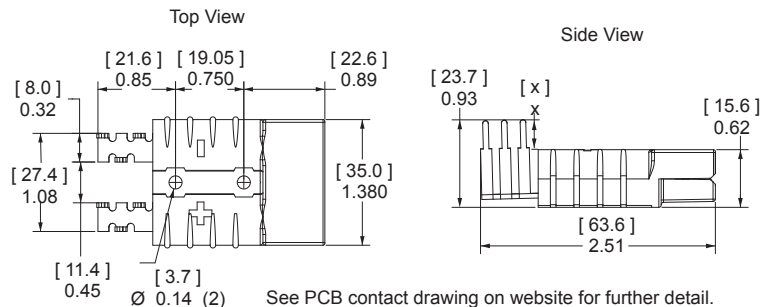

55A Right Angle Mini Powerclaw PCB Contacts

Right angle Mini Powerclaw contacts can be used on the PCB edge without a SB®50 housing on the PCB side. A self polarizing design only allow SB®50 wire housings to mate to PCB contacts one way.

Description	- Loose Piece Part Numbers -	
Minimum Quantity	1,000	100
Tin Plated	PC5934T-BK	PC5934T
Silver Plated	PC5934S-BK	PC5934S

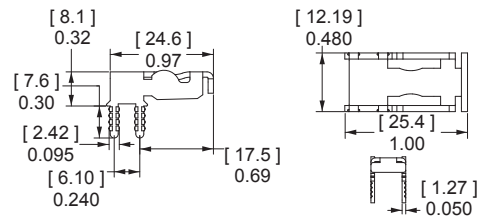

55A Vertical Mini Powerclaw PCB Contacts

Vertical Mini Powerclaw contacts save space by not requiring a SB®50 housing on the PCB side. The guide housing is required for to provide a polarized connection. (See SB®50 accessories).

Description	- Loose Piece Part Numbers -	
Minimum Quantity	1,500	100
Tin Plated	PC5933T-BK	PC5933T
Silver Plated	PC5933S-BK	PC5933S

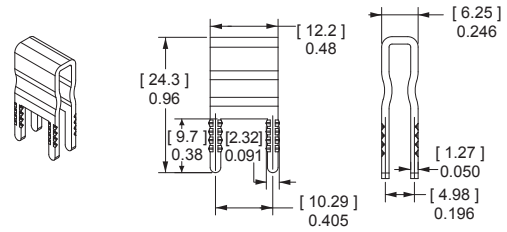

| SB®50 CONNECTOR SPECIFICATIONS |

Electrical		
Current Rating Amperes¹	UL 1977	CSA
Wire to Wire UL 1977 (6 AWG)	120	50
Wire to PCB UL 1977 (6 AWG)	50	
Voltage Rating AC/DC		
UL 1977	600	
PCB Connector Recommended Voltage per IEC 60950-1 Table 2L Pollution Degree²		
Mini Vert. Contact	522	
Mini Horiz. Contact	504	
Standard Contact	950	
Dielectric Withstanding Voltage		
Volts AC	2,200	
Avg. Mated Contact Resistance Milliohms¹		
1 1/4" of #6 AWG wire	0.200	
PCB Contact to Contact	0.500	
UL Hot Plug Current Rating Amperes - 250 cycles at 120V DC		
Wire- wire	50A	
PCB- wire	40A	
(Vertical Mini Powerclaw)		

Materials	
Housing	
Standard Plastic Resin	Polycarbonate
Chem. Resistant Resin	Polycarbonate / PBT blend
Contact Retention Spring	Stainless Steel
Housing Flammability Rating	
UL94	V-0
Contact	
Base	Copper Alloy
Wire Plating	Silver
PCB Plating	Sn or Ag over Ni
Contact Termination Methods	
Crimp ³	Wire Contacts
Hand Solder	Wire and PCB Contacts
Solder Dip*	PCB Contacts
Wave Solder*	PCB Contacts
Wrench / Socket	Busbar Contacts

Mechanical		
Wire Size Range	AWG	mm²
Wire Contacts with Bushings	16 to 6	1.3 to 13.3
Max. Wire Insulation Diameter	in.	mm
	0.440	11.200
Operating Temperature²	°F	°C
Standard	-4° to 221°	-20° to 105°
Chemical Resistant*	-40 to 221°	-40° to 105°
*Chemical resistant material not available for PCB guide housings		
Mating Cycles No Load by Plating	Silver (Ag)	Tin (Sn)
Wire and PCB Contacts	10,000	1,500
Avg. Mating / Unmating Force	Lbf.	N
Wire to Wire Low Force Contacts	10	44
Wire to Wire High Force Contacts	15	67
Standard Powerclaw to Wire	15	66
Mini Powerclaw to Wire	8	36
PCB Specifications		
Mounting Style	Plated Through Hole	
Max PCB Thickness- in. [mm]	Standard: 0.15 [0.381]	
	Mini: 0.25 [0.635]	
Recommended Traces	#8 AWG Cross Section	
Min. Contact / Spring Retention Force	Lbf.	N
Wire Housing	50	222
Min. Creepage / [Clearance] Distance	in.	mm
Standard Powerclaw	0.374	9.5
Mini Vert. Powerclaw	0.213	5.4
Mini Horiz. Powerclaw	0.205	5.2

Protection	
Touch Safety with Wire Contacts	
IEC 60529	IP10

¹ Based on: 105°C rated or better cable of the largest size, Properly calibrated APP® recommended tooling, and a 25°C ambient temperature. UL rating not to exceed the maximum operating temperature. CSA rating below a 30°C temperature rise.

² Limited by the thermal properties of the connector plastic housing.

³ Use APP® recommended tooling only. Alternate tools may adversely affect the performance of our connectors along with UL and CSA recognition.



| SB®50 CONNECTOR TEMPERATURE CHARTS |

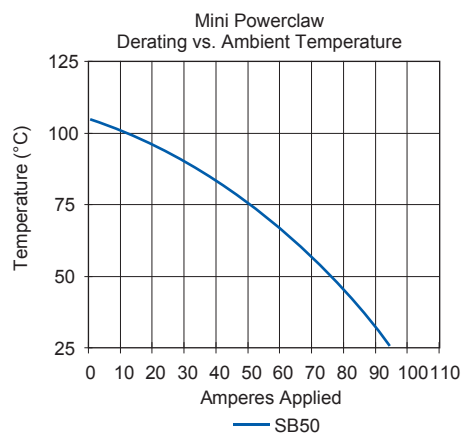
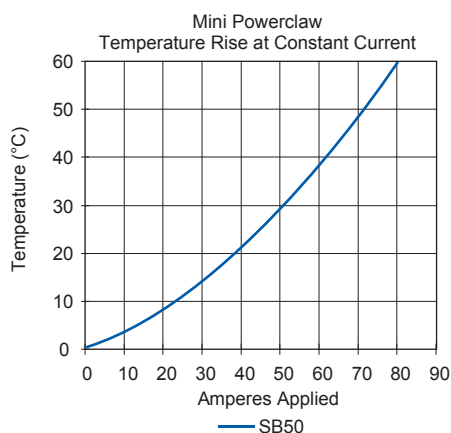
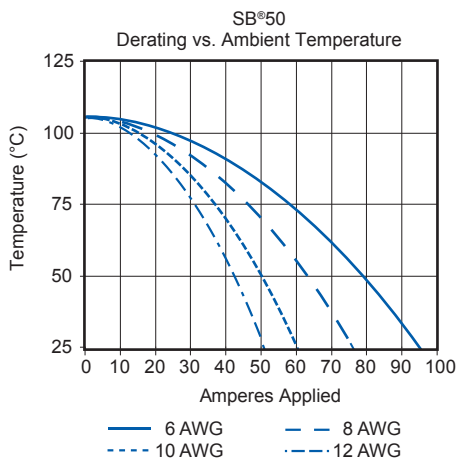
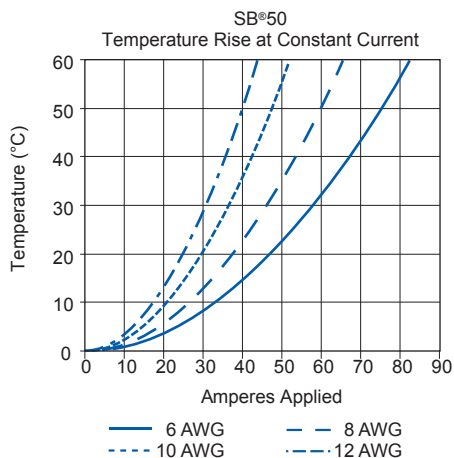

NOTE: Temperature rise charts are based on a 25°C ambient temperature. Powerclaw charts are based on #8 AWG equivalent copper foil on board side, mated to #6 AWG conductor on wire side.

SECTION 3
SB® 50

| SB® Accessories |

“T” Handle

The “T” handle makes mating and unmating the connector easier. The non-conductive red plastic material is strong and safe. (2) Self tapping screws are used to secure the handle to the connector housing.

Description	----- Part Numbers -----	
Minimum Quantity	1,000	50
Red “T” Handle + Hardware Bag	-	SB50-HDL-RED
Hardware Bag (2 Screws)	-	104G17
Red “T” Handle Only	113899P1	-
#8 x 5/8” Screw (Order 2 Per Handle)	H1120P53	-

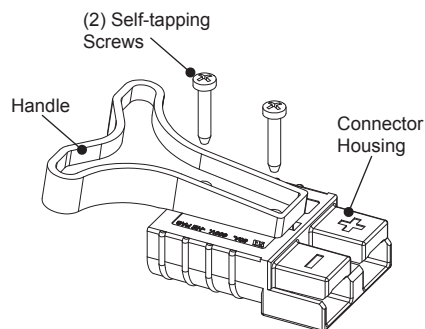

Dust Cover

Prevents dust and dirt from entering the mating interface of the connector when unmated. NOTE: Not a Hermetic Seal.

Description	---- Part Numbers ----	
Minimum Quantity	500	50 ...
Dust Cover with Lanyard Strap, Red	113890P1	134G1

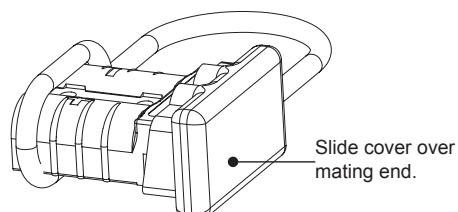

Guide Housings for Vertical Mini Powerclaw Contacts

Prevents polarity being reversed when a SB®50 is mated to vertical mini Powerclaw contacts.

Description	----- Part Numbers -----	
Minimum Quantity	1,000	50
Black Guide Housing	PC-HSG-SB-BK	PC-HSG-SB

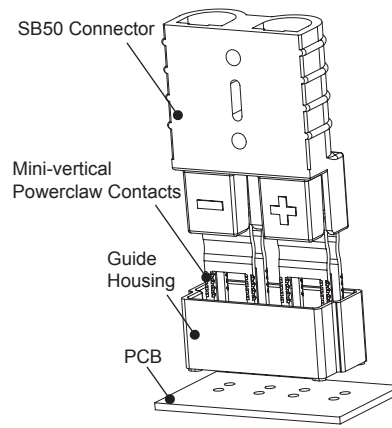

Cable Clamps

Durable metal cable clamps securely hold cables to prevent accidental strain or pulls from dislodging wire or contacts from the housing. Cable clamps are recommended for solder terminated wires.

Description	Cable Size		----- Part Numbers -----	
	AWG or (Inches O.D.)	mm² or (mm O.D.)		
Minimum Quantity			500	50 ...
Self Attaching for Discrete Conductor	8 to 6	10	990-BK	990
Self Attaching for Discrete Conductor	12 to 10	4 to 6	990G2-BK	990G2
Bolt on for Discrete Conductor	12 to 6	4 to 10	990G1-BK	990G1
Bolt on for Bundled Conductor	(0.320 to 0.450)	(4.27 to 11.43)	5905-BK	5905

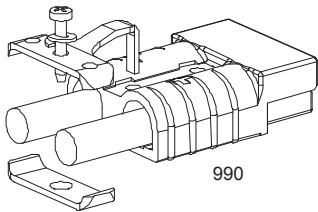

Self attaching discrete conductor.

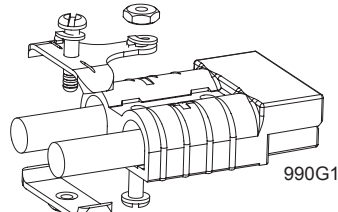

Bolt on discrete conductor.

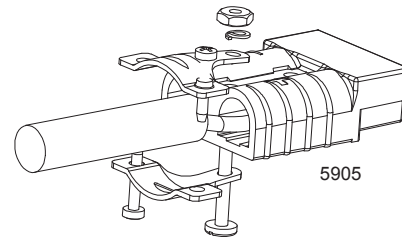

Bolt on bundled conductors.

The given wire O.D. information is an estimate. Cable clamps should be evaluated for performance with the actual wire to be used.

Reducing Bushings

Use with contact part number 5900-BK or 1307-BK to allow a smaller wire to be used with the connector. Electrical capability is derated with smaller wire.

Contact Barrel Size	Wire Size	----- Part Numbers -----			Dimensions			
					- ID -	- Length -		
					inches	mm	inches	mm
Minimum Quantity		3,000	1,000	100				
#6 AWG [13.3 mm²]	#8 AWG [8.4 mm²]	-	5912-BK	5912	0.18	4.57	0.45	11.43
#6 AWG [13.3 mm²]	#12- 10 AWG [3.3- 5.3 mm²]	5910-BK	-	5910	0.14	3.56	0.47	11.94
#6 AWG [13.3 mm²]	#16- 14 AWG [1.3- 2.1 mm²]	5913-BK	-	5913	0.09	2.29	0.47	11.94

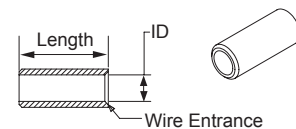

SB®

- Tooling Information

Wire Size		Loose Piece Part Numbers	Loose Piece Contact Crimp Tools				Number of Crimps	Reeled Part Numbers	Reeled Contact Crimp Tools			
AWG	mm²		Hand Tool	or	Pneumatic Bench Tool	+ Die		+ Locator	Tin Plating	ATS Applicator	ATS Press	Air Feed Kit
SB50												
#6	13.3	1307	1309G4	1387G1	1388G6	1389G6	Single	265G5	1385523-1	2-565435-2	692655-1	
		5900										
#8	8.4	5952										
#10 / 12	5.3 / 3.3	5953			1388G7		265G6	1385522-1	1725900-2 or [3-54500-1]	1424266-1 or [354578-1]		
		5915										
SB120												
#1	42.4	1323G1	1368	1387G1	1388G3	1389G4	Single	N/A	N/A			
#2	33.6	1319			1388G4							
#4	21.2	1319G4										
#6	13.3	1319G6										
SB175												
1/0	53.5	1382	1368	1387G2	1303G13	1304G32	Double	N/A	N/A			
#1	42.4	1347			1388G3	1389G3	Single					
#2	33.6	1383			1387G2	1303G13	1304G32					Double
#4	21.1	1384			1387G1	1388G3	1389G3					Single
					1387G2	1303G13	1304G32					Double
#6	13.3	1348			1387G1	1388G4	1389G3					Single
SB350												
300mcm	152	910	1368	1387G2	N/A		Single	N/A	N/A			
4/0	107.2	908			1303G3							
3/0	85	916			1303G12	1304G31	Double					
2/0	67.4	907										
1/0	53.5	917										

NOTE: See website for the most current information.

Mouser Electronics

Authorized Distributor

Click to View Pricing, Inventory, Delivery & Lifecycle Information:

Anderson Power Products:

[134G1](#) [6319](#) [6331G10](#) [6331G2](#) [6331G3](#) [6331G4](#) [6331G5](#) [6331G6](#) [6331G8](#) [6331G9](#) [990G1](#) [990G2](#) [990G2-BK](#)
[992-BK](#) [992G1](#) [992G1-BK](#) [992G2](#) [992G2-BK](#) [992G4](#) [992G4-BK](#) [992G5](#) [992G6](#) [PC-HSG-SB-BK](#) [SB50-HDL-](#)
[RED](#)



Компания «ЭлектроПласт» предлагает заключение долгосрочных отношений при поставках импортных электронных компонентов на взаимовыгодных условиях!

Наши преимущества:

- Оперативные поставки широкого спектра электронных компонентов отечественного и импортного производства напрямую от производителей и с крупнейших мировых складов;
- Поставка более 17-ти миллионов наименований электронных компонентов;
- Поставка сложных, дефицитных, либо снятых с производства позиций;
- Оперативные сроки поставки под заказ (от 5 рабочих дней);
- Экспресс доставка в любую точку России;
- Техническая поддержка проекта, помощь в подборе аналогов, поставка прототипов;
- Система менеджмента качества сертифицирована по Международному стандарту ISO 9001;
- Лицензия ФСБ на осуществление работ с использованием сведений, составляющих государственную тайну;
- Поставка специализированных компонентов (Xilinx, Altera, Analog Devices, Intersil, Interpoint, Microsemi, Aeroflex, Peregrine, Syfer, Eurofarad, Texas Instrument, Miteq, Cobham, E2V, MA-COM, Hittite, Mini-Circuits, General Dynamics и др.);

Помимо этого, одним из направлений компании «ЭлектроПласт» является направление «Источники питания». Мы предлагаем Вам помощь Конструкторского отдела:

- Подбор оптимального решения, техническое обоснование при выборе компонента;
- Подбор аналогов;
- Консультации по применению компонента;
- Поставка образцов и прототипов;
- Техническая поддержка проекта;
- Защита от снятия компонента с производства.



Как с нами связаться

Телефон: 8 (812) 309 58 32 (многоканальный)

Факс: 8 (812) 320-02-42

Электронная почта: org@eplast1.ru

Адрес: 198099, г. Санкт-Петербург, ул. Калинина, дом 2, корпус 4, литера А.