

SB[®] 50 Connectors - up to 120 amps

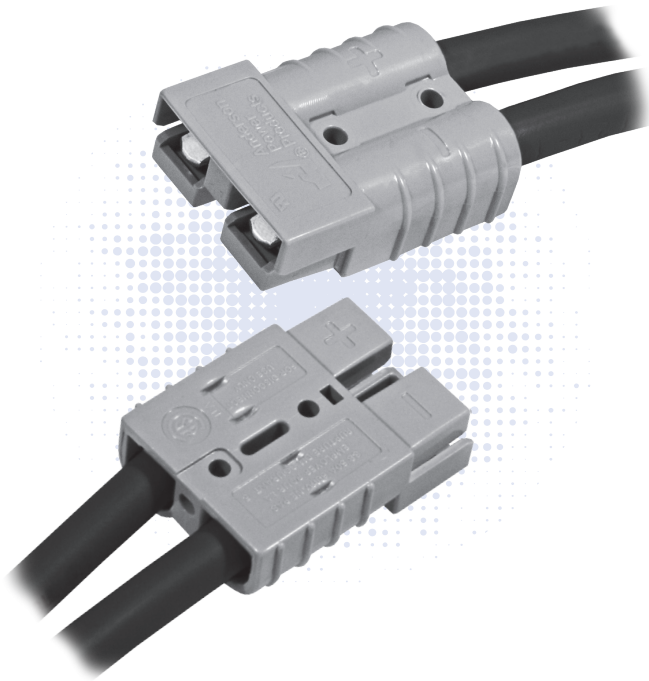

Based off the design pioneered by Anderson in 1953, APP's two pole SB[®] connectors set the standard for DC power distribution and battery connections. SB[®]50 connectors feature a one piece plastic housing using stainless steel springs to hold low resistance contacts in place. Wires sizes from #16 (1.5 mm²) to #6 (13.3 mm²) are held in the smallest of the SB[®] series housings.

- **Low Resistance Silver or Tin Plated Copper Contacts**
Allows UL rated currents up to 120 amps
- **UL Rated for Hot Plugging up to 50 Amps**
Great for battery or other applications where the ability to interrupt circuits is required
- **Wire, PCB, and Busbar Contacts**
Allows one connection system to meet multiple needs

| SB50[®] ORDERING INFORMATION |

SB[®]50 Standard Housings

The smallest SB[®] housings work with wire contacts up to 6 AWG [10 mm²] as well as PCB, and busbar contacts. Genderless design mates with itself. Mechanical keys are color coded.

| Description | Voltage | Color | Code | Part Numbers |
|-----------------------|---------|---------|----------|--------------|
| Minimum Quantity | 500 | 100 ... | | |
| Yellow | 12V | | 992G5-BK | 992G5 |
| Orange | 18V | | 992G7-BK | 992G7 |
| Red | 24V | | 992G1-BK | 992G1 |
| Gray | 36V | | 992-BK | 992 |
| Blue | 48V | | 992G4-BK | 992G4 |
| Green | 72V | | 992G6-BK | 992G6 |
| Black | 80V | | 992G2-BK | 992G2 |

NOTE: SB[®]50 Black and Gray housings have the same keying features and can be intermated.

SB[®]50 Chemical Resistant Housings

Same features as the Standard SB[®]50 but molded in a chemical resistant PBT/ PC blend. Suitable for use to -40°C.

| Description | Voltage | Color | Code | Part Numbers |
|-----------------------|---------|---------|-----------|--------------|
| Minimum Quantity | 500 | 100 ... | | |
| Red | 24V | | P992G1-BK | P992G1 |
| Gray | 36V | | P992-BK | P992 |
| Black | 80V | | P992G2-BK | P992G2 |

NOTE: SB[®]50 Black and Gray housings have the same keying features and can be intermated.



SB®50 Silver Plated Wire Contacts

Use two silver plated contacts per housing for the best electrical performance and durability up to 10,000 mating cycles. See redushing bushings in accessory section for smaller wires.

| AWG | mm ² | Mating Force | Loose Piece | | Dimensions | |
|------------------------|-----------------|--------------|----------------------|------|------------|------|
| | | | --- Part Numbers --- | | - A - | |
| | | | | | inches | mm |
| Minimum Quantity | | | 1,000 | 100 | | |
| 6 | 13.3 | Low | 1307-BK | 1307 | 0.22 | 5.59 |
| 6 | 13.3 | High | 5900-BK | 5900 | 0.22 | 5.59 |
| 8 | 8.4 | High | 5952-Bk | 5952 | 0.19 | 4.83 |
| 12 to 10 | 3.3 to 5.3 | Low | 5953-BK | 5953 | 0.14 | 3.56 |
| 12 to 10 | 3.3 to 5.3 | High | 5915-BK | 5915 | 0.14 | 3.56 |

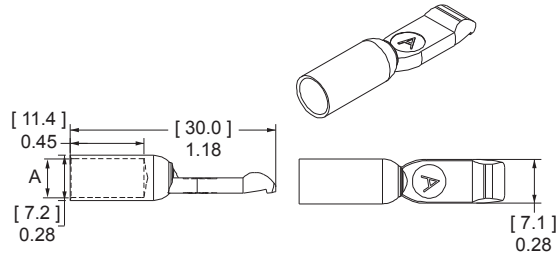

SB®50 Silver Plated Busbar Contacts

Use 2 busbar contacts per housing to provide a quick disconnect input or output busbar connection. Busbar contacts are for mating with wire contacts only. Part number 75BBS includes lock nuts. Locknuts must be ordered separately for B01956P4.

| Type | Thread | Mating Force | Loose Piece Part Numbers | | |
|------------------------|--------|--------------|--------------------------|--------|--------|
| | | | | | |
| Minimum Quantity | | | 1,000 | 20 | 10 ... |
| Busbar | #10-24 | High | B01915P1 | - | 75BBS |
| Lock Nut | #10-24 | - | H1216P8 | 110G54 | - |

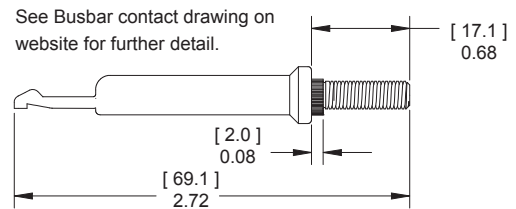

55A Right Angle Standard Powerclaw PCB Contacts

Standard Powerclaw contacts are for use inside a SB®50 housing and provide a color coded right angle connection to the PCB.

| Description | - Loose Piece Part Numbers - | |
|-----------------------|------------------------------|-----------|
| Minimum Quantity | 500 | 100 |
| Tin Plated | PC5930T-BK | PC5930T |
| Silver Plated | PC5930S-BK | PC5930S |



55A Right Angle Mini Powerclaw PCB Contacts

Right angle Mini Powerclaw contacts can be used on the PCB edge without a SB®50 housing on the PCB side. A self polarizing design only allow SB®50 wire housings to mate to PCB contacts one way.

| Description | - Loose Piece Part Numbers - | |
|-----------------------|------------------------------|-----------|
| Minimum Quantity | 1,000 | 100 |
| Tin Plated | PC5934T-BK | PC5934T |
| Silver Plated | PC5934S-BK | PC5934S |

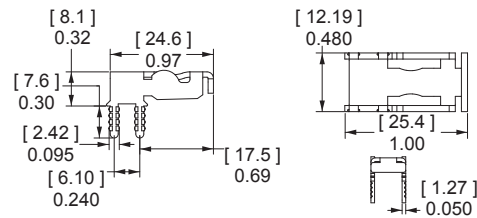

55A Vertical Mini Powerclaw PCB Contacts

Vertical Mini Powerclaw contacts save space by not requiring a SB®50 housing on the PCB side. The guide housing is required for to provide a polarized connection. (See SB®50 accessories).

| Description | - Loose Piece Part Numbers - | |
|-----------------------|------------------------------|-----------|
| Minimum Quantity | 1,500 | 100 |
| Tin Plated | PC5933T-BK | PC5933T |
| Silver Plated | PC5933S-BK | PC5933S |

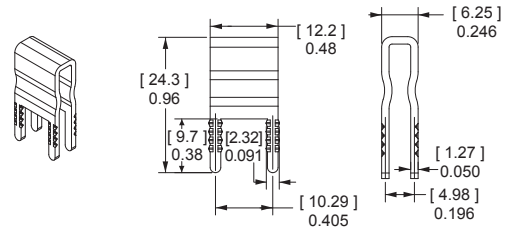

| SB®50 CONNECTOR SPECIFICATIONS |

| Electrical | | |
|--|----------------|------------|
| Current Rating Amperes¹ | UL 1977 | CSA |
| Wire to Wire UL 1977 (6 AWG) | 120 | 50 |
| Wire to PCB UL 1977 (6 AWG) | 50 | |
| Voltage Rating AC/DC | | |
| UL 1977 | 600 | |
| PCB Connector Recommended Voltage per IEC 60950-1 Table 2L Pollution Degree² | | |
| Mini Vert. Contact | 522 | |
| Mini Horiz. Contact | 504 | |
| Standard Contact | 950 | |
| Dielectric Withstanding Voltage | | |
| Volts AC | 2,200 | |
| Avg. Mated Contact Resistance Milliohms¹ | | |
| 1 1/4" of #6 AWG wire | 0.200 | |
| PCB Contact to Contact | 0.500 | |
| UL Hot Plug Current Rating Amperes - 250 cycles at 120V DC | | |
| Wire- wire | 50A | |
| PCB- wire | 40A | |
| (Vertical Mini Powerclaw) | | |

| Materials | |
|------------------------------------|---------------------------|
| Housing | |
| Standard Plastic Resin | Polycarbonate |
| Chem. Resistant Resin | Polycarbonate / PBT blend |
| Contact Retention Spring | Stainless Steel |
| Housing Flammability Rating | |
| UL94 | V-0 |
| Contact | |
| Base | Copper Alloy |
| Wire Plating | Silver |
| PCB Plating | Sn or Ag over Ni |
| Contact Termination Methods | |
| Crimp ³ | Wire Contacts |
| Hand Solder | Wire and PCB Contacts |
| Solder Dip* | PCB Contacts |
| Wave Solder* | PCB Contacts |
| Wrench / Socket | Busbar Contacts |

| Mechanical | | |
|---|------------------------|-----------------------|
| Wire Size Range | AWG | mm² |
| Wire Contacts with Bushings | 16 to 6 | 1.3 to 13.3 |
| Max. Wire Insulation Diameter | in. | mm |
| | 0.440 | 11.200 |
| Operating Temperature² | °F | °C |
| Standard | -4° to 221° | -20° to 105° |
| Chemical Resistant* | -40 to 221° | -40° to 105° |
| *Chemical resistant material not available for PCB guide housings | | |
| Mating Cycles No Load by Plating | Silver (Ag) | Tin (Sn) |
| Wire and PCB Contacts | 10,000 | 1,500 |
| Avg. Mating / Unmating Force | Lbf. | N |
| Wire to Wire Low Force Contacts | 10 | 44 |
| Wire to Wire High Force Contacts | 15 | 67 |
| Standard Powerclaw to Wire | 15 | 66 |
| Mini Powerclaw to Wire | 8 | 36 |
| PCB Specifications | | |
| Mounting Style | Plated Through Hole | |
| Max PCB Thickness- in. [mm] | Standard: 0.15 [0.381] | |
| | Mini: 0.25 [0.635] | |
| Recommended Traces | #8 AWG Cross Section | |
| Min. Contact / Spring Retention Force | Lbf. | N |
| Wire Housing | 50 | 222 |
| Min. Creepage / [Clearance] Distance | in. | mm |
| Standard Powerclaw | 0.374 | 9.5 |
| Mini Vert. Powerclaw | 0.213 | 5.4 |
| Mini Horiz. Powerclaw | 0.205 | 5.2 |

| Protection | |
|--|------|
| Touch Safety with Wire Contacts | |
| IEC 60529 | IP10 |

¹ Based on: 105°C rated or better cable of the largest size, Properly calibrated APP® recommended tooling, and a 25°C ambient temperature. UL rating not to exceed the maximum operating temperature. CSA rating below a 30°C temperature rise.

² Limited by the thermal properties of the connector plastic housing.

³ Use APP® recommended tooling only. Alternate tools may adversely affect the performance of our connectors along with UL and CSA recognition.



| SB®50 CONNECTOR TEMPERATURE CHARTS |

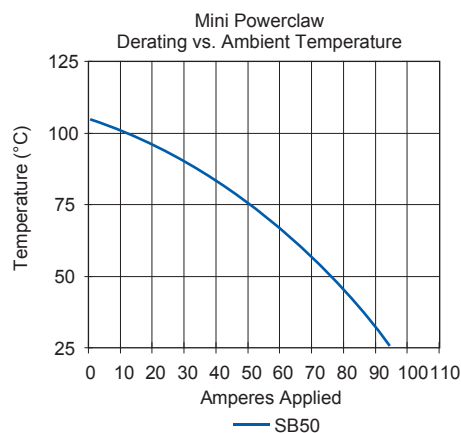
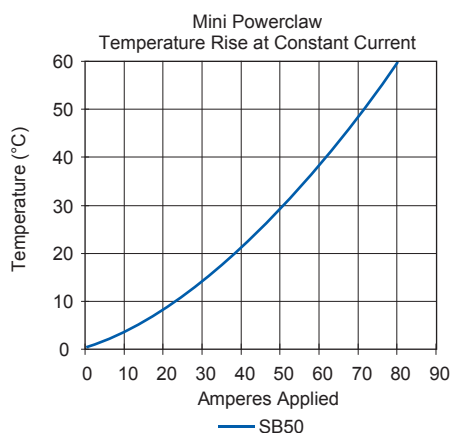
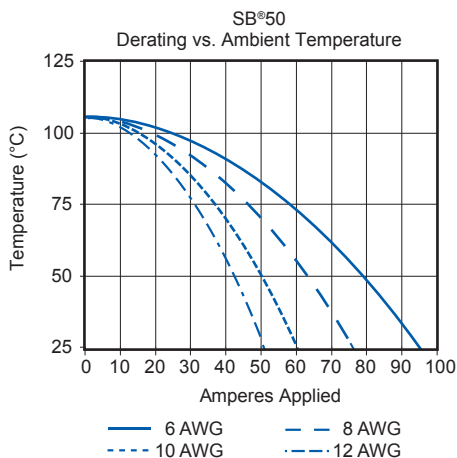
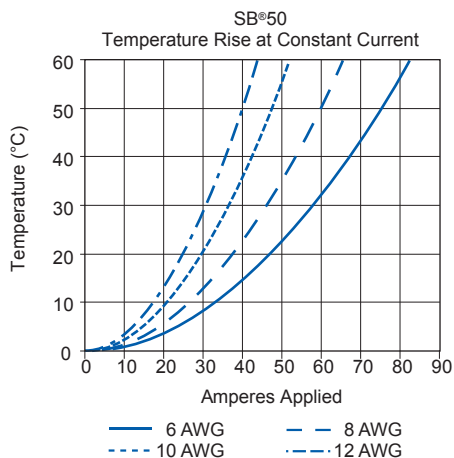

NOTE: Temperature rise charts are based on a 25°C ambient temperature. Powerclaw charts are based on #8 AWG equivalent copper foil on board side, mated to #6 AWG conductor on wire side.

SECTION 3
SB® 50

| SB® Accessories |

“T” Handle

The “T” handle makes mating and unmating the connector easier. The non-conductive red plastic material is strong and safe. (2) Self tapping screws are used to secure the handle to the connector housing.

| Description | ----- Part Numbers ----- | |
|--------------------------------------|--------------------------|--------------|
| Minimum Quantity | 1,000 | 50 |
| Red “T” Handle + Hardware Bag | - | SB50-HDL-RED |
| Hardware Bag (2 Screws) | - | 104G17 |
| Red “T” Handle Only | 113899P1 | - |
| #8 x 5/8” Screw (Order 2 Per Handle) | H1120P53 | - |

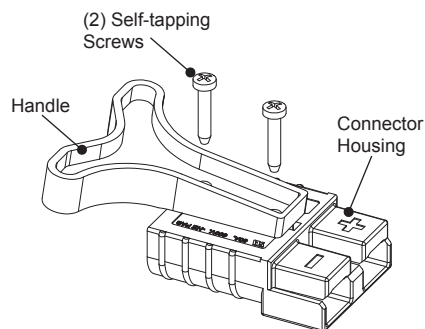

Dust Cover

Prevents dust and dirt from entering the mating interface of the connector when unmated. NOTE: Not a Hermetic Seal.

| Description | ---- Part Numbers ---- | |
|------------------------------------|------------------------|--------|
| Minimum Quantity | 500 | 50 ... |
| Dust Cover with Lanyard Strap, Red | 113890P1 | 134G1 |



Guide Housings for Vertical Mini Powerclaw Contacts

Prevents polarity being reversed when a SB®50 is mated to vertical mini Powerclaw contacts.

| Description | ----- Part Numbers ----- | |
|-----------------------|--------------------------|-----------|
| Minimum Quantity | 1,000 | 50 |
| Black Guide Housing | PC-HSG-SB-BK | PC-HSG-SB |



Cable Clamps

Durable metal cable clamps securely hold cables to prevent accidental strain or pulls from dislodging wire or contacts from the housing. Cable clamps are recommended for solder terminated wires.

| Description | Cable Size | | ----- Part Numbers ----- | |
|---------------------------------------|-------------------------|---------------------------------|--------------------------|--------|
| | AWG or (Inches O.D.) | mm ² or (mm O.D.) | | |
| Minimum Quantity | | | 500 | 50 ... |
| Self Attaching for Discrete Conductor | 8 to 6 | 10 | 990-BK | 990 |
| Self Attaching for Discrete Conductor | 12 to 10 | 4 to 6 | 990G2-BK | 990G2 |
| Bolt on for Discrete Conductor | 12 to 6 | 4 to 10 | 990G1-BK | 990G1 |
| Bolt on for Bundled Conductor | (0.320 to 0.450) | (4.27 to 11.43) | 5905-BK | 5905 |

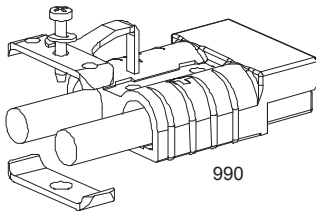

Self attaching discrete conductor.



Bolt on discrete conductor.

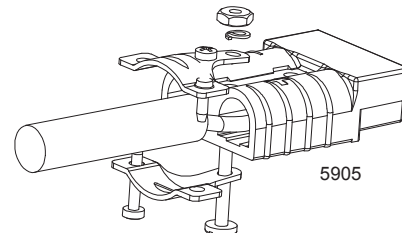

Bolt on bundled conductors.

The given wire O.D. information is an estimate. Cable clamps should be evaluated for performance with the actual wire to be used.

Reducing Bushings

Use with contact part number 5900-BK or 1307-BK to allow a smaller wire to be used with the connector. Electrical capability is derated with smaller wire.

| Contact Barrel Size | Wire Size | ----- Part Numbers ----- | | | Dimensions | | | |
|--------------------------------|---|--------------------------|---------|------|------------|------------|--------|-------|
| | | | | | - ID - | - Length - | | |
| | | | | | inches | mm | inches | mm |
| Minimum Quantity | | 3,000 | 1,000 | 100 | | | | |
| #6 AWG [13.3 mm ²] | #8 AWG [8.4 mm ²] | - | 5912-BK | 5912 | 0.18 | 4.57 | 0.45 | 11.43 |
| #6 AWG [13.3 mm ²] | #12- 10 AWG [3.3- 5.3 mm ²] | 5910-BK | - | 5910 | 0.14 | 3.56 | 0.47 | 11.94 |
| #6 AWG [13.3 mm ²] | #16- 14 AWG [1.3- 2.1 mm ²] | 5913-BK | - | 5913 | 0.09 | 2.29 | 0.47 | 11.94 |



SB®

- Tooling Information

| Wire Size | | Loose Piece Part Numbers | Loose Piece Contact Crimp Tools | | | | Reeled Part Numbers | Reeled Contact Crimp Tools | | | |
|--------------|-----------|--------------------------|---------------------------------|----------------------|---------|-----------|---------------------|----------------------------|----------------|------------|--------------|
| AWG | mm² | | Hand Tool or | Pneumatic Bench Tool | + Die | + Locator | Number of Crimps | Tin Plating | ATS Applicator | ATS Press | Air Feed Kit |
| SB50 | | | | | | | | | | | |
| #6 | 13.3 | 1307 5900 | 1309G4 | 1387G1 | 1388G6 | 1389G6 | Single | 265G5 | 1385523-1 | 2-565435-2 | 692655-1 |
| #8 | 8.4 | 5952 | | | 1388G7 | | | | | | |
| #10 / 12 | 5.3 / 3.3 | 5953 5915 | | | | | | | | | |
| SB120 | | | | | | | | | | | |
| #1 | 42.4 | 1323G1 | 1368 | 1387G1 | 1388G3 | 1389G4 | Single | N/A | N/A | | |
| #2 | 33.6 | 1319 | | | 1388G4 | | | | | | |
| #4 | 21.2 | 1319G4 | | | | | | | | | |
| #6 | 13.3 | 1319G6 | | | | | | | | | |
| SB175 | | | | | | | | | | | |
| 1/0 | 53.5 | 1382 | 1368 | 1387G2 | 1303G13 | 1304G32 | Double | N/A | N/A | | |
| #1 | 42.4 | 1347 | | 1387G1 | 1388G3 | 1389G3 | Single | | | | |
| #2 | 33.6 | 1383 | | 1387G2 | 1303G13 | 1304G32 | Double | | | | |
| #4 | 21.1 | 1384 | | 1387G1 | 1388G3 | 1389G3 | Single | | | | |
| | | | | 1387G2 | 1303G13 | 1304G32 | Double | | | | |
| #6 | 13.3 | 1348 | | 1387G1 | 1388G4 | 1389G3 | Single | | | | |
| SB350 | | | | | | | | | | | |
| 300mcm | 152 | 910 | 1368 | N/A | | | Single | N/A | N/A | | |
| 4/0 | 107.2 | 908 | | 1387G2 | 1303G3 | 1304G31 | Double | | | | |
| 3/0 | 85 | 916 | | | 1303G12 | | | | | | |
| 2/0 | 67.4 | 907 | | | | | | | | | |
| 1/0 | 53.5 | 917 | | | | | | | | | |

NOTE: See website for the most current information.

Mouser Electronics

Authorized Distributor

Click to View Pricing, Inventory, Delivery & Lifecycle Information:

Anderson Power Products:

[134G1](#) [6319](#) [6331G10](#) [6331G2](#) [6331G3](#) [6331G4](#) [6331G5](#) [6331G6](#) [6331G8](#) [6331G9](#) [990G1](#) [990G2](#) [990G2-BK](#)
[992-BK](#) [992G1](#) [992G1-BK](#) [992G2](#) [992G2-BK](#) [992G4](#) [992G4-BK](#) [992G5](#) [992G6](#) [PC-HSG-SB-BK](#) [SB50-HDL-](#)
[RED](#)



Компания «ЭлектроПласт» предлагает заключение долгосрочных отношений при поставках импортных электронных компонентов на взаимовыгодных условиях!

Наши преимущества:

- Оперативные поставки широкого спектра электронных компонентов отечественного и импортного производства напрямую от производителей и с крупнейших мировых складов;
- Поставка более 17-ти миллионов наименований электронных компонентов;
- Поставка сложных, дефицитных, либо снятых с производства позиций;
- Оперативные сроки поставки под заказ (от 5 рабочих дней);
- Экспресс доставка в любую точку России;
- Техническая поддержка проекта, помощь в подборе аналогов, поставка прототипов;
- Система менеджмента качества сертифицирована по Международному стандарту ISO 9001;
- Лицензия ФСБ на осуществление работ с использованием сведений, составляющих государственную тайну;
- Поставка специализированных компонентов (Xilinx, Altera, Analog Devices, Intersil, Interpoint, Microsemi, Aeroflex, Peregrine, Syfer, Eurofarad, Texas Instrument, Miteq, Cobham, E2V, MA-COM, Hittite, Mini-Circuits, General Dynamics и др.);

Помимо этого, одним из направлений компании «ЭлектроПласт» является направление «Источники питания». Мы предлагаем Вам помощь Конструкторского отдела:

- Подбор оптимального решения, техническое обоснование при выборе компонента;
- Подбор аналогов;
- Консультации по применению компонента;
- Поставка образцов и прототипов;
- Техническая поддержка проекта;
- Защита от снятия компонента с производства.



Как с нами связаться

Телефон: 8 (812) 309 58 32 (многоканальный)

Факс: 8 (812) 320-02-42

Электронная почта: org@eplast1.ru

Адрес: 198099, г. Санкт-Петербург, ул. Калинина, дом 2, корпус 4, литера А.