

NCV890203GEVB

NCV890203 Evaluation Board User's Manual



ON Semiconductor®

<http://onsemi.com>

EVAL BOARD USER'S MANUAL

Description

The NCV890203 is a fixed-frequency, monolithic, Buck switching regulator intended for Automotive, battery-connected applications that must operate with up to a 36 V input supply. The regulator is suitable for systems with low noise and small form factor requirements often encountered in automotive driver information systems. The NCV890203 is capable of converting the typical 4.5 V to 18 V automotive input voltage range to outputs as low as 3.3 V at a constant switching frequency above the sensitive AM band, eliminating the need for costly filters and EMI countermeasures. A Reset pin signals when the output is in regulation, and a pin is provided to adjust the delay before the RSTB signal goes high. The NCV890203 also provides several protection features expected in Automotive power supply systems such as current limit, short circuit protection, and thermal shutdown. In addition, the high switching frequency produces low output voltage ripple even when using small inductor values and an all-ceramic output filter capacitor – forming a space-efficient switching regulator solution.

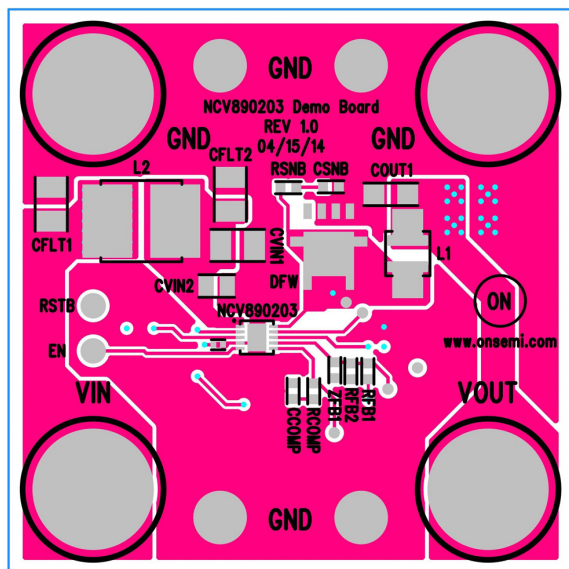

Figure 1. NCV890203 Evaluation Board

Key Features

- Internal N-channel Power Switch
- Low V_{IN} Operation Down to 4.5 V
- High V_{IN} Operation to 36 V
- Withstands Load Dump to 40 V
- 2 MHz Free-running Switching Frequency
- Reset with Adjustable Delay
- Logic level Enable Input Can be Directly Tied to Battery
- 2.0 A (min) Cycle-by-Cycle Peak Current Limit
- Short Circuit Protection enhanced by Frequency Foldback
- $\pm 1.75\%$ Output Voltage Tolerance
- Output Voltage Adjustable Down to 0.8 V
- 1.4 Millisecond Internal Soft-Start
- Thermal Shutdown (TSD)
- Low Shutdown Current
- NCV Prefix for Automotive and Other Applications Requiring Unique Site and Control Change Requirements; AEC-Q100 Qualified and PPAP Capable
- Wettable Flanks DFN (Pin Edge Plating)
- These Devices are Pb-Free and are RoHS Compliant

Typical Applications

- Audio, Infotainment, Safety – Vision Systems, Instrumentation

NCV890203GEVB

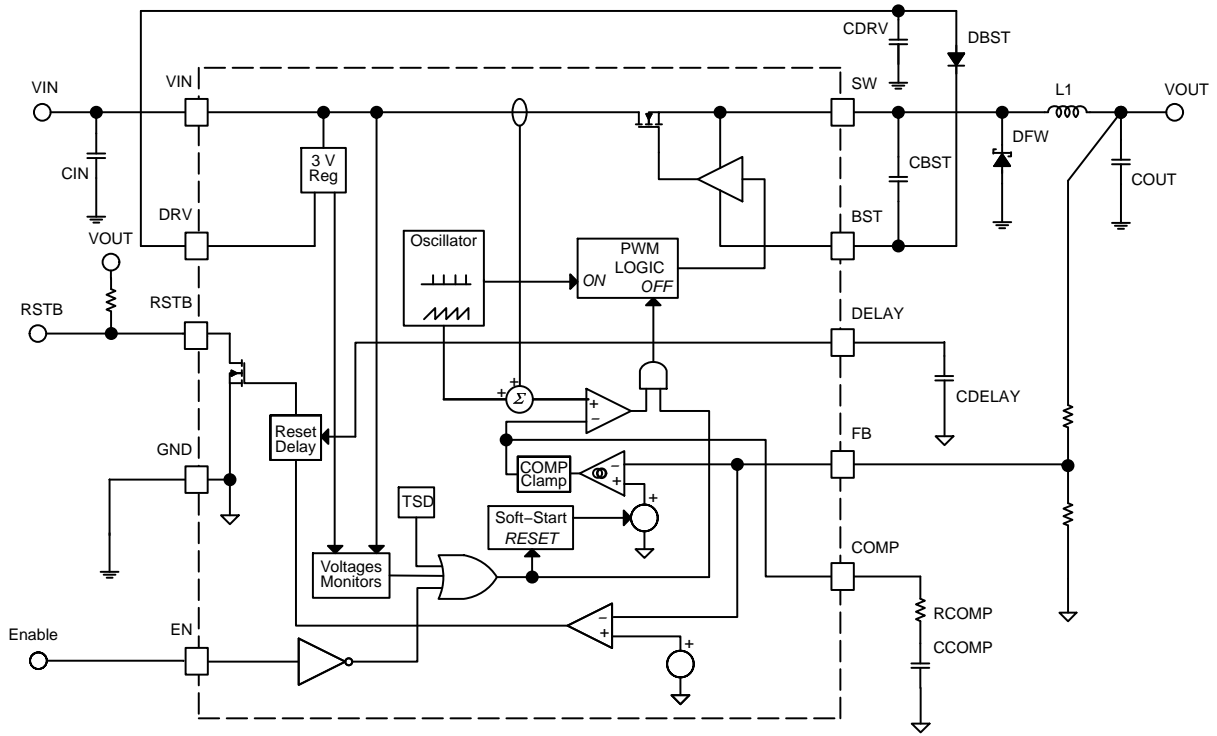

Figure 2. NCV890203 Block Diagram

TYPICAL APPLICATION

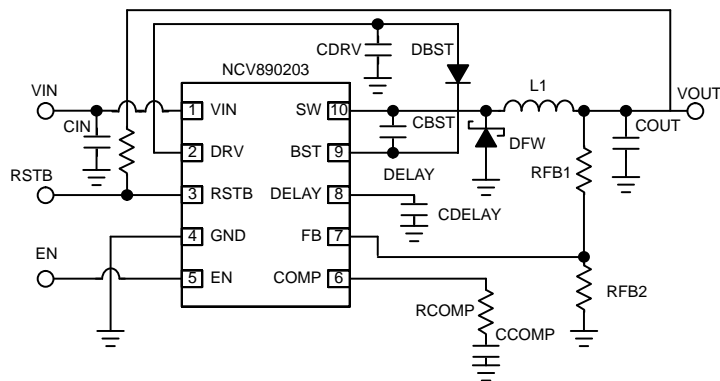

Figure 3. NCV890203 Typical Application

NCV890203GEVB

Table 1. EVALUATION BOARD TERMINALS

Pin Name	Function
VIN	Positive dc Input Voltage
GND	Common dc Return
VOUT	Positive dc Output Voltage
EN	Master Enable Input
RSTB	Reset with Adjustable Delay

Table 2. ABSOLUTE MAXIMUM RATINGS (Voltages are with respect to GND)

Rating	Value	Unit
Dc Supply Voltage (VIN, EN)	-0.3 to 40	V
Dc Supply Voltage (RSTB)	-0.3 to 6	V
Storage Temperature Range	-55 to +150	°C

Stresses exceeding those listed in the Maximum Ratings table may damage the device. If any of these limits are exceeded, device functionality should not be assumed, damage may occur and reliability may be affected.

Table 3. ELECTRICAL CHARACTERISTICS

Characteristic	Conditions	Typical Value	Unit
REGULATION			
Output Voltage (VOUT)		5.0	V
Line Regulation (VOUT)	$I_{OUT} = 1.0 \text{ A}$	0.1	%
Load Regulation (VOUT)	$V_{IN} = 13.2 \text{ V}$	0.1	%
SWITCHING			
Switching Frequency		2.0	MHz
Soft-start Time		1.4	ms
CURRENT LIMIT			
Peak Current Limit (VOUT)	$EN = 5 \text{ V}$	3.25	A
PROTECTIONS			
Input Undervoltage Lockout (UVLO)	V_{IN} Decreasing	3.4	V
Thermal Shutdown	T_J Rising	170	°C

Product parametric performance is indicated in the Electrical Characteristics for the listed test conditions, unless otherwise noted. Product performance may not be indicated by the Electrical Characteristics if operated under different conditions.

NCV890203GEVB

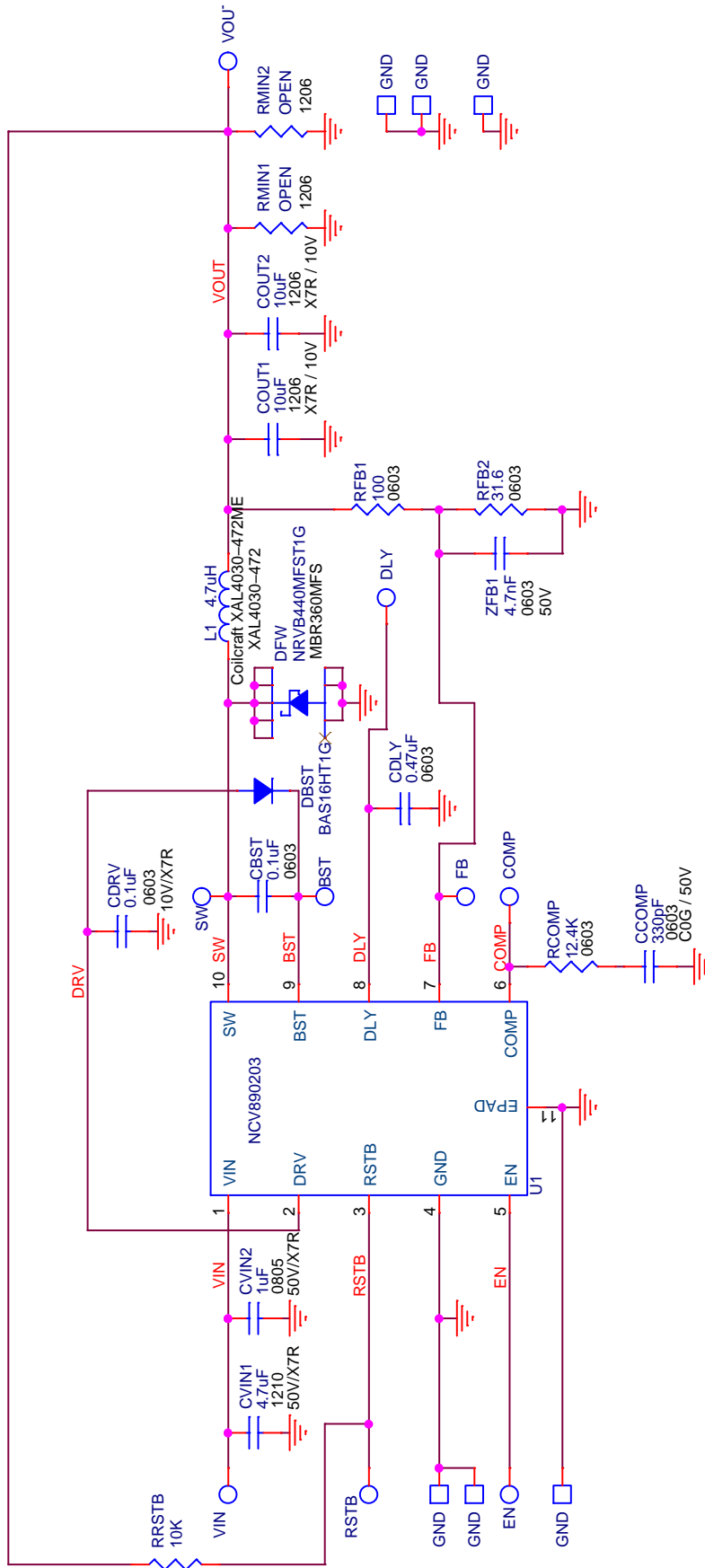

Figure 4. NCV890203GEVB Evaluation Board Schematic

NCV890203GEVB

OPERATIONAL GUIDELINES

1. Connect a dc input voltage, within the 6.0 V to 36 V range, between VIN and GND.
2. Connect a dc enable voltage, within the 2.0 V to 36 V range, between EN and GND. This will power up the switcher. The VOUT signal should be 3.3 V.
3. Add a load to VOUT – up to 2.0 A.

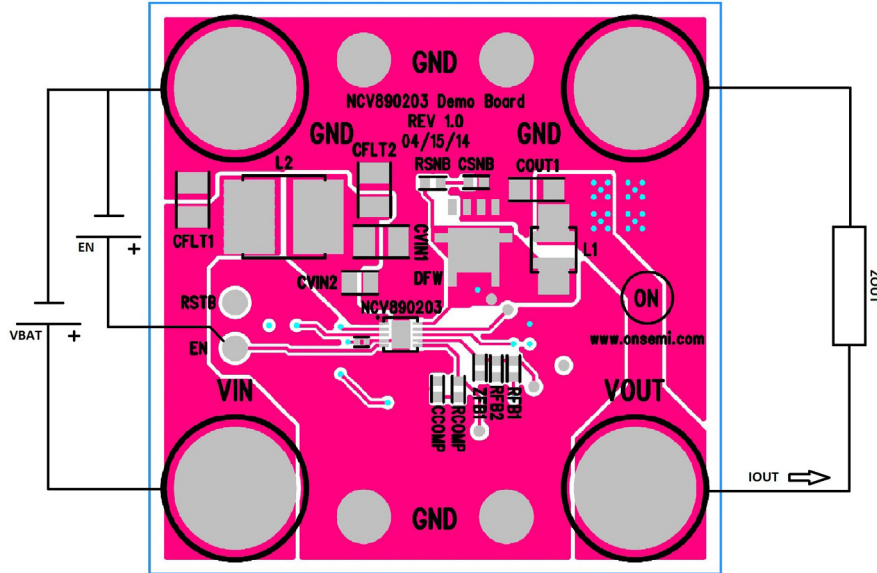
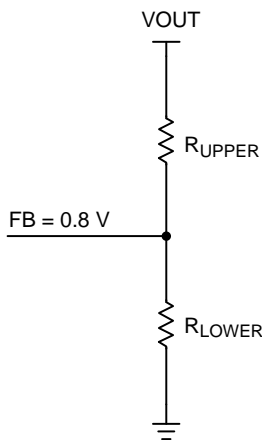

Figure 5. NCV890203 Board Connections

ADDITIONAL GUIDELINES

Output Voltage Selection

The voltage output for the switcher is adjustable and can be set with a resistor divider. The FB reference for the switcher is 0.8 V.



Use the following equation:

$$R_{UPPER} = R_{LOWER} \frac{V_{OUT} - V_{FB}}{V_{FB}}$$

Some common setups are listed below:

Desired Output (V)	VREF (V)	R _{UPPER} (kΩ, 1%)	R _{LOWER} (kΩ, 1%)
1.2	0.8	5.11	10.0
1.5	0.8	8.87	10.0
1.8	0.8	12.7	10.0
2.5	0.8	21.5	10.0
3.3	0.8	31.6	10.0
5.0	0.8	52.3	10.0

Reset with Adjustable Delay

The RSTB pin is pulled low as long as the voltage on the FB pin is lower than 92% (typical) of the reference voltage (which corresponds to the output voltage being lower than 92% of its regulation level). It is high impedance when the voltage goes above 94% (typical) of the regulation level, after a delay adjusted by the capacitor on the DELAY pin.

The capacitor is held at ground until the output enters regulation: C_{DELAY} is then quickly charged to the internal rail voltage (V_{RESU}), then discharged by the I_{delay} current until its voltage reaches the lower threshold V_{DELTH}. Only at this moment the RSTB pin voltage goes high, indicating the end of the Reset condition.

NCV890203GEVB

A small filtering delay (of duration t_{PG}) ensures that the RSTB signal doesn't toggle from high to low in case of high frequency noise when the output is in regulation.

A pull-up resistor is needed on the RSTB pin, as it features an open collector output, capable of sinking 1 mA minimum at 400 mV.

The RSTB pin is also pulled low in case of UVLO (V_{IN} below the UVLO threshold), TSD (temperature shutdown) or Disable (V_{EN} below the enable threshold) events.

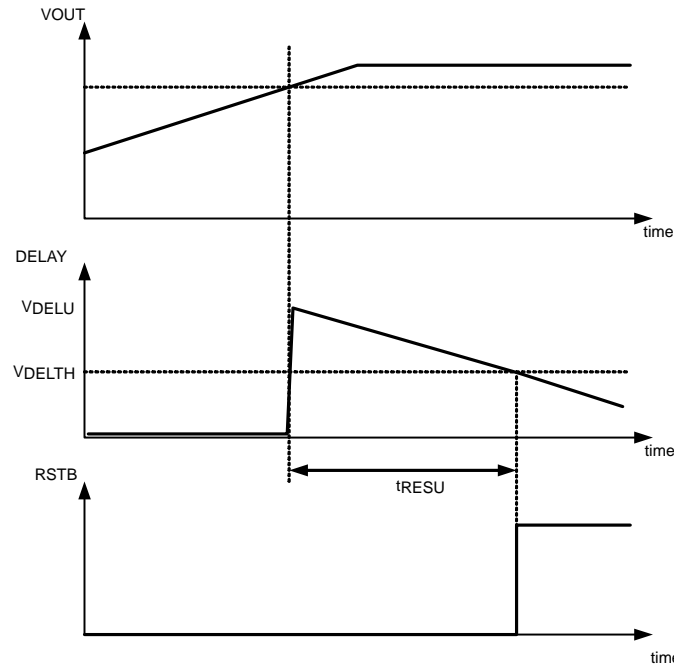

Figure 6. Typical Operation of the Reset with Delay Function

NCV890203GEVB

TYPICAL PERFORMANCE

Efficiency

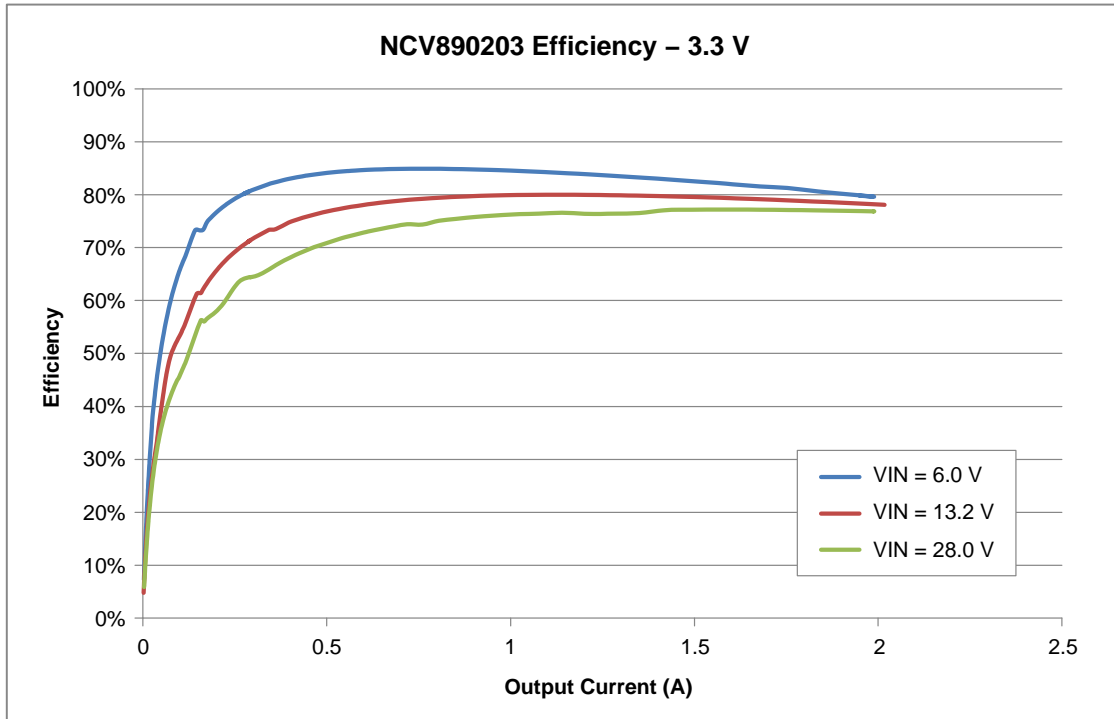

Figure 7. Efficiency with a 3.3 V Output

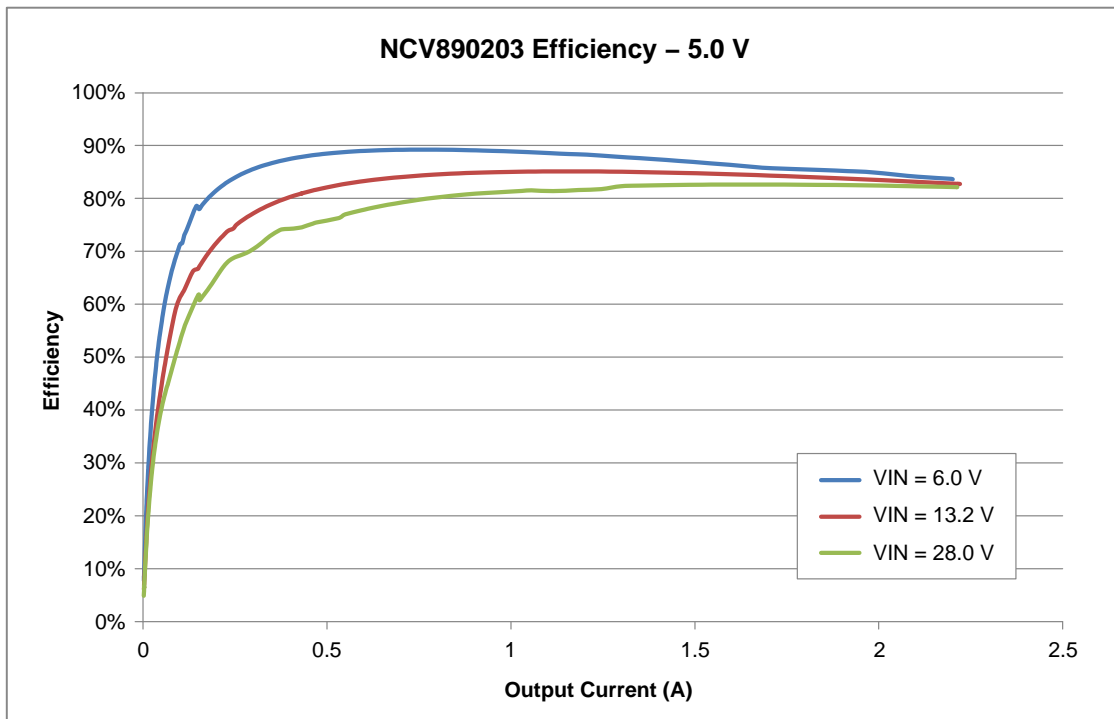

Figure 8. Efficiency with a 5.0 V Output

NCV890203GEVB

Line Regulation

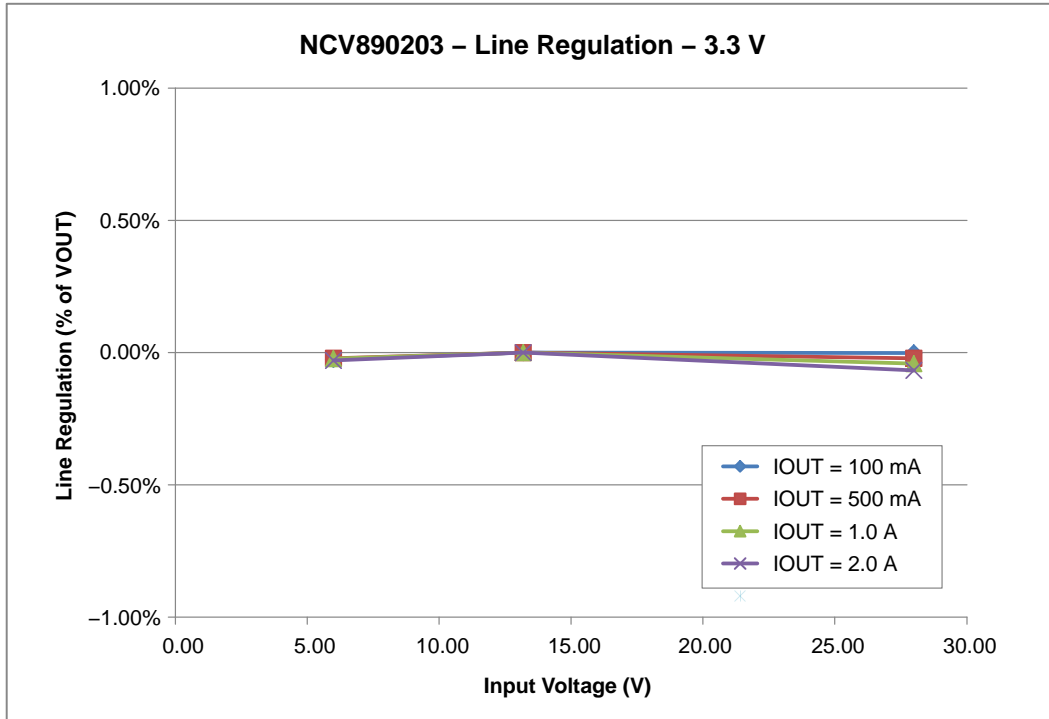

Figure 9. Line Regulation for a 3.3 V Output

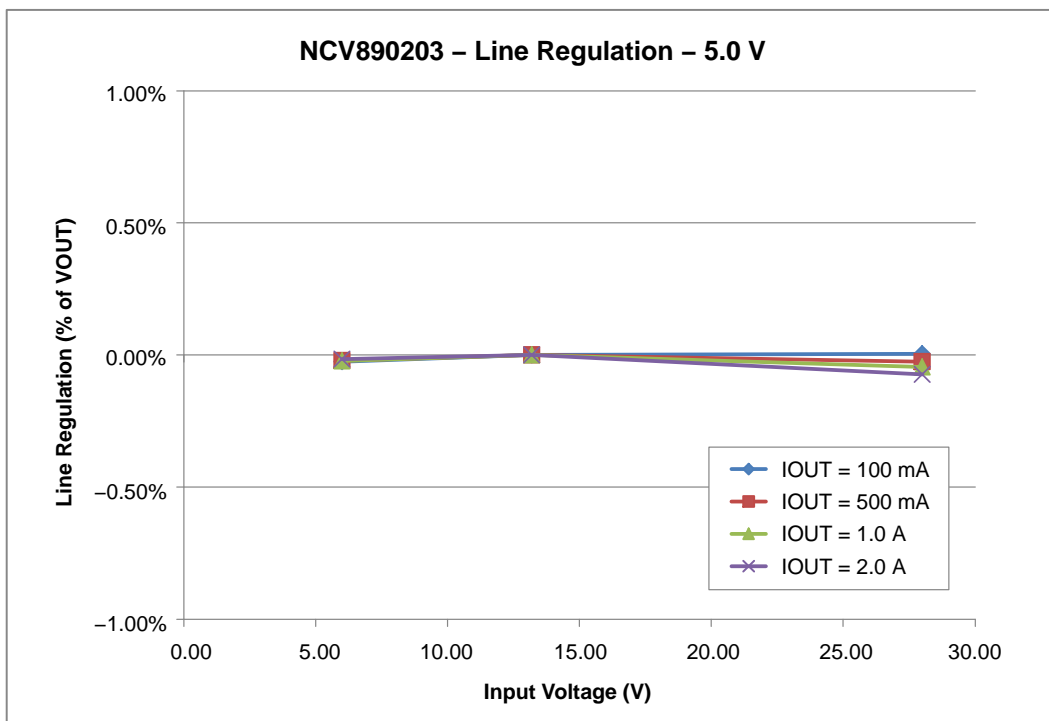

Figure 10. Line Regulation for a 5.0 V Output

NCV890203GEVB

Load Regulation

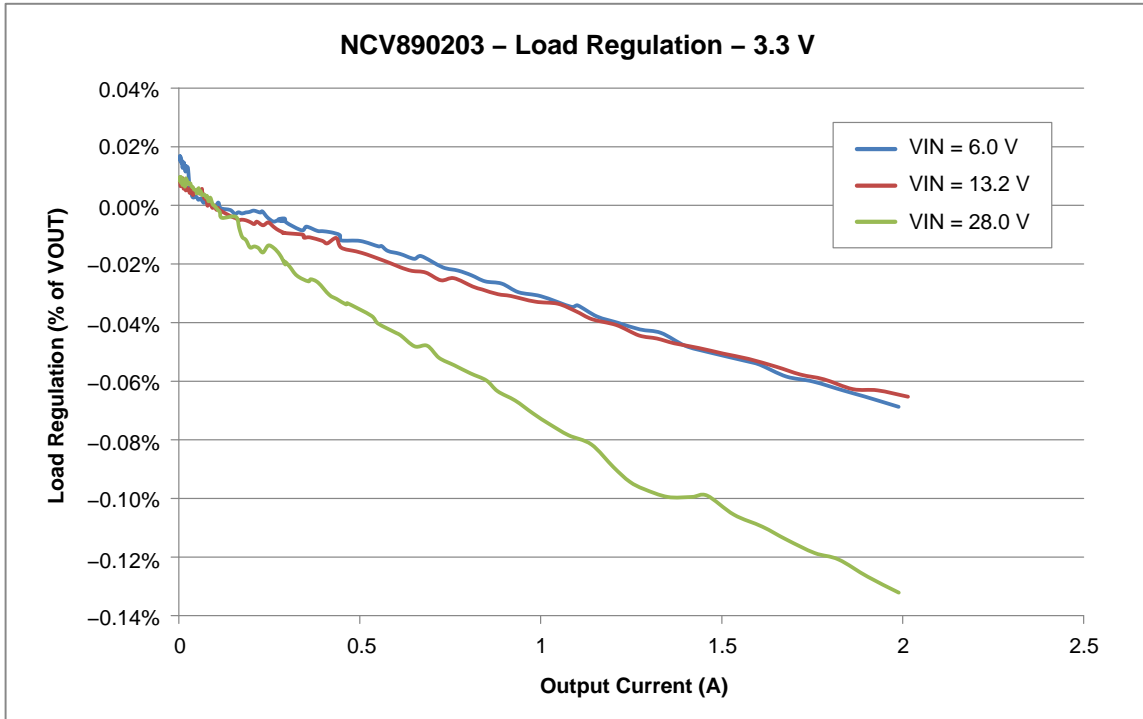

Figure 11. Load Regulation with a 3.3 V Output

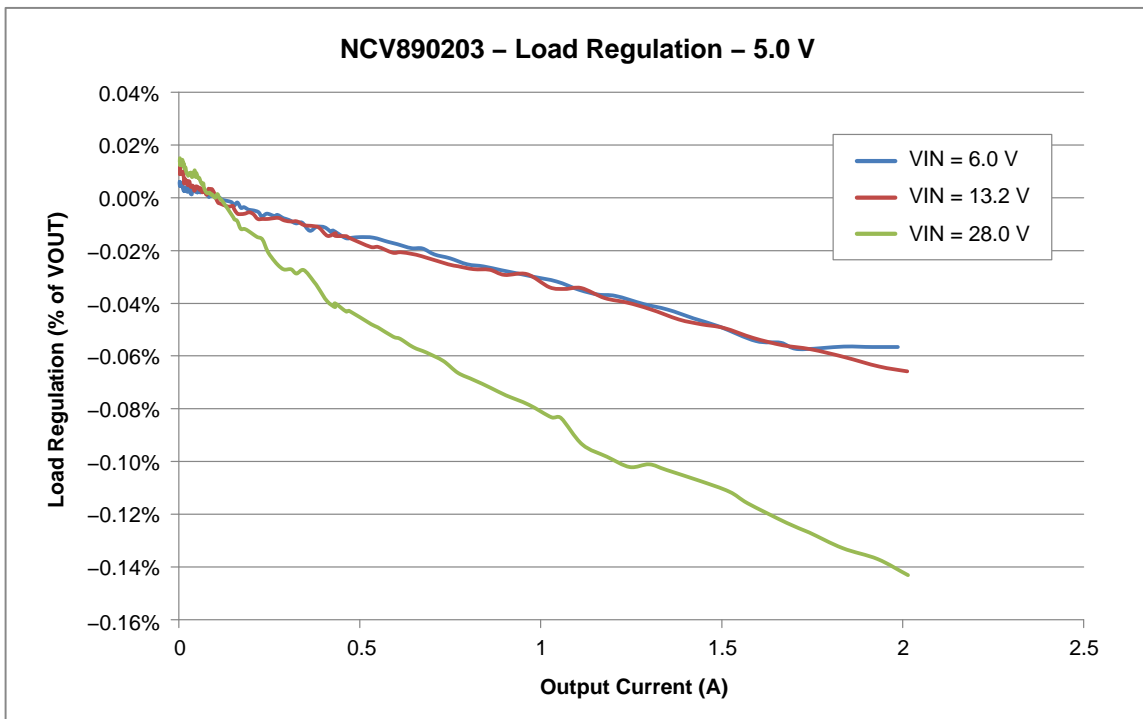

Figure 12. Load Regulation with a 5.0 V Output

NCV890203GEVB

SCHEMATIC

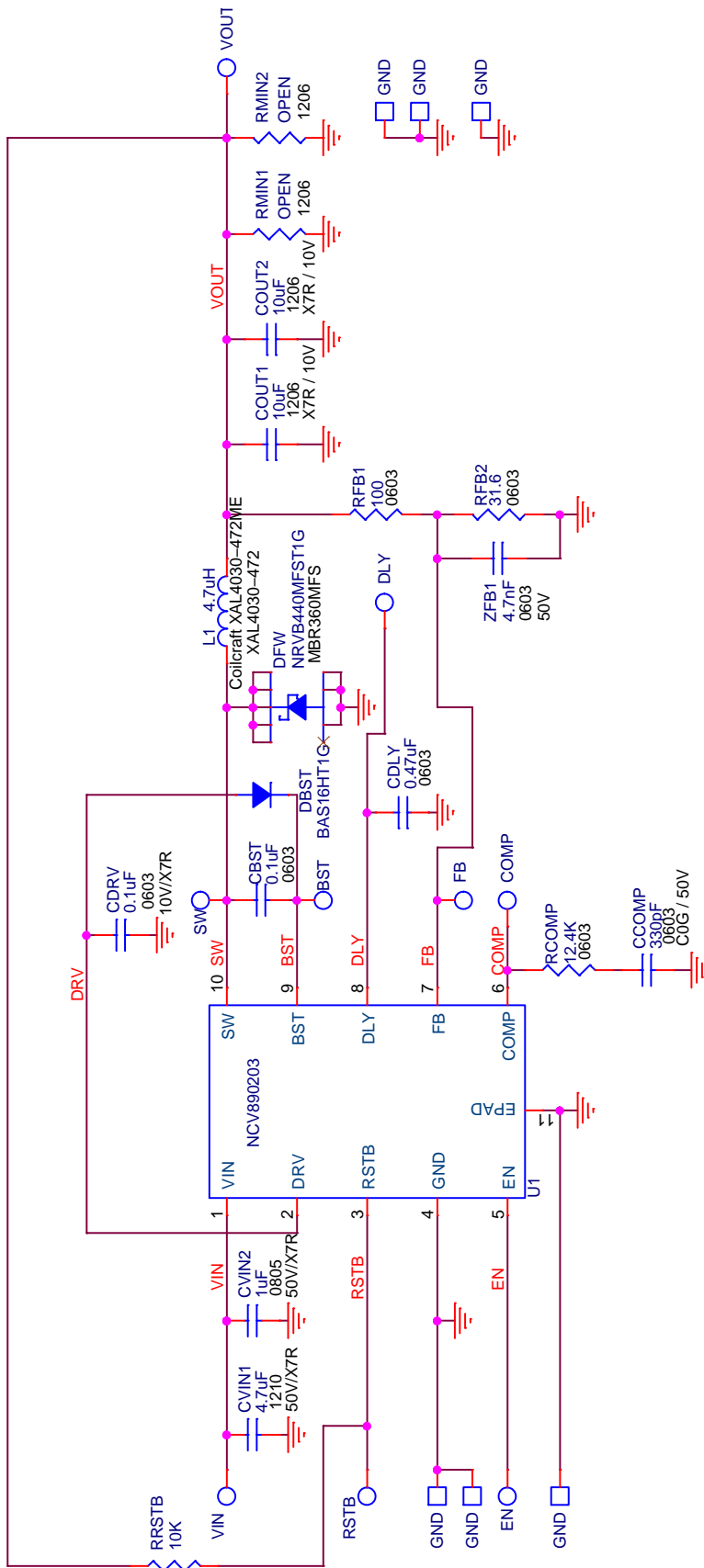

Figure 13. Schematic

NCV890203GEVB

PCB LAYOUT

NCV890203 Demo Board Rev. 1 – 04/15/14
TOP Layer

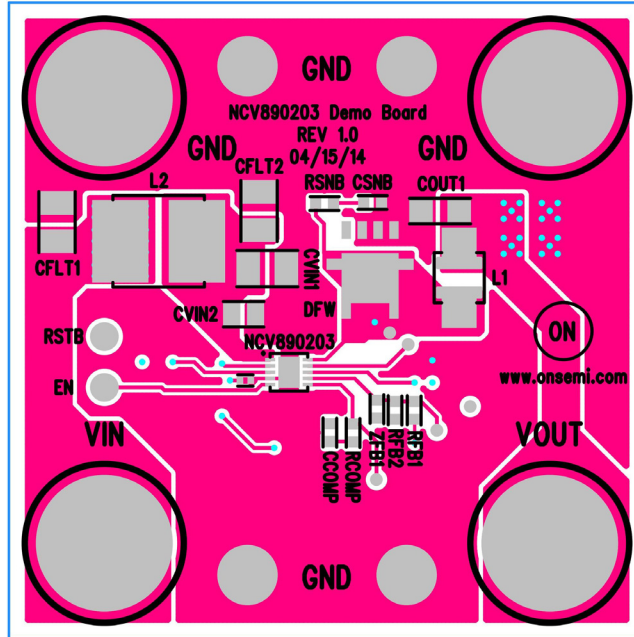

Figure 14. Top View

NCV890203 Demo Board Rev. 1 – 04/15/14
BOTTOM Layer (mirrored)

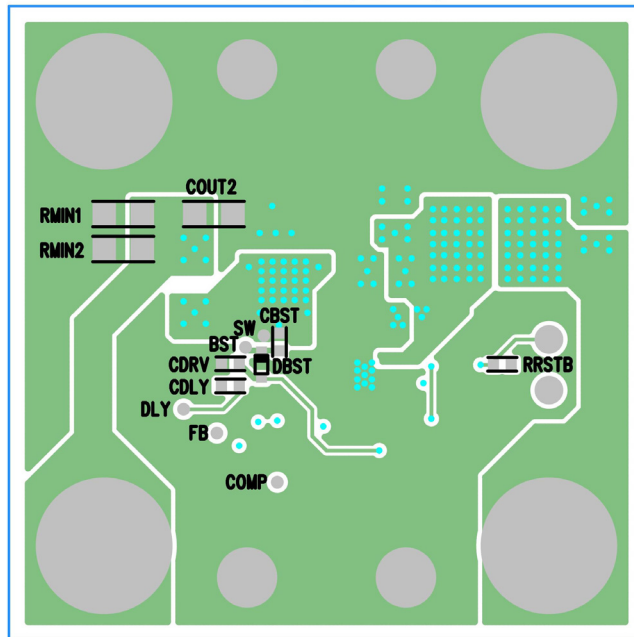

Figure 15. Bottom View

NCV890203GEVB

BILL OF MATERIALS

Table 4. BILL OF MATERIALS

Reference Designator(s)	Qty.	Description	Value	Tolerance	Footprint	Manufacturer	Manufacturer's Part Number	Substitution Allowed
CBST, CDRV	2	CAP.10 μ F 10 V CERAMIC X7R 0603	0.1 μ F	10%	603	Kemet	C0603C104K8RACTU	Yes
CCOMP	1	CAP CER 330 pF 50 V C0G 0603	330 pF	10%	603	Murata Electronics North America	GCM1885C1H331JA16D	Yes
CDLY	1	CAP CER 0.47 μ F 25 V 10% X7R 0603	0.47 μ F	10%	603	Murata Electronics North America	GCM188R71E474KA64D	Yes
CFLT1, CFLT2, CVIN1	3	CAP CER 4.7 μ F 50 V 10% X7R 1210	4.7 μ F	10%	1210	Murata Electronics North America	GRM32ER71H475KA88L	Yes
COUT1, COUT2	2	CAP CER 10 μ F 10 V 10% X7R 1206	10 μ F	10%	1206	Taiyo Yuden	LMK316AB7106KLHT	Yes
CVIN2	1	CAP CER 1.0 μ F 50 V X5R 0805	1.0 μ F	10%	805	Murata Electronics North America	UMK212BJ105KG-T	Yes
DBST	1	DIODE SWITCH 200 mA 75 V SOD323	75 V/0.2 A	N/A	SOD_323	ON Semiconductor	BAS16HT1G	No
DFW	1	DIODE SCHOTTKY 4.0 A 40 V SMB	40 V/4.0 A	N/A	SMB_DIODE	ON Semiconductor	NRVB440MFST1G	No
L1	1	INDUCTOR POWER 4.7 μ H 4.5 A 20% SMD	4.7 μ H	4.5A	XAL4030-472	Coilcraft	XAL4030-472ME	No
*L2	1	RES 0.0 Ω 1/4 W JUMP 1206 SMD	0 Ω	5%	1206	Yageo	RC1206JR-070RL	Yes
RCOMP	1	RES 6.98 k Ω 1/10 W 1% 0603 SMD	6.98 k Ω	1%	603	Vishay/Dale	CRCW06036K98FKEA	Yes
RFB1	1	RES 100 Ω 1/10 W 1% 0603 SMD	100 Ω	1%	603	Vishay/Dale	CRCW0603100RFKEA	Yes
RFB2	1	RES 31.6 Ω 1/10 W 1% 0603 SMD	31.6 Ω	1%	603	Vishay/Dale	CRCW060331R6FKEA	Yes
RRSTB	1	RES 10.0 k Ω 1/10 W 1% 0603 SMD	10.0 k Ω	1%	603	Vishay/Dale	CRCW060310K0FKEA	Yes
ZFB1	1	CAP CER 4700 PF 50 V 10% X7R 0603	4700 pF	10%	603	Murata Electronics North America	GRM188R71H472KA01D	Yes
CSNB	1		Do Not Populate		603			Yes
RMIN1, RMIN2	2		Do Not Populate		1206			Yes
RSNB	1		Do Not Populate		603			Yes
BST, COMP, DLY, FB, RDEP, RMOD, SW	7	CIRCUIT PIN PRNTD .020"D .425"L	Do Not Populate	N/A	TPA	Mill-Max Manufacturing Corp.	3128-2-00-15-00-00-08-0	Yes
GND1, GND2, VIN, VOUT	4	CONN JACK BANANA UNINS PANEL MOU	N/A	N/A	BANANA	Emerson Network Power Connectivity Solutions	108-0740-001	Yes

NCV890203GEVB

Table 4. BILL OF MATERIALS (continued)

Reference Designator(s)	Qty.	Description	Value	Tolerance	Footprint	Manufacturer	Manufacturer's Part Number	Substitution Allowed
GND3-GND6	4	TERM SOLDER TURRET .219" .109"L	N/A	N/A	TURRET	Mill-Max Manufacturing Corp.	2501-2-00-44-00-00-07-0	Yes
EN, RSTB	2	PIN INBOARD .042" HOLE 1000/PKG	N/A	N/A	TP	Vector Electronics	K24C/M	Yes
NCV890203	1	2.0 A 2 MHz Automotive Buck Switching Regulator	NCV890203	N/A	10PINDFNP5	ON Semiconductor	NCV890203MWTXG	No

*L2 is a placeholder footprint for an optional input inductor filter component. Boards are shipped with a shorting jumper installed to complete the input path.

NOTE: All devices are RoHS Compliant.

ON Semiconductor and  are registered trademarks of Semiconductor Components Industries, LLC (SCILLC). SCILLC owns the rights to a number of patents, trademarks, copyrights, trade secrets, and other intellectual property. A listing of SCILLC's product/patent coverage may be accessed at www.onsemi.com/site/pdf/Patent-Marking.pdf. SCILLC reserves the right to make changes without further notice to any products herein. SCILLC makes no warranty, representation or guarantee regarding the suitability of its products for any particular purpose, nor does SCILLC assume any liability arising out of the application or use of any product or circuit, and specifically disclaims any and all liability, including without limitation special, consequential or incidental damages. "Typical" parameters which may be provided in SCILLC data sheets and/or specifications can and do vary in different applications and actual performance may vary over time. All operating parameters, including "Typicals" must be validated for each customer application by customer's technical experts. SCILLC does not convey any license under its patent rights nor the rights of others. SCILLC products are not designed, intended, or authorized for use as components in systems intended for surgical implant into the body, or other applications intended to support or sustain life, or for any other application in which the failure of the SCILLC product could create a situation where personal injury or death may occur. Should Buyer purchase or use SCILLC products for any such unintended or unauthorized application, Buyer shall indemnify and hold SCILLC and its officers, employees, subsidiaries, affiliates, and distributors harmless against all claims, costs, damages, and expenses, and reasonable attorney fees arising out of, directly or indirectly, any claim of personal injury or death associated with such unintended or unauthorized use, even if such claim alleges that SCILLC was negligent regarding the design or manufacture of the part. SCILLC is an Equal Opportunity/Affirmative Action Employer. This literature is subject to all applicable copyright laws and is not for resale in any manner.

PUBLICATION ORDERING INFORMATION

LITERATURE FULFILLMENT:

Literature Distribution Center for ON Semiconductor
P.O. Box 5163, Denver, Colorado 80217 USA
Phone: 303-675-2175 or 800-344-3860 Toll Free USA/Canada
Fax: 303-675-2176 or 800-344-3867 Toll Free USA/Canada
Email: orderlit@onsemi.com

N. American Technical Support: 800-282-9855 Toll Free
USA/Canada
Europe, Middle East and Africa Technical Support:
Phone: 421 33 790 2910
Japan Customer Focus Center
Phone: 81-3-5817-1050

ON Semiconductor Website: www.onsemi.com
Order Literature: <http://www.onsemi.com/orderlit>
For additional information, please contact your local Sales Representative



Компания «ЭлектроПласт» предлагает заключение долгосрочных отношений при поставках импортных электронных компонентов на взаимовыгодных условиях!

Наши преимущества:

- Оперативные поставки широкого спектра электронных компонентов отечественного и импортного производства напрямую от производителей и с крупнейших мировых складов;
- Поставка более 17-ти миллионов наименований электронных компонентов;
- Поставка сложных, дефицитных, либо снятых с производства позиций;
- Оперативные сроки поставки под заказ (от 5 рабочих дней);
- Экспресс доставка в любую точку России;
- Техническая поддержка проекта, помощь в подборе аналогов, поставка прототипов;
- Система менеджмента качества сертифицирована по Международному стандарту ISO 9001;
- Лицензия ФСБ на осуществление работ с использованием сведений, составляющих государственную тайну;
- Поставка специализированных компонентов (Xilinx, Altera, Analog Devices, Intersil, Interpoint, Microsemi, Aeroflex, Peregrine, Syfer, Eurofarad, Texas Instrument, Miteq, Cobham, E2V, MA-COM, Hittite, Mini-Circuits, General Dynamics и др.);

Помимо этого, одним из направлений компании «ЭлектроПласт» является направление «Источники питания». Мы предлагаем Вам помощь Конструкторского отдела:

- Подбор оптимального решения, техническое обоснование при выборе компонента;
- Подбор аналогов;
- Консультации по применению компонента;
- Поставка образцов и прототипов;
- Техническая поддержка проекта;
- Защита от снятия компонента с производства.



Как с нами связаться

Телефон: 8 (812) 309 58 32 (многоканальный)

Факс: 8 (812) 320-02-42

Электронная почта: org@eplast1.ru

Адрес: 198099, г. Санкт-Петербург, ул. Калинина, дом 2, корпус 4, литера А.