

## Features

- Formerly J. W. Miller® model
- Six windings - multiple configurations
- Compact size
- Tape and reel packaging
- RoHS compliant\*

## Applications

- Inductors: Buck-boost, coupled, filtering, common mode
- Transformers: Flyback, push-pull, inverter, gate drive, isolation

## PM600/PM610/PM620 Series - SMD Inductor/Transformer

### Electrical Specifications

Bourns Part No.	Inductance 100 KHz		DCR (Ω) Max.	Isat (A)	Irms (A)	<1> ET (VmS) Based on 40 °C Rise (260 KHz)	<1> ET (VmS) Based on Core Saturation
	(μH)	Tol. (%)					
PM600-01-RC	201.6	±30	0.324	0.02	0.46	16.8	103.2
PM600-02-RC	89.6	±30	0.137	0.03	0.71	11.2	68.8
PM600-03-RC	27.4	±10	0.324	0.31	0.46	16.8	103.2
PM600-04-RC	12.2	±10	0.137	0.47	0.71	11.2	68.8
PM600-05-RC	14.7	±10	0.324	0.58	0.46	16.8	103.2
PM600-06-RC	6.5	±10	0.137	0.87	0.71	11.2	68.8
PM600-07-RC	10.9	±10	0.324	0.88	0.46	16.8	103.2
PM600-08-RC	4.9	±10	0.137	1.32	0.71	11.2	68.8
PM600-09-RC	8.5	±10	0.324	1.23	0.46	16.8	103.2
PM600-10-RC	3.8	±10	0.137	1.85	0.71	11.2	68.8
PM610-01-RC	160.0	±30	0.202	0.04	0.68	21.0	130
PM610-02-RC	78.4	±30	0.094	0.06	1.00	14.7	91
PM610-03-RC	21.6	±10	0.202	0.67	0.68	21.0	130
PM610-04-RC	10.6	±10	0.094	0.96	1.00	14.7	91
PM610-05-RC	11.6	±10	0.202	1.30	0.68	21.0	130
PM610-06-RC	5.7	±10	0.094	1.86	1.00	14.7	91
PM610-07-RC	8.3	±10	0.202	2.00	0.68	21.0	130
PM610-08-RC	4.1	±10	0.094	2.86	1.00	14.7	91
PM610-09-RC	6.6	±10	0.202	2.30	0.68	21.0	130
PM610-10-RC	3.2	±10	0.094	3.29	1.00	14.7	91
PM620-01-RC	160.6	±30	0.094	0.03	1.28	20.8	130
PM620-02-RC	77.0	±30	0.065	0.04	1.54	14.4	90
PM620-03-RC	131.8	±20	0.094	0.08	1.28	20.8	130
PM620-04-RC	63.2	±20	0.065	0.12	1.54	14.4	90
PM620-05-RC	23.3	±10	0.094	0.36	1.28	20.8	130
PM620-06-RC	11.2	±10	0.065	0.52	1.54	14.4	90
PM620-07-RC	14.2	±10	0.094	0.76	1.28	20.8	130
PM620-08-RC	6.8	±10	0.065	1.10	1.54	14.4	90
PM620-09-RC	9.3	±10	0.094	1.11	1.28	20.8	130
PM620-10-RC	4.5	±10	0.065	1.60	1.54	14.4	90
PM620-11-RC	7.9	±10	0.094	1.40	1.28	20.8	130
PM620-12-RC	3.8	±10	0.065	2.02	1.54	14.4	90

<1> Single or multi-windings in parallel. ET of multiple winding in series is number of windings times value of ET.

### General Specifications

Rated Current..... Ind. drop of 30 % typ.  
 .....at Isat  
 Temperature Rise ... 40 °C typical at Irms  
 Operating Temperature  
 .....-40 °C to +105 °C  
 Storage Temperature  
 .....-40 °C to +105 °C  
 Soldering ..... 245 °C, 5 seconds max.  
 Dielectric Strength ..... 500 Vrms  
 between windings

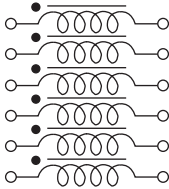
### Materials

Core..... Ferrite  
 Wire ..... Polyurethane-coated copper  
 Terminal Coating..... Sn-Ag-Cu alloy  
 Packaging  
 PM600.....600 pcs. per 13-inch reel  
 PM610.....300 pcs. per 13-inch reel  
 PM620.....200 pcs. per 13-inch reel

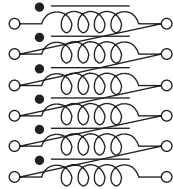
\*RoHS Directive 2002/95/EC Jan. 27, 2003 including annex and RoHS Recast 2011/65/EU June 8, 2011. Specifications are subject to change without notice. Customers should verify actual device performance in their specific applications.

Typical Configurations

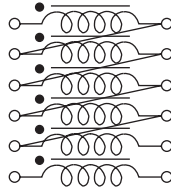
**Inductor:**



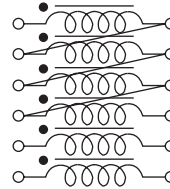
*Basic Diagram*  
Inductance: L  
Current: I



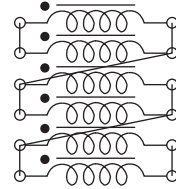
*Figure 1*  
Inductance: 36 x L  
Current: I



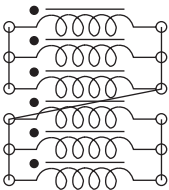
*Figure 2*  
Inductance: 25 x L  
Current: I



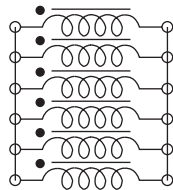
*Figure 3*  
Inductance: 16 x L  
Current: I



*Figure 4*  
Inductance: 9 x L  
Current: 2 x I

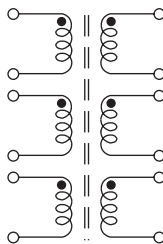


*Figure 5*  
Inductance: 4 x L  
Current: 3 x I

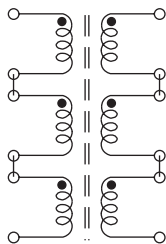


*Figure 6*  
Inductance: L  
Current: 6 x I

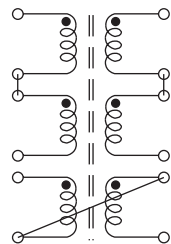
**Transformer:**



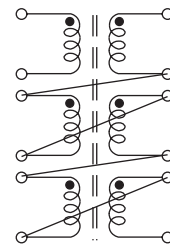
*Basic Diagram*  
Turns Ratio:  
1:1:1:1:1



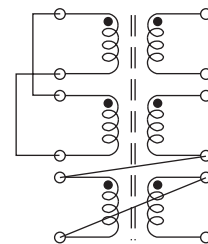
*Figure 1*  
Turns Ratio:  
1:1



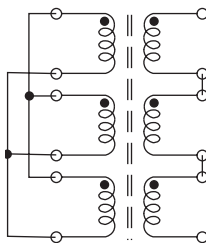
*Figure 2*  
Turns Ratio:  
1:1:1



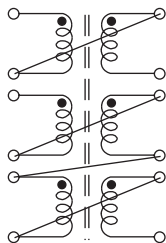
*Figure 3*  
Turns Ratio:  
1:5 or 5:1



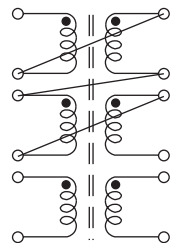
*Figure 4*  
Turns Ratio:  
1:4 or 4:1



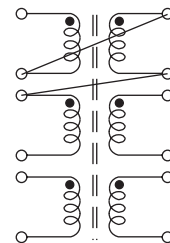
*Figure 5*  
Turns Ratio:  
1:3 or 3:1



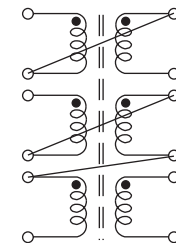
*Figure 6*  
Turns Ratio:  
1:2 or 2:1



*Figure 7*  
Turns Ratio:  
4:1:1



*Figure 8*  
Turns Ratio:  
3:1:1:1



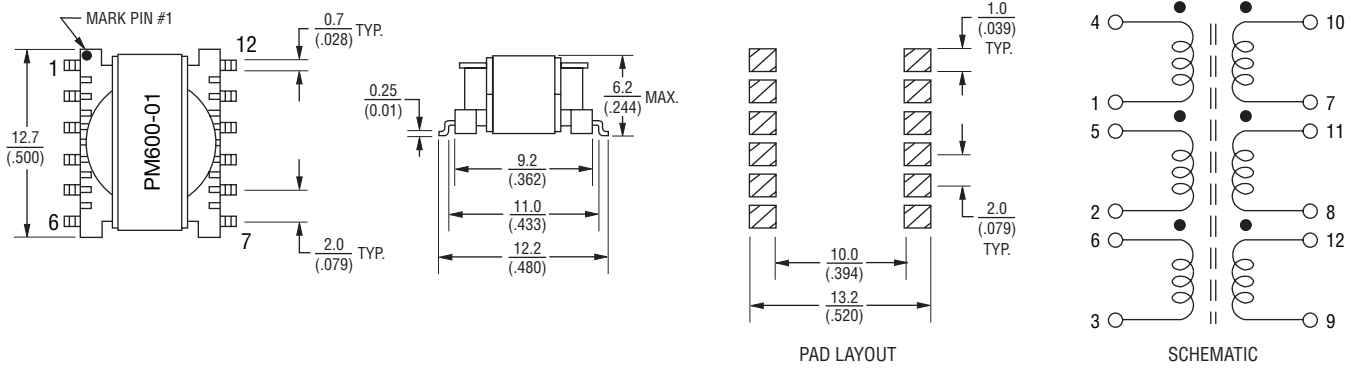
*Figure 9*  
Turns Ratio:  
2:3 or 3:2

# PM600/PM610/PM620 Series - SMD Inductor/Transformer

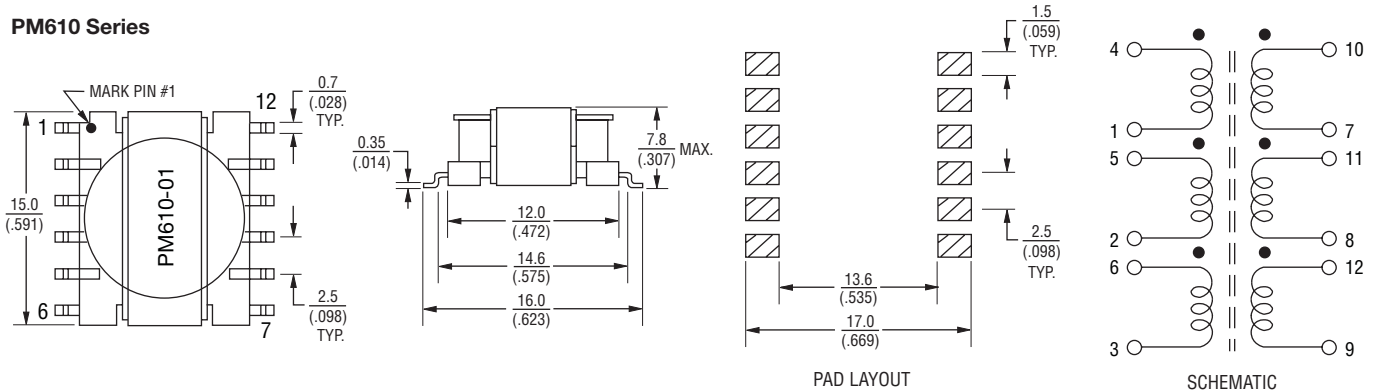
**BOURNS®**

## Product Dimensions

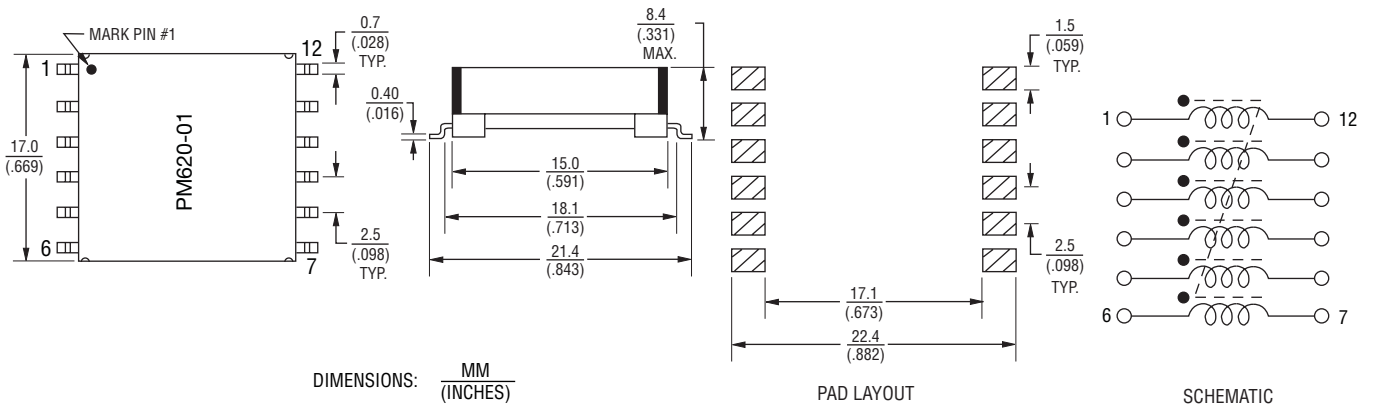
### PM600 Series



### PM610 Series



### PM620 Series



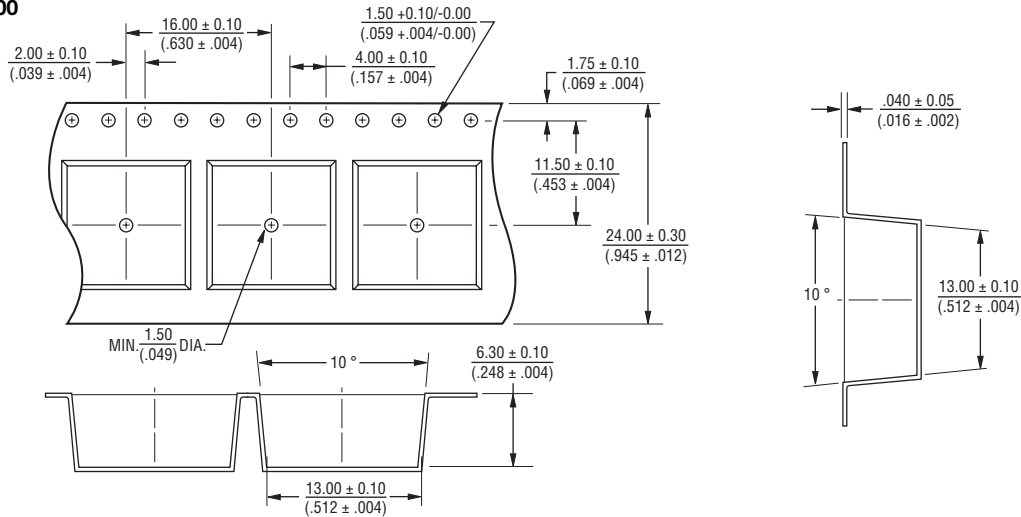
Specifications are subject to change without notice.  
Customers should verify actual device performance in their specific applications.

# PM600/PM610/PM620 Series - SMD Inductor/Transformer

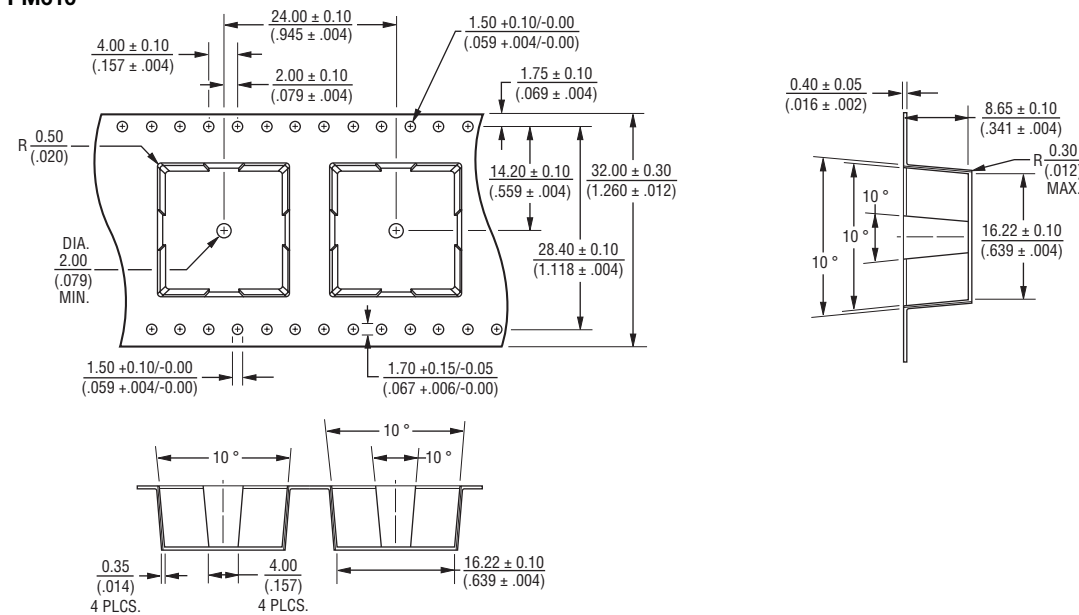
# BOURNS®

## Packaging Specifications

### PM600



### PM610



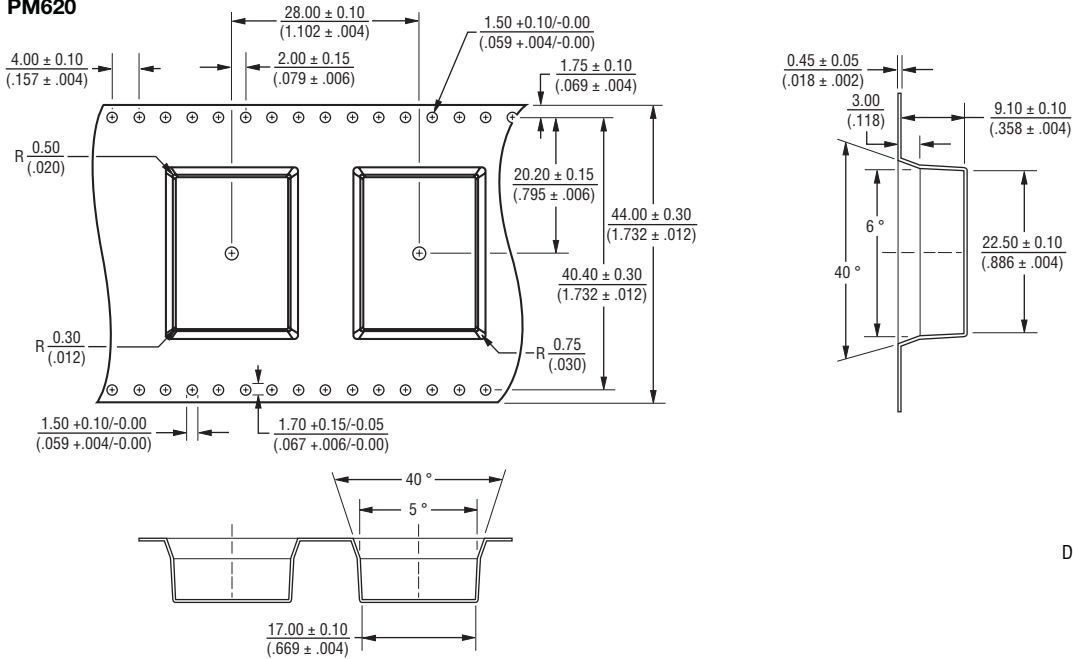
DIMENSIONS:  $\frac{MM}{(INCHES)}$

# PM600/PM610/PM620 Series - SMD Inductor/Transformer

**BOURNS®**

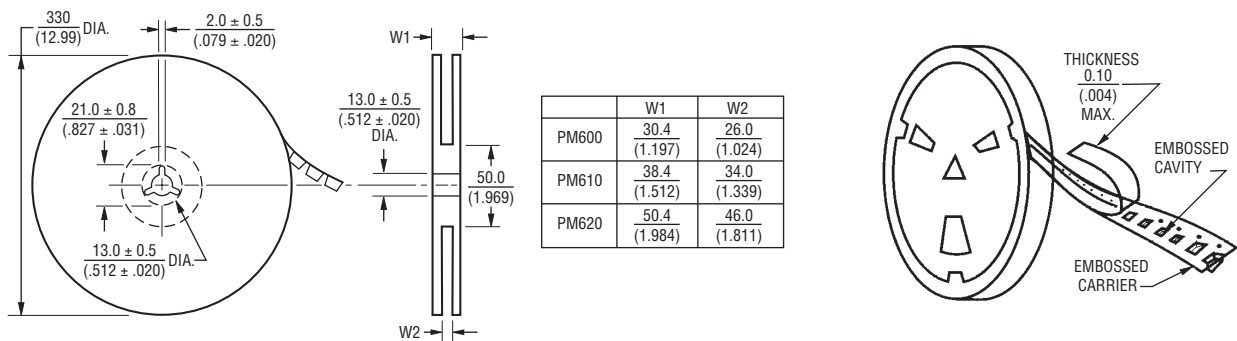
## Packaging Specifications (Continued)

### PM620



DIMENSIONS:  $\frac{\text{MM}}{\text{(INCHES)}}$

<1> Single or multi-windings in parallel. ET of multiple winding in series is number of windings times value of ET.



REV. 06/08

Specifications are subject to change without notice.  
Customers should verify actual device performance in their specific applications.



Компания «ЭлектроПласт» предлагает заключение долгосрочных отношений при поставках импортных электронных компонентов на взаимовыгодных условиях!

Наши преимущества:

- Оперативные поставки широкого спектра электронных компонентов отечественного и импортного производства напрямую от производителей и с крупнейших мировых складов;
- Поставка более 17-ти миллионов наименований электронных компонентов;
- Поставка сложных, дефицитных, либо снятых с производства позиций;
- Оперативные сроки поставки под заказ (от 5 рабочих дней);
- Экспресс доставка в любую точку России;
- Техническая поддержка проекта, помощь в подборе аналогов, поставка прототипов;
- Система менеджмента качества сертифицирована по Международному стандарту ISO 9001;
- Лицензия ФСБ на осуществление работ с использованием сведений, составляющих государственную тайну;
- Поставка специализированных компонентов (Xilinx, Altera, Analog Devices, Intersil, Interpoint, Microsemi, Aeroflex, Peregrine, Syfer, Eurofarad, Texas Instrument, Miteq, Cobham, E2V, MA-COM, Hittite, Mini-Circuits, General Dynamics и др.);

Помимо этого, одним из направлений компании «ЭлектроПласт» является направление «Источники питания». Мы предлагаем Вам помощь Конструкторского отдела:

- Подбор оптимального решения, техническое обоснование при выборе компонента;
- Подбор аналогов;
- Консультации по применению компонента;
- Поставка образцов и прототипов;
- Техническая поддержка проекта;
- Защита от снятия компонента с производства.



#### Как с нами связаться

**Телефон:** 8 (812) 309 58 32 (многоканальный)

**Факс:** 8 (812) 320-02-42

**Электронная почта:** [org@eplast1.ru](mailto:org@eplast1.ru)

**Адрес:** 198099, г. Санкт-Петербург, ул. Калинина, дом 2, корпус 4, литера А.