

## Description

Single pole, miniaturised thermal circuit breaker with trip-free mechanism and push/pull on/off manual actuation (M-type TO CBE to EN 60934). Threadneck panel mounted, temperature-compensated, with optional auxiliary contacts. Fully approved for commercial aircraft and similar requirements.

Various dummies are available without protective function, allowing connection of pre-installed wiring without loads.

**US patent number:** US 6,490,141 B2 (4120-G4 moulded threadneck)

## Typical applications

Extra low voltage wiring systems on all types of vehicles for land, sea and air.

## Ordering information

### Type No.

4120 single pole, with temperature compensation

### Mounting

**G** threadneck panel mounting

### Threadneck design

**1** M12x1x6.3 (aluminium)

**2** 7/16-32 UNx6.3 (aluminium)

### Number of poles

**1** 1-pole, thermally protected

### Hardware for threadneck

**0** without hardware

**1** hex nut M12x1, corrugated washer 12/15, fitted

**3** hex nut M12x1 (aluminium), serrated lock washer 12.1/17.2, bulk shipped

**4** hex nut 7/16-32UN (aluminium), serrated lock washer 11.3/14.9, fitted

### Terminal design (main terminals)

**K1** screw terminals with metric thread K14 (M4)

**J1** screw terminals with inch thread J14 (8-32UNC-2B)

**J2** screw terminals with inch thread J17 (8-32UNC-2B)

**J3** screw terminals with inch thread J25 (6-32UNC-2B)

**P1** blade terminals 6.3x0.8, DIN 46244, silver-plated

### Characteristic curve

**M1** thermal, 1.15 - 1.4 I<sub>N</sub>

### Terminal screws

**A** Phillips screw M4x6, fitted

**B** Phillips screw 8-32UNC-2Ax6, fitted

**C** Phillips screw 6-32UNC-2Ax6 (MS 51957-26)

**K** hex screw with Phillips head 8-32UNC-3Ax7.6, fitted

**M** hex screw with Phillips head 8-32UNC-3Ax7.6, bulk shipped

**Z** without terminal hardware

### Terminal washers

**0** without lock washer

**1** wave washer A4, fitted

**2** lock washer 4.3, fitted

**4** lock washer 3.7 (MS 35338-136)

**5** lock washer 4.3/9, fitted

**6** lock washer 4.3/9, bulk shipped

### Auxiliary contact

**S0** without auxiliary contact

**S1** with auxiliary contact (connector EN 3155-016M2018) (NC)

**S5** with polarized auxiliary contact (NC)

### Barrier

**Z** without barrier

### Colour of the push button

**G** green to EN (e. g. 2 1/2)

**N** black to EN (e. g. 2 1/2)

### Current ratings

**1...25 A**

4120 - G 1 1 1 - K1 M1 - A 1 S0 Z N - 10 A ordering example



4120-...

## Technical data

|   |  |                           |         |
|---|--|---------------------------|---------|
| Voltage rating                                  | AC 115 V (300 Hz to 800 Hz); DC 28 V   |                           |         |
| Current rating range                            | 1...25 A (0.5 A upon request)  |                           |         |
| Auxiliary circuit                               | 1 A, DC 28 V (0.5 A upon request)  |                           |         |
| Typical life                                    | 20,000 operations mechanical, or 5,000 operations at 1 x I <sub>N</sub>  |                           |         |
| Ambient temperature                             | -55°C ...+125°C (-67...+257 °F)  |                           |         |
| Insulation co-ordination (IEC 60664 and 60664A) | rated impulse withstand voltage  | pollution degree 3        |         |
| Dielectric strength (IEC 60664 and 60664A)      | test voltage   | operating area AC 1,500 V |         |
|   | main to aux. circuit   | AC 1,500 V                |         |
| Insulation resistance                           | > 100 MΩ (DC 500 V)  |                           |         |
| Interrupting capacity I <sub>cn</sub>           | AC 115 V (400 Hz):   | 1...4 A                   | 1,000 A |
|   |  | 5...25 A                  | 2,000 A |
|   | DC 28 V:   | 1...25 A                  | 6,000 A |
| Degree of protection (IEC 60529/DIN 40050)      | operating area IP40<br>terminal area IP00  |                           |         |
| Vibration (sinusoidal)                          | 10 g (57-2000 Hz), ± 0.76 mm (5-57 Hz) to ISO 7137, EN 2350 para. 5.3.1  |                           |         |
| Vibration                                       | 1...2.5 A: 0.04 g <sup>2</sup> /Hz ± 1.5 dB; 7.3 g eff<br>3...20 A: 0.06 g <sup>2</sup> /Hz ± 1.5 dB; 9 g eff to ISO 7137, EN 2350 para. 5.3.1 |                           |         |
| Acceleration                                    | 17 g, to ISO 2669, EN 2350 para. 5.3.3   |                           |         |
| Shock   | 50 g (11 ms), to ISO 7137, EN 2350 para. 5.3.2   |                           |         |
| Corrosion                                       | 48 hours at 5 % salt mist to ISO 7137, EN 2350 para. 5.4.2   |                           |         |
| Humidity  | 240 hours at 95 % RH, to ISO 7137, EN 2350 para. 5.4.3   |                           |         |
| Explosion                                       | to VG 95210, sheet 10  |                           |         |
| Altitude  | ≤ 22,000 m above sea level   |                           |         |
| Mass  | approx. 20.6 g with terminal screws, without -Si<br>approx. 24.6 g with terminal screws, with -Si  |                           |         |

## Preferred types

| Preferred types                             | Standard current ratings (A) |   |   |   |     |    |    |    |    |
|---|------------------------------|---|---|---|-----|----|----|----|----|
|   | 1                            | 2 | 3 | 5 | 7.5 | 10 | 15 | 20 | 25 |
| 4120-G214-J1M1-B2S0ZN (MS3320)              | x                            | x | x | x | x   | x  | x  | x  | x  |
| 4120-G111-K1M1-A1S0ZN (EN 2495/VG93345 T06) | x                            | x | x | x | x   | x  | x  | x  | x  |



## Mounting holes

### 4120-G2...

### mounting holes S0

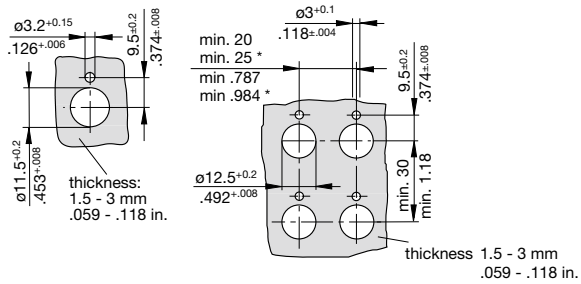

### 4120-G1...

### mounting holes S1 or S5

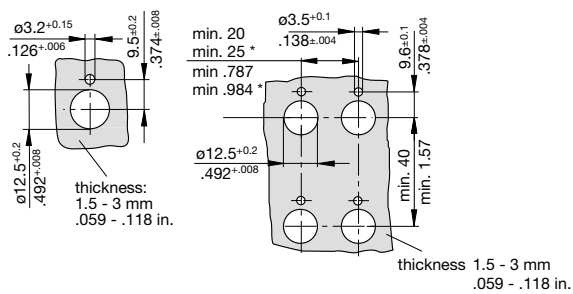

\* min. 25 mm / .984 in. when fitted with splash cover

## Internal connection diagram

### with auxiliary contact VG 95345 T06

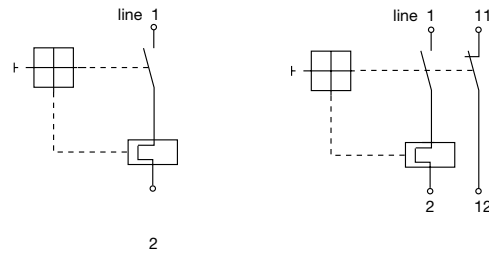

### with auxiliary contact EN 2995-004

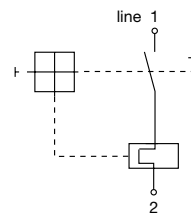

### with polarized auxiliary contact EN 2995-005

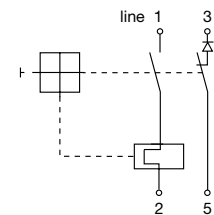

## Other terminal designs

### Terminal design -J2

Terminal distances to:  
MS 14 105 (a, b)  
MS 14 153 (a, b)  
MS 22 073 (a)  
MS 22 074 (a)  
MS 25 244 (a)  
MS 25 373 (a, b)

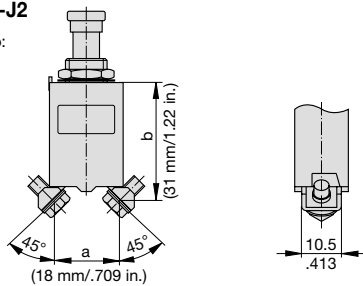

### Terminal design -J3

Terminal distances to:  
MS 26 574 (a, b)

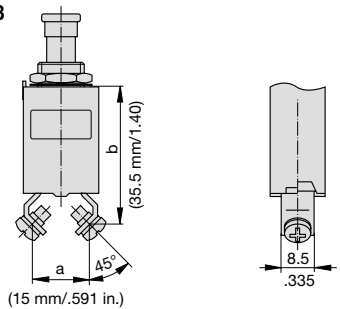

### Terminal design -P1

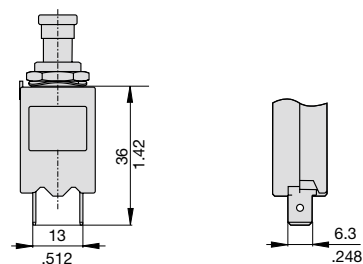

## Typical time/current characteristics

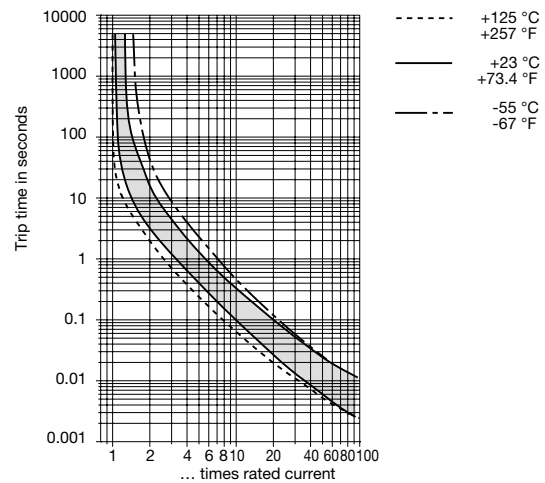

**Accessories (approved to VG 95 345, part 23)**

**Splash cover/hex nut assembly with O ring (IP66 and IP67)**  
 X 200 801 08 nickel plated nut, transparent cover  
 X 200 801 03 matt black finish nut, black cover  
 X 200 801 09 matt black finish nut/7/16-32, black cover  
 X 200 801 12 with blackened nut and transparent cover

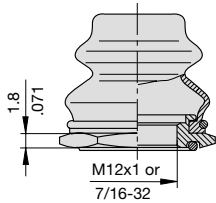

**Actuator extension (black) to be fitted on the push button**  
 X 200 803 01

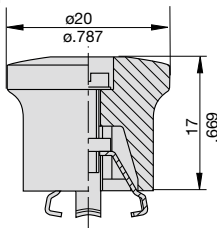

**Accessories**

**Identification collar to be snapped on the push button**  
 Y 307 004 01 black  
 Y 307 004 02 white  
 Y 307 004 03 red  
 Y 307 004 04 green  
 Y 307 004 05 blue

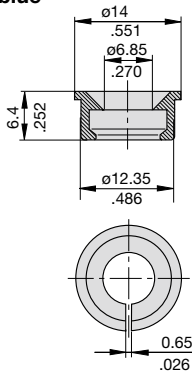

**Lock out ring to block the push button in OFF position**  
 Y 307 005 01 red  
 Y 307 005 02 black

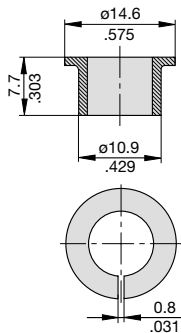

This is a metric design and millimeter dimensions take precedence ( $\frac{\text{mm}}{\text{inch}}$ )

All dimensions without tolerances are for reference only. In the interest of improved design, performance and cost effectiveness the right to make changes in these specifications without notice is reserved. Product markings may not be exactly as the ordering codes. Errors and omissions excepted.



Компания «ЭлектроПласт» предлагает заключение долгосрочных отношений при поставках импортных электронных компонентов на взаимовыгодных условиях!

Наши преимущества:

- Оперативные поставки широкого спектра электронных компонентов отечественного и импортного производства напрямую от производителей и с крупнейших мировых складов;
- Поставка более 17-ти миллионов наименований электронных компонентов;
- Поставка сложных, дефицитных, либо снятых с производства позиций;
- Оперативные сроки поставки под заказ (от 5 рабочих дней);
- Экспресс доставка в любую точку России;
- Техническая поддержка проекта, помощь в подборе аналогов, поставка прототипов;
- Система менеджмента качества сертифицирована по Международному стандарту ISO 9001;
- Лицензия ФСБ на осуществление работ с использованием сведений, составляющих государственную тайну;
- Поставка специализированных компонентов (Xilinx, Altera, Analog Devices, Intersil, Interpoint, Microsemi, Aeroflex, Peregrine, Syfer, Eurofarad, Texas Instrument, Miteq, Cobham, E2V, MA-COM, Hittite, Mini-Circuits, General Dynamics и др.);

Помимо этого, одним из направлений компании «ЭлектроПласт» является направление «Источники питания». Мы предлагаем Вам помощь Конструкторского отдела:

- Подбор оптимального решения, техническое обоснование при выборе компонента;
- Подбор аналогов;
- Консультации по применению компонента;
- Поставка образцов и прототипов;
- Техническая поддержка проекта;
- Защита от снятия компонента с производства.



#### Как с нами связаться

**Телефон:** 8 (812) 309 58 32 (многоканальный)

**Факс:** 8 (812) 320-02-42

**Электронная почта:** [org@eplast1.ru](mailto:org@eplast1.ru)

**Адрес:** 198099, г. Санкт-Петербург, ул. Калинина, дом 2, корпус 4, литера А.