

Contents

Product Program	2
Mechanical Data	2
Connections	2
Absolute Maximum Ratings	3
Input	3
Product Qualification Specification	4
Safety Specification	5
Adjusted to 1.0 Vout - Data	6
Adjusted to 1.2 Vout - Data	9
Adjusted to 1.5 Vout - Data	12
Adjusted to 1.8 Vout - Data	15
Adjusted to 2.5 Vout - Data	18
Adjusted to 3.3 Vout - Data	21
Adjusted to 5.0 Vout - Data	24
EMC Specification	27
Operating Information	28
Thermal Considerations	30
Soldering Information	31
Delivery Package Information	31
Compatibility with RoHS requirements	31
Reliability	31
Sales Offices and Contact Information	32

The PMB series of SIL DC/DC regulators (POL) are intended to be used as local distributed power sources in distributed power architecture. The single in-line design makes the PMB series suitable for applications where boardspace is limited. The high efficiency and high reliability of the PMB series makes them particularly suited for the communications equipment of today and tomorrow.

DC/DC regulator Input 8.3 - 16 V Output 16 A

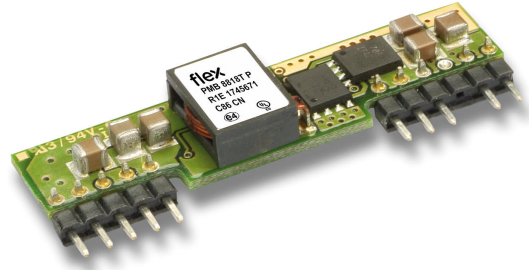

Key Features

- Wide input, 8.3 - 16 Vdc
- Programmable output, 0.75 - 5.5 Vdc
- Monotonic start up into pre-biased output
- Under voltage protection
- Short circuit protection
- Remote sense
- Remote On/Off
- Design for Environment (DfE)
- European Commission Directive 2011/65/EU (RoHs) compliant

These products are manufactured using the most advanced technologies and materials to comply with environmental requirements. Designed to meet high reliability requirements of systems manufacturers, the PMB responds to world-class specifications.

Flex is an ISO 9001/14001 certified supplier.

Product Program

V_I	V_O/I_O max	P_O max	Ordering No.	Comment
	Output 1			
8.3 - 16 V	0.75 - 5.50/16 A	80 W	PMB 8818T P	Released

Option	Suffix	Example
Negative Remote Control logic	N	PMB 8818T PN

Mechanical Data

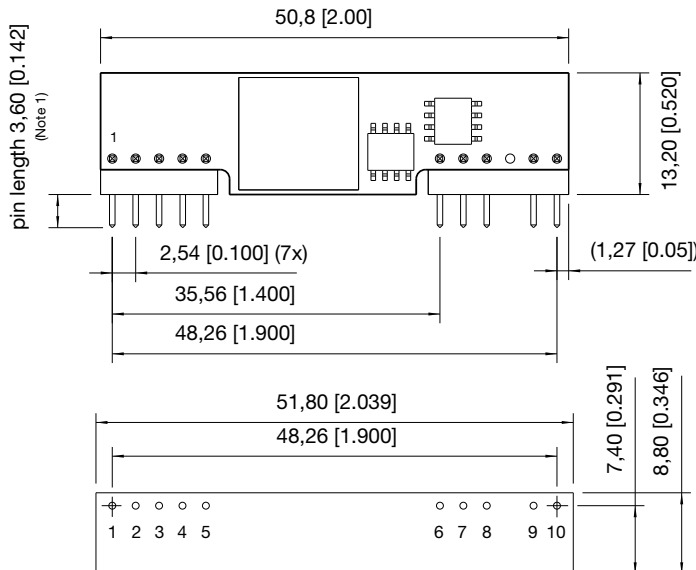

Recommended footprint (customer board), no components within border.
Holes: $\varnothing 1,0$ [0.04] through plated holes with $\varnothing 1,5$ [0.06] pads on both sides.

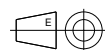
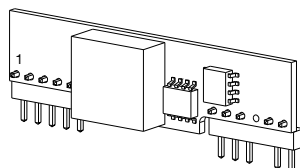
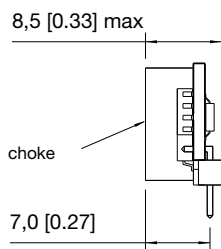

Dimensions in mm [inch]

Tolerances (unless specified):
x,x +/-0,5 [0.02]
x,xx +/-0,25 [0.01]

Connections

Pin	Designation	Function
1-2	+ Out	Output Voltage
3	+ S	Remote sensing
4	+ Out	Output Voltage
5	GND	Ground*
6	GND	Ground*
7-8	+ In	Input Voltage
9	Vadj	Output voltage adjust
10	RC	Remote control

* Should be connected together through a ground plane.

Weight

7.7g

Pins

Material: Copper alloy

Plating: Matte tin over nickel

Absolute Maximum Ratings

Characteristics		min	typ	max	Unit
T_{ref}	Maximum Operating Temperature, see thermal considerations	-45		+115	°C
T_S	Storage temperature	-55		+125	°C
V_I	Input voltage	-0.3		16	Vdc
V_{tr}	Input voltage transient	-0.3		40	Vdc
V_{RC}	Remote control voltage	Negative logic		16	Vdc
		Positive logic	-0.3	16	Vdc

Stress in excess of Absolute Maximum Ratings may cause permanent damage. Absolute Maximum Ratings, sometimes referred to as no destruction limits, are normally tested with one parameter at a time exceeding the limits of Output data or Electrical Characteristics. If exposed to stress above these limits, function and performance may degrade in an unspecified manner.

Input $T_{ref} = -30 \dots +90 \text{ }^\circ\text{C}$, $V_I = 8.3 \dots 16 \text{ V}$ unless otherwise specified
Typ values specified at: $T_{ref} = +25 \text{ }^\circ\text{C}$, V_{Inom} , $I_o \text{ max} = 16 \text{ A}$

Characteristics		Conditions	min	typ	max	Unit
V_I	Input voltage range		8.3	12	16	V
V_{loff}	Turn-off input voltage	$I_o \text{ max}$		7.8		V
V_{lon}	Turn-on input voltage	$I_o \text{ max}$		8.0		V
C_i	Input capacitance			30		μF
P_{ii}	Input idling power $I_o = 0 \text{ A}$, $V_I = 12 \text{ V}$	$V_o = 1.00 \text{ V}$		485	580	mW
		$V_o = 1.20 \text{ V}$		520	625	mW
		$V_o = 1.50 \text{ V}$		580	695	mW
		$V_o = 1.80 \text{ V}$		640	770	mW
		$V_o = 2.50 \text{ V}$		805	965	mW
		$V_o = 3.30 \text{ V}$		985	1180	mW
		$V_o = 5.00 \text{ V}$		1280	1520	mW
P_{RC}	Input stand-by power	$V_I = 12 \text{ V}$, RC activated		40		mW
V_{iac}	Input ripple 1) 20 Hz ... 5 MHz $V_I = 12 \text{ V}$, $I_o = 1.0 \times I_o \text{ max}$	$V_o = 1.00 \text{ V}$		170		mV _{p-p}
		$V_o = 1.20 \text{ V}$		190		mV _{p-p}
		$V_o = 1.50 \text{ V}$		210		mV _{p-p}
		$V_o = 1.80 \text{ V}$		250		mV _{p-p}
		$V_o = 2.50 \text{ V}$		310		mV _{p-p}
		$V_o = 3.30 \text{ V}$		350		mV _{p-p}
		$V_o = 5.00 \text{ V}$		450		mV _{p-p}

1) Measured with 4 x 4.7 μF ceramic capacitors

Fundamental Circuit Diagram

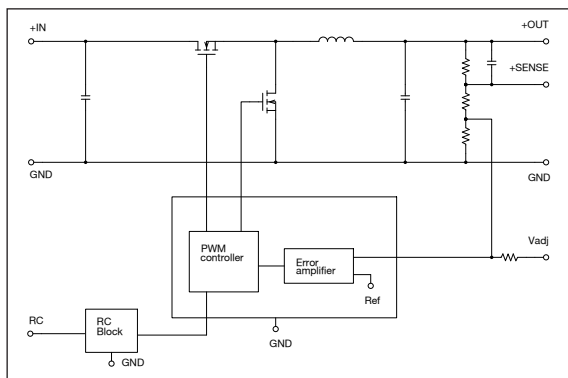

Product Qualification Specification

Characteristics			
Random Vibration	IEC 60068-2-64	Frequency Acceleration density	5 ... 500 Hz 0.5 g ² /Hz
Mechanical shock (half sinus)	IEC 60068-2-27	Peak acceleration Duration	50 g 11 ms
Lead integrity	IEC 60068-2-21 Ub	Simultaneous bending	All leads
Temperature cycling	JESD22-A104-B _G	Temperature Number of cycles	-40 ... +125 °C 300
Accelerated damp heat	JESD22-A101-B	Temperature Humidity Duration Bias	+85 °C 85 % RH 1000 hours max input voltage
Solderability	IEC 60068-2-54 (Aged according to JESD22-A101-B, 240h no bias)	Solder immersion depth Time for onset of wetting Wetting force	2 mm < 2.5 s > 200 mN/m
Cold (in operation)	IEC 60068-2-1	Temperature Duration	-45 °C 72 h
High temperature storage	JESD22-A103-B _A	Temperature Duration	+125 °C 1000 h

Safety Specification

General information.

Flex DC/DC converters and DC/DC regulators are designed in accordance with safety standards IEC/EN/UL 60 950, *Safety of Information Technology Equipment*.

IEC/EN/UL60950 contains requirements to prevent injury or damage due to the following hazards:

- *Electrical shock*
- *Energy hazards*
- *Fire*
- *Mechanical and heat hazards*
- *Radiation hazards*
- *Chemical hazards*

On-board DC-DC converters are defined as component power supplies. As components they cannot fully comply with the provisions of any Safety requirements without "Conditions of Acceptability". It is the responsibility of the installer to ensure that the final product housing these components complies with the requirements of all applicable Safety standards and Directives for the final product.

Component power supplies for general use should comply with the requirements in IEC60950, EN60950 and UL60950 "Safety of information technology equipment".

There are other more product related standards, e.g. IEC61204-7 "Safety standard for power supplies", IEEE802.3af "Ethernet LAN/MAN Data terminal equipment power", and ETS300132-2 "Power supply interface at the input to telecommunications equipment; part 2: DC", but all of these standards are based on IEC/EN/UL60950 with regards to safety.

Flex DC/DC converters and DC/DC regulators are UL 60 950 recognized and certified in accordance with EN 60 950.

The flammability rating for all construction parts of the products meets UL 94V-0.

The products should be installed in the end-use equipment, in accordance with the requirements of the ultimate application. Normally the output of the DC/DC converter is considered as SELV (Safety Extra Low Voltage) and the input source must be isolated by minimum Double or Reinforced Insulation from the primary circuit (AC mains) in accordance with IEC/EN/UL 60 950.

Isolated DC/DC converters.

It is recommended that a fast blow fuse with a rating twice the maximum input current per selected product be used at the input of each DC/DC converter. If an input filter is used in the circuit the fuse should be placed in front of the input filter.

In the rare event of a component problem in the input filter or in the DC/DC converter that imposes a short circuit on the input source, this fuse will provide the following functions:

- Isolate the faulty DC/DC converter from the input power source so as not to affect the operation of other parts of the system.
- Protect the distribution wiring from excessive current and power loss thus preventing hazardous overheating.

The galvanic isolation is verified in an electric strength test. The test voltage (V_{ISO}) between input and output is 1500 Vdc or 2250 Vdc for 60 seconds (refer to product specification). Leakage current is less than 1 μ A at nominal input voltage.

24 V dc systems.

The input voltage to the DC/DC converter is SELV (Safety Extra Low Voltage) and the output remains SELV under normal and abnormal operating conditions.

48 and 60 V dc systems.

If the input voltage to Flex DC/DC converter is 75 V dc or less, then the output remains SELV (Safety Extra Low Voltage) under normal and abnormal operating conditions.

Single fault testing in the input power supply circuit should be performed with the DC/DC converter connected to demonstrate that the input voltage does not exceed 75 V dc.

If the input power source circuit is a DC power system, the source may be treated as a TNV2 circuit and testing has demonstrated compliance with SELV limits and isolation requirements equivalent to Basic Insulation in accordance with IEC/EN/UL 60 950.

Non-isolated DC/DC regulators.

The input voltage to the DC/DC regulator is SELV (Safety Extra Low Voltage) and the output remains SELV under normal and abnormal operating conditions.

It is recommended that a slow blow fuse with a rating twice the maximum input current per selected product be used at the input of each DC/DC regulator.

Adjusted to 1.0 Vout - Data

$T_{ref} = -30 \dots +90 \text{ }^\circ\text{C}$, $V_I = 8.3 \dots 16 \text{ V}$ unless otherwise specified. Input filter $4 \times 4.7 \text{ } \mu\text{F}$, Output filter $2 \times 150 \text{ } \mu\text{F}$
 Typ values specified at: $T_{ref} = +25 \text{ }^\circ\text{C}$ and V_{Inom} . $I_{Omax} = 16 \text{ A}$. Note: +Sense connected to +Out. $R_{adj} 41.42 \text{ k}\Omega$

Characteristics		Conditions	Output			Unit
			min	typ	max	
dV_{O_i}	Output voltage adjusted setting	$T_{ref} = +25 \text{ }^\circ\text{C}$, V_{Inom} , I_{Omax}	-2		+2	% V_O
dV_O	Output voltage tolerance band	$I_O = 0.01 \dots 1.0 \times I_{Omax}$	-3		+3	% V_O
dV_O	Idling voltage	$I_O = 0 \text{ A}$	-2		+2	% V_O
dV_O	Line regulation	$V_{Imin} \dots V_{Imax}$, I_{Omax}		2		mV
dV_O	Load regulation	$0.01 \dots 1.0 \times I_{Omax}$, V_{Inom}		25		mV
t_{tr}	Load transient recovery time	Load step = $0.25-0.75-0.25 \times I_{Omax}$, $dl/dt = 5 \text{ A}/\mu\text{s}$, $C_O = 2 \times 150 \text{ } \mu\text{F}$, $V_I = 12 \text{ V}$		40		μs
V_{tr}	Load transient voltage	$V_I = 12 \text{ V}$		± 100		mV
T_{coeff}	Temperature coefficient	$T_{ref} = -30 \dots +90 \text{ }^\circ\text{C}$, I_{Omax}		-0.6		$\text{mV}/^\circ\text{C}$
t_s	Start-up V_I on to $0.9 \times V_O$	$I_O = I_{Omax}$, V_{Inom}		7		ms
t_r	Ramp-up, $V_I \dots 0.9 \times V_O$	$I_O = I_{Omax}$, V_{Inom}		3		ms
t_f	Fall time, V_I to $0.1 \times V_O$	$I_O = I_{Omax}$, V_{Inom}		1		ms
t_f	Fall time, V_I to $0.1 \times V_O$	$I_O = 0 \text{ A}$, V_{Inom}		22		s
t_{RC}	RC shut-down time $0.1 \times V_O$	$I_O = I_{Omax}$, V_{Inom}		1		ms
t_{RC}	RC start-up time $0.9 \times V_O$	$I_O = I_{Omax}$, V_{Inom}		7		ms
t_{RC}	RC fall time, $0.1 \times V_O$	$I_O = 0 \text{ A}$, V_{Inom}		24		s
I_O	Output current		0		16	A
P_{Omax}	Max output power		16			W
I_{lim}	Current limiting threshold	$T_{ref} < T_{refmax}$	19			A
V_{Oac}	Output ripple	20 Hz ... 5 MHz, I_{Omax}		50		mV_{p-p}
η	Efficiency - 50% load	$I_O = 0.5 \times I_{Omax}$, $V_O = 1.00 \text{ V}$		83.6		%
η	Efficiency - 100% load	$I_O = I_{Omax}$, $V_O = 1.00 \text{ V}$	77.3	81.5		%
P_d	Power Dissipation	$I_O = I_{Omax}$, $V_O = 1.00 \text{ V}$		3.6	4.7	W
F_o	Switching frequency	$I_O = (0 \dots 1) \times I_{Omax}$	260	300	340	kHz
I_{sense}	Remote sense current				10	mA
I_I	Static input current $V_I = 8.3 \text{ V}$	$I_O = I_{Omax}$, $V_O = 1.00 \text{ V}$		2.4		A
MTBF	Predicted reliability			5		million hours

Adjusted to 1.0 Vout - Typical Characteristics

General conditions: Input filter 4 x 4.7 μ F, Output filter 2 x 150 μ F

Efficiency

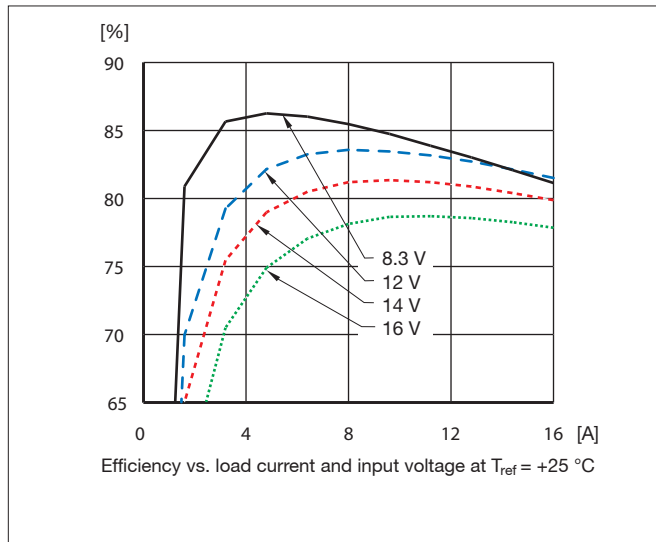

Power Dissipation

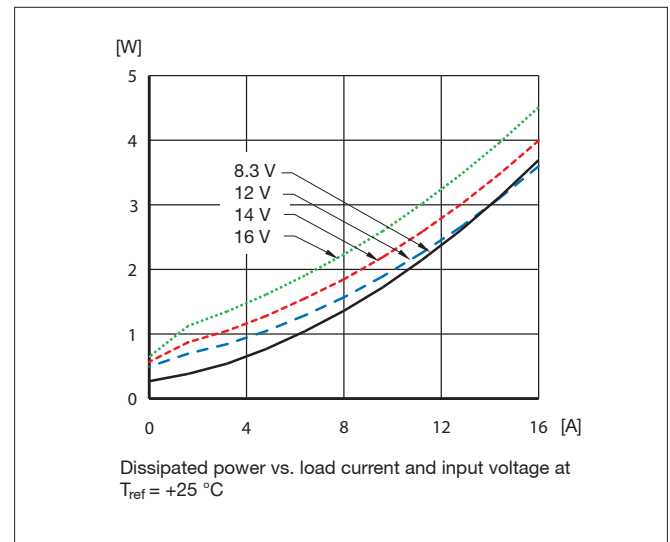

Output Current Derating at 12 V input

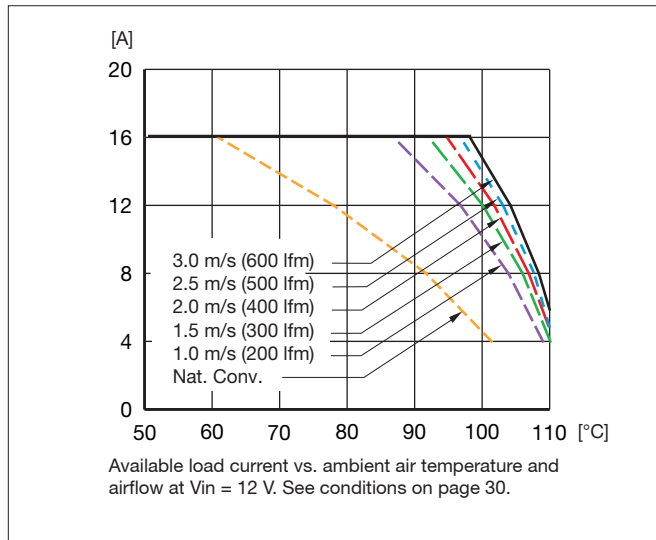

Output Characteristics

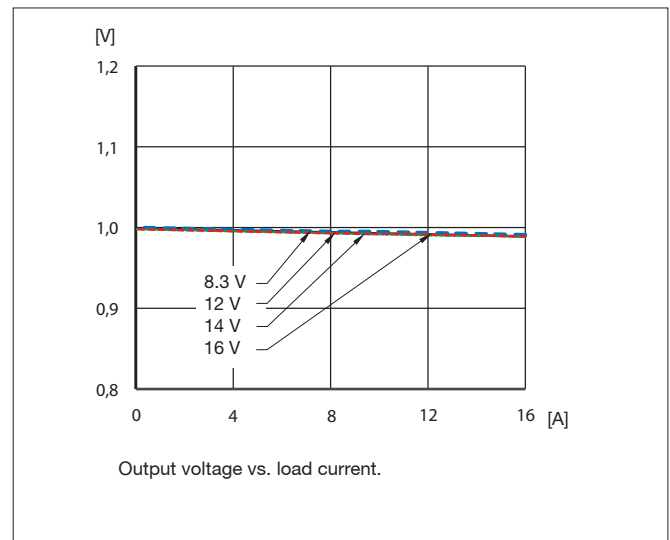

Start-Up

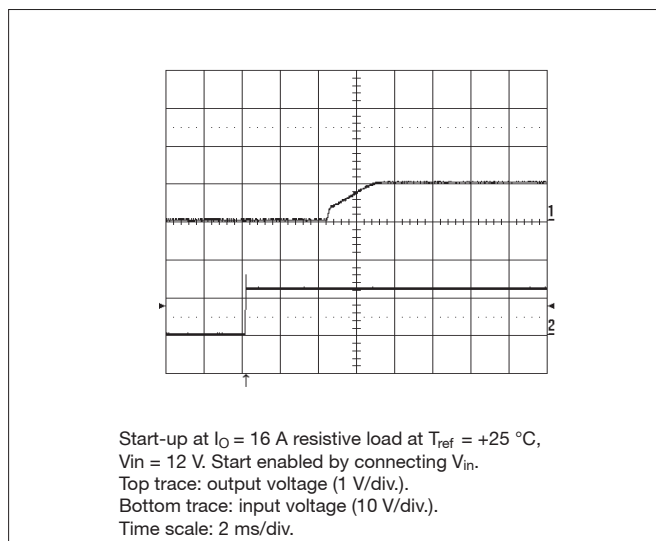

Turn Off

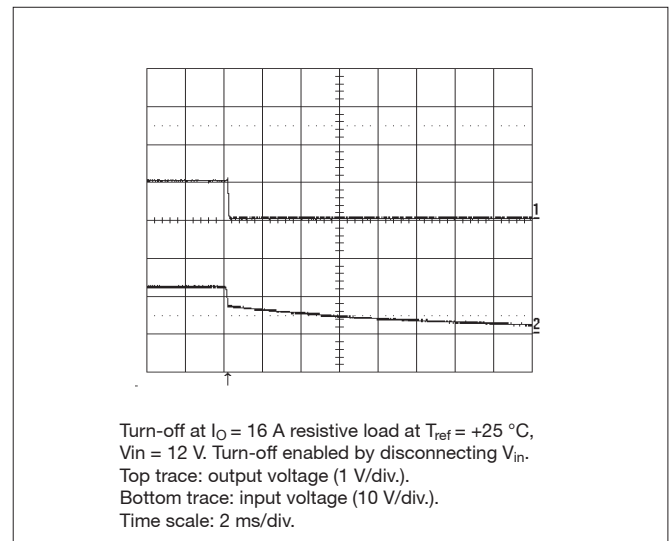

Adjusted to 1.0 Vout - Typical Characteristics

General conditions: Input filter 4 x 4.7 μ F, Output filter 2 x 150 μ F

Output Ripple

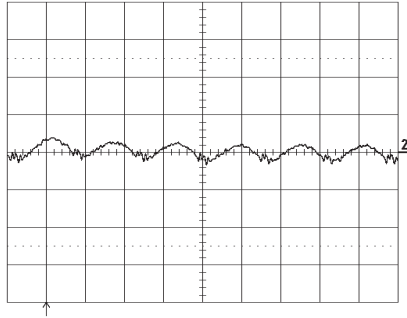

Output voltage ripple (20 mV/div.) at $T_{ref} = +25\text{ }^{\circ}\text{C}$,
 $V_{in} = 12\text{ V}$, $I_O = 16\text{ A}$ resistive load.
Band width = 5 MHz.
Time scale: 2 μ s/div.

Transient

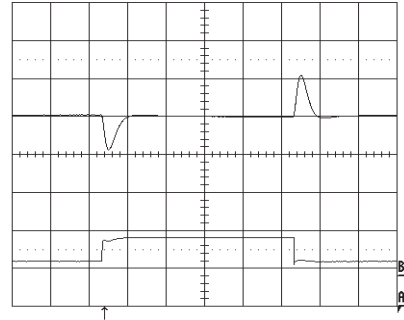

Output voltage response to load current step-change
(4-12-4 A) at $T_{ref} = +25\text{ }^{\circ}\text{C}$, $V_{in} = 12\text{ V}$. $di/dt = 5\text{ A}/\mu\text{s}$
Top trace: output voltage (ac) (100 mV/div.).
Bottom trace: load current (dc) (10 A/div.)
Time scale: 0.1 ms/div.

Adjusted to 1.2 Vout - Data

$T_{ref} = -30 \dots +90 \text{ }^\circ\text{C}$, $V_I = 8.3 \dots 16 \text{ V}$ unless otherwise specified. Input filter $4 \times 4.7 \text{ } \mu\text{F}$, Output filter $2 \times 150 \text{ } \mu\text{F}$
 Typ values specified at: $T_{ref} = +25 \text{ }^\circ\text{C}$ and V_{Inom} , $I_{Omax} = 16 \text{ A}$. Note: +Sense connected to +Out. $R_{adj} 22.46 \text{ k}\Omega$

Characteristics		Conditions	Output			Unit
			min	typ	max	
dV _{Oi}	Output voltage adjusted setting	$T_{ref} = +25 \text{ }^\circ\text{C}$, V_{Inom} , I_{Omax}	-2		+2	% V _O
dV _O	Output voltage tolerance band	$I_O = 0.01 \dots 1.0 \times I_{Omax}$	-3		+3	% V _O
dV _O	Idling voltage	$I_O = 0 \text{ A}$	-2		+2	% V _O
dV _O	Line regulation	$V_{Imin} \dots V_{Imax}$, I_{Omax}		2		mV
dV _O	Load regulation	$0.01 \dots 1.0 \times I_{Omax}$, V_{Inom}		25		mV
t _{tr}	Load transient recovery time	Load step = $0.25-0.75-0.25 \times I_{Omax}$, dI/dt = $5 \text{ A}/\mu\text{s}$, $C_O = 2 \times 150 \text{ } \mu\text{F}$, $V_I = 12 \text{ V}$		40		μs
V _{tr}	Load transient voltage	$V_I = 12 \text{ V}$		± 100		mV
T _{coeff}	Temperature coefficient	$T_{ref} = -30 \dots +90 \text{ }^\circ\text{C}$, I_{Omax}		-0.6		mV/ $^\circ\text{C}$
t _s	Start-up V_I on to $0.9 \times V_O$	$I_O = I_{Omax}$, V_{Inom}		7		ms
t _r	Ramp-up, $V_I \dots 0.9 \times V_O$	$I_O = I_{Omax}$, V_{Inom}		3		ms
t _f	Fall time, V_I to $0.1 \times V_O$	$I_O = I_{Omax}$, V_{Inom}		1		ms
t _f	Fall time, V_I to $0.1 \times V_O$	$I_O = 0 \text{ A}$, V_{Inom}		21		s
t _{RC}	RC shut-down time $0.1 \times V_O$	$I_O = I_{Omax}$, V_{Inom}		1		ms
t _{RC}	RC start-up time $0.9 \times V_O$	$I_O = I_{Omax}$, V_{Inom}		7		ms
t _{RC}	RC fall time, $0.1 \times V_O$	$I_O = 0 \text{ A}$, V_{Inom}		21		s
I _O	Output current		0		16	A
P _{Omax}	Max output power		19.2			W
I _{lim}	Current limiting threshold	$T_{ref} < T_{refmax}$	19			A
V _{Oac}	Output ripple	20 Hz ... 5 MHz, I_{Omax}		50		mV _{p-p}
η	Efficiency - 50% load	$I_O = 0.5 \times I_{Omax}$, $V_O = 1.20 \text{ V}$		85.6		%
η	Efficiency - 100% load	$I_O = I_{Omax}$, $V_O = 1.20 \text{ V}$	80.1	83.9		%
P _d	Power Dissipation	$I_O = I_{Omax}$, $V_O = 1.20 \text{ V}$		3.6	4.7	W
F _o	Switching frequency	$I_O = (0 \dots 1) \times I_{Omax}$	260	300	340	kHz
I _{sense}	Remote sense current				10	mA
I _I	Static input current $V_I = 8.3 \text{ V}$	$I_O = I_{Omax}$, $V_O = 1.20 \text{ V}$		2.8		A
MTBF	Predicted reliability			5		million hours

Adjusted to 1.2 Vout - Typical Characteristics

General conditions: Input filter 4 x 4.7 μF , Output filter 2 x 150 μF

Efficiency

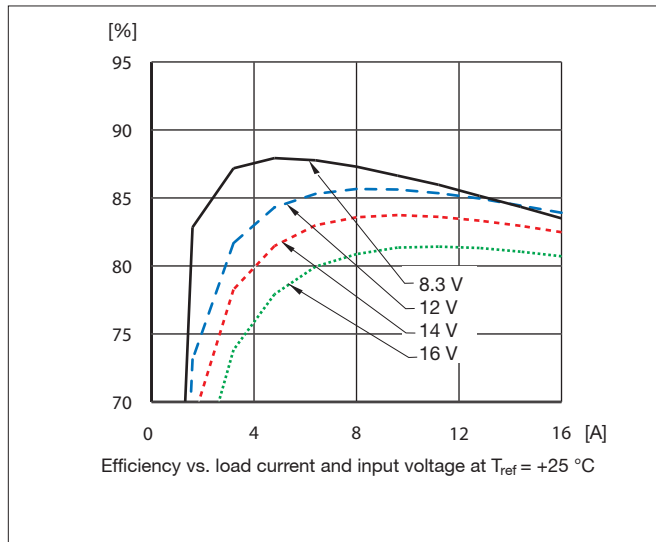

Power Dissipation

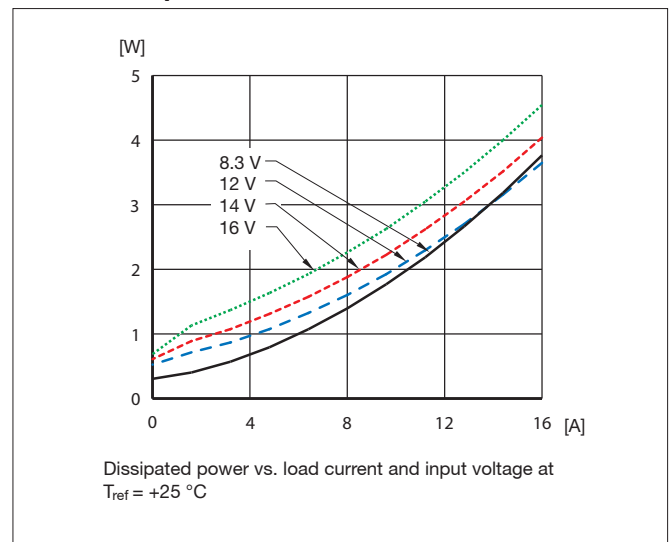

Output Current Derating at 12 V input

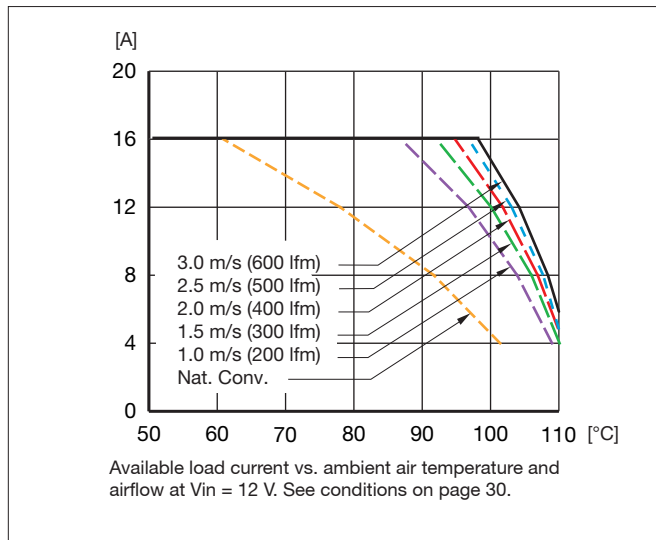

Output Characteristic

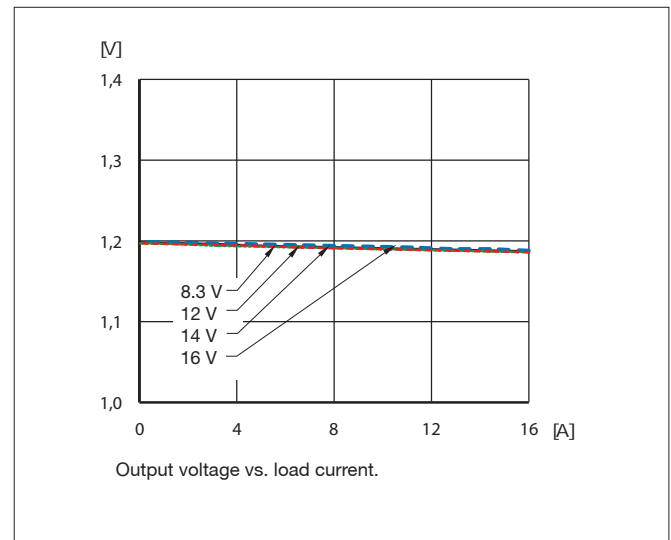

Start-Up

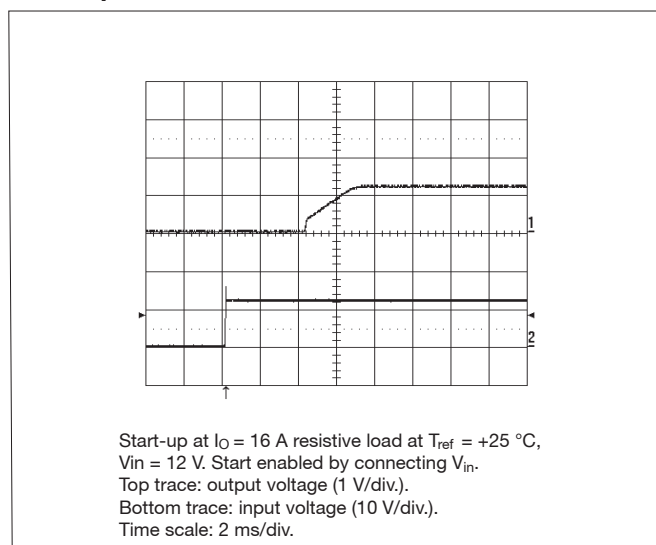

Turn Off

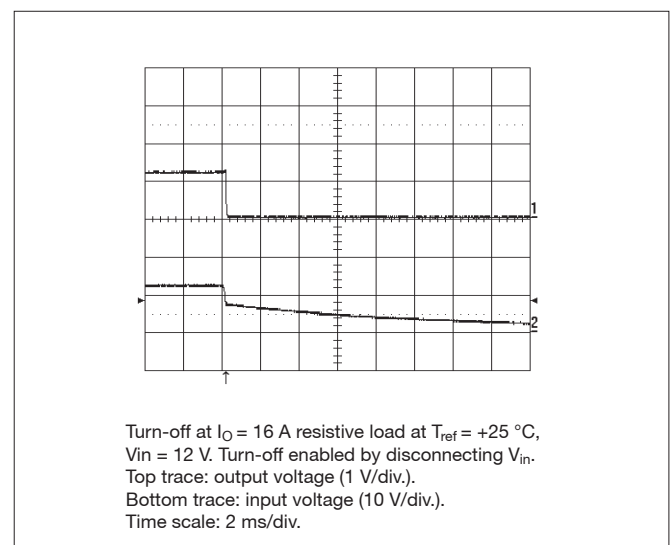

Adjusted to 1.2 Vout - Typical Characteristics

General conditions: Input filter 4 x 4.7 μ F, Output filter 2 x 150 μ F

Output Ripple

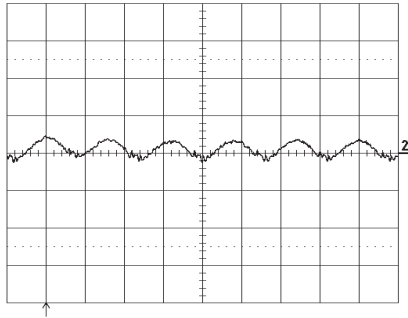

Output voltage ripple (20 mV/div.) at $T_{ref} = +25\text{ }^{\circ}\text{C}$,
 $V_{in} = 12\text{ V}$, $I_O = 16\text{ A}$ resistive load.
Band width = 5 MHz.
Time scale: 2 μ s/div.

Transient

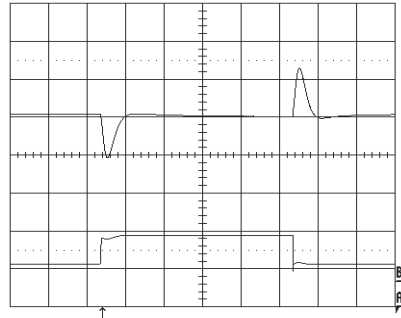

Output voltage response to load current step-change
(4-12-4 A) at $T_{ref} = +25\text{ }^{\circ}\text{C}$, $V_{in} = 12\text{ V}$. $di/dt = 5\text{ A}/\mu\text{s}$
Top trace: output voltage (ac) (100 mV/div.).
Bottom trace: load current (dc) (10 A/div.)
Time scale: 0.1 ms/div.

Adjusted to 1.5 Vout - Data

$T_{ref} = -30 \dots +90 \text{ }^\circ\text{C}$, $V_I = 8.3 \dots 16 \text{ V}$ unless otherwise specified. Input filter $4 \times 4.7 \text{ } \mu\text{F}$, Output filter $2 \times 150 \text{ } \mu\text{F}$
Typ values specified at: $T_{ref} = +25 \text{ }^\circ\text{C}$ and V_{Inom} . $I_{Omax} = 16 \text{ A}$. Note: +Sense connected to +Out. $R_{adj} 13.05 \text{ k}\Omega$

Characteristics		Conditions	Output			Unit
			min	typ	max	
dV _{Oi}	Output voltage adjusted setting	$T_{ref} = +25 \text{ }^\circ\text{C}$, V_{Inom} , I_{Omax}	-2		+2	% V _O
dV _O	Output voltage tolerance band	$I_O = 0.01 \dots 1.0 \times I_{Omax}$	-3		+3	% V _O
dV _O	Idling voltage	$I_O = 0 \text{ A}$	-2		+2	% V _O
dV _O	Line regulation	$V_{Imin} \dots V_{Imax}$, I_{Omax}		2		mV
dV _O	Load regulation	$0.01 \dots 1.0 \times I_{Omax}$, V_{Inom}		25		mV
t _{tr}	Load transient recovery time	Load step = $0.25-0.75-0.25 \times I_{Omax}$, $di/dt = 5 \text{ A}/\mu\text{s}$, $C_O = 2 \times 150 \text{ } \mu\text{F}$, $V_I = 12 \text{ V}$		40		μs
V _{tr}	Load transient voltage	$V_I = 12 \text{ V}$		± 100		mV
T _{coeff}	Temperature coefficient	$T_{ref} = -30 \dots +90 \text{ }^\circ\text{C}$, I_{Omax}		-0.6		mV/ $^\circ\text{C}$
t _s	Start-up V_I on to $0.9 \times V_O$	$I_O = I_{Omax}$, V_{Inom}		7		ms
t _r	Ramp-up, $V_I \dots 0.9 \times V_O$	$I_O = I_{Omax}$, V_{Inom}		3		ms
t _f	Fall time, V_I to $0.1 \times V_O$	$I_O = I_{Omax}$, V_{Inom}		1		ms
t _f	Fall time, V_I to $0.1 \times V_O$	$I_O = 0 \text{ A}$, V_{Inom}		20		s
t _{RC}	RC shut-down time $0.1 \times V_O$	$I_O = I_{Omax}$, V_{Inom}		1		ms
t _{RC}	RC start-up time $0.9 \times V_O$	$I_O = I_{Omax}$, V_{Inom}		7		ms
t _{RC}	RC fall time, $0.1 \times V_O$	$I_O = 0 \text{ A}$, V_{Inom}		20		s
I _O	Output current		0		16	A
P _{Omax}	Max output power		24			W
I _{lim}	Current limiting threshold	$T_{ref} < T_{refmax}$	19			A
V _{Oac}	Output ripple	20 Hz ... 5 MHz, I_{Omax}		50		mV _{p-p}
η	Efficiency - 50% load	$I_O = 0.5 \times I_{Omax}$, $V_O = 1.50 \text{ V}$		87.7		%
η	Efficiency - 100% load	$I_O = I_{Omax}$, $V_O = 1.50 \text{ V}$	82.9	86.3		%
P _d	Power Dissipation	$I_O = I_{Omax}$, $V_O = 1.50 \text{ V}$		3.8	4.9	W
F _o	Switching frequency	$I_O = (0 \dots 1) \times I_{Omax}$	260	300	340	kHz
I _{sense}	Remote sense current				10	mA
I _I	Static input current $V_I = 8.3 \text{ V}$	$I_O = I_{Omax}$, $V_O = 1.50 \text{ V}$		3.4		A
MTBF	Predicted reliability			5		million hours

Adjusted to 1.5 Vout - Typical Characteristics

General conditions: Input filter 4 x 4.7 μ F, Output filter 2 x 150 μ F

Efficiency

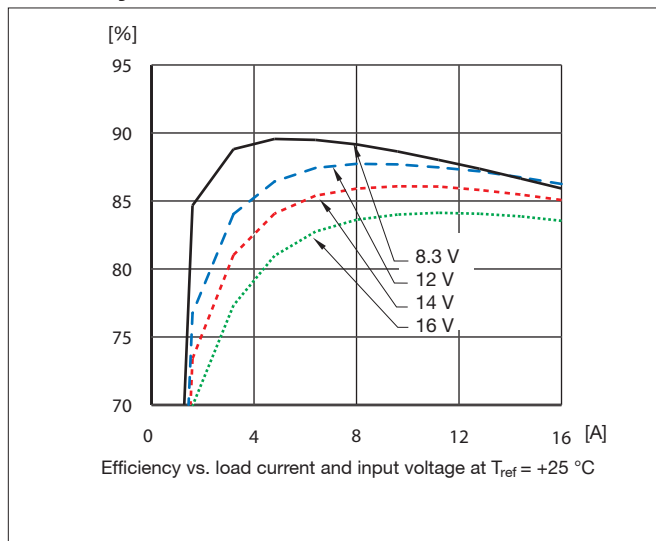

Power Dissipation

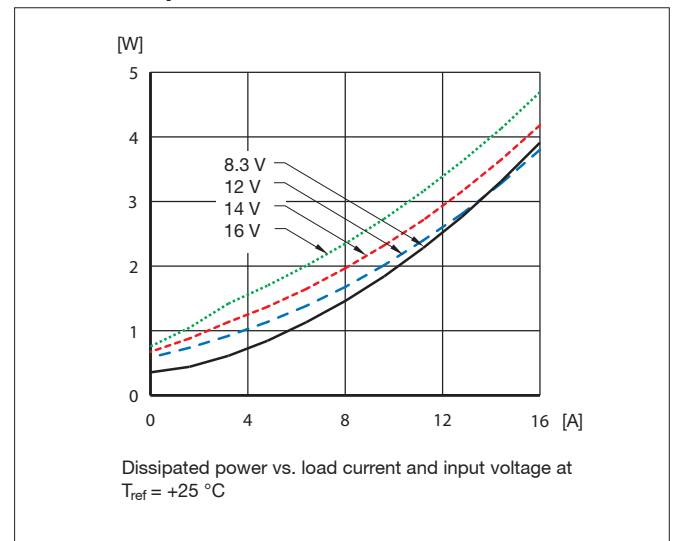

Output Current Derating at 12 V input

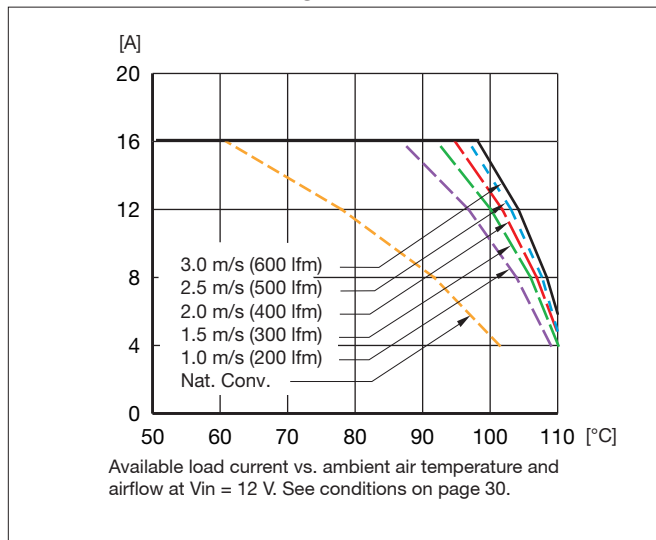

Output Characteristic

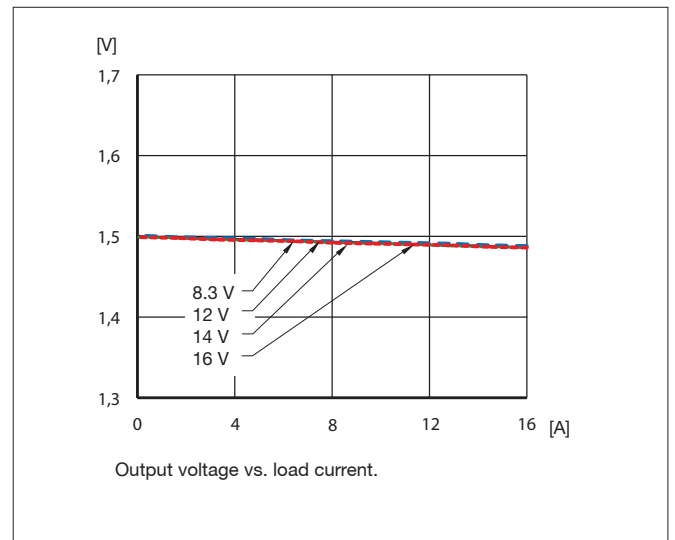

Start-Up

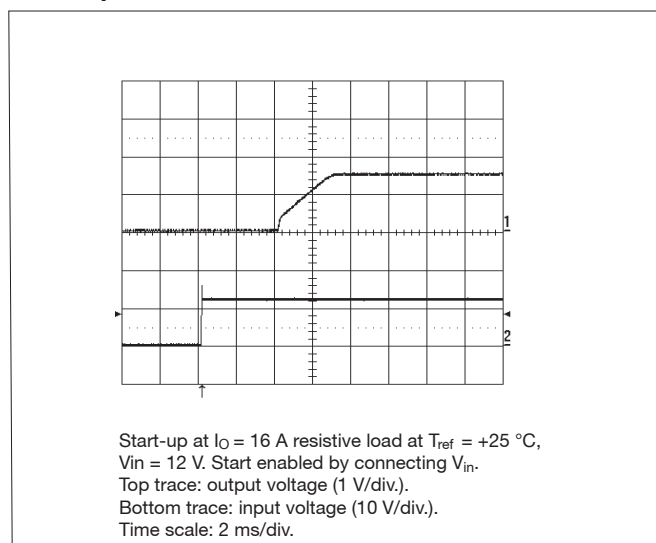

Turn Off

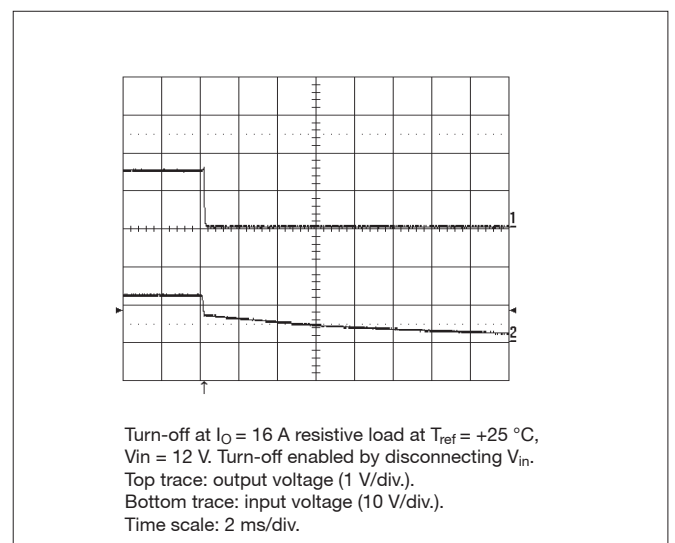

Adjusted to 1.5 Vout - Typical Characteristics

General conditions: Input filter 4 x 4.7 μ F, Output filter 2 x 150 μ F

Output Ripple

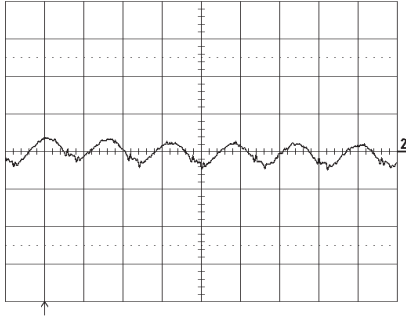

Output voltage ripple (20 mV/div.) at $T_{ref} = +25\text{ }^{\circ}\text{C}$,
 $V_{in} = 12\text{ V}$, $I_O = 16\text{ A}$ resistive load.
Band width = 5 MHz.
Time scale: 2 μ s/div.

Transient

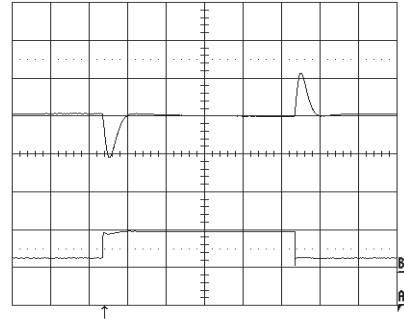

Output voltage response to load current step-change
(4-12-4 A) at $T_{ref} = +25\text{ }^{\circ}\text{C}$, $V_{in} = 12\text{ V}$. $dI/dt = 5\text{ A}/\mu\text{s}$
Top trace: output voltage (ac) (100 mV/div.).
Bottom trace: load current (dc) (10 A/div.)
Time scale: 0.1 ms/div.

Adjusted to 1.8 Vout - Data

$T_{ref} = -30...+90\text{ °C}$, $V_I = 8.3 \dots 16\text{ V}$ unless otherwise specified. Input filter $4 \times 4.7\ \mu\text{F}$, Output filter $2 \times 150\ \mu\text{F}$
 Typ values specified at: $T_{ref} = +25\text{ °C}$ and V_{Inom} . $I_{Omax} = 16\text{ A}$. Note: +Sense connected to +Out. $R_{adj} 9.024\text{ k}\Omega$

Characteristics		Conditions	Output			Unit
			min	typ	max	
dV _{Oi}	Output voltage adjusted setting	$T_{ref} = +25\text{ °C}$, V_{Inom} , I_{Omax}	-2		+2	% V _O
dV _O	Output voltage tolerance band	$I_O = 0.01...1.0 \times I_{Omax}$	-3		+3	% V _O
dV _O	Idling voltage	$I_O = 0\text{ A}$	-2		+2	% V _O
dV _O	Line regulation	$V_{Imin} \dots V_{Imax}$, I_{Omax}		2		mV
dV _O	Load regulation	$0.01...1.0 \times I_{Omax}$, V_{Inom}		25		mV
t _{tr}	Load transient recovery time	Load step = $0.25-0.75-0.25 \times I_{Omax}$, dI/dt = $5\text{ A}/\mu\text{s}$, $C_O = 2 \times 150\ \mu\text{F}$, $V_I = 12\text{ V}$		40		μs
V _{tr}	Load transient voltage	$V_I = 12\text{ V}$		± 100		mV
T _{coeff}	Temperature coefficient	$T_{ref} = -30 \dots +90\text{ °C}$, I_{Omax}		-0.6		mV/°C
t _s	Start-up V _I on to $0.9 \times V_O$	$I_O = I_{Omax}$, V_{Inom}		7		ms
t _r	Ramp-up, V _I ... $0.9 \times V_O$	$I_O = I_{Omax}$, V_{Inom}		3		ms
t _f	Fall time, V _I to $0.1 \times V_O$	$I_O = I_{Omax}$, V_{Inom}		1		ms
t _f	Fall time, V _I to $0.1 \times V_O$	$I_O = 0\text{ A}$, V_{Inom}		18		s
t _{RC}	RC shut-down time $0.1 \times V_O$	$I_O = I_{Omax}$, V_{Inom}		1		ms
t _{RC}	RC start-up time $0.9 \times V_O$	$I_O = I_{Omax}$, V_{Inom}		7		ms
t _{RC}	RC fall time, $0.1 \times V_O$	$I_O = 0\text{ A}$, V_{Inom}		18		s
I _O	Output current		0		16	A
P _{Omax}	Max output power		28.8			W
I _{lim}	Current limiting threshold	$T_{ref} < T_{refmax}$	19			A
V _{Oac}	Output ripple	20 Hz ... 5 MHz, I_{Omax}		50		mV _{p-p}
η	Efficiency - 50% load	$I_O = 0.5 \times I_{Omax}$, $V_O = 1.80\text{ V}$		89.2		%
η	Efficiency - 100% load	$I_O = I_{Omax}$, $V_O = 1.80\text{ V}$	85.0	88.1		%
P _d	Power Dissipation	$I_O = I_{Omax}$, $V_O = 1.80\text{ V}$		3.9	5.1	W
F _o	Switching frequency	$I_O = (0... 1) \times I_{Omax}$	260	300	340	kHz
I _{sense}	Remote sense current				10	mA
I _I	Static input current V _I = 8.3 V	$I_O = I_{Omax}$, $V_O = 1.80\text{ V}$		4.0		A
MTBF	Predicted reliability			5		million hours

Adjusted to 1.8 Vout - Typical Characteristics

General conditions: Input filter 4 x 4.7 μ F, Output filter 2 x 150 μ F

Efficiency

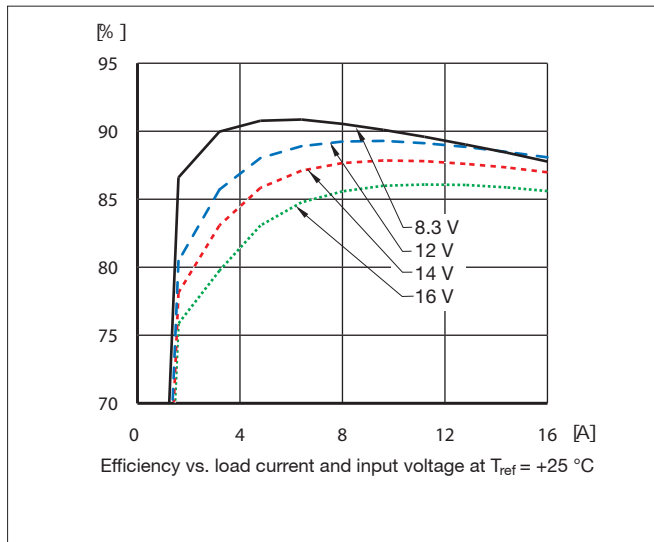

Power Dissipation

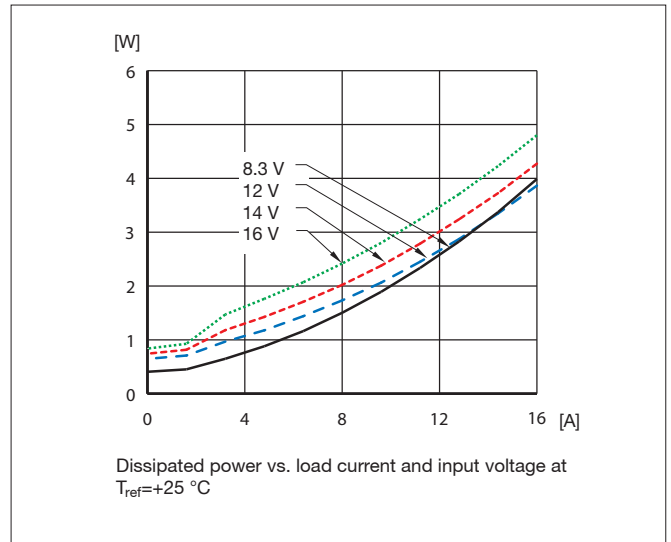

Output Current Derating at 12 V input

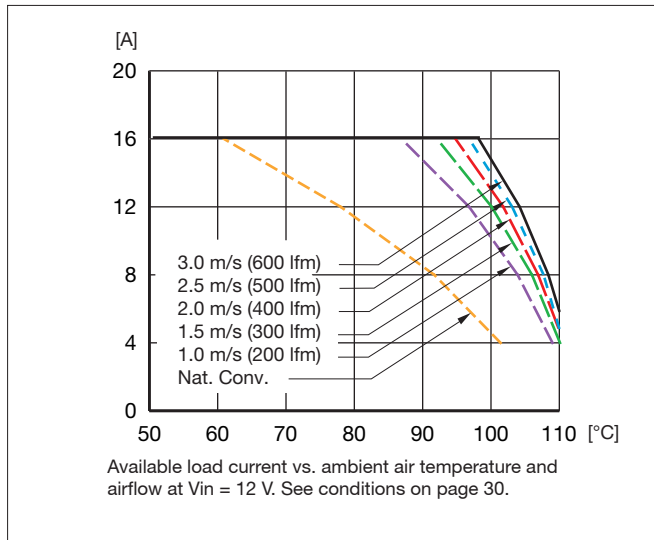

Output Characteristic

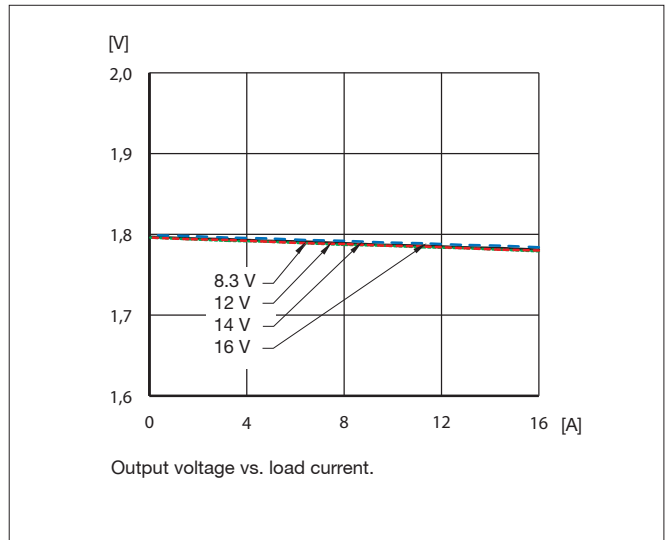

Start-Up

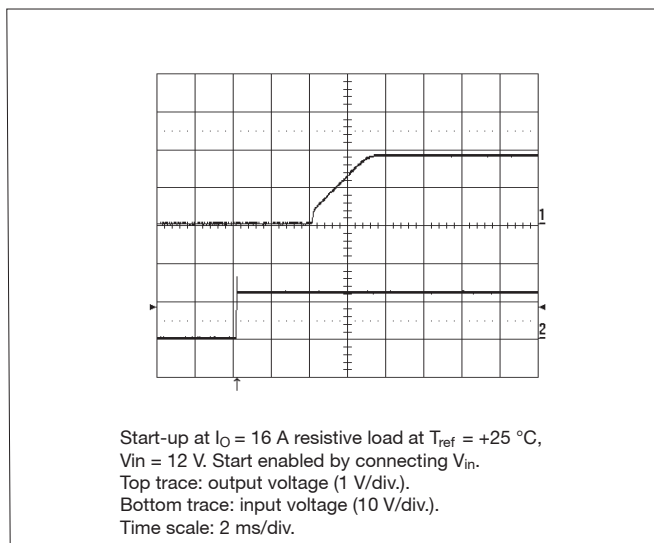

Turn Off

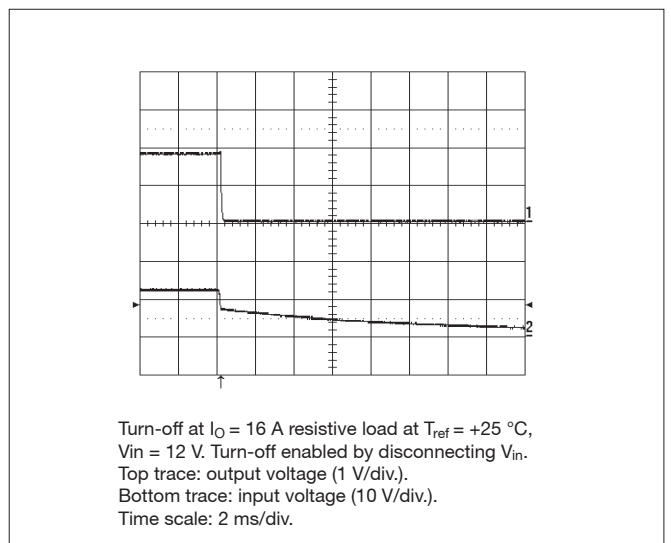

Adjusted to 1.8 Vout - Typical Characteristics

General conditions: Input filter 4 x 4.7 μ F, Output filter 2 x 150 μ F

Output Ripple

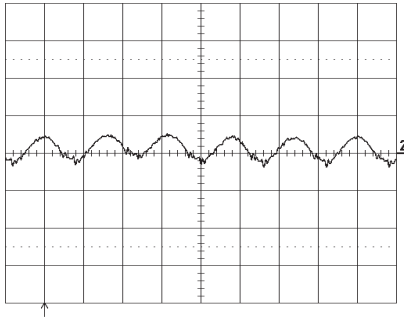

Output voltage ripple (20 mV/div.) at $T_{ref} = +25\text{ }^{\circ}\text{C}$,
 $V_{in} = 12\text{ V}$, $I_O = 16\text{ A}$ resistive load.
Band width = 5 MHz.
Time scale: 2 μ s/div.

Transient

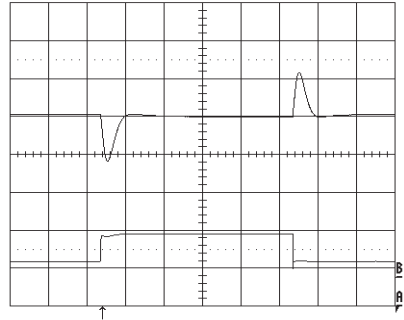

Output voltage response to load current step-change
(4-12-4 A) at $T_{ref} = +25\text{ }^{\circ}\text{C}$, $V_{in} = 12\text{ V}$. $di/dt = 5\text{ A}/\mu\text{s}$
Top trace: output voltage (ac) (100 mV/div).
Bottom trace: load current (dc) (10 A/div.)
Time scale: 0.1 ms/div.

Adjusted to 2.5 Vout - Data

$T_{ref} = -30 \dots +90 \text{ }^\circ\text{C}$, $V_I = 8.3 \dots 16 \text{ V}$ unless otherwise specified. Input filter $4 \times 4.7 \text{ } \mu\text{F}$, Output filter $2 \times 150 \text{ } \mu\text{F}$
 Typ values specified at: $T_{ref} = +25 \text{ }^\circ\text{C}$ and V_{Inom} . $I_{Omax} = 16 \text{ A}$. Note: +Sense connected to +Out. $R_{adj} 5.009 \text{ k}\Omega$

Characteristics		Conditions	Output			Unit
			min	typ	max	
dV _{Oi}	Output voltage adjusted setting	$T_{ref} = +25 \text{ }^\circ\text{C}$, V_{Inom} , I_{Omax}	-2		+2	% V _O
dV _O	Output voltage tolerance band	$I_O = 0.01 \dots 1.0 \times I_{Omax}$	-3		+3	% V _O
dV _O	Idling voltage	$I_O = 0 \text{ A}$	-2		+2	% V _O
dV _O	Line regulation	$V_{Imin} \dots V_{Imax}$, I_{Omax}		6		mV
dV _O	Load regulation	$0.01 \dots 1.0 \times I_{Omax}$, V_{Inom}		25		mV
t _{tr}	Load transient recovery time	Load step = $0.25-0.75-0.25 \times I_{Omax}$, dI/dt = $5 \text{ A}/\mu\text{s}$, $C_O = 2 \times 150 \text{ } \mu\text{F}$, $V_I = 12 \text{ V}$		40		μs
V _{tr}	Load transient voltage	$V_I = 12 \text{ V}$		± 150		mV
T _{coeff}	Temperature coefficient	$T_{ref} = -30 \dots +90 \text{ }^\circ\text{C}$, I_{Omax}		-0.6		mV/ $^\circ\text{C}$
t _s	Start-up V _I on to $0.9 \times V_O$	$I_O = I_{Omax}$, V_{Inom}		7		ms
t _r	Ramp-up, V _I ... $0.9 \times V_O$	$I_O = I_{Omax}$, V_{Inom}		3		ms
t _f	Fall time, V _I to $0.1 \times V_O$	$I_O = I_{Omax}$, V_{Inom}		1		ms
t _f	Fall time, V _I to $0.1 \times V_O$	$I_O = 0 \text{ A}$, V_{Inom}		16		s
t _{RC}	RC shut-down time $0.1 \times V_O$	$I_O = I_{Omax}$, V_{Inom}		1		ms
t _{RC}	RC start-up time $0.9 \times V_O$	$I_O = I_{Omax}$, V_{Inom}		7		ms
t _{RC}	RC fall time, $0.1 \times V_O$	$I_O = 0 \text{ A}$, V_{Inom}		16		s
I _O	Output current		0		16	A
P _{Omax}	Max output power		40			W
I _{lim}	Current limiting threshold	$T_{ref} < T_{refmax}$	19			A
V _{Oac}	Output ripple	20 Hz ... 5 MHz, I_{Omax}		50		mV _{p-p}
η	Efficiency - 50% load	$I_O = 0.5 \times I_{Omax}$, $V_O = 2.50 \text{ V}$		91.4		%
η	Efficiency - 100% load	$I_O = I_{Omax}$, $V_O = 2.50 \text{ V}$	88.1	90.6		%
P _d	Power Dissipation	$I_O = I_{Omax}$, $V_O = 2.50 \text{ V}$		4.1	5.4	W
F _o	Switching frequency	$I_O = (0 \dots 1) \times I_{Omax}$	260	300	340	kHz
I _{sense}	Remote sense current				10	mA
I _I	Static input current V _I = 8.3 V	$I_O = I_{Omax}$, $V_O = 2.50 \text{ V}$		5.3		A
MTBF	Predicted reliability			5		million hours

Adjusted to 2.5 Vout - Typical Characteristics

General conditions: Input filter 4 x 4.7 μF , Output filter 2 x 150 μF

Efficiency

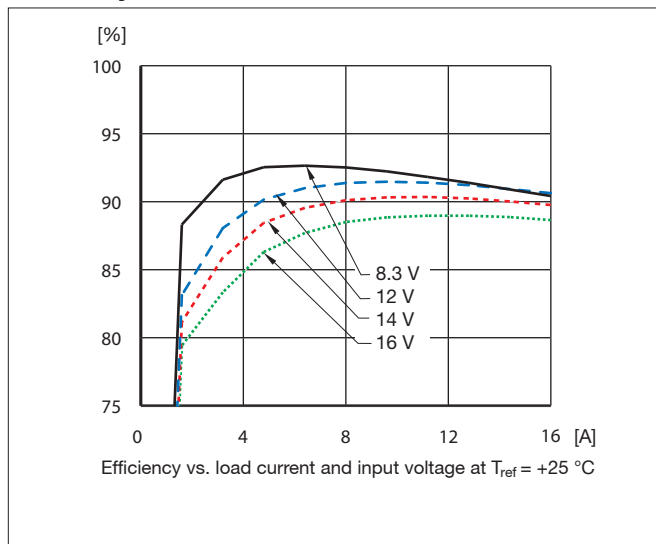

Power Dissipation

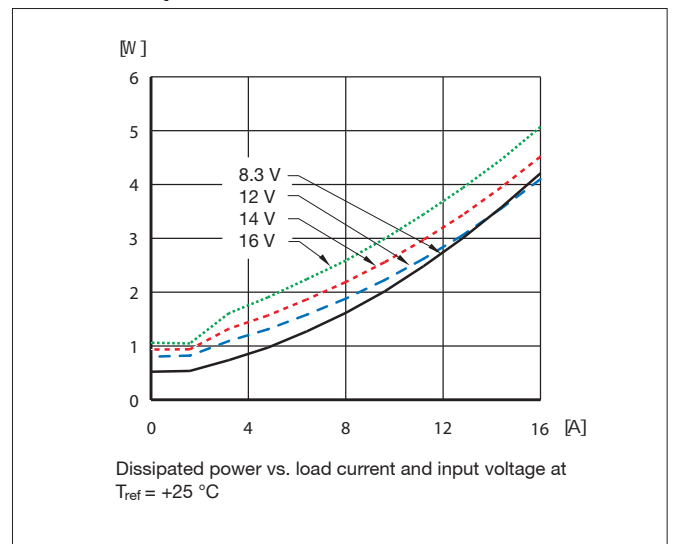

Output Current Derating at 12 V input

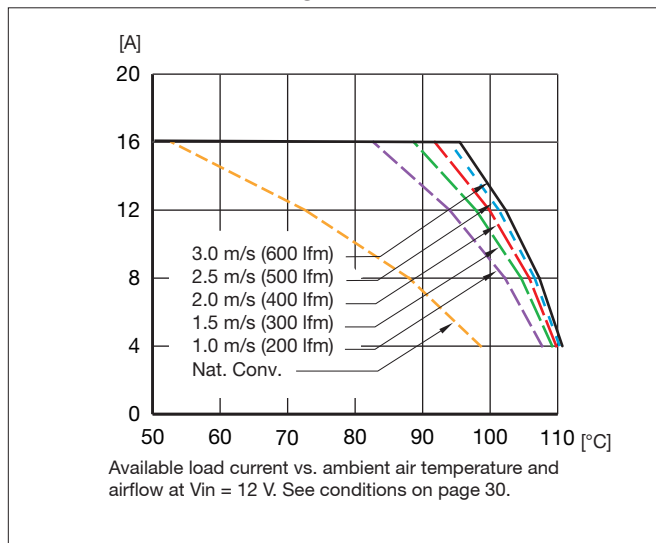

Output Characteristic

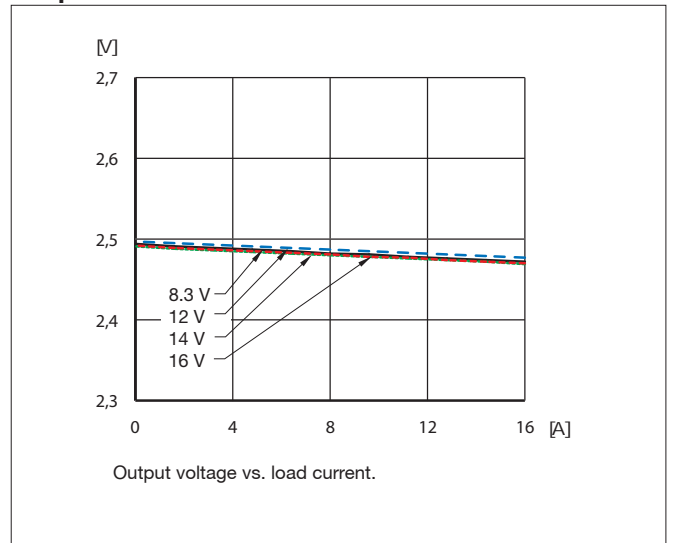

Start-Up

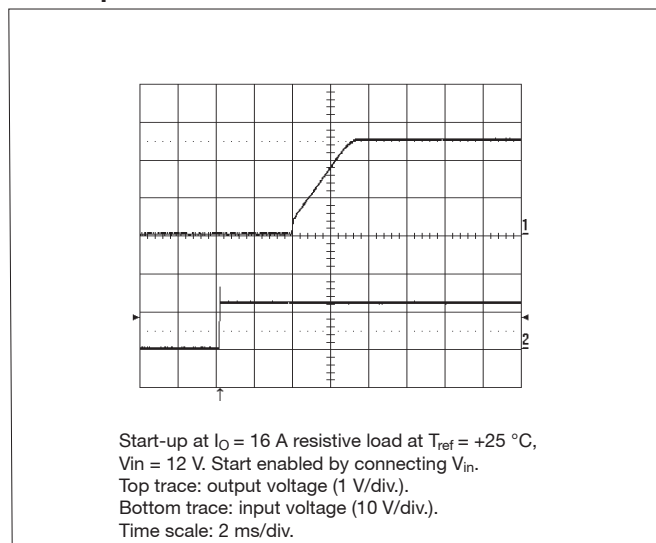

Turn Off

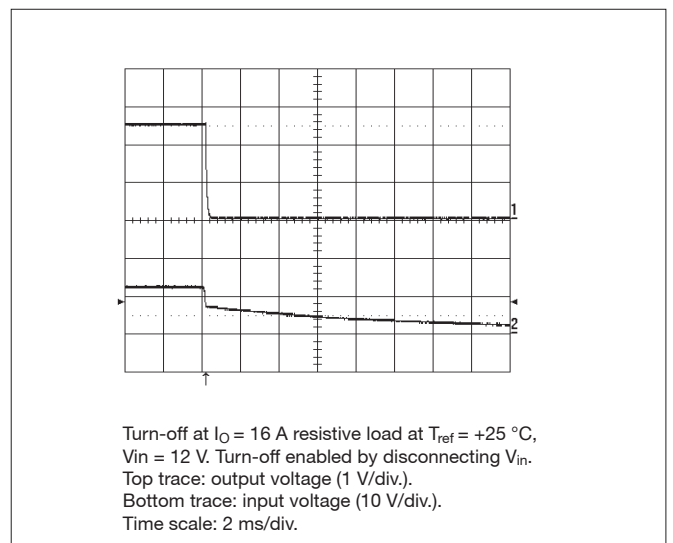

Adjusted to 2.5 Vout - Typical Characteristics

General conditions: Input filter 4 x 4.7 μ F, Output filter 2 x 150 μ F

Output Ripple

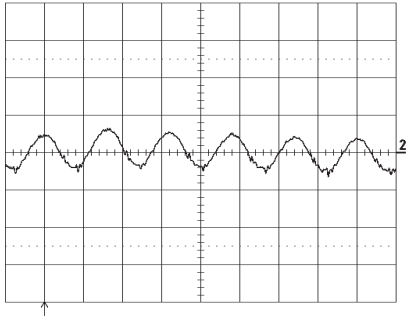

Output voltage ripple (20 mV/div.) at $T_{ref} = +25\text{ }^{\circ}\text{C}$,
 $V_{in} = 12\text{ V}$, $I_O = 16\text{ A}$ resistive load.
Band width = 5 MHz.
Time scale: 2 μ s/div.

Transient

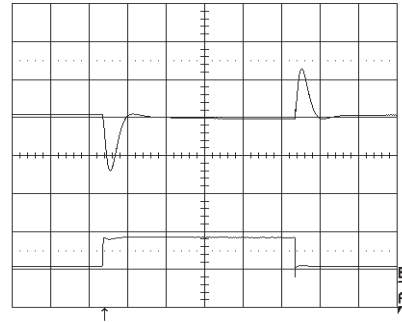

Output voltage response to load current step-change
(4-12-4 A) at $T_{ref} = +25\text{ }^{\circ}\text{C}$, $V_{in} = 12\text{ V}$. $di/dt = 5\text{ A}/\mu\text{s}$
Top trace: output voltage (ac) (100 mV/div.).
Bottom trace: load current (dc) (10 A/div.)
Time scale: 0.1 ms/div.

Adjusted to 3.3 Vout - Data

$T_{ref} = -30 \dots +90 \text{ }^\circ\text{C}$, $V_I = 8.3 \dots 16 \text{ V}$ unless otherwise specified. Input filter $4 \times 4.7 \text{ } \mu\text{F}$, Output filter $2 \times 150 \text{ } \mu\text{F}$
 Typ values specified at: $T_{ref} = +25 \text{ }^\circ\text{C}$ and V_{Inom} . $I_{Omax} = 16 \text{ A}$. Note: +Sense connected to +Out. $R_{adj} 3.122 \text{ k}\Omega$

Characteristics		Conditions	Output			Unit
			min	typ	max	
dV_{O_i}	Output voltage adjusted setting	$T_{ref} = +25 \text{ }^\circ\text{C}$, V_{Inom} , I_{Omax}	-2		+2	% V_O
dV_O	Output voltage tolerance band	$I_O = 0.01 \dots 1.0 \times I_{Omax}$	-3		+3	% V_O
dV_O	Idling voltage	$I_O = 0 \text{ A}$	-2		+2	% V_O
dV_O	Line regulation	$V_{Imin} \dots V_{Imax}$, I_{Omax}		6		mV
dV_O	Load regulation	$I_O = 0.01 \dots I_{Omax}$, V_{Inom}		25		mV
t_{tr}	Load transient recovery time	Load step = $0.25-0.75-0.25 \times I_{Omax}$, $dI/dt = 5 \text{ A}/\mu\text{s}$, $C_O = 2 \times 150 \text{ } \mu\text{F}$, $V_I = 12 \text{ V}$		40		μs
V_{tr}	Load transient voltage			± 150		mV
T_{coeff}	Temperature coefficient	$T_{ref} = -30 \dots +90 \text{ }^\circ\text{C}$, I_{Omax}		-0.6		$\text{mV}/^\circ\text{C}$
t_s	Start-up V_I on to $0.9 \times V_O$	$I_O = I_{Omax}$, V_{Inom}		7		ms
t_r	Ramp-up, $V_I \dots 0.9 \times V_O$	$I_O = I_{Omax}$, V_{Inom}		3		ms
t_f	Fall time, V_I to $0.1 \times V_O$	$I_O = I_{Omax}$, V_{Inom}		1		ms
t_f	Fall time, V_I to $0.1 \times V_O$	$I_O = 0 \text{ A}$, V_{Inom}		17		s
t_{RC}	RC shut-down time $0.1 \times V_O$	$I_O = I_{Omax}$, V_{Inom}		1		ms
t_{RC}	RC start-up time $0.9 \times V_O$	$I_O = I_{Omax}$, V_{Inom}		7		ms
t_{RC}	RC fall time, $0.1 \times V_O$	$I_O = 0 \text{ A}$, V_{Inom}		17		s
I_O	Output current		0		16	A
P_{Omax}	Max output power		52.8			W
I_{lim}	Current limiting threshold	$T_{ref} < T_{refmax}$	19			A
V_{Oac}	Output ripple	20 Hz ... 5 MHz, I_{Omax}		50		mV_{p-p}
η	Efficiency - 50% load	$I_O = 0.5 \times I_{Omax}$, $V_O = 3.30 \text{ V}$		92.8		%
η	Efficiency - 100% load	$I_O = I_{Omax}$, $V_O = 3.30 \text{ V}$	90.1	92.3		%
P_d	Power Dissipation	$I_O = I_{Omax}$, $V_O = 3.30 \text{ V}$		4.3	5.8	W
F_o	Switching frequency	$I_O = (0 \dots 1) \times I_{Omax}$	260	300	340	kHz
I_{sense}	Remote sense current				10	mA
I_I	Static input current $V_I = 8.3 \text{ V}$	$I_O = I_{Omax}$, $V_O = 3.30 \text{ V}$		6.9		A
MTBF	Predicted reliability			5		million hours

Adjusted to 3.3 Vout - Typical Characteristics

General conditions: Input filter 4 x 4.7 μ F, Output filter 2 x 150 μ F

Efficiency

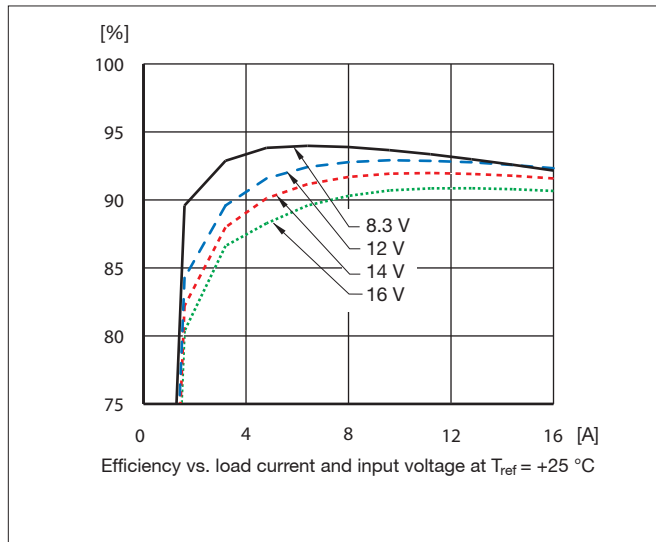

Power Dissipation

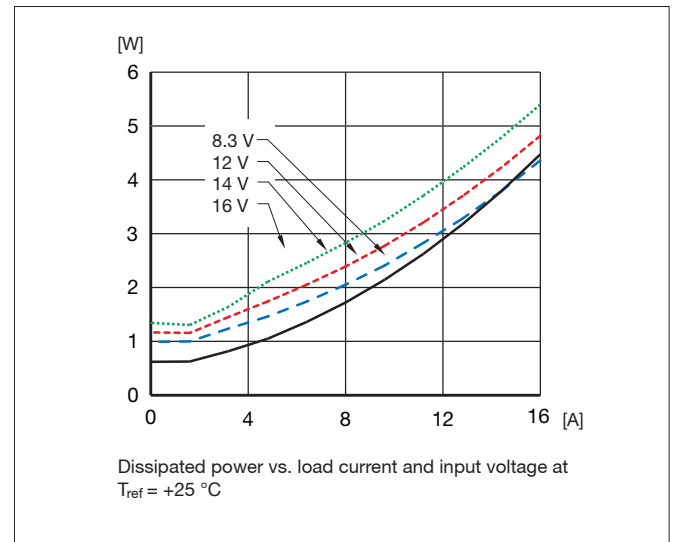

Output Current Derating at 12 V input

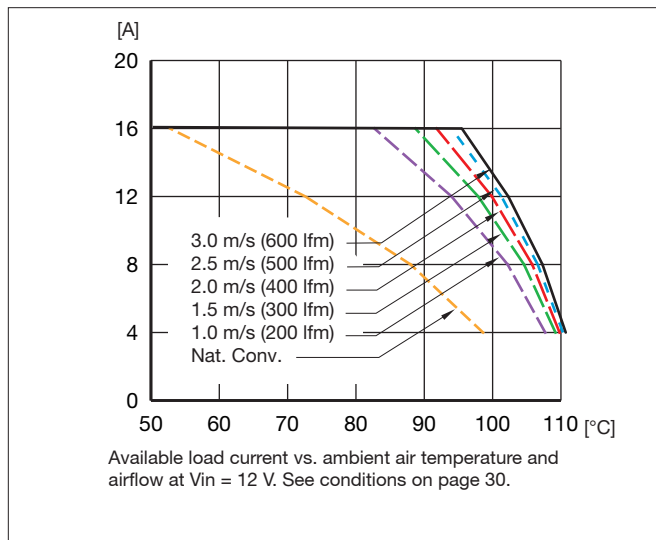

Output Characteristic

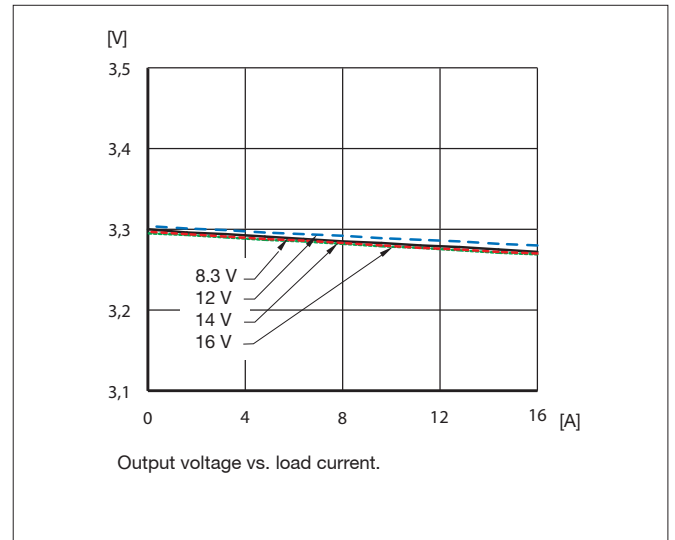

Start-Up

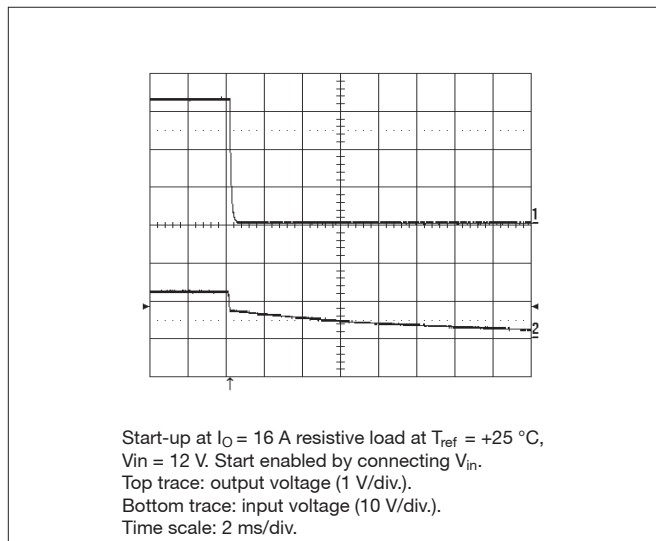

Turn Off

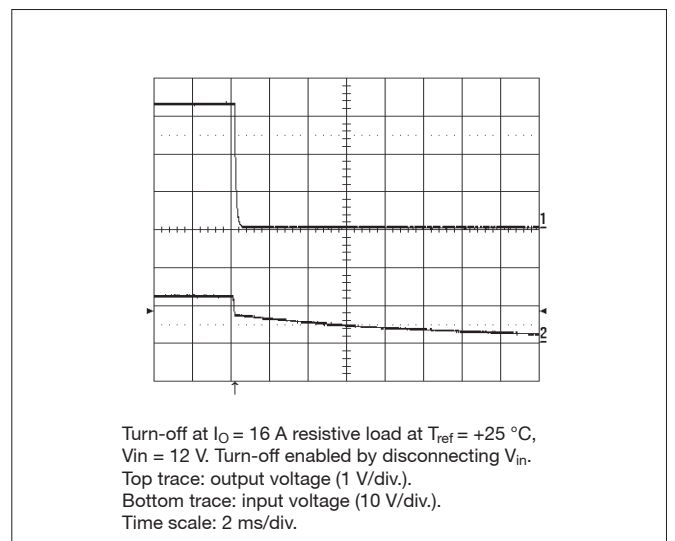

Adjusted to 3.3 Vout - Typical Characteristics

General conditions: Input filter 4 x 4.7 μ F, Output filter 2 x 150 μ F

Output Ripple

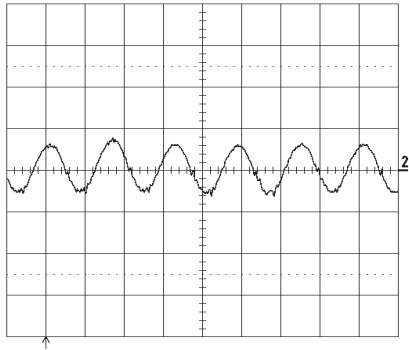

Output voltage ripple (20 mV/div.) at $T_{ref} = +25\text{ }^{\circ}\text{C}$,
 $V_{in} = 12\text{ V}$, $I_O = 16\text{ A}$ resistive load.
Band width = 5 MHz.
Time scale: 2 μ s/div.

Transient

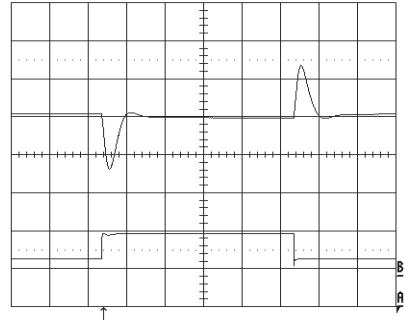

Output voltage response to load current step-change
(4-12-4 A) at $T_{ref} = +25\text{ }^{\circ}\text{C}$, $V_{in} = 12\text{ V}$. $di/dt = 5\text{ A}/\mu\text{s}$
Top trace: output voltage (ac) (100 mV/div.).
Bottom trace: load current (dc) (10 A/div.)
Time scale: 0.1 ms/div.

Adjusted to 5.0 Vout - Data

$T_{ref} = -30 \dots +90 \text{ }^\circ\text{C}$, $V_I = 8.3 \dots 16 \text{ V}$ unless otherwise specified. Input filter $4 \times 4.7 \text{ } \mu\text{F}$, Output filter $2 \times 150 \text{ } \mu\text{F}$
 Typ values specified at: $T_{ref} = +25 \text{ }^\circ\text{C}$ and V_{Inom} . $I_{Omax} = 16 \text{ A}$. Note: +Sense connected to +Out. $R_{adj} 1.472 \text{ k}\Omega$

Characteristics		Conditions	Output			Unit
			min	typ	max	
dV _{Oi}	Output voltage adjusted setting	$T_{ref} = +25 \text{ }^\circ\text{C}$, V_{Inom} , I_{Omax}	-2		+2	% V _O
dV _O	Output voltage tolerance band	$I_O = 0.01 \dots 1.0 \times I_{Omax}$	-3		+3	% V _O
dV _O	Idling voltage	$I_O = 0 \text{ A}$	-2		+2	% V _O
dV _O	Line regulation	$V_{Imin} \dots V_{Imax}$, I_{Omax}		12		mV
dV _O	Load regulation	$0.01 \dots 1.0 \times I_{Omax}$, V_{Inom}		25		mV
t _{tr}	Load transient recovery time	Load step = $0.25-0.75-0.25 \times I_{Omax}$, dI/dt = $5 \text{ A}/\mu\text{s}$, $C_O = 2 \times 150 \text{ } \mu\text{F}$, $V_I = 12 \text{ V}$		40		μs
V _{tr}	Load transient voltage	$V_I = 12 \text{ V}$		± 150		mV
T _{coeff}	Temperature coefficient	$T_{ref} = -30 \dots +90 \text{ }^\circ\text{C}$, I_{Omax}		-0.6		mV/ $^\circ\text{C}$
t _s	Start-up V_I on to $0.9 \times V_O$	$I_O = I_{Omax}$, V_{Inom}		7		ms
t _r	Ramp-up, $V_I \dots 0.9 \times V_O$	$I_O = I_{Omax}$, V_{Inom}		3		ms
t _f	Fall time, V_I to $0.1 \times V_O$	$I_O = I_{Omax}$, V_{Inom}		1		ms
t _f	Fall time, V_I to $0.1 \times V_O$	$I_O = 0 \text{ A}$, V_{Inom}		16		s
t _{RC}	RC shut-down time $0.1 \times V_O$	$I_O = I_{Omax}$, V_{Inom}		1		ms
t _{RC}	RC start-up time $0.9 \times V_O$	$I_O = I_{Omax}$, V_{Inom}		7		ms
t _{RC}	RC fall time, $0.1 \times V_O$	$I_O = 0 \text{ A}$, V_{Inom}		15		s
I _O	Output current		0		16	A
P _{Omax}	Max output power		80			W
I _{lim}	Current limiting threshold	$T_{ref} < T_{refmax}$	19			A
V _{Oac}	Output ripple	20 Hz ... 5 MHz, I_{Omax}		50		mV _{p-p}
η	Efficiency - 50% load	$I_O = 0.5 \times I_{Omax}$, $V_O = 3.30 \text{ V}$		94.5		%
η	Efficiency - 100% load	$I_O = I_{Omax}$, $V_O = 3.30 \text{ V}$	91.0	94.3		%
P _d	Power Dissipation	$I_O = I_{Omax}$, $V_O = 3.30 \text{ V}$		4.8	7.9	W
F _o	Switching frequency	$I_O = (0 \dots 1) \times I_{Omax}$	260	300	340	kHz
I _{sense}	Remote sense current				10	mA
I _I	Static input current $V_I = 8.3 \text{ V}$	$I_O = I_{Omax}$, $V_O = 3.30 \text{ V}$		10.2		A
MTBF	Predicted reliability			5		million hours

Adjusted to 5.0 Vout - Typical Characteristics

General conditions: Input filter 4 x 4.7 μ F, Output filter 2 x 150 μ F

Efficiency

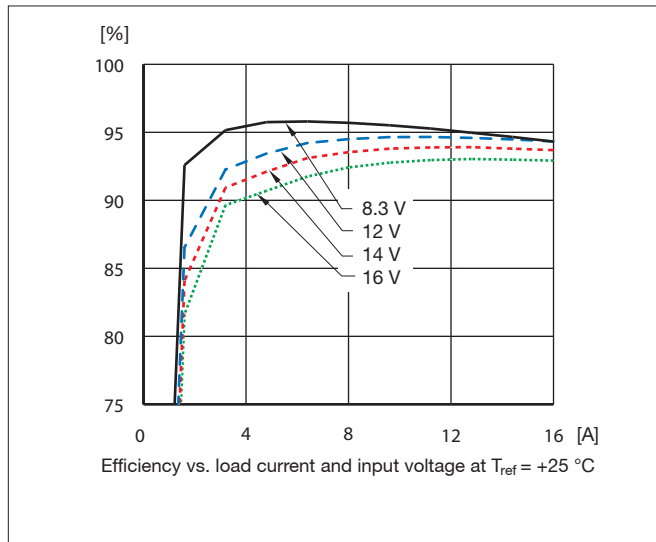

Power Dissipation

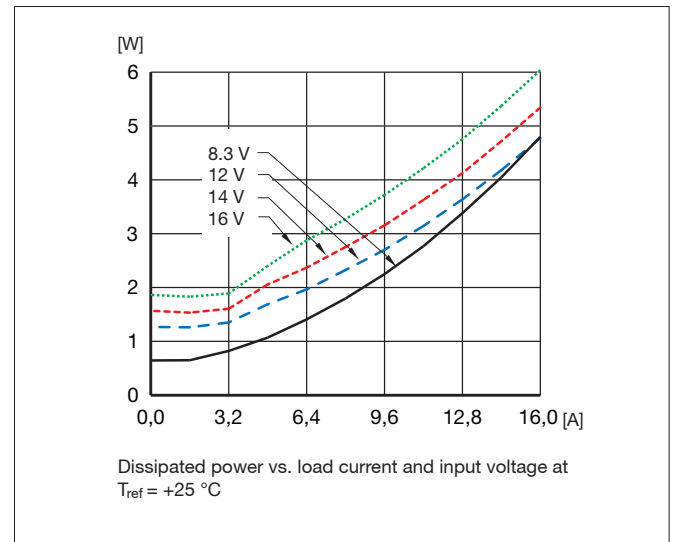

Output Current Derating at 12 V input

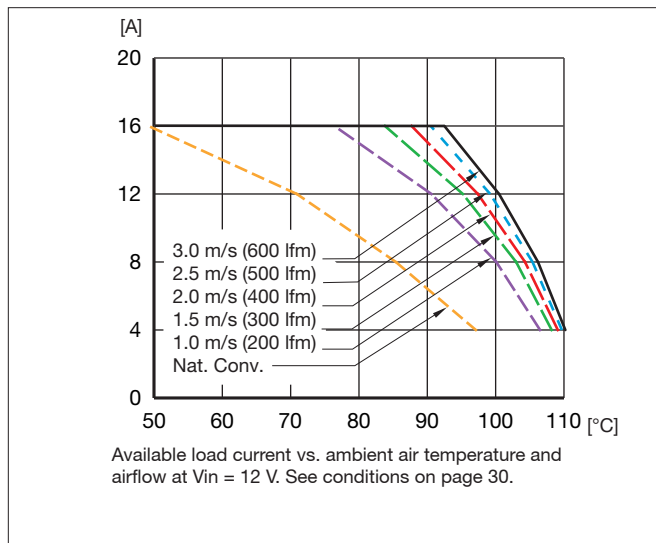

Output Characteristic

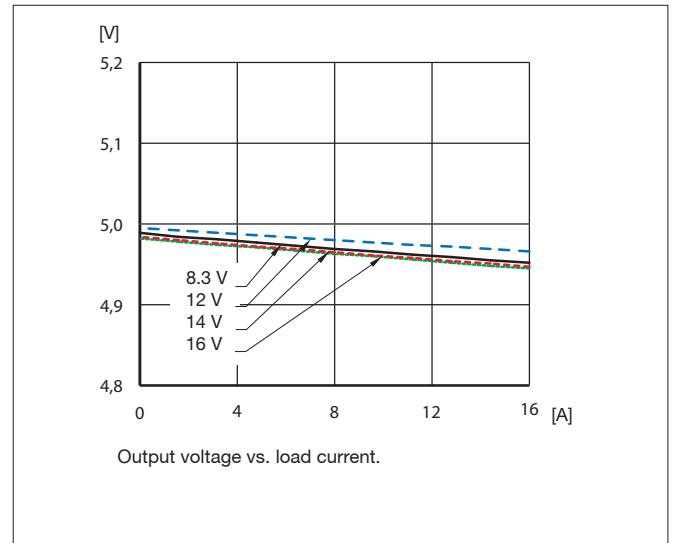

Start-Up

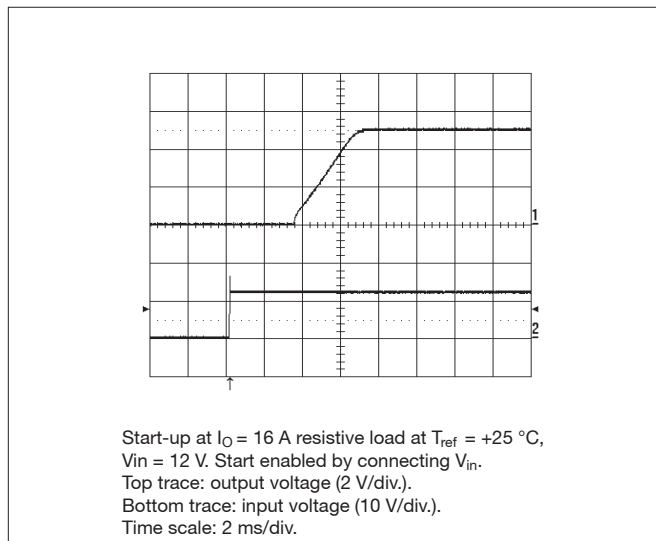

Turn Off

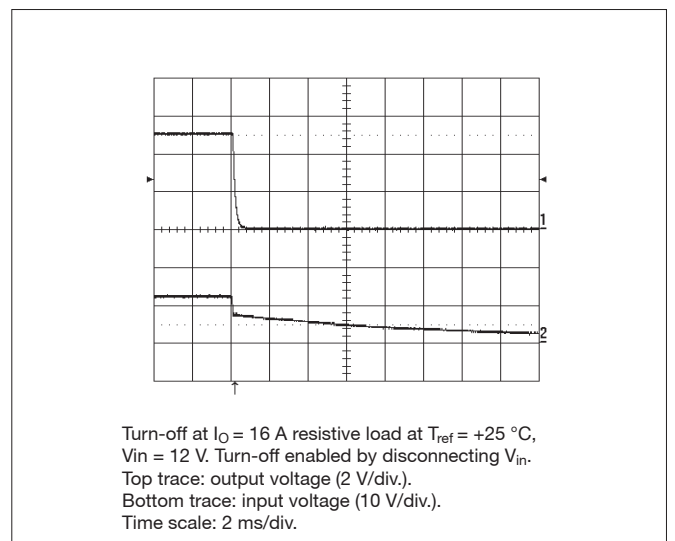

Adjusted to 5.0 Vout - Typical Characteristics

General conditions: Input filter 4 x 4.7 μ F, Output filter 2 x 150 μ F

Output Ripple

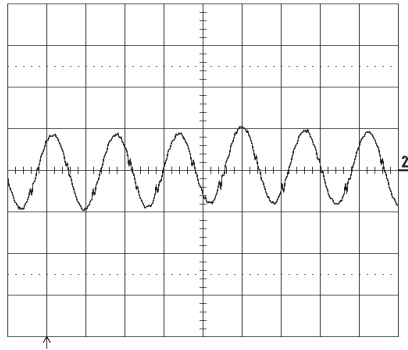

Output voltage ripple (20 mV/div.) at $T_{ref} = +25\text{ }^{\circ}\text{C}$,
 $V_{in} = 12\text{ V}$, $I_O = 16\text{ A}$ resistive load.
Band width = 5 MHz.
Time scale: 2 μ s/div.

Transient

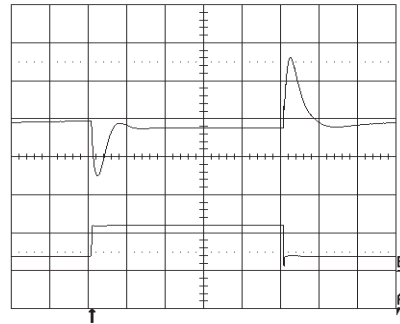

Output voltage response to load current step-change
(4-12-4 A) at $T_{ref} = +25\text{ }^{\circ}\text{C}$, $V_{in} = 12\text{ V}$. $dI/dt = 5\text{ A}/\mu\text{s}$
Top trace: output voltage (ac) (100 mV/div.).
Bottom trace: load current (dc) (10 A/div.)
Time scale: 0.1 ms/div.

EMC Specification

The conducted EMI measurement was performed using a regulator placed directly on the test bench. The fundamental switching frequency for PMB 8000 is 300 kHz. The measurement below has been performed with $V_{in} = 12\text{ V}$, $V_{out} = 5\text{ V}$ and max load. Input filter $4 \times 4.7\text{ }\mu\text{F}$ and output filter $2 \times 150\text{ }\mu\text{F}$ was used during the measurement.

Conducted EMI Input terminal value (typ)

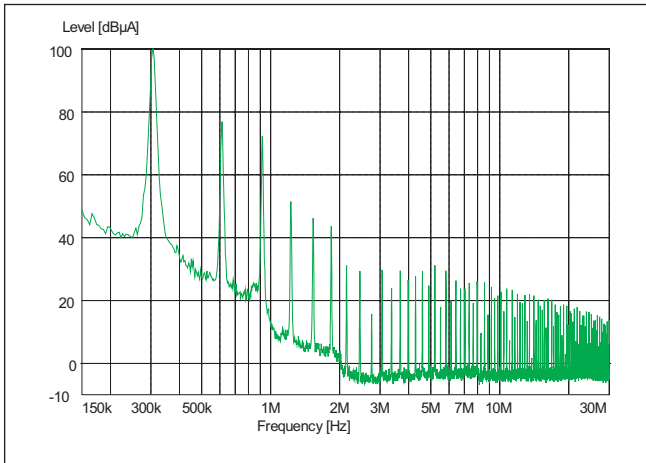

PMB 8818.

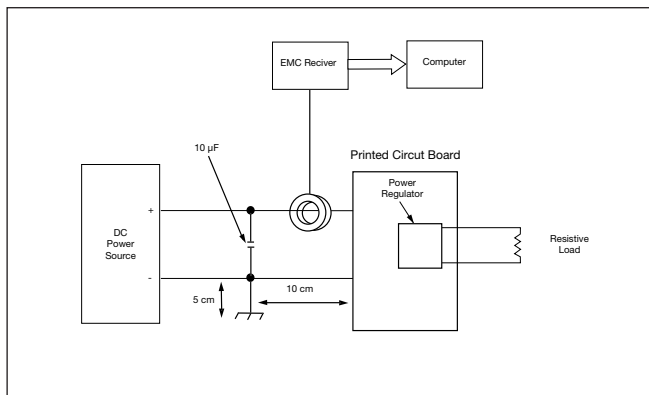

Test set up.

Layout Recommendation

The radiated EMI performance of the DC/DC regulator will be optimised by including a ground plane in the PCB area under the DC/DC regulator. This approach will return switching noise to ground as directly as possible, with improvements to both emissions and susceptibility.

Output ripple and noise

The circuit below has been used for the ripple and noise measurements on the PMB 8000 Series DC/DC regulators.

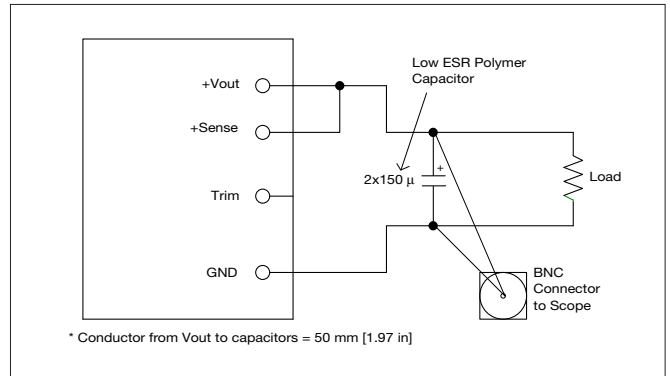

Output ripple and noise test setup

Operating Information

Output Voltage Adjust (V_{adj})

All PMB 8000 Series DC/DC regulators have an Output Voltage adjust pin (V_{adj}). This pin can be used to adjust the output voltage above output voltage initial setting (0.75 V). When increasing the output voltage the maximum power rating of the converter remains the same, and the output current capability will therefore decrease correspondingly. To increase the output voltage a resistor or a voltage signal should be connected/applied between V_{adj} pin and GND, pin 5. The resistor/voltage signal value for some standard output trims are given below, for other voltage set points use the formulas to calculate the correct resistor or voltage signal. For output voltages of 5.25 V and higher the input voltage is restricted to maximum 14 V_{in}.

Formula 1: $R_{adj} = (10\,500 / (V_{out} - 0.7525)) - 1000$ (ohm)

Formula 2: $V_{trim} = (0.7 - 0.0667 \times (V_{out} - 0.7525))$ (V)

Vout (V)	Radj (kohm)	Vtrim (V)
0.75	Open	Open
1.0	41.42	0.684
1.2	22.46	0.670
1.5	13.05	0.650
1.8	9.024	0.630
2.5	5.009	0.583
3.3	3.122	0.530
5.00	1.472	0.417
5.50	1.212	0.383

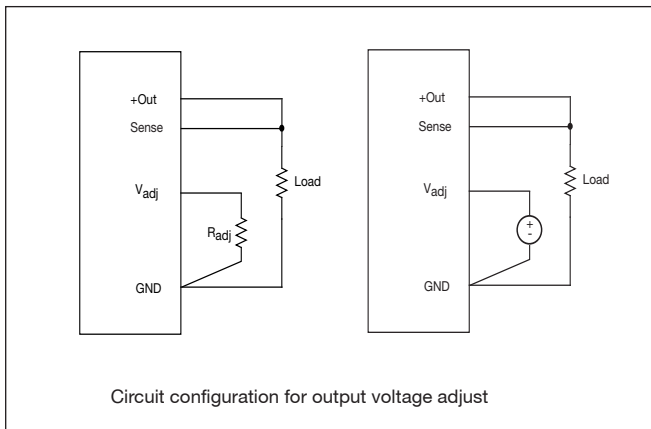

Input Voltage

The input voltage range 8.3...16 V_{dc} makes the PMB 8000 easy to use in intermediate bus applications when powered by a non-regulated bus converter or a regulated bus converter. For output voltage trims over 5.25 V_{out} the input voltage must be reduced to a maximum of 14 V in order to maintain specified data.

Turn off input voltage

The PMB 8000 Series DC/DC regulators monitor the input voltage and will turn on and turn off at predetermined levels. The minimum hysteresis between turn on and turn off input voltage is 0.2 V where the turn on input voltage is the highest.

Remote Control (RC)

Standard Version with "positive logic".

The RC pin may be used to turn on or turn off the regulator using a suitable open collector function. Turn off is achieved by connecting the RC pin to ground. The regulator will run in normal operation when the RC pin is left open.

RC	Regulator condition	min	typ	max	Unit
Low level referenced to GND	OFF	-0.3		0.3	V
Open	ON	1.7		16	V

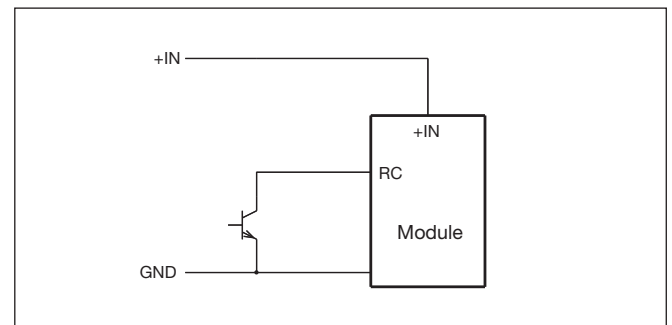

Option "negative logic"

The RC pin may be used to turn on or turn off the regulator using a suitable open collector function. Turn off is achieved by connecting the RC pin to the input voltage. The regulator will run in normal operation when the RC pin is left open.

RC	Regulator condition	min	typ	max	Unit
High level referenced to GND	OFF	1.7		16	V
Open	ON				

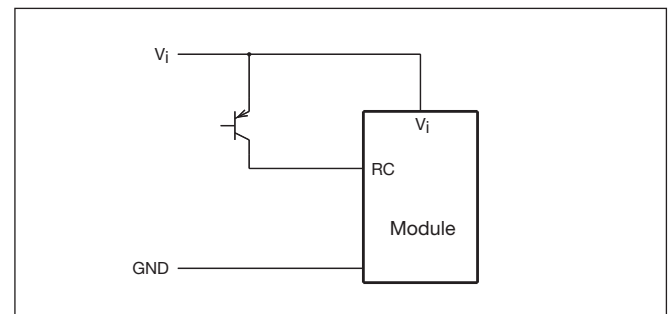

Operating Information

Remote Sense

All PMB 8000 Series DC/DC regulators have a positive remote sense pin that can be used to compensate for moderate amounts of resistance in the distribution system and allow for voltage regulation at the load or other selected point. The remote sense line will carry very little current and does not need a large cross sectional area. However, the sense line on the PCB should be located close to a ground trace or ground plane. The remote sense circuitry will compensate for up to 10% voltage drop between the sense voltage and the voltage at the output pins from V_{ONOM} . If the remote sense is not needed the sense pin should be left open or connected to the positive output.

Current Limit Protection

The PMB 8000 Series DC/DC regulators include current limiting circuitry that allows them to withstand continuous overloads or short circuit conditions on the output. The output voltage will decrease towards zero for output currents in excess of max output current (I_{OMAX}). When the current limit is reached the regulator will go into hiccup mode. The current limit is temperature dependent, i.e. the limit decrease at higher operating temperature, the regulator is guaranteed to start at $I_{OMAX} \times 1.25$ @ $T_{REF} 115^{\circ}C$. The regulator will resume normal operation after removal of the overload. The load distribution system should be designed to carry the maximum output short circuit current specified.

Over Temperature Protection (OTP)

The PMB 8000 Series DC/DC regulators are protected from thermal overload by an internal over temperature shutdown circuit. When the PCB temperature near the IC circuit reaches $130^{\circ}C$ the converter will shut down immediately. The regulator will make continuous attempts to start up (non-latching mode) and resume normal operation automatically when the temperature has dropped below the temperature threshold.

Input And Output Impedance

The impedance of both the power source and the load will interact with the impedance of the DC/DC regulator. It is most important to have a low characteristic impedance, both at the input and output, as the regulators have a low energy storage capability. Use capacitors across the input if the source inductance is greater than $4.7 \mu H$. Suitable input capacitors are $22 \mu F - 220 \mu F$ low ESR ceramics.

Minimum Required External Capacitors

Required Input Filter

External input capacitors are required to increase the lifetime of the internal capacitors. Low ESR ceramics should be used, the minimum input capacitance is stated below:

PMB 8818T P 2 x 4.7 μF

Optional Input Filter

To minimize input ripple and to ensure even better stability more capacitors can be added, see table below. Consider the max output power in a given application and choose sufficient capacitors to obtain desired ripple level. Make sure that the extra capacitors are placed near the input pins. The table below is just an example since the board layout also has effect on the result.

Output power	Desired input ripple (mV _{p-p})		
	150	250	500
0-20 W	2 x 4.7 μF	-----	-----
20-40 W	5 x 4.7 μF	2 x 4.7 μF	-----
40-60 W	8 x 4.7 μF	4 x 4.7 μF	2 x 4.7 μF
60-80 W	11 x 4.7 μF	7 x 4.7 μF	4 x 4.7 μF

Note: All output characteristics in the datasheet are measured with 4 x 4.7 μF at the input pins.

Required output filter

External output capacitance is also required to reduce the output ripple and to obtain specified load step response. It is recommended to use low ESR polymer capacitors or low ESR ceramic capacitors.

Minimum requirement:

PMB 8818T P 2 x 150 μF . (low ESR polymer type).

This is the output filter used in the verification and needed to meet the specification.

Maximum Capacitive Load

When powering loads with significant dynamic current requirements, the voltage regulation at the load can be improved by addition of decoupling capacitance at the load. The most effective technique is to locate low ESR ceramic capacitors as close to the load as possible, using several capacitors to lower the total ESR. These ceramic capacitors will handle short duration high-frequency components of dynamic load changes. In addition, higher values of capacitors (electrolytic capacitors) should be used to handle the mid-frequency components. It is equally important to use good design practice when configuring the DC distribution system.

Low resistance and low inductance PCB layouts and cabling should be used. Remember that when using remote sensing, all resistance (including the ESR), inductance and capacitance of the distribution system is within the feedback loop of the regulator. This can affect on the regulators compensation and the resulting stability and dynamic response performance.

Very low ESR and high capacitance must be used with care. A "rule of thumb" is that the total capacitance must never exceed typically 500-700 μF if only low ESR ($< 2m\Omega$) ceramic capacitors are used. If more capacitance is needed, a combination of low ESR type and electrolytic capacitors should be used, otherwise the stability will be affected.

The PMB 8000 series regulator can accept up to 8mF of capacitive load on the output at full load. This gives <math>< 500 \mu\text{F}/\text{A}</math> of I_O . When using that large capacitance it is important to consider the selection of output capacitors; the resulting behavior is a combination of the amount of capacitance and ESR.

A combination of low ESR and output capacitance exceeding 8mF for PMB 8818 can cause the regulator into over current protection mode (hick-up) due to high start up current. The output filter must therefore be designed without exceeding the above stated capacitance levels if the ESR is lower then 30-40 mΩ.

Parallel Operation

The PMB 8000 Series DC/DC regulators can be connected in parallel with a common input. Paralleling is accomplished by connecting the output voltage pins directly and using a load sharing device on the input. Layout considerations should be made to avoid load imbalance. For more details on paralleling, please consult your local applications support.

Thermal Considerations

General

The PMB 8000 Series DC/DC regulators are designed to operate in a variety of thermal environments, however sufficient cooling should be provided to help ensure reliable operation. Heat is removed by conduction, convection and radiation to the surrounding environment. Increased airflow enhances the heat transfer via convection. Proper cooling can be verified by measuring the temperature at the reference point (T_{ref}).

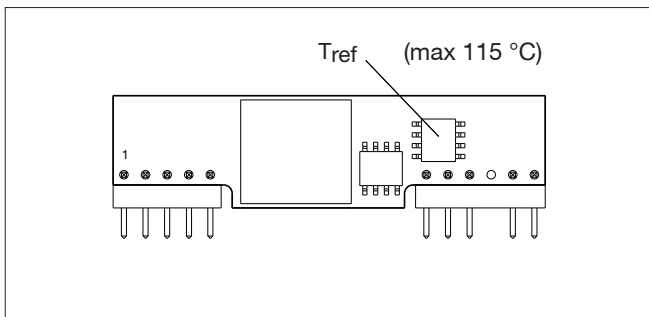

The PMB 8000 thermal testing is performed with the product mounted on an FR4 board 254 × 254 mm with 8 layers of 35 μm copper. Airflow is perpendicular to the T_{ref} side.

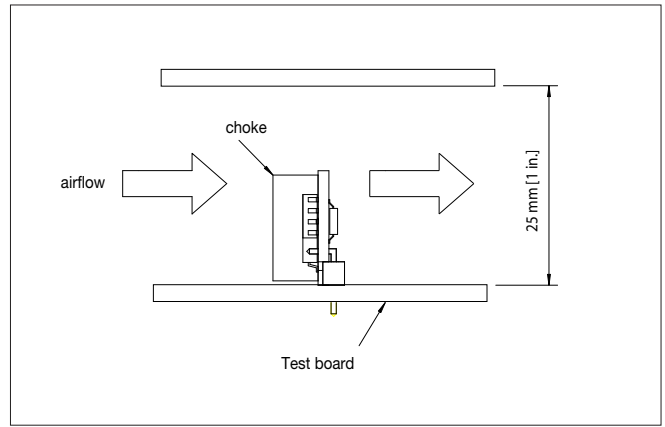

Calculation of ambient temperature

By using the thermal resistance the maximum allowed ambient temperature can be calculated.

1. The powerloss is calculated by using the formula $((1/\eta) - 1) \times \text{output power} = \text{power losses}$.
 η = efficiency of converter. E.g 88% = 0.88
2. Find the value of the thermal resistance for each product in the diagram by using the airflow speed at the output section of the converter. Take the thermal resistance x powerloss to get the temperature increase.
3. Max allowed calculated ambient temperature is: Max T_{ref} of DC/DC regulator – temperature increase.

E.g 5 V output at 1 m/s, full load, 12 V in:

A. $((\frac{1}{0.94}) - 1) \times 80 \text{ W} = 5.11 \text{ W}$

B. $5.11 \text{ W} \times 7.2 \text{ }^\circ\text{C}/\text{W} = 36.8 \text{ }^\circ\text{C}$

C. $115 \text{ }^\circ\text{C} - 36.8 \text{ }^\circ\text{C} = \text{max ambient temperature is } 78.2 \text{ }^\circ\text{C}$

The real temperature will be dependent on several factors, like PCB size and type, direction of airflow, air turbulence etc. It is recommended to verify the temperature by testing.

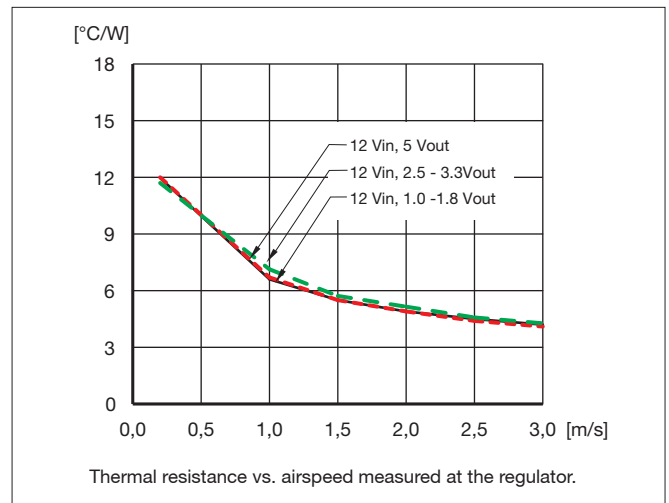

Soldering Information

The PMB 8000 series DC/DC regulators are intended for manual or wave soldering. The plastic body of the pin connectors resists soldering heat for limited time up to 260 °C. When hand soldering, care should be taken to avoid direct contact between the hot soldering iron tip and the pins for more than a few seconds in order to avoid melting of the plastic.

Delivery Package Information

The PMB 8000 series regulators are delivered in antistatic trays with Jedec standard outer dimensions. Tray capacity 25 pcs. Each box contains 4 full trays and one empty that functions as a lid.

Compatibility with RoHS requirements

The products are compatible with the relevant clauses and requirements of the RoHS directive 2011/65/EU and have a maximum concentration value of 0.1% by weight in homogeneous materials for lead, mercury, hexavalent chromium, PBB and PBDE and of 0.01% by weight in homogeneous materials for cadmium.

Exemptions in the RoHS directive utilized in Flex products are found in the Statement of Compliance document.

Flex fulfills and will continuously fulfill all its obligations under regulation (EC) No 1907/2006 concerning the registration, evaluation, authorization and restriction of chemicals (REACH) as they enter into force and is through product materials declarations preparing for the obligations to communicate information on substances in the products.

Reliability

The Mean Time Between Failure (MTBF) of the PMB 8000 series DC/DC regulator family is calculated to be greater than 5 million hours at full output power and a reference temperature of +40 °C using TelCordia SR 332.

© Flex 2017

The information and specifications in this technical specification is believed to be correct at the time of publication. However, no liability is accepted for inaccuracies, printing errors or for any consequences thereof. Flex reserves the right to change the contents of this technical specification at any time without prior notice.



Компания «ЭлектроПласт» предлагает заключение долгосрочных отношений при поставках импортных электронных компонентов на взаимовыгодных условиях!

Наши преимущества:

- Оперативные поставки широкого спектра электронных компонентов отечественного и импортного производства напрямую от производителей и с крупнейших мировых складов;
- Поставка более 17-ти миллионов наименований электронных компонентов;
- Поставка сложных, дефицитных, либо снятых с производства позиций;
- Оперативные сроки поставки под заказ (от 5 рабочих дней);
- Экспресс доставка в любую точку России;
- Техническая поддержка проекта, помощь в подборе аналогов, поставка прототипов;
- Система менеджмента качества сертифицирована по Международному стандарту ISO 9001;
- Лицензия ФСБ на осуществление работ с использованием сведений, составляющих государственную тайну;
- Поставка специализированных компонентов (Xilinx, Altera, Analog Devices, Intersil, Interpoint, Microsemi, Aeroflex, Peregrine, Syfer, Eurofarad, Texas Instrument, Miteq, Cobham, E2V, MA-COM, Hittite, Mini-Circuits, General Dynamics и др.);

Помимо этого, одним из направлений компании «ЭлектроПласт» является направление «Источники питания». Мы предлагаем Вам помощь Конструкторского отдела:

- Подбор оптимального решения, техническое обоснование при выборе компонента;
- Подбор аналогов;
- Консультации по применению компонента;
- Поставка образцов и прототипов;
- Техническая поддержка проекта;
- Защита от снятия компонента с производства.



Как с нами связаться

Телефон: 8 (812) 309 58 32 (многоканальный)

Факс: 8 (812) 320-02-42

Электронная почта: org@eplast1.ru

Адрес: 198099, г. Санкт-Петербург, ул. Калинина, дом 2, корпус 4, литера А.