

BARBARA-XW-PF

White version with ~75° wide beam

TECHNICAL SPECIFICATIONS:

Dimensions	Ø 70.0 mm
Height	41.7 mm
Fastening	socket
ROHS compliant	yes ⓘ

MATERIAL SPECIFICATIONS:

Component	Type	Material	Colour	Finish	Coating
BARBARA-XW-PF	Reflector	HRPC	white		





ORDERING INFORMATION:

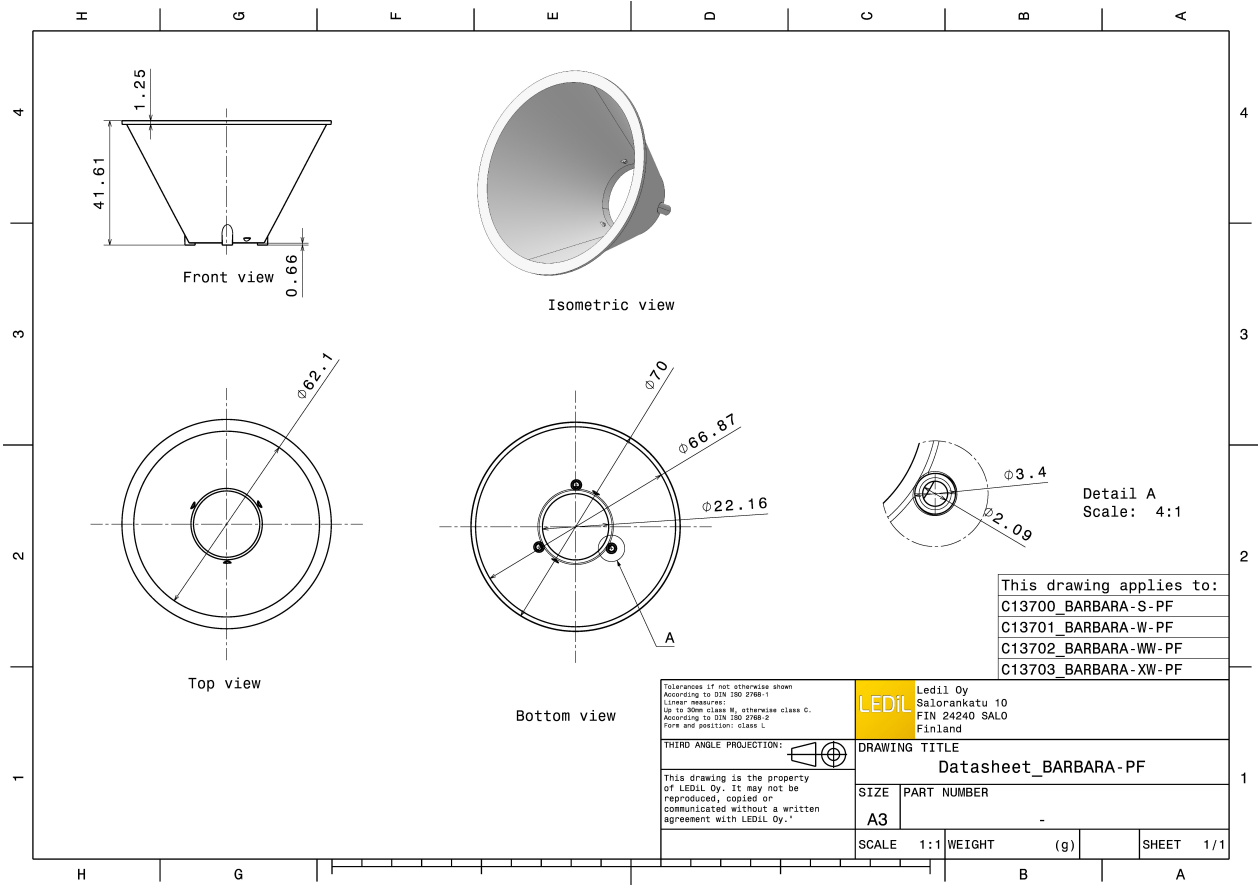

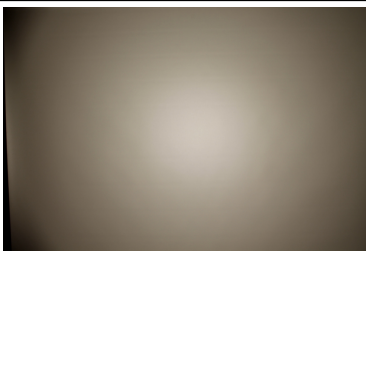
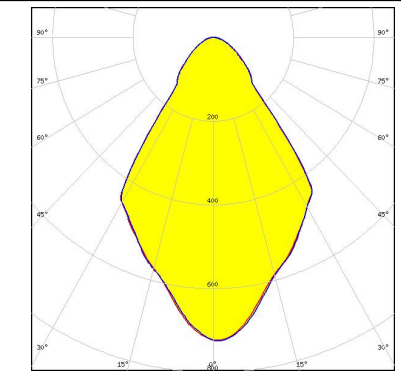
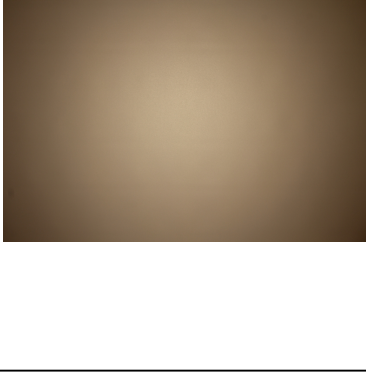

Component	Qty in box	MOQ	MPQ	Box weight (kg)
F13703_BARBARA-XW-PF » Box size: 480 x 280 x 300 mm	288	90	18	8.4

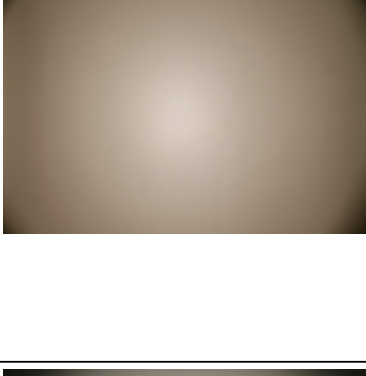
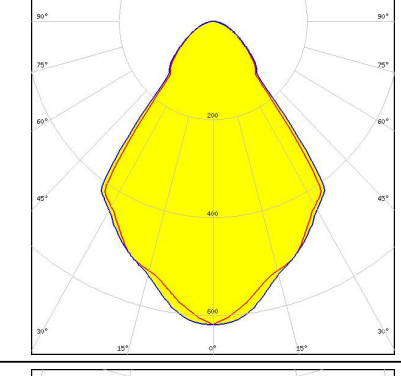
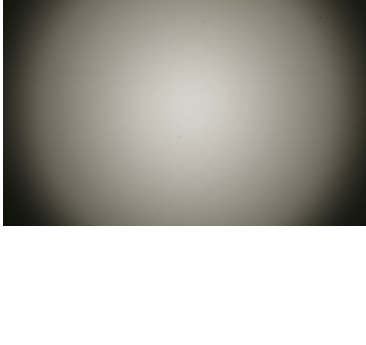
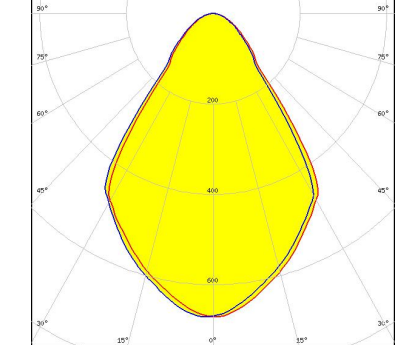

PHOTOMETRIC DATA (MEASURED):

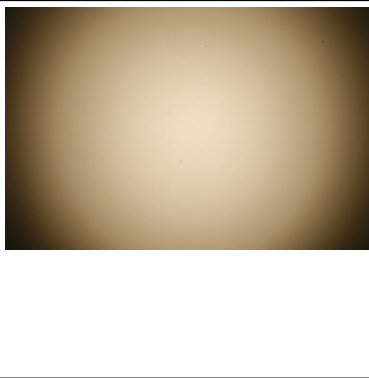
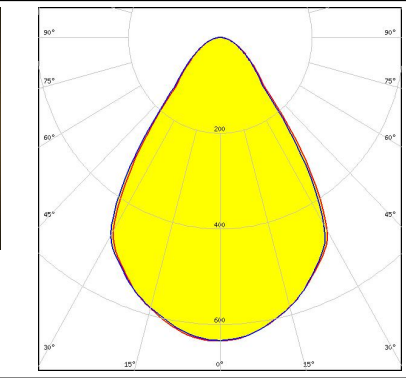
<p>bridgelux.</p> <p>LED V10 Gen7 FWHM 70.0° Efficiency 90 % Peak intensity 0.7 cd/lm LEDs/each optic 1 Light colour White</p> <p>Required components: C13709_PF-SOCKET-VERO13-18 Bender Wirth: 434 Typ L1</p>		
<p>bridgelux.</p> <p>LED V15 Gen6 FWHM 71.0° Efficiency 89 % Peak intensity 0.7 cd/lm LEDs/each optic 1 Light colour White</p> <p>Required components: C13709_PF-SOCKET-VERO13-18 Bender Wirth: 456 Typ L2</p>		
<p>bridgelux.</p> <p>LED V8 Gen6 FWHM 74.0° Efficiency 90 % Peak intensity 0.6 cd/lm LEDs/each optic 1 Light colour White</p> <p>Required components: C13761_PF-SOCKET-CXA15</p>		
<p>bridgelux.</p> <p>LED VERO13 FWHM 72.0° Efficiency 93 % Peak intensity 0.7 cd/lm LEDs/each optic 1 Light colour White</p> <p>Required components: C13709_PF-SOCKET-VERO13-18</p>		

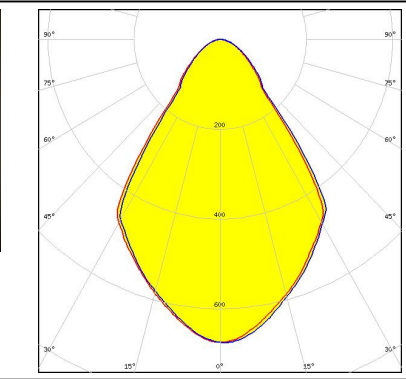
PHOTOMETRIC DATA (MEASURED):

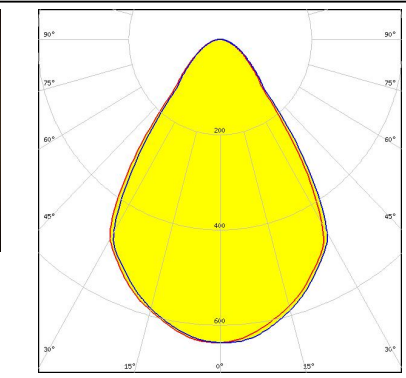
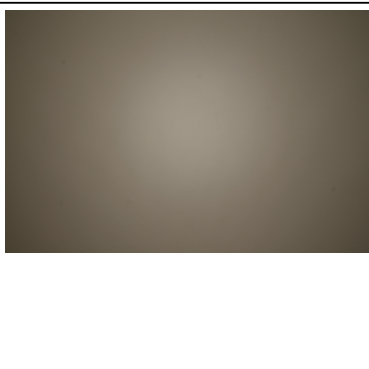
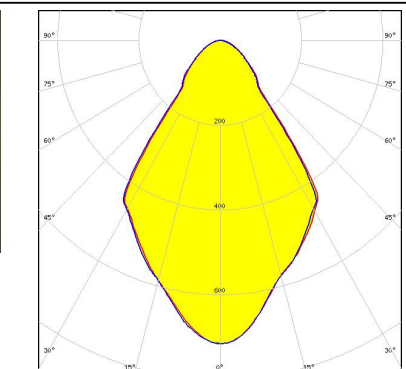
<p>bridgelux.</p> <p>LED VERO18 FWHM 72.0° Efficiency 93 % Peak intensity 0.6 cd/lm LEDs/each optic 1 Light colour White Required components: C13709_PF-SOCKET-VERO13-18</p>		
<p>bridgelux.</p> <p>LED Xenio Point 13mm FWHM 71.0° Efficiency 92 % Peak intensity 0.7 cd/lm LEDs/each optic 1 Light colour White Required components: C13709_PF-SOCKET-VERO13-18</p>		
<p>bridgelux.</p> <p>LED Xenio Point 18mm FWHM 72.0° Efficiency 91 % Peak intensity 0.6 cd/lm LEDs/each optic 1 Light colour White Required components: C13709_PF-SOCKET-VERO13-18</p>		
<p>CITIZEN</p> <p>LED CLL02x/CLU02x (LES10) FWHM 70.0° Efficiency 90 % Peak intensity 0.7 cd/lm LEDs/each optic 1 Light colour White Required components: C13709_PF-SOCKET-VERO13-18 Bender Wirth: 434 Typ L1</p>		

PHOTOMETRIC DATA (MEASURED):

CITIZEN

LED CLU700/701/702
 FWHM 70.0°
 Efficiency 90 %
 Peak intensity 0.8 cd/lm
 LEDs/each optic 1
 Light colour White
 Required components:
 C13709_PF-SOCKET-VERO13-18
 Bender Wirth: 434 Typ L1

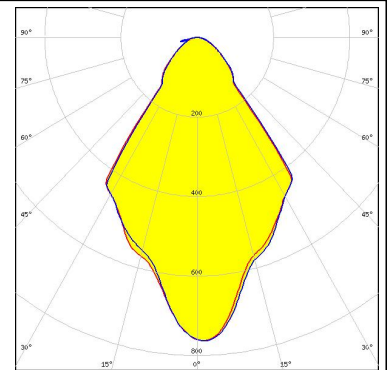
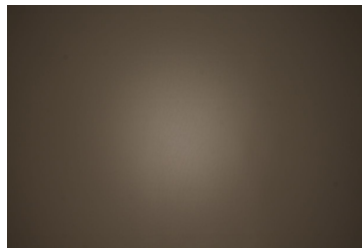

CREE

LED CXA/B 15xx
 FWHM 70.0°
 Efficiency 90 %
 Peak intensity 0.7 cd/lm
 LEDs/each optic 1
 Light colour White
 Required components:
 C13709_PF-SOCKET-VERO13-18
 Bender Wirth: 441 Typ L1

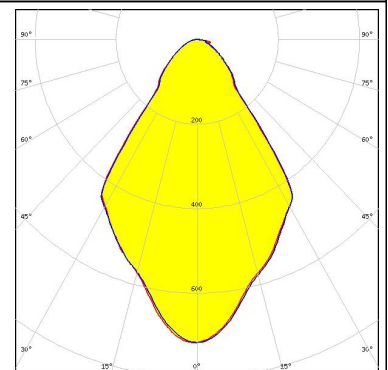
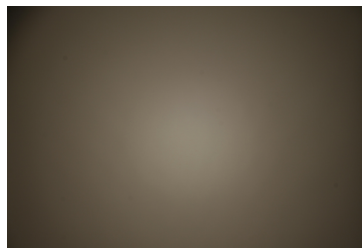

CREE

LED CXA/B 15xx
 FWHM 73.0°
 Efficiency 85 %
 Peak intensity 0.6 cd/lm
 LEDs/each optic 1
 Light colour White
 Required components:
 C13083_PF-SOCKET
 C14658_BARBARA-RZ-LENS

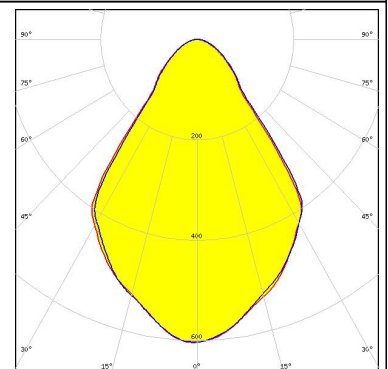
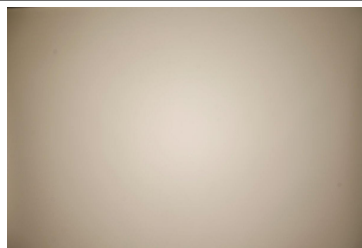

CREE

LED CXA/B 15xx
 FWHM 70.0°
 Efficiency 92 %
 Peak intensity 0.8 cd/lm
 LEDs/each optic 1
 Light colour White
 Required components:
 C14115_PF-SOCKET-CXA15-18



PHOTOMETRIC DATA (MEASURED):



LED CXA/B 1816 & CXA/B 1820 & CXA 1850
 FWHM 70.0°
 Efficiency 93 %
 Peak intensity 0.7 cd/lm
 LEDs/each optic 1
 Light colour White
 Required components:
 C14115_PF-SOCKET-CXA15-18

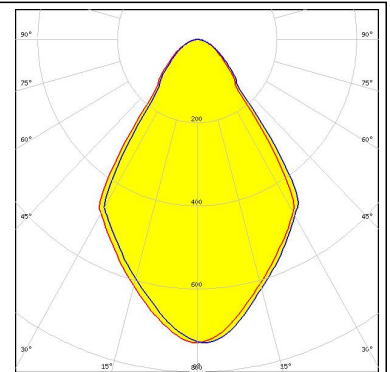

LED CXA/B 1816 & CXA/B 1820 & CXA 1850
 FWHM 67.0°
 Efficiency 82 %
 Peak intensity 0.7 cd/lm
 LEDs/each optic 1
 Light colour White
 Required components:
 C13709_PF-SOCKET-VERO13-18
 Bender Wirth: 437 Typ L1

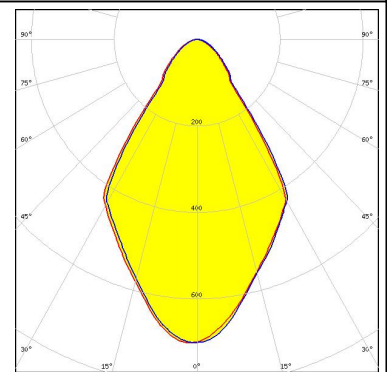
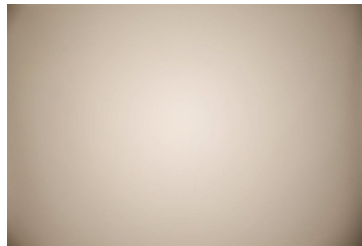

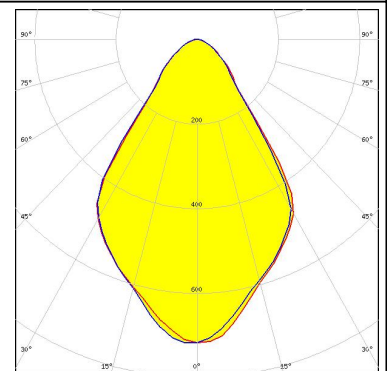
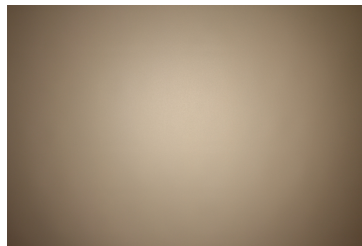

LED LUXEON CoB 1202/1203
 FWHM 71.0°
 Efficiency 92 %
 Peak intensity 0.7 cd/lm
 LEDs/each optic 1
 Light colour White
 Required components:
 C14037_PF-NSX-SOCKET



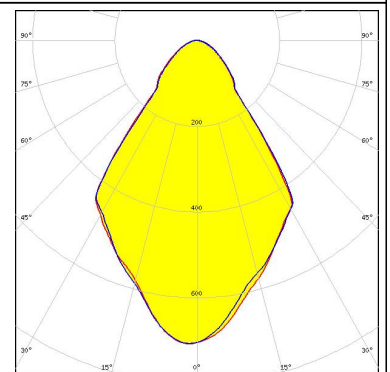
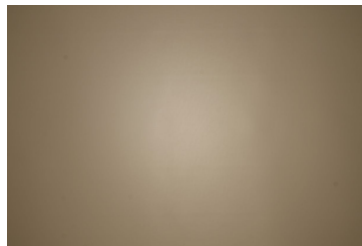

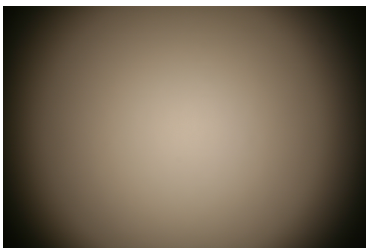
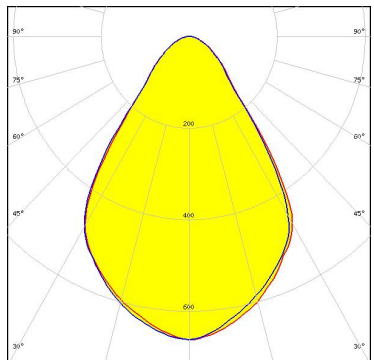

LED LUXEON CoB 1202/1203
 FWHM 71.0°
 Efficiency 90 %
 Peak intensity 0.7 cd/lm
 LEDs/each optic 1
 Light colour White
 Required components:
 C13709_PF-SOCKET-VERO13-18
 Bender Wirth: 438 Typ L1

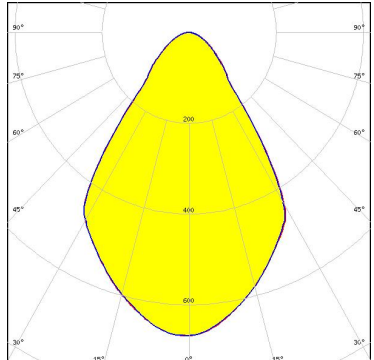
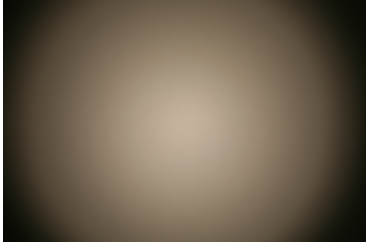
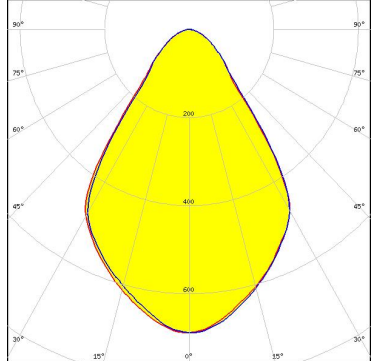

PHOTOMETRIC DATA (MEASURED):

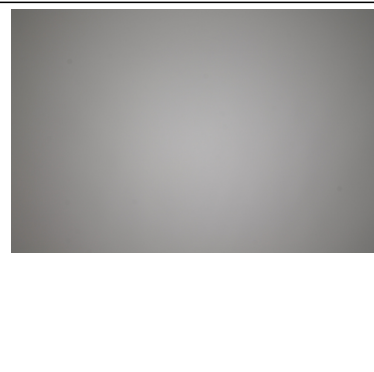
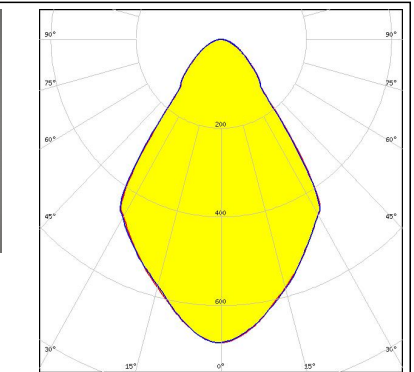
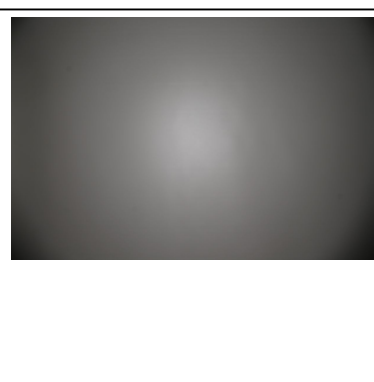
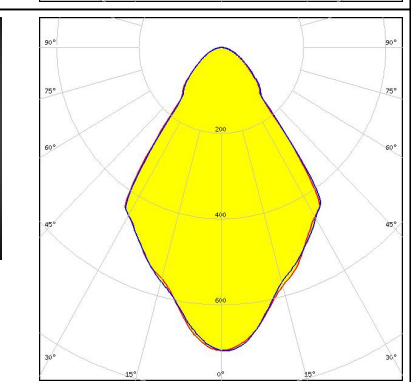
<p>LUMILEDS</p> <p>LED LUXEON CoB 1202s FWHM 75.0° Efficiency 92 % Peak intensity 0.7 cd/lm LEDs/each optic 1 Light colour White Required components: C13761_PF-SOCKET-CXA15</p>		
<p>NICHIA</p> <p>LED COB J-Type FWHM 72.0° Efficiency 93 % Peak intensity 0.7 cd/lm LEDs/each optic 1 Light colour White Required components: C14037_PF-NSX-SOCKET</p>		
<p>NICHIA</p> <p>LED COB J-Type FWHM 70.0° Efficiency 89 % Peak intensity 0.7 cd/lm LEDs/each optic 1 Light colour White Required components: C13709_PF-SOCKET-VERO13-18 Bender Wirth: 463 Typ L2</p>		
<p>NICHIA</p> <p>LED COB L-Type (LES 11) FWHM 72.0° Efficiency 93 % Peak intensity 0.7 cd/lm LEDs/each optic 1 Light colour White Required components: C14037_PF-NSX-SOCKET</p>		

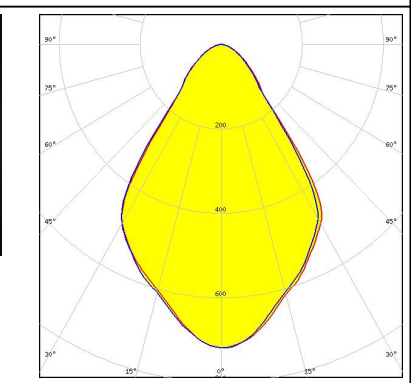
PHOTOMETRIC DATA (MEASURED):

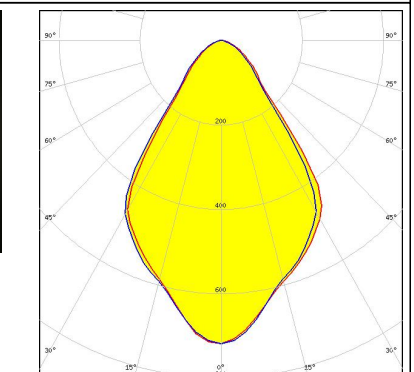
<p>NICHIA</p> <p>LED COB L-Type (LES 11) FWHM 70.0° Efficiency 90 % Peak intensity 0.7 cd/lm LEDs/each optic 1 Light colour White Required components: C13709_PF-SOCKET-VERO13-18 Bender Wirth: 438 Typ L1</p>		
<p>NICHIA</p> <p>LED COB L-Type (LES 9) FWHM 70.0° Efficiency 90 % Peak intensity 0.7 cd/lm LEDs/each optic 1 Light colour White Required components: C13709_PF-SOCKET-VERO13-18 Bender Wirth: 438 Typ L1</p>		
<p>NICHIA</p> <p>LED COB L-Type (LES 9) FWHM 72.0° Efficiency 93 % Peak intensity 0.7 cd/lm LEDs/each optic 1 Light colour White Required components: C14037_PF-NSX-SOCKET</p>		
<p>NICHIA</p> <p>LED NSCxL036A FWHM 71.0° Efficiency 91 % Peak intensity 0.7 cd/lm LEDs/each optic 1 Light colour White Required components: C14037_PF-NSX-SOCKET</p>		

PHOTOMETRIC DATA (MEASURED):

OSRAM

Opto Semiconductors

LED OSTAR Stage (S2WP)
FWHM 74.0°
Efficiency 83 %
Peak intensity 0.6 cd/lm
LEDs/each optic 1
Light colour White
Required components:
C13083_PF-SOCKET
C14658_BARBARA-RZ-LENS



OSRAM

Opto Semiconductors

LED Soleriq S13
FWHM 70.0°
Efficiency 90 %
Peak intensity 0.7 cd/lm
LEDs/each optic 1
Light colour White
Required components:
C13709_PF-SOCKET-VERO13-18
Bender Wirth: 437 Typ L1

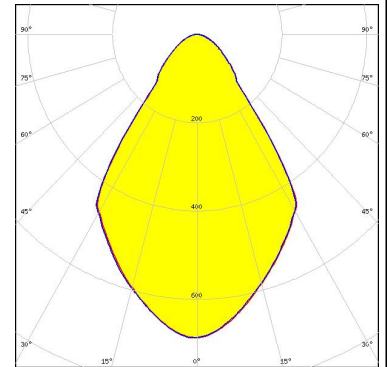
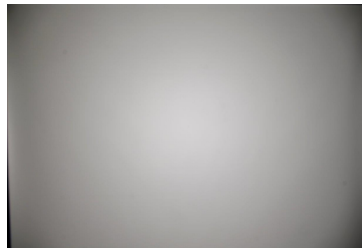

SAMSUNG

LED LC026B / 033B / 040B
FWHM 70.0°
Efficiency 90 %
Peak intensity 0.6 cd/lm
LEDs/each optic 1
Light colour White
Required components:
C13709_PF-SOCKET-VERO13-18
Bender Wirth: 450 Typ L2

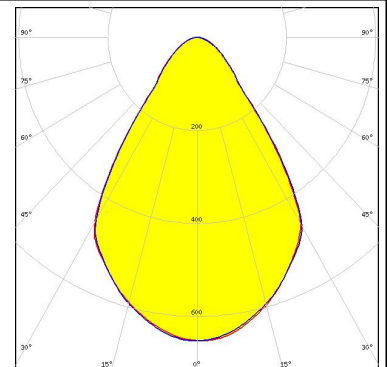
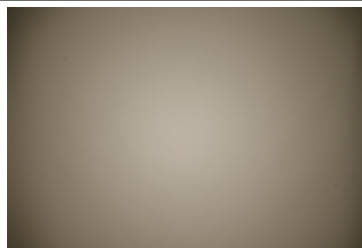

XICATO

LED XTM - 19mm LES
FWHM 70.0°
Efficiency 83 %
Peak intensity 0.6 cd/lm
LEDs/each optic 1
Light colour White
Required components:
C14636_XTM-PF-ADAPTER

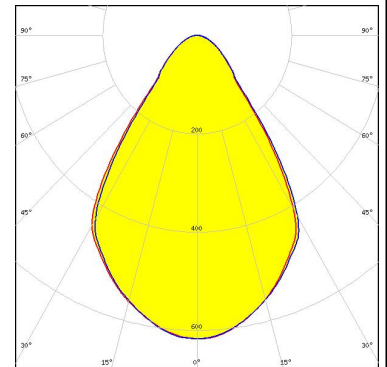
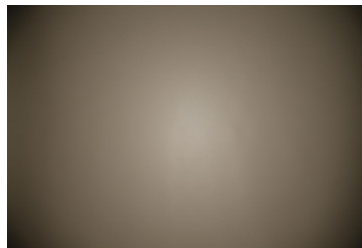

PHOTOMETRIC DATA (MEASURED):

XICATO

LED XTM - 9mm LES
FWHM 70.0°
Efficiency 86 %
Peak intensity 0.7 cd/lm
LEDs/each optic 1
Light colour White
Required components:
C14636_XTM-PF-ADAPTER

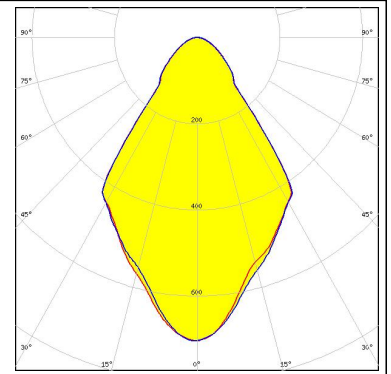
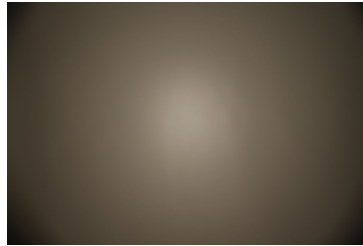

PHOTOMETRIC DATA (SIMULATED):



LED V10 Gen7
FWHM 66.0°
Efficiency 88 %
Peak intensity 0.9 cd/lm
LEDs/each optic 1
Light colour White
Required components:
C13709_PF-SOCKET-VERO13-18
Bender Wirth: 486 Typ L1

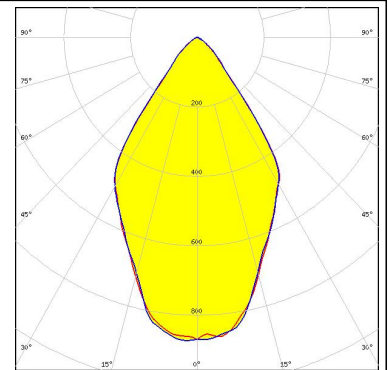

LED LUXEON CoB Compact
FWHM 75.0°
Efficiency 92 %
Peak intensity 0.7 cd/lm
LEDs/each optic 1
Light colour White
Required components:
C13761_PF-SOCKET-CXA15



LED CxM-14 (19x19)
FWHM 70.0°
Efficiency 90 %
Peak intensity 0.7 cd/lm
LEDs/each optic 1
Light colour White
Required components:
C13709_PF-SOCKET-VERO13-18
Bender Wirth: 433 Typ L1



LED CxM-9 (13.5x13.5)
FWHM 70.0°
Efficiency 90 %
Peak intensity 0.7 cd/lm
LEDs/each optic 1
Light colour White
Required components:
C13709_PF-SOCKET-VERO13-18
Bender Wirth: 434 Typ L1

PHOTOMETRIC DATA (SIMULATED):

OSRAM

Opto Semiconductors

LED Soleriq S15
FWHM 74.0°
Efficiency 95 %
Peak intensity 0.7 cd/lm
LEDs/each optic 1
Light colour White

Required components:
C13709_PF-SOCKET-VERO13-18
Bender Wirth: 433 Typ L1

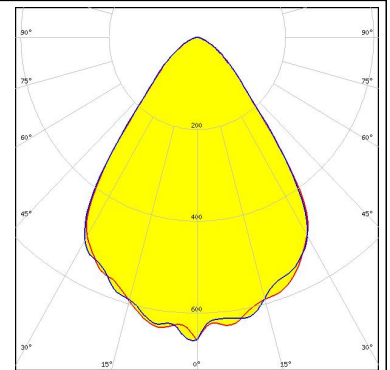

SAMSUNG

LED LC010C
FWHM 66.0°
Efficiency 89 %
Peak intensity 0.9 cd/lm
LEDs/each optic 1
Light colour White

Required components:
C13709_PF-SOCKET-VERO13-18
Bender Wirth: 479 Typ L1

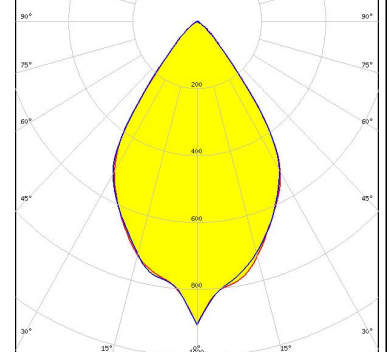

SAMSUNG

LED LC020C
FWHM 70.0°
Efficiency 88 %
Peak intensity 0.8 cd/lm
LEDs/each optic 1
Light colour White

Required components:
C13709_PF-SOCKET-VERO13-18
Bender Wirth: 479 Typ L1

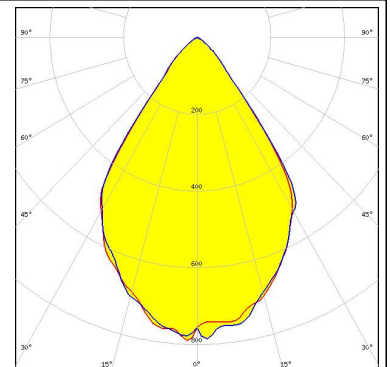

SAMSUNG

LED LC040C
FWHM 70.0°
Efficiency 84 %
Peak intensity 0.7 cd/lm
LEDs/each optic 1
Light colour White

Required components:
C13709_PF-SOCKET-VERO13-18
Bender Wirth: 480 Typ L1

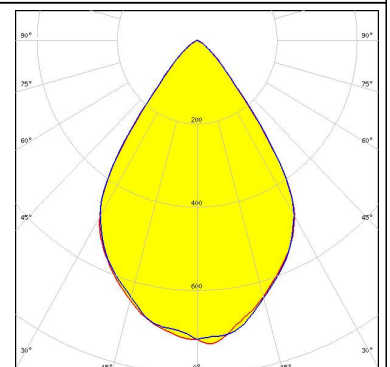

PHOTOMETRIC DATA (SIMULATED):

	
SEOUL SEMICONDUCTOR	
LED	ZC12/18
FWHM	70.0°
Efficiency	90 %
Peak intensity	0.7 cd/lm
LEDs/each optic	1
Light colour	White
Required components:	
C13709_PF-SOCKET-VERO13-18	
Bender Wirth: 433 Typ L1	
<hr/>	
	
SEOUL SEMICONDUCTOR	
LED	ZC4/6
FWHM	70.0°
Efficiency	90 %
Peak intensity	0.7 cd/lm
LEDs/each optic	1
Light colour	White
Required components:	
C13709_PF-SOCKET-VERO13-18	
Bender Wirth: 434 Typ L1	

GENERAL INFORMATION:

NOTE: The typical beam angle will be changed by different color, chip size and chip position tolerance. The typical total beam angle is the full angle measured where the luminous intensity is half of the peak value.

Due to use of high power COB's with this product, special attention to proper thermal design is highly recommended. LEDiL has no liability for direct, indirect or consecutive damages arising from the LEDiL products being used outside of the recommended temperature range.

MATERIALS:

As part of our continuous research and improvement processes, and to ensure the best possible quality and availability of our products, LEDiL reserves the right to change material grades without notice.

PRODUCT DATA USER AGREEMENT AND DISCLAIMER:

The measured data in the provided downloadable LEDiL Product Datasheets and Mechanical 2D-Drawings is rounded and provided as reference for planning. LEDiL Oy's optical specifications have been verified by conducting performance testing of the products in accordance with the company's quality system. The reported data are averaged results of multiple measurements with typical variation. LEDiL Oy reserves the right to without prior notification make changes and improvements to its products.

LEDiL Oy assumes neither warranty, nor guarantee nor any other liability of any kind for the contents and correctness of the provided data. The provided data has been generated with highest diligence but the provided data may in reality not represent the complete possible variation range of all intrinsic parameters. Therefore, in certain cases a deviation from the provided data could occur.

LEDiL Oy reserves the right to undertake technical changes of its products without further notification which could lead to changes in the provided data. LEDiL Oy assumes no liability of any kind for the possible deviation from any provided data or any other damage resulting from the usage of the provided data.

The user agrees to this disclaimer and user agreement with the download or usage of the provided files.

LEDiL Oy

Joensuunkatu 13
FI-24240 SALO
Finland

LEDiL Inc.

228 West Page Street
Suite D
Sycamore IL 60178
USA

Local sales and technical support

www.ledil.com/where_to_buy

Shipping locations

Salo, Finland
Hong Kong, China

Distribution Partners

www.ledil.com/where_to_buy



Компания «ЭлектроПласт» предлагает заключение долгосрочных отношений при поставках импортных электронных компонентов на взаимовыгодных условиях!

Наши преимущества:

- Оперативные поставки широкого спектра электронных компонентов отечественного и импортного производства напрямую от производителей и с крупнейших мировых складов;
- Поставка более 17-ти миллионов наименований электронных компонентов;
- Поставка сложных, дефицитных, либо снятых с производства позиций;
- Оперативные сроки поставки под заказ (от 5 рабочих дней);
- Экспресс доставка в любую точку России;
- Техническая поддержка проекта, помощь в подборе аналогов, поставка прототипов;
- Система менеджмента качества сертифицирована по Международному стандарту ISO 9001;
- Лицензия ФСБ на осуществление работ с использованием сведений, составляющих государственную тайну;
- Поставка специализированных компонентов (Xilinx, Altera, Analog Devices, Intersil, Interpoint, Microsemi, Aeroflex, Peregrine, Syfer, Eurofarad, Texas Instrument, Miteq, Cobham, E2V, MA-COM, Hittite, Mini-Circuits, General Dynamics и др.);

Помимо этого, одним из направлений компании «ЭлектроПласт» является направление «Источники питания». Мы предлагаем Вам помощь Конструкторского отдела:

- Подбор оптимального решения, техническое обоснование при выборе компонента;
- Подбор аналогов;
- Консультации по применению компонента;
- Поставка образцов и прототипов;
- Техническая поддержка проекта;
- Защита от снятия компонента с производства.



Как с нами связаться

Телефон: 8 (812) 309 58 32 (многоканальный)

Факс: 8 (812) 320-02-42

Электронная почта: org@eplast1.ru

Адрес: 198099, г. Санкт-Петербург, ул. Калинина, дом 2, корпус 4, литера А.