



24AA16H/24LC16BH

16K I²C™ Serial EEPROM with Half-Array Write-Protect

Device Selection Table

| Part Number | Vcc Range | Max. Clock Frequency | Temp. Ranges |
|-------------|-----------|------------------------|--------------|
| 24AA16H | 1.7-5.5 | 400 kHz ⁽¹⁾ | I |
| 24LC16BH | 2.5-5.5 | 400 kHz | I, E |

Note 1: 100 kHz for Vcc < 2.5V

Features:

- Single Supply with Operation Down to 1.7V for 24AA16H Devices, 2.5V for 24LC16BH Devices
- Low-Power CMOS Technology:
 - Read current 1 mA, max.
 - Standby current 1 μ A, max.
- 2-Wire Serial Interface, I²C™ Compatible
- Schmitt Trigger Inputs for Noise Suppression
- Output Slope Control to eliminate Ground Bounce
- 100 kHz and 400 kHz Clock Compatibility
- Page Write Time 3 ms, typical
- Self-Timed Erase/Write Cycle
- 16-Byte Page Write Buffer
- Hardware Write-Protect for Half-Array (400h-7FFh)
- ESD Protection >4,000V
- More than 1 Million Erase/Write Cycles
- Data Retention >200 years
- Factory Programming available
- Packages include 8-lead PDIP, SOIC, TSSOP, TDFN, MSOP and 5-lead SOT-23
- Pb-Free and RoHS Compliant
- Temperature Ranges:
 - Industrial (I): -40°C to +85°C
 - Automotive (E): -40°C to +125°C

Description:

The Microchip Technology Inc. 24AA16H/24LC16BH (24XX16H*) is an 16 Kbit Electrically Erasable PROM. The device is organized as eight blocks of 256 x 8-bit memory with a 2-wire serial interface. Low-voltage design permits operation down to 1.7V, with standby and active currents of only 1 μ A and 1 mA, respectively. The 24XX16H also has a page write capability for up to 16 bytes of data. The 24XX16H is available in the standard 8-pin PDIP, surface mount SOIC, TSSOP, 2x3 TDFN and MSOP packages, and is also available in the 5-lead SOT-23 package. All packages are Pb-free and RoHS compliant.

Block Diagram



Package Types



*24XX16H is used in this document as a generic part number for the 24AA16H/24LC16BH devices.

24AA16H/24LC16BH

1.0 ELECTRICAL CHARACTERISTICS

Absolute Maximum Ratings ^(†)

| | |
|---|--------------------------------|
| V _{CC} | 6.5V |
| All inputs and outputs w.r.t. V _{SS} | -0.3V to V _{CC} +1.0V |
| Storage temperature | -65°C to +150°C |
| Ambient temperature with power applied..... | -40°C to +125°C |
| ESD protection on all pins | ≥ 4 kV |

† NOTICE: Stresses above those listed under “Absolute Maximum Ratings” may cause permanent damage to the device. This is a stress rating only and functional operation of the device at those or any other conditions above those indicated in the operational listings of this specification is not implied. Exposure to maximum rating conditions for extended periods may affect device reliability.

TABLE 1-1: DC CHARACTERISTICS

| DC CHARACTERISTICS | | | V _{CC} = +1.7V to +5.5V Industrial (I): T _A = -40°C to +85°C Automotive (E): T _A = -40°C to +125°C | | | | |
|--------------------|---------------------------------------|---|---|------|---------------------|-------|---|
| Param. No. | Symbol | Characteristic | Min. | Typ. | Max. | Units | Conditions |
| D1 | V _{IH} | WP, SCL and SDA pins | — | — | — | — | — |
| D2 | — | High-level input voltage | 0.7 V _{CC} | — | — | V | — |
| D3 | V _{IL} | Low-level input voltage | — | — | 0.3 V _{CC} | V | — |
| D4 | V _{HYS} | Hysteresis of Schmitt Trigger inputs | 0.05 V _{CC} | — | — | V | (Note) |
| D5 | V _{OL} | Low-level output voltage | — | — | 0.40 | V | I _{OL} = 3.0 mA, V _{CC} = 2.5V |
| D6 | I _{LI} | Input leakage current | — | — | ±1 | μA | V _{IN} = V _{SS} or V _{CC} |
| D7 | I _{LO} | Output leakage current | — | — | ±1 | μA | V _{OUT} = V _{SS} or V _{CC} |
| D8 | C _{IN} , C _{OUT} | Pin capacitance (all inputs/outputs) | — | — | 10 | pF | V _{CC} = 5.0V (Note) T _A = 25°C, F _{CLK} = 1 MHz |
| D9 | I _{CC} write | Operating current | — | 0.1 | 3 | mA | V _{CC} = 5.5V, SCL = 400 kHz |
| D10 | I _{CC} read | | — | 0.05 | 1 | mA | — |
| D11 | I _{CCS} | Standby current | — | 0.01 | 1 | μA | Industrial Automotive SDA = SCL = V _{CC} WP = V _{SS} |
| | | | — | — | 5 | μA | |

Note: This parameter is periodically sampled and not 100% tested.

24AA16H/24LC16BH

TABLE 1-2: AC CHARACTERISTICS

| AC CHARACTERISTICS | | | Industrial (I): TA = -40°C to +85°C, VCC = +1.7V to +5.5V Automotive (E): TA = -40°C to +125°C, VCC = +2.5V to +5.5V | | | |
|--------------------|---------|--|---|------|--------|-----------------------------|
| Param. No. | Symbol | Characteristic | Min. | Max. | Units | Conditions |
| 1 | FCLK | Clock Frequency | — | 400 | kHz | 2.5V ≤ VCC ≤ 5.5V |
| | | | — | 100 | kHz | 1.7V ≤ VCC < 2.5V (24AA16H) |
| 2 | THIGH | Clock High Time | 600 | — | ns | 2.5V ≤ VCC ≤ 5.5V |
| | | | 4000 | — | ns | 1.7V ≤ VCC < 2.5V (24AA16H) |
| 3 | TLOW | Clock Low Time | 1300 | — | ns | 2.5V ≤ VCC ≤ 5.5V |
| | | | 4700 | — | ns | 1.7V ≤ VCC < 2.5V (24AA16H) |
| 4 | TR | SDA and SCL Rise Time (Note 1) | — | 300 | ns | 2.5V ≤ VCC ≤ 5.5V |
| | | | — | 1000 | ns | 1.7V ≤ VCC < 2.5V (24AA16H) |
| 5 | TF | SDA and SCL Fall Time | — | 300 | ns | (Note 1) |
| 6 | THD:STA | Start Condition Hold Time | 600 | — | ns | 2.5V ≤ VCC ≤ 5.5V |
| | | | 4000 | — | ns | 1.7V ≤ VCC < 2.5V (24AA16H) |
| 7 | TSU:STA | Start Condition Setup Time | 600 | — | ns | 2.5V ≤ VCC ≤ 5.5V |
| | | | 4700 | — | ns | 1.7V ≤ VCC < 2.5V (24AA16H) |
| 8 | THD:DAT | Data Input Hold Time | 0 | — | ns | (Note 2) |
| 9 | TSU:DAT | Data Input Setup Time | 100 | — | ns | 2.5V ≤ VCC ≤ 5.5V |
| | | | 250 | — | ns | 1.7V ≤ VCC < 2.5V (24AA16H) |
| 10 | TSU:STO | Stop Condition Setup Time | 600 | — | ns | 2.5V ≤ VCC ≤ 5.5V |
| | | | 4000 | — | ns | 1.7V ≤ VCC < 2.5V (24AA16H) |
| 11 | TSU:WP | WP Setup Time | 600 | — | ns | 2.5V ≤ VCC ≤ 5.5V |
| | | | 4000 | — | ns | 1.7V ≤ VCC < 2.5V (24AA16H) |
| 12 | THD:WP | WP Hold Time | 1300 | — | ns | 2.5V ≤ VCC ≤ 5.5V |
| | | | 4700 | — | ns | 1.7V ≤ VCC < 2.5V (24AA16H) |
| 13 | TAA | Output Valid from Clock (Note 2) | — | 900 | ns | 2.5V ≤ VCC ≤ 5.5V |
| | | | — | 3500 | ns | 1.7V ≤ VCC < 2.5V (24AA16H) |
| 14 | TBUF | Bus free time: Time the bus must be free before a new transmission can start | 1300 | — | ns | 2.5V ≤ VCC ≤ 5.5V |
| | | | 4700 | — | ns | 1.7V ≤ VCC < 2.5V (24AA16H) |
| 15 | TOF | Output Fall Time from VIH Minimum to VIL Maximum | — | 250 | ns | 2.5V ≤ VCC ≤ 5.5V |
| | | | — | 250 | ns | 1.7V ≤ VCC < 2.5V (24AA16H) |
| 16 | TSP | Input Filter Spike Suppression (SDA and SCL pins) | — | 50 | ns | (Notes 1 and 3) |
| 17 | TWC | Write Cycle Time (byte or page) | — | 5 | ms | — |
| 18 | — | Endurance | 1M | — | cycles | 25°C, (Note 4) |

Note 1: Not 100% tested. CB = total capacitance of one bus line in pF.

- 2:** As a transmitter the device must provide an internal minimum delay time to bridge the undefined region (minimum 300 ns) of the falling edge of SCL to avoid unintended generation of Start or Stop conditions.
- 3:** The combined TSP and VHYS specifications are due to new Schmitt Trigger inputs which provide improved noise spike suppression. This eliminates the need for a T1 specification for standard operation.
- 4:** This parameter is not tested but ensured by characterization. For endurance estimates in a specific application, please consult the Total Endurance™ Model which can be obtained on Microchip's web site at www.microchip.com.

24AA16H/24LC16BH

FIGURE 1-1: BUS TIMING DATA

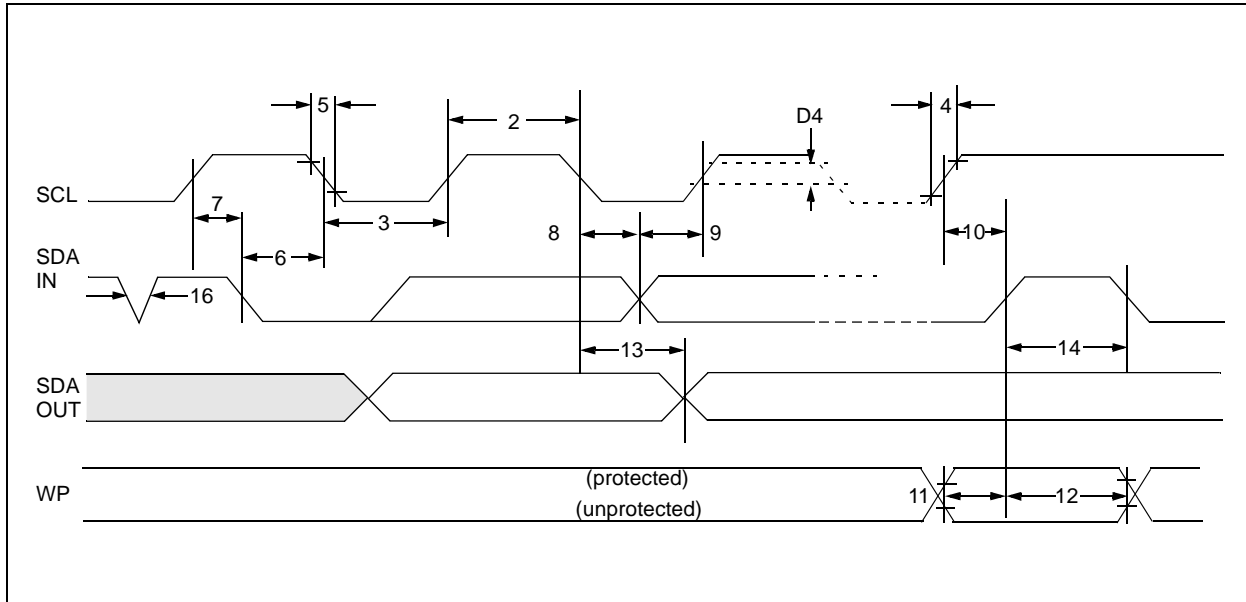

2.0 FUNCTIONAL DESCRIPTION

The 24XX16H supports a bidirectional, 2-wire bus and data transmission protocol. A device that sends data onto the bus is defined as a transmitter, while a device receiving data is defined as a receiver. The bus has to be controlled by a master device which generates the Serial Clock (SCL), controls the bus access and generates the Start and Stop conditions, while the 24XX16H works as slave. Both master and slave can operate as transmitter or receiver, but the master device determines which mode is activated.

3.0 BUS CHARACTERISTICS

The following **bus protocol** has been defined:

- Data transfer may be initiated only when the bus is not busy.
- During data transfer, the data line must remain stable whenever the clock line is high. Changes in the data line while the clock line is high will be interpreted as a Start or Stop condition.

Accordingly, the following bus conditions have been defined (Figure 3-1).

3.1 Bus Not Busy (A)

Both data and clock lines remain high.

3.2 Start Data Transfer (B)

A high-to-low transition of the SDA line while the clock (SCL) is high determines a Start condition. All commands must be preceded by a Start condition.

3.3 Stop Data Transfer (C)

A low-to-high transition of the SDA line while the clock (SCL) is high determines a Stop condition. All operations must be ended with a Stop condition.

3.4 Data Valid (D)

The state of the data line represents valid data when, after a Start condition, the data line is stable for the duration of the high period of the clock signal.

The data on the line must be changed during the low period of the clock signal. There is one clock pulse per bit of data.

Each data transfer is initiated with a Start condition and terminated with a Stop condition. The number of the data bytes transferred between the Start and Stop conditions is determined by the master device and is theoretically unlimited, although only the last sixteen will be stored when doing a write operation. When an overwrite does occur it will replace data in a first-in first-out (FIFO) fashion.

3.5 Acknowledge

Each receiving device, when addressed, is obliged to generate an acknowledge after the reception of each byte. The master device must generate an extra clock pulse which is associated with this Acknowledge bit.

Note: The 24XX16H does not generate any Acknowledge bits if an internal programming cycle is in progress.

The device that acknowledges, has to pull down the SDA line during the acknowledge clock pulse in such a way that the SDA line is stable low during the high period of the acknowledge related clock pulse. Of course, setup and hold times must be taken into account. During reads, a master must signal an end of data to the slave by not generating an Acknowledge bit on the last byte that has been clocked out of the slave. In this case, the slave (24XX16H) will leave the data line high to enable the master to generate the Stop condition.

FIGURE 3-1: DATA TRANSFER SEQUENCE ON THE SERIAL BUS

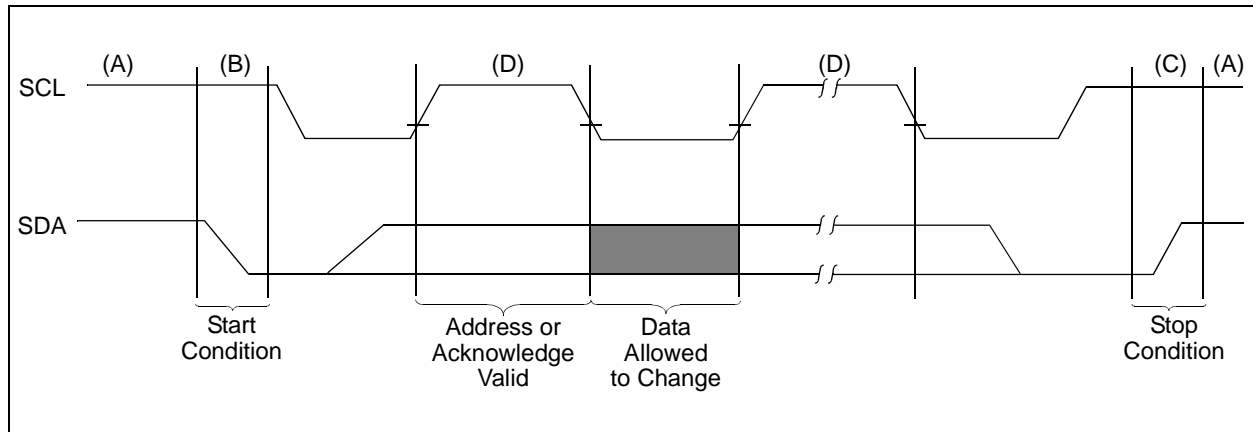

24AA16H/24LC16BH

3.6 Device Addressing

A control byte is the first byte received following the Start condition from the master device (Figure 3-2). The control byte consists of a four-bit control code. For the 24XX16H, this is set as '1010' binary for read and write operations. The next three bits of the control byte are the block-select bits (B2, B1, B0). They are used by the master device to select which of the eight 256 word-blocks of memory are to be accessed. These bits are in effect the three Most Significant bits of the word address.

The last bit of the control byte defines the operation to be performed. When set to '1' a read operation is selected. When set to '0' a write operation is selected. Following the Start condition, the 24XX16H monitors the SDA bus, checking the device type identifier being transmitted and, upon receiving a '1010' code, the slave device outputs an Acknowledge signal on the SDA line. Depending on the state of the R/W bit, the 24XX16H will select a read or write operation.

| Operation | Control Code | Block Select | R/W |
|-----------|--------------|---------------|-----|
| Read | 1010 | Block Address | 1 |
| Write | 1010 | Block Address | 0 |

FIGURE 3-2: CONTROL BYTE ALLOCATION



4.0 WRITE OPERATION

4.1 Byte Write

Following the Start condition from the master, the device code (4 bits), the block address (3 bits) and the R/W bit, which is a logic-low, is placed onto the bus by the master transmitter. This indicates to the addressed slave receiver that a byte with a word address will follow once it has generated an Acknowledge bit during the ninth clock cycle. Therefore, the next byte transmitted by the master is the word address and will be written into the Address Pointer of the 24XX16H. After receiving another Acknowledge signal from the 24XX16H, the master device will transmit the data word to be written into the addressed memory location. The 24XX16H acknowledges again and the master generates a Stop condition. This initiates the internal write cycle and, during this time, the 24XX16H will not generate Acknowledge signals (Figure 4-1).

4.2 Page Write

The write control byte, word address and the first data byte are transmitted to the 24XX16H in the same way as in a byte write. However, instead of generating a Stop condition, the master transmits up to 16 data bytes to the 24XX16H, which are temporarily stored in the on-chip page buffer and will be written into memory once the master has transmitted a Stop condition. Upon receipt of each word, the four lower-order Address Pointer bits are internally incremented by '1'. The higher-order 7 bits of the word address remain constant. If the master should transmit more than 16 words prior to generating the Stop condition, the address counter will roll over and the previously received data will be overwritten. As with the byte write operation, once the Stop condition is received an internal write cycle will begin (Figure 4-2).

Note: Page write operations are limited to writing bytes within a single physical page, **regardless** of the number of bytes actually being written. Physical page boundaries start at addresses that are integer multiples of the page buffer size (or 'page-size') and end at addresses that are integer multiples of [page size - 1]. If a Page Write command attempts to write across a physical page boundary, the result is that the data wraps around to the beginning of the current page (overwriting data previously stored there), instead of being written to the next page, as might be expected. It is therefore necessary for the application software to prevent page write operations that would attempt to cross a page boundary.

FIGURE 4-1: BYTE WRITE



FIGURE 4-2: PAGE WRITE



24AA16H/24LC16BH

5.0 ACKNOWLEDGE POLLING

Since the device will not acknowledge during a write cycle, this can be used to determine when the cycle is complete (this feature can be used to maximize bus throughput). Once the Stop condition for a Write command has been issued from the master, the device initiates the internally-timed write cycle and ACK polling can then be initiated immediately. This involves the master sending a Start condition followed by the control byte for a Write command ($R/\overline{W} = 0$). If the device is still busy with the write cycle, no ACK will be returned. If the cycle is complete, the device will return the ACK and the master can then proceed with the next Read or Write command. See Figure 5-1 for a flow diagram of this operation.

6.0 WRITE PROTECTION

The WP pin allows the user to write-protect half of the array (400h-7FFh) when the pin is tied to VCC. If the pin is tied to VSS the write protection is disabled.

FIGURE 5-1: ACKNOWLEDGE POLLING FLOW



7.0 READ OPERATION

Read operations are initiated in the same way as write operations, with the exception that the R/\overline{W} bit of the slave address is set to '1'. There are three basic types of read operations: current address read, random read and sequential read.

7.1 Current Address Read

The 24XX16H contains an address counter that maintains the address of the last word accessed, internally incremented by '1'. Therefore, if the previous access (either a read or write operation) was to address n , the next current address read operation would access data from address $n + 1$. Upon receipt of the slave address with R/\overline{W} bit set to '1', the 24XX16H issues an acknowledge and transmits the 8-bit data word. The master will not acknowledge the transfer, but does generate a Stop condition and the 24XX16H discontinues transmission (Figure 7-1).

7.2 Random Read

Random read operations allow the master to access any memory location in a random manner. To perform this type of read operation, the word address must first be set. This is accomplished by sending the word address to the 24XX16H as part of a write operation. Once the word address is sent, the master generates a Start condition following the acknowledge. This terminates the write operation, but not before the internal Address Pointer is set. The master then issues the control byte again, but with the R/\overline{W} bit set to a '1'. The 24XX16H will then issue an acknowledge and transmit the 8-bit data word. The master will not acknowledge the transfer, but does generate a Stop condition and the 24XX16H will discontinue transmission (Figure 7-2).

7.3 Sequential Read

Sequential reads are initiated in the same way as a random read, except that once the 24XX16H transmits the first data byte, the master issues an acknowledge as opposed to a Stop condition in a random read. This directs the 24XX16H to transmit the next sequentially-addressed 8-bit word (Figure 7-3).

To provide sequential reads, the 24XX16H contains an internal Address Pointer that is incremented by one upon completion of each operation. This Address Pointer allows the entire memory contents to be serially read during one operation.

7.4 Noise Protection

The 24XX16H employs a V_{CC} threshold detector circuit which disables the internal erase/write logic if the V_{CC} is below 1.5V at nominal conditions.

The SCL and SDA inputs have Schmitt Trigger and filter circuits which suppress noise spikes to assure proper device operation, even on a noisy bus.

FIGURE 7-1: CURRENT ADDRESS READ



24AA16H/24LC16BH

FIGURE 7-2: RANDOM READ



FIGURE 7-3: SEQUENTIAL READ



8.0 PIN DESCRIPTIONS

The descriptions of the pins are listed in Table 8-1.

TABLE 8-1: PIN FUNCTION TABLE

| Name | PDIP | SOIC | TSSOP | TDFN | MSOP | SOT-23 | Description |
|------|------|------|-------|------|------|--------|----------------------------|
| A0 | 1 | 1 | 1 | 1 | 1 | — | Not Connected |
| A1 | 2 | 2 | 2 | 2 | 2 | — | Not Connected |
| A2 | 3 | 3 | 3 | 3 | 3 | — | Not Connected |
| Vss | 4 | 4 | 4 | 4 | 4 | 2 | Ground |
| SDA | 5 | 5 | 5 | 5 | 5 | 3 | Serial Address/Data I/O |
| SCL | 6 | 6 | 6 | 6 | 6 | 1 | Serial Clock |
| WP | 7 | 7 | 7 | 7 | 7 | 5 | Write-Protect Input |
| Vcc | 8 | 8 | 8 | 8 | 8 | 4 | +1.7V to 5.5V Power Supply |

8.1 Serial Address/Data Input/Output (SDA)

SDA is a bidirectional pin used to transfer addresses and data into and out of the device. Since it is an open-drain terminal, the SDA bus requires a pull-up resistor to Vcc (typical 10 kΩ for 100 kHz, 2 kΩ for 400 kHz).

For normal data transfer, SDA is allowed to change only during SCL low. Changes during SCL high are reserved for indicating Start and Stop conditions.

8.2 Serial Clock (SCL)

The SCL input is used to synchronize the data transfer to and from the device.

8.3 Write-Protect (WP)

The WP pin must be connected to either Vss or Vcc.

If tied to Vss, normal memory operation is enabled (read/write the entire memory 000h-7FFh).

If tied to Vcc, write operations are inhibited, half of the memory will be write-protected (400h-7FFh). Read operations are not affected.

8.4 A0, A1, A2

The A0, A1 and A2 pins are not used by the 24XX16H. They may be left floating or tied to either Vss or Vcc.

24AA16H/24LC16BH

9.0 PACKAGING INFORMATION

9.1 Package Marking Information

8-Lead PDIP (300 mil)

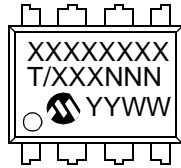

Example:



8-Lead SOIC (3.90 mm)

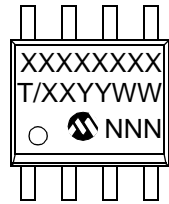

Example:

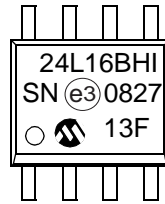

8-Lead TSSOP



Example:

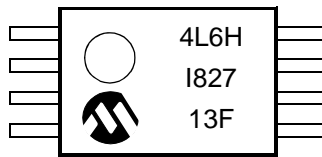

8-Lead MSOP



Example:



5-Lead SOT-23

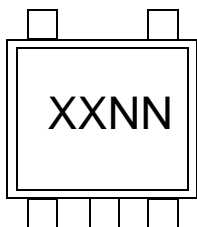

Example:



8-Lead 2x3 TDFN



Example:

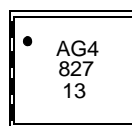

24AA16H/24LC16BH

| 1st Line Marking | | | | | | | |
|------------------|-------|--------|--------|--------|--------|--------|--------|
| Part No. | TSSOP | MSOP | | SOT-23 | | TDFN | |
| | | I-Temp | E-Temp | I-Temp | E-Temp | I-Temp | E-Temp |
| 24AA16H | 4A6H | 4A16HI | — | BWNN | — | AG1 | — |
| 24LC16BH | 4L6H | 4L16HI | 4L16HE | 5QNN | 5RNN | AG4 | AS5 |

Legend: XX...X Part number or part number code
T Temperature (I, E)
Y Year code (last digit of calendar year)
YY Year code (last 2 digits of calendar year)
WW Week code (week of January 1 is week '01')
NNN Alphanumeric traceability code (2 characters for small packages)
ⓔ3 Pb-free JEDEC designator for Matte Tin (Sn)

Note: For very small packages with no room for the Pb-free JEDEC designator ⓔ3, the marking will only appear on the outer carton or reel label.

Note: In the event the full Microchip part number cannot be marked on one line, it will be carried over to the next line, thus limiting the number of available characters for customer-specific information.

*Standard OTP marking consists of Microchip part number, year code, week code, and traceability code.

24AA16H/24LC16BH

8-Lead Plastic Dual In-Line (P) – 300 mil Body [PDIP]

Note: For the most current package drawings, please see the Microchip Packaging Specification located at <http://www.microchip.com/packaging>



| Dimension Limits | Units | INCHES | | |
|----------------------------|-------|----------|------|------|
| | | MIN | NOM | MAX |
| Number of Pins | N | 8 | | |
| Pitch | e | .100 BSC | | |
| Top to Seating Plane | A | – | – | .210 |
| Molded Package Thickness | A2 | .115 | .130 | .195 |
| Base to Seating Plane | A1 | .015 | – | – |
| Shoulder to Shoulder Width | E | .290 | .310 | .325 |
| Molded Package Width | E1 | .240 | .250 | .280 |
| Overall Length | D | .348 | .365 | .400 |
| Tip to Seating Plane | L | .115 | .130 | .150 |
| Lead Thickness | c | .008 | .010 | .015 |
| Upper Lead Width | b1 | .040 | .060 | .070 |
| Lower Lead Width | b | .014 | .018 | .022 |
| Overall Row Spacing § | eB | – | – | .430 |

Notes:

- Pin 1 visual index feature may vary, but must be located with the hatched area.
- § Significant Characteristic.
- Dimensions D and E1 do not include mold flash or protrusions. Mold flash or protrusions shall not exceed .010" per side.
- Dimensioning and tolerancing per ASME Y14.5M.

BSC: Basic Dimension. Theoretically exact value shown without tolerances.

Microchip Technology Drawing C04-018B

8-Lead Plastic Small Outline (SN) – Narrow, 3.90 mm Body [SOIC]

Note: For the most current package drawings, please see the Microchip Packaging Specification located at <http://www.microchip.com/packaging>



| | | Units | MILLIMETERS | | |
|--------------------------|----------|-------|-------------|-----|------|
| Dimension Limits | | | MIN | NOM | MAX |
| Number of Pins | N | | 8 | | |
| Pitch | e | | 1.27 BSC | | |
| Overall Height | A | | – | – | 1.75 |
| Molded Package Thickness | A2 | | 1.25 | – | – |
| Standoff § | A1 | | 0.10 | – | 0.25 |
| Overall Width | E | | 6.00 BSC | | |
| Molded Package Width | E1 | | 3.90 BSC | | |
| Overall Length | D | | 4.90 BSC | | |
| Chamfer (optional) | h | | 0.25 | – | 0.50 |
| Foot Length | L | | 0.40 | – | 1.27 |
| Footprint | L1 | | 1.04 REF | | |
| Foot Angle | ϕ | | 0° | – | 8° |
| Lead Thickness | c | | 0.17 | – | 0.25 |
| Lead Width | b | | 0.31 | – | 0.51 |
| Mold Draft Angle Top | α | | 5° | – | 15° |
| Mold Draft Angle Bottom | β | | 5° | – | 15° |

Notes:

1. Pin 1 visual index feature may vary, but must be located within the hatched area.
2. § Significant Characteristic.
3. Dimensions D and E1 do not include mold flash or protrusions. Mold flash or protrusions shall not exceed 0.15 mm per side.
4. Dimensioning and tolerancing per ASME Y14.5M.

BSC: Basic Dimension. Theoretically exact value shown without tolerances.

REF: Reference Dimension, usually without tolerance, for information purposes only.

Microchip Technology Drawing C04-057B

24AA16H/24LC16BH

8-Lead Plastic Small Outline (SN) – Narrow, 3.90 mm Body [SOIC]

Note: For the most current package drawings, please see the Microchip Packaging Specification located at <http://www.microchip.com/packaging>



RECOMMENDED LAND PATTERN

| Units | | MILLIMETERS | | |
|-------------------------|----|-------------|------|------|
| Dimension Limits | | MIN | NOM | MAX |
| Contact Pitch | E | 1.27 BSC | | |
| Contact Pad Spacing | C | | 5.40 | |
| Contact Pad Width (X8) | X1 | | | 0.60 |
| Contact Pad Length (X8) | Y1 | | | 1.55 |

Notes:

1. Dimensioning and tolerancing per ASME Y14.5M

BSC: Basic Dimension. Theoretically exact value shown without tolerances.

Microchip Technology Drawing No. C04-2057A

8-Lead Plastic Thin Shrink Small Outline (ST) – 4.4 mm Body [TSSOP]

Note: For the most current package drawings, please see the Microchip Packaging Specification located at <http://www.microchip.com/packaging>



| Dimension Limits | Units | MILLIMETERS | | |
|--------------------------|--------|-------------|------|------|
| | | MIN | NOM | MAX |
| Number of Pins | N | 8 | | |
| Pitch | e | 0.65 BSC | | |
| Overall Height | A | – | – | 1.20 |
| Molded Package Thickness | A2 | 0.80 | 1.00 | 1.05 |
| Standoff | A1 | 0.05 | – | 0.15 |
| Overall Width | E | 6.40 BSC | | |
| Molded Package Width | E1 | 4.30 | 4.40 | 4.50 |
| Molded Package Length | D | 2.90 | 3.00 | 3.10 |
| Foot Length | L | 0.45 | 0.60 | 0.75 |
| Footprint | L1 | 1.00 REF | | |
| Foot Angle | ϕ | 0° | – | 8° |
| Lead Thickness | c | 0.09 | – | 0.20 |
| Lead Width | b | 0.19 | – | 0.30 |

Notes:

1. Pin 1 visual index feature may vary, but must be located within the hatched area.
2. Dimensions D and E1 do not include mold flash or protrusions. Mold flash or protrusions shall not exceed 0.15 mm per side.
3. Dimensioning and tolerancing per ASME Y14.5M.

BSC: Basic Dimension. Theoretically exact value shown without tolerances.

REF: Reference Dimension, usually without tolerance, for information purposes only.

Microchip Technology Drawing C04-086B

24AA16H/24LC16BH

8-Lead Plastic Micro Small Outline Package (MS) [MSOP]

Note: For the most current package drawings, please see the Microchip Packaging Specification located at <http://www.microchip.com/packaging>



| Dimension Limits | Units | MILLIMETERS | | |
|--------------------------|--------|-------------|------|------|
| | | MIN | NOM | MAX |
| Number of Pins | N | 8 | | |
| Pitch | e | 0.65 BSC | | |
| Overall Height | A | - | - | 1.10 |
| Molded Package Thickness | A2 | 0.75 | 0.85 | 0.95 |
| Standoff | A1 | 0.00 | - | 0.15 |
| Overall Width | E | 4.90 BSC | | |
| Molded Package Width | E1 | 3.00 BSC | | |
| Overall Length | D | 3.00 BSC | | |
| Foot Length | L | 0.40 | 0.60 | 0.80 |
| Footprint | L1 | 0.95 REF | | |
| Foot Angle | ϕ | 0° | - | 8° |
| Lead Thickness | c | 0.08 | - | 0.23 |
| Lead Width | b | 0.22 | - | 0.40 |

Notes:

- Pin 1 visual index feature may vary, but must be located within the hatched area.
- Dimensions D and E1 do not include mold flash or protrusions. Mold flash or protrusions shall not exceed 0.15 mm per side.
- Dimensioning and tolerancing per ASME Y14.5M.

BSC: Basic Dimension. Theoretically exact value shown without tolerances.

REF: Reference Dimension, usually without tolerance, for information purposes only.

Microchip Technology Drawing C04-111B

5-Lead Plastic Small Outline Transistor (OT) [SOT-23]

Note: For the most current package drawings, please see the Microchip Packaging Specification located at <http://www.microchip.com/packaging>



| Dimension Limits | Units | MILLIMETERS | | |
|--------------------------|--------|-------------|-----|------|
| | | MIN | NOM | MAX |
| Number of Pins | N | 5 | | |
| Lead Pitch | e | 0.95 BSC | | |
| Outside Lead Pitch | e1 | 1.90 BSC | | |
| Overall Height | A | 0.90 | – | 1.45 |
| Molded Package Thickness | A2 | 0.89 | – | 1.30 |
| Standoff | A1 | 0.00 | – | 0.15 |
| Overall Width | E | 2.20 | – | 3.20 |
| Molded Package Width | E1 | 1.30 | – | 1.80 |
| Overall Length | D | 2.70 | – | 3.10 |
| Foot Length | L | 0.10 | – | 0.60 |
| Footprint | L1 | 0.35 | – | 0.80 |
| Foot Angle | ϕ | 0° | – | 30° |
| Lead Thickness | c | 0.08 | – | 0.26 |
| Lead Width | b | 0.20 | – | 0.51 |

Notes:

- Dimensions D and E1 do not include mold flash or protrusions. Mold flash or protrusions shall not exceed 0.127 mm per side.
- Dimensioning and tolerancing per ASME Y14.5M.

BSC: Basic Dimension. Theoretically exact value shown without tolerances.

Microchip Technology Drawing C04-091B

24AA16H/24LC16BH

8-Lead Plastic Dual Flat, No Lead Package (MN) – 2x3x0.75 mm Body [TDFN]

Note: For the most current package drawings, please see the Microchip Packaging Specification located at <http://www.microchip.com/packaging>



| Dimension Limits | Units | MILLIMETERS | | |
|------------------------|-------|-------------|------|------|
| | | MIN | NOM | MAX |
| Number of Pins | N | 8 | | |
| Pitch | e | 0.50 BSC | | |
| Overall Height | A | 0.70 | 0.75 | 0.80 |
| Standoff | A1 | 0.00 | 0.02 | 0.05 |
| Contact Thickness | A3 | 0.20 REF | | |
| Overall Length | D | 2.00 BSC | | |
| Overall Width | E | 3.00 BSC | | |
| Exposed Pad Length | D2 | 1.20 | - | 1.60 |
| Exposed Pad Width | E2 | 1.20 | - | 1.60 |
| Contact Width | b | 0.20 | 0.25 | 0.30 |
| Contact Length | L | 0.25 | 0.30 | 0.45 |
| Contact-to-Exposed Pad | K | 0.20 | - | - |

Notes:

- Pin 1 visual index feature may vary, but must be located within the hatched area.
- Package may have one or more exposed tie bars at ends.
- Package is saw singulated
- Dimensioning and tolerancing per ASME Y14.5M

BSC: Basic Dimension. Theoretically exact value shown without tolerances.

REF: Reference Dimension, usually without tolerance, for information purposes only.

Microchip Technology Drawing No. C04-129B

8-Lead Plastic Dual Flat, No Lead Package (MN) – 2x3x0.75 mm Body [TDFN]

Note: For the most current package drawings, please see the Microchip Packaging Specification located at <http://www.microchip.com/packaging>



| | | MILLIMETERS | | |
|----------------------------|----|-------------|------|------|
| | | MIN | NOM | MAX |
| Contact Pitch | E | 0.50 BSC | | |
| Optional Center Pad Width | W2 | | | 1.46 |
| Optional Center Pad Length | T2 | | | 1.36 |
| Contact Pad Spacing | C1 | | 3.00 | |
| Contact Pad Width (X8) | X1 | | | 0.30 |
| Contact Pad Length (X8) | Y1 | | | 0.75 |
| Distance Between Pads | G | 0.20 | | |

Notes:

1. Dimensioning and tolerancing per ASME Y14.5M

BSC: Basic Dimension. Theoretically exact value shown without tolerances.

Microchip Technology Drawing No. C04-2129A

24AA16H/24LC16BH

APPENDIX A: REVISION HISTORY

Revision A (11/2008)

Original release.

THE MICROCHIP WEB SITE

Microchip provides online support via our WWW site at www.microchip.com. This web site is used as a means to make files and information easily available to customers. Accessible by using your favorite Internet browser, the web site contains the following information:

- **Product Support** – Data sheets and errata, application notes and sample programs, design resources, user's guides and hardware support documents, latest software releases and archived software
- **General Technical Support** – Frequently Asked Questions (FAQ), technical support requests, online discussion groups, Microchip consultant program member listing
- **Business of Microchip** – Product selector and ordering guides, latest Microchip press releases, listing of seminars and events, listings of Microchip sales offices, distributors and factory representatives

CUSTOMER CHANGE NOTIFICATION SERVICE

Microchip's customer notification service helps keep customers current on Microchip products. Subscribers will receive e-mail notification whenever there are changes, updates, revisions or errata related to a specified product family or development tool of interest.

To register, access the Microchip web site at www.microchip.com, click on Customer Change Notification and follow the registration instructions.

CUSTOMER SUPPORT

Users of Microchip products can receive assistance through several channels:

- Distributor or Representative
- Local Sales Office
- Field Application Engineer (FAE)
- Technical Support
- Development Systems Information Line

Customers should contact their distributor, representative or field application engineer (FAE) for support. Local sales offices are also available to help customers. A listing of sales offices and locations is included in the back of this document.

Technical support is available through the web site at: <http://support.microchip.com>

24AA16H/24LC16BH

READER RESPONSE

It is our intention to provide you with the best documentation possible to ensure successful use of your Microchip product. If you wish to provide your comments on organization, clarity, subject matter, and ways in which our documentation can better serve you, please FAX your comments to the Technical Publications Manager at (480) 792-4150.

Please list the following information, and use this outline to provide us with your comments about this document.

To: Technical Publications Manager
RE: Reader Response
Total Pages Sent _____

From: Name _____
Company _____
Address _____
City / State / ZIP / Country _____
Telephone: (_____) _____ - _____ FAX: (_____) _____ - _____

Application (optional):

Would you like a reply? ___Y ___N

Device: 24AA16H/24LC16BH Literature Number: DS22118A

Questions:

1. What are the best features of this document?

2. How does this document meet your hardware and software development needs?

3. Do you find the organization of this document easy to follow? If not, why?

4. What additions to the document do you think would enhance the structure and subject?

5. What deletions from the document could be made without affecting the overall usefulness?

6. Is there any incorrect or misleading information (what and where)?

7. How would you improve this document?

PRODUCT IDENTIFICATION SYSTEM

To order or obtain information, e.g., on pricing or delivery, refer to the factory or the listed sales office.

| <u>PART NO.</u> | <u>X</u> | <u>/XX</u> | Examples: |
|--|-------------------|------------|---|
| Device | Temperature Range | Package | |
| <p>Device:</p> <p>24AA16H = 1.7V, 16 Kbit I²C Serial EEPROM 24AA16HT = 1.7V, 16 Kbit I²C Serial EEPROM (Tape and Reel) 24LC16BH = 2.5V, 16 Kbit I²C Serial EEPROM 24LC16BHT= 2.5V, 16 Kbit I²C Serial EEPROM (Tape and Reel)</p> <p>Temperature Range:</p> <p>I = -40°C to +85°C E = -40°C to +125°C</p> <p>Package:</p> <p>P = Plastic DIP (300 mil body), 8-lead SN = Plastic SOIC (3.90 mm body), 8-lead ST = Plastic TSSOP (4.4 mm), 8-lead MNY⁽¹⁾ = Plastic Dual Flat (TDFN), No lead package, 2x3 mm body, 8-lead MS = Plastic Micro Small Outline (MSOP), 8-lead OT = SOT-23, 5-lead (Tape and Reel only)</p> <p>Note 1: "Y" indicates a Nickel Palladium Gold (NiPdAu) finish.</p> | | | <p>a) 24AA16H-I/P: Industrial Temperature, 1.7V, PDIP package</p> <p>b) 24AA16H-I/SN: Industrial Temperature, 1.7V, SOIC package</p> <p>c) 24AA16HT-I/OT: Industrial Temperature, 1.7V, SOT-23 package, Tape and Reel</p> <p>d) 24LC16BH-I/P: Industrial Temperature, 2.5V, PDIP package</p> <p>e) 24LC16BH-E/SN: Automotive Temp., 2.5V SOIC package</p> <p>f) 24LC16BHT-I/OT: Industrial Temperature, 2.5V, SOT-23 package, Tape and Reel</p> |

24AA16H/24LC16BH

NOTES:

Note the following details of the code protection feature on Microchip devices:

- Microchip products meet the specification contained in their particular Microchip Data Sheet.
- Microchip believes that its family of products is one of the most secure families of its kind on the market today, when used in the intended manner and under normal conditions.
- There are dishonest and possibly illegal methods used to breach the code protection feature. All of these methods, to our knowledge, require using the Microchip products in a manner outside the operating specifications contained in Microchip's Data Sheets. Most likely, the person doing so is engaged in theft of intellectual property.
- Microchip is willing to work with the customer who is concerned about the integrity of their code.
- Neither Microchip nor any other semiconductor manufacturer can guarantee the security of their code. Code protection does not mean that we are guaranteeing the product as "unbreakable."

Code protection is constantly evolving. We at Microchip are committed to continuously improving the code protection features of our products. Attempts to break Microchip's code protection feature may be a violation of the Digital Millennium Copyright Act. If such acts allow unauthorized access to your software or other copyrighted work, you may have a right to sue for relief under that Act.

Information contained in this publication regarding device applications and the like is provided only for your convenience and may be superseded by updates. It is your responsibility to ensure that your application meets with your specifications. MICROCHIP MAKES NO REPRESENTATIONS OR WARRANTIES OF ANY KIND WHETHER EXPRESS OR IMPLIED, WRITTEN OR ORAL, STATUTORY OR OTHERWISE, RELATED TO THE INFORMATION, INCLUDING BUT NOT LIMITED TO ITS CONDITION, QUALITY, PERFORMANCE, MERCHANTABILITY OR FITNESS FOR PURPOSE. Microchip disclaims all liability arising from this information and its use. Use of Microchip devices in life support and/or safety applications is entirely at the buyer's risk, and the buyer agrees to defend, indemnify and hold harmless Microchip from any and all damages, claims, suits, or expenses resulting from such use. No licenses are conveyed, implicitly or otherwise, under any Microchip intellectual property rights.

Trademarks

The Microchip name and logo, the Microchip logo, Accuron, dsPIC, KEELOQ, KEELOQ logo, MPLAB, PIC, PICmicro, PICSTART, rfPIC, SmartShunt and UNI/O are registered trademarks of Microchip Technology Incorporated in the U.S.A. and other countries.

FilterLab, Linear Active Thermistor, MXDEV, MXLAB, SEEVAL, SmartSensor and The Embedded Control Solutions Company are registered trademarks of Microchip Technology Incorporated in the U.S.A.

Analog-for-the-Digital Age, Application Maestro, CodeGuard, dsPICDEM, dsPICDEM.net, dsPICworks, dsSPEAK, ECAN, ECONOMONITOR, FanSense, In-Circuit Serial Programming, ICSP, ICEPIC, Mindi, MiWi, MPASM, MPLAB Certified logo, MPLIB, MPLINK, mTouch, PICkit, PICDEM, PICDEM.net, PICtail, PIC³² logo, PowerCal, PowerInfo, PowerMate, PowerTool, REAL ICE, rLAB, Select Mode, Total Endurance, WiperLock and ZENA are trademarks of Microchip Technology Incorporated in the U.S.A. and other countries.

SQTP is a service mark of Microchip Technology Incorporated in the U.S.A.

All other trademarks mentioned herein are property of their respective companies.

© 2008, Microchip Technology Incorporated, Printed in the U.S.A., All Rights Reserved.

 Printed on recycled paper.

QUALITY MANAGEMENT SYSTEM
CERTIFIED BY DNV
== ISO/TS 16949:2002 ==

Microchip received ISO/TS-16949:2002 certification for its worldwide headquarters, design and wafer fabrication facilities in Chandler and Tempe, Arizona; Gresham, Oregon and design centers in California and India. The Company's quality system processes and procedures are for its PIC® MCUs and dsPIC® DSCs, KEELOQ® code hopping devices, Serial EEPROMs, microperipherals, nonvolatile memory and analog products. In addition, Microchip's quality system for the design and manufacture of development systems is ISO 9001:2000 certified.



WORLDWIDE SALES AND SERVICE

AMERICAS

Corporate Office
2355 West Chandler Blvd.
Chandler, AZ 85224-6199
Tel: 480-792-7200
Fax: 480-792-7277
Technical Support:
<http://support.microchip.com>
Web Address:
www.microchip.com

Atlanta
Duluth, GA
Tel: 678-957-9614
Fax: 678-957-1455

Boston
Westborough, MA
Tel: 774-760-0087
Fax: 774-760-0088

Chicago
Itasca, IL
Tel: 630-285-0071
Fax: 630-285-0075

Dallas
Addison, TX
Tel: 972-818-7423
Fax: 972-818-2924

Detroit
Farmington Hills, MI
Tel: 248-538-2250
Fax: 248-538-2260

Kokomo
Kokomo, IN
Tel: 765-864-8360
Fax: 765-864-8387

Los Angeles
Mission Viejo, CA
Tel: 949-462-9523
Fax: 949-462-9608

Santa Clara
Santa Clara, CA
Tel: 408-961-6444
Fax: 408-961-6445

Toronto
Mississauga, Ontario,
Canada
Tel: 905-673-0699
Fax: 905-673-6509

ASIA/PACIFIC

Asia Pacific Office
Suites 3707-14, 37th Floor
Tower 6, The Gateway
Harbour City, Kowloon
Hong Kong
Tel: 852-2401-1200
Fax: 852-2401-3431

Australia - Sydney
Tel: 61-2-9868-6733
Fax: 61-2-9868-6755

China - Beijing
Tel: 86-10-8528-2100
Fax: 86-10-8528-2104

China - Chengdu
Tel: 86-28-8665-5511
Fax: 86-28-8665-7889

China - Hong Kong SAR
Tel: 852-2401-1200
Fax: 852-2401-3431

China - Nanjing
Tel: 86-25-8473-2460
Fax: 86-25-8473-2470

China - Qingdao
Tel: 86-532-8502-7355
Fax: 86-532-8502-7205

China - Shanghai
Tel: 86-21-5407-5533
Fax: 86-21-5407-5066

China - Shenyang
Tel: 86-24-2334-2829
Fax: 86-24-2334-2393

China - Shenzhen
Tel: 86-755-8203-2660
Fax: 86-755-8203-1760

China - Wuhan
Tel: 86-27-5980-5300
Fax: 86-27-5980-5118

China - Xiamen
Tel: 86-592-2388138
Fax: 86-592-2388130

China - Xian
Tel: 86-29-8833-7252
Fax: 86-29-8833-7256

China - Zhuhai
Tel: 86-756-3210040
Fax: 86-756-3210049

ASIA/PACIFIC

India - Bangalore
Tel: 91-80-4182-8400
Fax: 91-80-4182-8422

India - New Delhi
Tel: 91-11-4160-8631
Fax: 91-11-4160-8632

India - Pune
Tel: 91-20-2566-1512
Fax: 91-20-2566-1513

Japan - Yokohama
Tel: 81-45-471- 6166
Fax: 81-45-471-6122

Korea - Daegu
Tel: 82-53-744-4301
Fax: 82-53-744-4302

Korea - Seoul
Tel: 82-2-554-7200
Fax: 82-2-558-5932 or
82-2-558-5934

Malaysia - Kuala Lumpur
Tel: 60-3-6201-9857
Fax: 60-3-6201-9859

Malaysia - Penang
Tel: 60-4-227-8870
Fax: 60-4-227-4068

Philippines - Manila
Tel: 63-2-634-9065
Fax: 63-2-634-9069

Singapore
Tel: 65-6334-8870
Fax: 65-6334-8850

Taiwan - Hsin Chu
Tel: 886-3-572-9526
Fax: 886-3-572-6459

Taiwan - Kaohsiung
Tel: 886-7-536-4818
Fax: 886-7-536-4803

Taiwan - Taipei
Tel: 886-2-2500-6610
Fax: 886-2-2508-0102

Thailand - Bangkok
Tel: 66-2-694-1351
Fax: 66-2-694-1350

EUROPE

Austria - Wels
Tel: 43-7242-2244-39
Fax: 43-7242-2244-393

Denmark - Copenhagen
Tel: 45-4450-2828
Fax: 45-4485-2829

France - Paris
Tel: 33-1-69-53-63-20
Fax: 33-1-69-30-90-79

Germany - Munich
Tel: 49-89-627-144-0
Fax: 49-89-627-144-44

Italy - Milan
Tel: 39-0331-742611
Fax: 39-0331-466781

Netherlands - Drunen
Tel: 31-416-690399
Fax: 31-416-690340

Spain - Madrid
Tel: 34-91-708-08-90
Fax: 34-91-708-08-91

UK - Wokingham
Tel: 44-118-921-5869
Fax: 44-118-921-5820



Компания «ЭлектроПласт» предлагает заключение долгосрочных отношений при поставках импортных электронных компонентов на взаимовыгодных условиях!

Наши преимущества:

- Оперативные поставки широкого спектра электронных компонентов отечественного и импортного производства напрямую от производителей и с крупнейших мировых складов;
- Поставка более 17-ти миллионов наименований электронных компонентов;
- Поставка сложных, дефицитных, либо снятых с производства позиций;
- Оперативные сроки поставки под заказ (от 5 рабочих дней);
- Экспресс доставка в любую точку России;
- Техническая поддержка проекта, помощь в подборе аналогов, поставка прототипов;
- Система менеджмента качества сертифицирована по Международному стандарту ISO 9001;
- Лицензия ФСБ на осуществление работ с использованием сведений, составляющих государственную тайну;
- Поставка специализированных компонентов (Xilinx, Altera, Analog Devices, Intersil, Interpoint, Microsemi, Aeroflex, Peregrine, Syfer, Eurofarad, Texas Instrument, Miteq, Cobham, E2V, MA-COM, Hittite, Mini-Circuits, General Dynamics и др.);

Помимо этого, одним из направлений компании «ЭлектроПласт» является направление «Источники питания». Мы предлагаем Вам помощь Конструкторского отдела:

- Подбор оптимального решения, техническое обоснование при выборе компонента;
- Подбор аналогов;
- Консультации по применению компонента;
- Поставка образцов и прототипов;
- Техническая поддержка проекта;
- Защита от снятия компонента с производства.



Как с нами связаться

Телефон: 8 (812) 309 58 32 (многоканальный)

Факс: 8 (812) 320-02-42

Электронная почта: org@eplast1.ru

Адрес: 198099, г. Санкт-Петербург, ул. Калинина, дом 2, корпус 4, литера А.