



MAX17480 Evaluation Kit

Evaluates: MAX17480

General Description

The MAX17480 evaluation kit (EV kit) demonstrates the high-power, triple-output notebook CPU application circuit for the AMD® mobile serial VID interface (SVI) CPU core supplies. This DC-DC converter steps down high-voltage batteries and/or AC adapters, generating precision, low-voltage CPU cores. The MAX17480 EV kit meets the AMD mobile SVI CPU's transient voltage specification, power-good signaling, voltage-regulator thermal monitoring (VRHOT), and power-good output (PWRGD). The MAX17480 EV kit consists of one dual-phase high-current switched-mode power supply (SMPS) for the CPU core (VCORE0) and one 4A internal switch SMPS for the northbridge (NB) core. The two CPU core SMPSs run 180° out-of-phase for true interleaved operation, minimizing input capacitance.

Output voltages are dynamically changed through a 2-wire serial interface, allowing the switching regulators to be individually programmed to different voltages. A programmable slew-rate controller enables controlled transitions between VID codes. SVI also allows each regulator to be individually set into a low-power pulse-skipping state.

Soft-start limits the inrush current, and passive shut-down discharges the output voltage back down to zero without any negative ring. The MAX17480 EV kit includes active voltage positioning with adjustable gain, reducing power dissipation and bulk output capacitance requirements. The MAX17480 includes latched output undervoltage fault protection, overvoltage fault protection for the CPU cores, and thermal-overload protection. It also includes a voltage-regulator power-good (PWRGD) output.

This fully assembled and tested PCB provides a digitally adjustable 0 to 1.550V output-voltage range (7-bit on-board DAC) from a 7V to 24V battery input range. Each phase of the core current SMPS operates at 300kHz switching frequency and delivers up to 18A output current for a total of 36A. The 4A internal switch SMPS operates at 600kHz switching frequency and delivers up to 4A. The EV kit has superior line- and load-transient response. The EV kit also includes Windows® 2000-, Windows XP®, and Windows Vista®-compatible software that provides a simple graphical user interface (GUI) for exercising the features of the MAX17480.

AMD is a registered trademark of Advanced Micro Devices, Inc.

Windows, Windows XP, and Windows Vista are registered trademarks of Microsoft Corp.



For pricing, delivery, and ordering information, please contact Maxim Direct at 1-888-629-4642, or visit Maxim's website at www.maxim-ic.com.

Features

- ◆ **Dual/Triple-Output, Fixed-Frequency Controller**
- ◆ **AMD Mobile SVI-Compliant Serial Interface**
- ◆ **0 to 1.550V Output-Voltage Range (7-Bit On-Board DAC)**
- ◆ **Core SMPS**
 - ◆ **Split or Combinable Outputs Detected at Power-Up**
 - ◆ **True Out-of-Phase Operation Reduces Input Capacitance**
 - ◆ **Transient Phase Repeat Reduces Output Capacitance**
 - ◆ **Dynamic Phase Selection Optimizes Active/Sleep Efficiency**
 - ◆ **Programmable AC and DC Droop**
 - ◆ **7V to 24V Input-Voltage Range**
 - ◆ **36A Load-Current Capability (18A Each Phase)**
 - ◆ **Accurate Current Balance and Current Limit**
 - ◆ **300kHz Switching Frequency (Per Phase)**
 - ◆ **Output Overvoltage Fault Protection**
- ◆ **NB SMPS**
 - ◆ **4A Load-Current Capability for Northbridge Core**
 - ◆ **600kHz Switching Frequency for Northbridge**
- ◆ **Power-Good (PWRGD) and Thermal-Fault (VRHOT) Output Indicators**
- ◆ **System Power-OK (PGD_IN) Input**
- ◆ **Undervoltage Fault Protection**
- ◆ **40-Pin Thin QFN Package (5mm x 5mm)**
- ◆ **Lead(Pb)-Free and RoHS Compliant**
- ◆ **Fully Assembled and Tested**

Ordering Information

PART	TYPE
MAX17480EVKIT+	EV Kit

+Denotes lead(Pb)-free and RoHS compliant.

MAX17480 Evaluation Kit

Component List

DESIGNATION	QTY	DESCRIPTION
CORE0SENSE_H, CORE0SENSE_L, CORE1SENSE_H CORE1SENSE_L, NBSSENSE_H, PGD_IN, PWRGD, SHDN, VRHOT	9	Test points
C1–C4	4	10 μ F \pm 20%, 25V X5R ceramic capacitors (1210) TDK C3225X7R1E106M AVX 12103D106M Taiyo Yuden TMK325BJ106MM
C5, C7	0	Not installed, polymer capacitors (D case)
C6, C8, C19	3	330 μ F, 2V, 6m Ω low-ESR polymer capacitors (D case) NEC TOKIN PSGD0E337M6 Panasonic EEFSX0D331XE SANYO 2TPE330M6
C9, C12, C44–C48, C58, C78	9	0.1 μ F \pm 10%, 25V X7R ceramic capacitors (0603) TDK C1608X7R1E104K Murata GRM188R71E104K
C10, C11	2	2.2 μ F \pm 20%, 10V X5R ceramic capacitors (0603) TDK C1608X5R1A225M Murata GRM188R61A225M AVX 0603ZD225MAT
C13, C14, C24, C25, C76	5	0.22 μ F \pm 20%, 10V X7R ceramic capacitors (0603) Taiyo Yuden LMK107BJ224MA TDK C1608X7R1C224M AVX 06033D224KAT
C15, C17, C20, C23	4	4700pF \pm 10%, 50V X7R ceramic capacitors (0603) TDK C1608X7R1H472K Murata GRM188R71H472K
C16, C38, C39, C41, C42, C43, C53, C59–C62	0	Not installed, ceramic capacitors (0603)
C18, C51, C52	3	10 μ F \pm 20%, 6.3V X5R ceramic capacitors (0805) TDK C2012X5R0J106M Taiyo Yuden AMK212BJ106MG AVX 08056D106MAT

DESIGNATION	QTY	DESCRIPTION
C21, C22, C69, C70, C77	5	1000pF \pm 10%, 50V X7R ceramic capacitors (0603) TDK C1608X7R1H102K Murata GRM188R71H102K
C26–C37	12	22 μ F \pm 20%, 6.3V X5R ceramic capacitors (0805) TDK C2012X5R0J226MT Taiyo Yuden JMK212BJ226MG
C40	1	3300pF \pm 10%, 50V X7R ceramic capacitor (0603) TDK C1608X7R1H332K Taiyo Yuden UMK107B332MZ
C49, C50	2	1 μ F \pm 10%, 16V X7R ceramic capacitors (0603) TDK C1608X7R1C105K AVX 0603YD105MAT
C54, C55	2	22pF \pm 5%, 50V C0G ceramic capacitors (0603) TDK C1608C0G1H220J
C56, C57	2	10pF \pm 5%, 50V C0G ceramic capacitors (0603) TDK C1608C0G1H100J
C63, C64, C75	3	2200pF \pm 10%, 50V X7R ceramic capacitors (0603) TDK C1608X7R1H222K Murata GRM188R71H222K
C65	0	Not installed, polymer capacitor (D case) NEC TOKIN PSGD0E227M6 Panasonic EEFSX0D271XE SANYO 2TPE220M6
C66	1	100 μ F, 6.3V low-ESR capacitor (B case) SANYO 6TPE100MAZB NEC TOKIN PSLB0J107M(35)
C67, C68	2	330pF \pm 10%, 50V X7R ceramic capacitors (0603) TDK C1608X7R1H331K Taiyo Yuden UMK107B331KZ
C71–C74	4	22 μ F \pm 10%, 10V X7R ceramic capacitors (1210) Murata GRM32ER71A226K
D1, D2	2	3A, 30V Schottky diodes Nihon EC31QS03L Central Semi CMSH3-40M
D3, D4	2	LEDs, green clear SMD (0805)

MAX17480 Evaluation Kit

Component List (continued)

DESIGNATION	QTY	DESCRIPTION
J1	1	USB series-B right-angle PC-mount receptacle
J2	0	Not installed, dual-row (2 x 5) 10-pin header
J4, J5	2	Scope probe jacks
JU1, JU3–JU6	5	3-pin headers
JU2	1	5-pin header
JU7, JU8	2	2-pin headers
L1, L2	2	0.45 μ H, 30A, 1.1m Ω power inductors TOKO FDUE1040D-R45M or NEC TOKIN MPC1040LR45 or Panasonic ETQP4LR45XFC
L3	1	1.5 μ H, 5A, 21m Ω inductor TOKO FDV0530-1R5M NEC TOKIN MPLCH0525L1R5
N1, N2	2	n-channel MOSFETs (PowerPAK SO 8) Fairchild Semi FDS6298 (SO 8) Siliconix (Vishay) SI7634DP
N3–N6	4	n-channel MOSFETs (PowerPAK SO 8) Fairchild Semi FDS8670 (SO 8) Siliconix (Vishay) SI7336ADP
N7, N8	0	Not installed, n-channel MOSFETs (D-PAK)
R1, R2	2	10k Ω \pm 1% NTC thermistors, B = 3380 (0603) Murata NCP18XH103F03RB TDK NTCG163JH103F
R4	1	100k Ω \pm 1% resistor (0603)
R5	1	45.3k Ω \pm 1% resistor (0603)
R6	0	Not installed, resistor—short PC trace (0603)
R7	1	13k Ω \pm 1% resistor (0603)
R8	1	100k Ω \pm 5% NTC thermistor, B = 4250 (0603) Murata NCP18WF104J03RB TDK NTCG163JF104J (0402) or Panasonic ERT-J1VR104J
R9, R38, R39	3	100k Ω \pm 5% resistors (0603)
R10	1	143k Ω \pm 1% resistor (0603)

DESIGNATION	QTY	DESCRIPTION
R11, R51, R53–R56, R68	7	1k Ω \pm 5% resistors (0603)
R12, R17, R18, R19	4	3.01k Ω \pm 1% resistors (0603)
R13, R31, R34, R40, R41, R60, R61, R73	0	Not installed, resistors (0603)
R14, R20, R21	3	100 Ω \pm 5% resistors (0603)
R15, R22–R27, R57	8	0 Ω resistors (0603)
R16, R36	2	51 Ω \pm 5% resistors (0603)
R28, R35	0	Not installed, 1W resistors (2512)
R29, R32	2	2.43k Ω \pm 1% resistors (0603)
R30, R33	2	4.02k Ω \pm 1% resistors (0603)
R37, R69	2	10 Ω \pm 5% resistors (0603)
R42, R43, R45, R46	4	27 Ω \pm 5% resistors (0603)
R44, R47, R52, R58, R59	5	1.5k Ω \pm 5% resistors (0603)
R48	1	2.2k Ω \pm 5% resistor (0603)
R49	1	10k Ω \pm 5% resistor (0603)
R50	1	470 Ω \pm 5% resistor (0603)
R62–R66, R71, R72, R74	0	Not installed, resistors—short (PC trace) (0603)
R67	1	2 Ω \pm 5% resistor (0603)
R70	1	5.1k Ω \pm 5% resistor (0603)
SW1–SW4	4	Pushbutton switches
TP1, TP2	0	Not installed, test points
U1	1	AMD SVI mobile regulator (40 TQFN) Maxim MAX17480GTL+
U2	1	Low-power LCD microcontroller (68 QFN-EP*) Maxim MAXQ2000-RAX+
U3	1	93C46 type 3-wire EEPROM (8 SO) 16-bit architecture Atmel AT93C46EN-SH-B
U4	1	UART-to-USB converter (32 TQFP) FTDI FT232BL

*EP = Exposed pad.

Evaluates: MAX17480

MAX17480 Evaluation Kit

Component List (continued)

DESIGNATION	QTY	DESCRIPTION
U5	1	3.3V, 120mA linear regulator (5 SC70) Maxim MAX8511EXK33+T (Top Mark: AEI)
U6	1	2.5V, 120mA linear regulator (5 SC70) Maxim MAX8511EXK25+T (Top Mark: ADV)

DESIGNATION	QTY	DESCRIPTION
Y1	1	16MHz crystal
Y2	1	6MHz crystal
—	8	Shunts
—	1	PCB: MAX17480 EVALUATION KIT+

Component Suppliers

SUPPLIER	PHONE	WEBSITE
AVX Corp.	843-946-0238	www.avxcorp.com
Central Semiconductor Corp.	631-435-1110	www.centalsemi.com
Fairchild Semiconductor	888-522-5372	www.fairchildsemi.com
Murata Electronics North America, Inc.	770-436-1300	www.murata-northamerica.com
NEC TOKIN America, Inc.	408-324-1790	www.nec-tokinamerica.com
Nihon Inter Electronics Corp.	847-843-7500	www.niec.co.jp
Panasonic Corp.	800-344-2112	www.panasonic.com
SANYO Electric Co., Ltd.	619-661-6835	www.sanyodevice.com
Taiyo Yuden	800-348-2496	www.t-yuden.com
TDK Corp.	847-803-6100	www.component.tdk.com
TOKO America, Inc.	847-297-0070	www.tokoam.com
Vishay	402-563-6866	www.vishay.com

Note: Indicate that you are using the MAX17480 when contacting these component suppliers.

MAX17480 EV Kit Files

FILE	DESCRIPTION
INSTALL.EXE	Installs the EV kit files on your computer
MAX17480.EXE	Application program
FTD2XX.INF	USB device driver file
UNINST.INI	Uninstalls the EV kit software
USB_Driver_Help.PDF	USB driver installation help file

MAX17480 Evaluation Kit

Evaluates: MAX17480

Quick Start

Recommended Equipment

- MAX17480 EV kit (USB cable included)
- 7V to 24V, > 100W power supply, battery, or notebook AC adapter
- DC bias power supply, 5V at 3A
- One load capable of sinking 40A
- One load capable of sinking 4A
- Digital multimeters (DMMs)
- 100MHz dual-trace oscilloscope
- User-supplied Windows 2000, Windows XP, or Windows Vista PC with a spare USB port

Note: In the following sections, software-related items are identified by bolding. Text in bold refers to items directly from the EV kit software. Text in **bold and underlined** refers to items from the Windows operating system.

Procedure

The MAX17480 EV kit is fully assembled and tested. Follow the steps below to verify board operation.

Caution: Do not turn on the power supply until all connections are completed.

- 1) Visit www.maxim-ic.com/evkitsoftware to download the latest version of the EV kit software, 17480xx.ZIP. Save the EV kit software to a temporary folder and uncompress the ZIP file.
- 2) Install the EV kit software on your computer by running the INSTALL.EXE program inside the temporary folder.
The program files are copied and icons are created in the Windows **Start | Programs** menu.
- 3) Ensure that the circuit is connected correctly to the supplies and dummy loads prior to applying any power.

- 4) Verify that there are shunts installed across jumpers JU2, pins 1-2 (OPTION = VDD) and JU3, pins 1-2 (ILIM3 = VDD).
- 5) Verify that there is a shunt installed across jumpers JU1, pins 1-2 (PGD_IN), JU4, pins 1-2 ($\overline{\text{SHDN}}$), JU5, pins 1-2 (SVD), JU6, pins 1-2 (SVC), allowing U2 to control the MAX17480, and JU8, pins 1-2, IN3 connected to VBIAS.
- 6) Turn on the battery power before turning on the 5V power supply.
- 7) Connect the USB cable from the PC to the EV kit board. A **Building Driver Database** window pops up in addition to a **New Hardware Found** message when installing the USB driver for the first time. If you do not see a window that is similar to the one described above after 30 seconds, remove the USB cable from the board and reconnect it. Administrator privileges are required to install the USB device driver on Windows 2000, Windows XP, and Windows Vista. Refer to the USB_Driver_Help.PDF document included with the software if you have any problems during this step.
- 8) Follow the directions of the **Add New Hardware Wizard** to install the USB device driver. Choose the **Search for the best driver for your device** option. Specify the location of the device driver to be **C:\Program Files\MAX17480** (default installation directory) using the **Browse** button.
- 9) Start the EV kit software by opening its icon in the **Start | Programs** menu. The EV kit software main window should appear, as shown in Figure 1.
- 10) Check the **Core 0, Combined Mode**, and **North Bridge** checkboxes. Move any slider to adjust the voltage to 1.2000V and press the **Send Data** button.
- 11) Observe the 1.2000V output voltage on the SMPS outputs (VCORE0 and VOUT_NB) with the DMM and/or oscilloscope. Look at the LX switching nodes and MOSFET gate-drive signals while varying the load current.

MAX17480 Evaluation Kit

__Detailed Description of Software

The main window of the evaluation software (Figure 1) displays **Address to Send**, **Data to Send**, **Last Address Sent**, and **Last Data Sent** status. In addition, the GUI allows the user to select **Combined Mode**, **Core 0**, **Core 1**, and/or **North Bridge** outputs.

The sliders to the right of each output checkbox correspond with the output-voltage setting for that core. The **Send Data** button must be pressed to write the new output-voltage setting(s) to the MAX17480. The **Last Address Sent** and **Last Data Sent** status helps the user keep track of the last transmission.

Operating Mode (Combined/Separate)

At start-up, the software is configured for combined-mode operation (**Combined Mode** checkbox checked). In combined mode, the MAX17480 ignores Core 1 commands. To configure the software for separate-mode operation, uncheck the **Combined Mode** checkbox and follow the instructions in the *Separate-Mode Operation* section.

Saving Power

Unchecking the **Power-Saving Off** checkbox puts the MAX17480 in power-saving mode (skip mode). The MAX17480 is in normal operation (PWM mode) while the **Power-Saving Off** checkbox is checked.

Resetting the GUI (RESET GUI)

The software main window needs to be synchronized to the MAX17480 EV kit hardware after the following events:

- Pressing any of the on-board switches (SW1–SW4)
- Re-cycling 5V power to the MAX17480 EV kit

Press the **RESET GUI** button after any of the above events to use the software main window again.

I²C Low-Level Commands

Press the **Options | 2-wire low level** menu item at the top of the GUI to execute low-level I²C interface commands. Once the new window opens, go to the **2-wire Interface** tab | **General Commands** | **SMBusWriteByte (addr,cmd,data8)** to write hex data manually into the registers of the MAX17480.

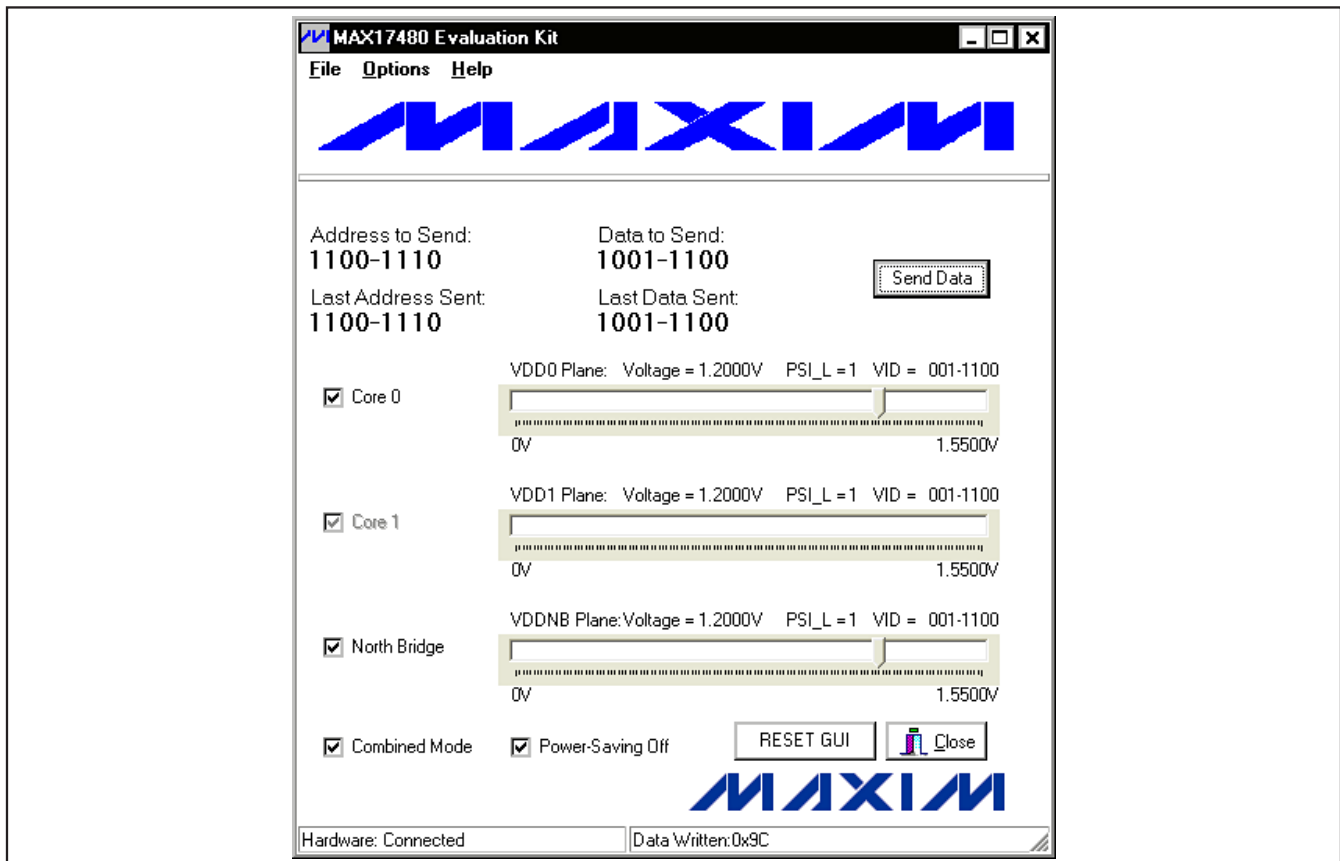

Figure 1. MAX17480 EV Kit Software Main Window

MAX17480 Evaluation Kit

Detailed Description of Firmware

The on-board switches (SW1–SW4) allow the user to perform four different predetermined high-speed I²C tests. Detailed descriptions of each dynamic output test follow.

The sequence for the dynamic output test assigned to SW1 is shown in Table 1.

The sequence for the dynamic output test assigned to SW2 is shown in Table 2.

The sequence for the dynamic output test assigned to SW3 is shown in Table 3.

The sequence for the dynamic output test assigned to SW4 is shown in Table 4.

Note: When in combined mode, the MAX17480 ignores DAC2 settings. The device only responds to settings made to DAC1 (Core 0) and DAC3 (NB).

Table 1. SW1 Dynamic Output Test with High-Speed I²C Interface

STEP	ADDRESS	DATA	DESCRIPTION
1	0xC4	0xCC	Set DAC1 to 0.6V (Core 0)
2	N/A	N/A	Wait 100μs
3	0xC8	0xCC	Set DAC2 to 0.6V (Core 1)
4	N/A	N/A	Wait 100μs
5	0xC2	0xCC	Set DAC3 to 0.6V (NB)
6	N/A	N/A	Wait 100μs
7	0xC4	0x94	Set DAC1 to 1.3V (Core 0)
8	N/A	N/A	Wait 100μs
9	0xC8	0x94	Set DAC2 to 1.3V (Core 1)
10	N/A	N/A	Wait 100μs
11	0xC2	0x94	Set DAC3 to 1.3V (NB)

N/A = Not applicable.

Table 2. SW2 Dynamic Output Test with High-Speed I²C Interface

STEP	ADDRESS	DATA	DESCRIPTION
1	0xC4	0xFF	Set DAC1 to 0V (Core 0)
2	N/A	N/A	Wait 100μs
3	0xC8	0xFF	Set DAC2 to 0V (Core 1)
4	N/A	N/A	Wait 100μs
5	0xC2	0xFF	Set DAC3 to 0V (NB)
6	N/A	N/A	Wait 100μs
7	0xC4	0x80	Set DAC1 to 1.55V (Core 0)
8	N/A	N/A	Wait 100μs
9	0xC8	0x80	Set DAC2 to 1.55V (Core 1)
10	N/A	N/A	Wait 100μs
11	0xC2	0x80	Set DAC3 to 1.55V (NB)

N/A = Not applicable.

MAX17480 Evaluation Kit

Table 3. SW3 Dynamic Output Test with High-Speed I²C Interface

STEP	ADDRESS	DATA	DESCRIPTION
1	0xC4	0xCC	Set all DACs to 0V (Core 0, Core 1, and NB)
2	N/A	N/A	Wait 1ms
3	0xC8	0xCC	Set all DACs to 1.55V (Core 0, Core 1, and NB)

N/A = Not applicable.

Table 4. SW4 Dynamic Output Test with High-Speed I²C Interface

STEP	ADDRESS	DATA	DESCRIPTION
1	N/A	N/A	Set $\overline{\text{SHDN}}$ and PGD_IN to logic-low
2	N/A	N/A	Wait 10ms
3	N/A	N/A	Set SVC to logic-low and SVD to logic-high
4	N/A	N/A	Set $\overline{\text{SHDN}}$ to logic-high
5	N/A	N/A	Wait 2ms
6	N/A	N/A	Set PGD_IN to logic-high
7	N/A	N/A	Wait 10 μ s
8	0xCE	0x9C	Set all DACs to 1.2V (Core 0, Core 1, and NB)

N/A = Not applicable.

Detailed Description of Hardware

The MAX17480 EV kit consists of one dual-phase SMPS for the CPU core, and one 4A internal switch SMPS for the northbridge core. The SMPS buck-regulator design is optimized for a 300kHz switching frequency per phase and output-voltage settings around 1.200V. At $V_{\text{OUT}} = 1.200\text{V}$ and $V_{\text{IN}} = 12\text{V}$, the inductor ripple is approximately 30% (LIR = 0.3). The MAX17480 controller interleaves both phases, resulting in 180° out-of-phase operation that minimizes the input and output filtering requirements. The MAX17480 controller shares the current between the two phases, supplying up to **18A per phase**. The 4A internal-switch SMPS operates at 600kHz switching frequency and delivers up to 4A.

The MAX17480 EV kit is configured to evaluate the MAX17480 IC in combined-mode operation. In combined mode, core SMPSs (SMPS1 and SMPS2) are combined into a single output (VCORE0). The EV kit can be configured to operate in separate mode to provide two outputs, VCORE0 (SMPS1) and VCORE1 (SMPS2). See the *Separate-Mode Operation* section for configuration details.

Setting the Output Voltage

7-Bit DAC

Inside the MAX17480 are three 7-bit digital-to-analog converters (DACs). Each DAC can be individually programmed to different voltage levels through the serial-

interface bus. The DAC sets the target for the output voltage for the SMPSs. The available DAC codes, and resulting output voltages, are compatible with the AMD SVI specifications (see Table 5).

2-Wire Serial Interface (SVC, SVD)

The MAX17480 supports the 2-wire write-only serial-interface bus, as defined by the AMD serial VID interface specification. The serial interface is similar to the high-speed 3.4MHz I²C bus, but without the master-mode sequence. The bus consists of a clock line (SVC) and a data line (SVD). The CPU is the bus master and the MAX17480 is the slave.

The MAX17480 serial interface works from 100kHz to 3.4MHz. In the AMD mobile application, the bus runs at 3.4MHz. In the MAX17480 EV kit, the serial interface operates at 400kHz when commands are sent through the EV kit software. When using the preprogrammed SW switches, the serial interface operates at 1.7MHz.

The serial interface is active only after PGD_IN goes high in the startup sequence. The CPU sets the VID voltage of the three internal DACs and the PSI_L bit through the serial interface after PGD_IN goes high.

During the startup sequence, the SVC and SVD inputs serve an alternate function to set the 2-bit boot VID for all three DACs while PWRGD is low, and are in the serial-interface mode when PGD_IN is high.

MAX17480 Evaluation Kit

By default, the MAX17480 serial interface is controlled by U2 through the jumper settings on JU5 (pins 1-2) and JU6 (pins 1-2). To directly control the MAX17480

with an external I²C serial interface, connect the external controller to the SDA and SCL pads and move the shunts on JU5 and JU6 across pins 2-3.

Evaluates: MAX17480

Table 5. Output-Voltage VID DAC Codes

SVID[6:0]	OUTPUT VOLTAGE (V)	SVID[6:0]	OUTPUT VOLTAGE (V)	SVID[6:0]	OUTPUT VOLTAGE (V)	SVID[6:0]	OUTPUT VOLTAGE (V)
000_0000	1.5500	010_0000	1.1500	100_0000	0.7500	110_0000	0.3500
000_0001	1.5375	010_0001	1.1375	100_0001	0.7375	110_0001	0.3375
000_0010	1.5250	010_0010	1.1250	100_0010	0.7250	110_0010	0.3250
000_0011	1.5125	010_0011	1.1125	100_0011	0.7125	110_0011	0.3125
000_0100	1.5000	010_0100	1.1000	100_0100	0.7000	110_0100	0.3000
000_0101	1.4875	010_0101	1.0875	100_0101	0.6875	110_0101	0.2875
000_0110	1.4750	010_0110	1.0750	100_0110	0.6750	110_0110	0.2750
000_0111	1.4625	010_0111	1.0625	100_0111	0.6625	110_0111	0.2625
000_1000	1.4500	010_1000	1.0500	100_1000	0.6500	110_1000	0.2500
000_1001	1.4375	010_1001	1.0375	100_1001	0.6375	110_1001	0.2375
000_1010	1.4250	010_1010	1.0250	100_1010	0.6250	110_1010	0.2250
000_1011	1.4125	010_1011	1.0125	100_1011	0.6125	110_1011	0.2125
000_1100	1.4000	010_1100	1.0000	100_1100	0.6000	110_1100	0.2000
000_1101	1.3875	010_1101	0.9875	100_1101	0.5875	110_1101	0.1875
000_1110	1.3750	010_1110	0.9750	100_1110	0.5750	110_1110	0.1750
000_1111	1.3625	010_1111	0.9625	100_1111	0.5625	110_1111	0.1625
001_0000	1.3500	011_0000	0.9500	101_0000	0.5500	111_0000	0.1500
001_0001	1.3375	011_0001	0.9375	101_0001	0.5375	111_0001	0.1375
001_0010	1.3250	011_0010	0.9250	101_0010	0.5250	111_0010	0.1250
001_0011	1.3125	011_0011	0.9125	101_0011	0.5125	111_0011	0.1125
001_0100	1.3000	011_0100	0.9000	101_0100	0.5000	111_0100	0.1000
001_0101	1.2875	011_0101	0.8875	101_0101	0.4875	111_0101	0.0875
001_0110	1.2750	011_0110	0.8750	101_0110	0.4750	111_0110	0.0750
001_0111	1.2625	011_0111	0.8625	101_0111	0.4625	111_0111	0.0625
001_1000	1.2500	011_1000	0.8500	101_1000	0.4500	111_1000	0.0500
001_1001	1.2375	011_1001	0.8375	101_1001	0.4375	111_1001	0.0375
001_1010	1.2250	011_1010	0.8250	101_1010	0.4250	111_1010	0.0250
001_1011	1.2125	011_1011	0.8125	101_1011	0.4125	111_1011	0.0125
001_1100	1.2000	011_1100	0.8000	101_1100	0.4000	111_1100	OFF
001_1101	1.1875	011_1101	0.7875	101_1101	0.3875	111_1101	OFF
001_1110	1.1750	011_1110	0.7750	101_1110	0.3750	111_1110	OFF
001_1111	1.1625	011_1111	0.7625	101_1111	0.3625	111_1111	OFF

Note: The NB SMPS output voltage has an offset of +12.5mV.

MAX17480 Evaluation Kit

Table 6. Boot-Voltage Codes

SVC	SVD	BOOT VOLTAGE V _{BOOT} (V)
0	0	1.1
0	1	1.0
1	0	0.9
1	1	0.8

Boot Voltage

On startup, the MAX17480 slews the target for all three DACs from ground to the boot voltage set by the SVC and SVD pin voltage levels. While the output is still below regulation, the SVC and SVD levels can be changed and the MAX17480 will set the DACs to the new boot voltage. Once the programmed boot voltage is reached and PWRGD goes high, the MAX17480 stores the boot VID. Changes in the SVC and SVD settings do not change the output voltage once the boot VID is stored. When PGD_IN goes high, the MAX17480 exits boot mode, and the three DACs can be independently set to any voltage in the VID table through the serial interface.

If PGD_IN goes from high to low any time after the boot VID is stored, the MAX17480 sets all three DACs back to the voltage of the stored boot VID. Table 6 shows the boot-voltage codes.

Reduced Power-Dissipation Voltage Positioning

Each phase of the MAX17480 core-supply SMPS includes one transconductance amplifier for AC droop. The amplifiers' inputs are generated by summing the respective current-sense inputs, which differentially sense the voltage across the inductor's DCR. The transconductance amplifier's output (FBAC) connects to the feedback input (FBDC) through a capacitor (C63 for phase 1 and C64 for phase 2), resulting in AC-coupling of the ripple voltage with no DC voltage, giving no DC droop in the default configuration.

For applications that require voltage positioning, install the resistor between FBAC and FBDC (R60 for phase 1 and R61 for phase 2). The resulting DC droop is a fraction of the AC-droop setting. Refer to the MAX17480 IC data sheet for detailed information on setting AC and DC droop.

Load-Transient Experiment

One interesting experiment is to subject the output to large, fast load transients and observe the output with an oscilloscope. Accurate measurement of output ripple and load-transient response invariably requires that ground clip leads be completely avoided and that the probe be removed to expose the GND shield, so the probe can be directly grounded with as short a wire as possible to the board. Otherwise, EMI and noise pickup corrupt the waveforms.

Most benchtop electronic loads intended for power-supply testing lack the ability to subject the DC-DC converter to ultra-fast load transients. Emulating the supply current (di/dt) at the CPU V_{CORE} pins requires at least 500A/ μ s load transients. An easy method for generating such an abusive load transient is to install a power MOSFET at the N7 location and install resistor R35 between 5m Ω and 10m Ω to monitor the transient current. Then drive its gate (TP1) with a strong pulse generator at a low duty cycle (< 5%) to minimize heat stress in the MOSFET. Vary the high-level output voltage of the pulse generator to vary the load current.

To determine the load current, you might expect to insert a meter in the load path, but this method is prohibited here by the need for low resistance and inductance in the path of the dummy-load MOSFET. To determine how much load current a particular pulse-generator amplitude is causing, observe the current through inductor L1. In the buck topology, the load current is approximately equal to the average value of the inductor current.

Jumper Settings

Shutdown ($\overline{\text{SHDN}}$)

When $\overline{\text{SHDN}}$ goes low (JU4 = GND), the MAX17480 immediately enters the shutdown mode and PWRGD is pulled low immediately—the drivers are disabled, the reference turns off, the supply currents drop to approximately 1 μ A (max), and all three outputs are discharged through 20 Ω internal discharge FETs through the CSN pin for the core SMPSs and through the OUT3 pin for the NB SMPS.

When an overvoltage or undervoltage fault condition occurs on the core SMPS, the NB SMPS immediately shuts down. To clear the fault latch and reactivate the controller, toggle $\overline{\text{SHDN}}$ or cycle V_{CC} power (see Table 7).

MAX17480 Evaluation Kit

Evaluates: MAX17480

Table 7. Jumper JU4 Function (SHDN)

SHUNT POSITION	SHDN PIN	MAX17480 OUTPUT
1-2	Connected to U2, pin 58	—
2-3	Connected to GND	Shutdown mode, SMPS output voltages disabled. VCORE0 = 0V and VOUT_NB = 0V.
Not installed	Connected to VDD through 100kΩ resistor R9	SMPS output voltages enabled. VCORE0 and VOUT_NB voltages are set by SVC and SVD inputs.

System Power-Good Input (PGD_IN)

After the SMPS outputs reach the boot voltage, the MAX17480 switches over to the serial-interface mode when PGD_IN goes high. Any time during normal operation, a high-to-low transition on PGD_IN causes the MAX17480 to slew all three internal DACs back to the stored boot VIDs. The SVC and SVD inputs are disabled during the time that PGD_IN is low. The serial interface is re-enabled when PGD_IN goes high again (see Table 8).

Offset and Address Change for Core SMPSs (OPTION)

The +12.5mV offset and the address change features of the MAX17480 can be selectively enabled and disabled by the OPTION pin setting. When the offset is enabled, setting the PSI_L bit to 0 disables the offset, reducing power consumption in the low-power state. Refer to the *Core SMPS Offset* section in the MAX17480 IC data sheet for a detailed description of this feature.

When configured in separate mode, the address of the core SMPSs (VCORE0 and VCORE1) can be exchanged, allowing for flexible layout of the MAX17480 with respect to the CPU placement on the same or opposite sides of the PCB. Table 9 shows the OPTION pin voltage levels and the features that are enabled.

Table 8. Jumper JU1 Function (PGD_IN)

SHUNT POSITION	PGD_IN PIN	MAX17480 OUTPUT
1-2	Connected to U2, pin 59	—
2-3	Connected to GND	The SVC and SVD inputs are disabled during the time PGD_IN is low.
Not installed	Connected to 2.5V through 100kΩ resistor R39	The serial interface is re-enabled when PGD_IN goes high again. The MAX17480 switches over to the serial-interface mode when PGD_IN goes high.

Table 9. Jumper JU2 Function (OPTION)

SHUNT POSITION	OPTION PIN	OFFSET ENABLED	SMPS1 ADDRESS**	SMPS2 ADDRESS**
1-2*	Connected to VDD	0	BIT 1 (VDD0)	BIT 2 (VDD1)
1-5	Connected to 3.3V	0	BIT 2 (VDD1)	BIT 1 (VDD0)
1-3	Connected to OSC	1	BIT 1 (VDD0)	BIT 2 (VDD1)
1-4	Connected to GND	1	BIT 2 (VDD1)	BIT 1 (VDD0)

*Default position.

**VDD0 refers to CORE0 and VDD1 refers to CORE1 for the AMD CPU.

Note: In combined mode, the Address is NOT changed by the OPTION pin setting. The offset can still be set by any of the four levels (shunt positions).

MAX17480 Evaluation Kit

Offset and Current-Limit Setting for NB SMPSs (ILIM3)

The offset and current-limit settings of the NB SMPS can be set by the ILIM3 pin setting. Table 10 shows the ILIM3 pin voltage levels and the corresponding settings for the offset and current limit of the NB SMPS. Refer to the *NB SMPS Offset* and the *Peak Current Limit* sections in the MAX17480 IC data sheet for a detailed description of the respective features. The 12.5mV NB SMPS offset is always present regardless of PSI_L setting.

Combined-Mode Operation

The MAX17480 EV kit is configured for combined-mode operation with GNDS2 connected to VDDIO through R74 (PC trace short). To work with the address change feature, the MAX17480 could alternatively be configured in combined mode by connecting GNDS1 to VDDIO and using GNDS2 as the remote ground-sense connection. To do this, remove R21 and use a wire to connect GNDS1 to VDDIO. Then cut the PC trace short at R74 and install resistor R13 (100Ω, 0603) and capacitor C16 (4700pF, 0603).

The SW1–SW4 switches and the EV kit software controls the combined SMPS and VOUT_NB outputs in combined mode. In combined mode, the MAX17480 SMPS only responds to Core 0 commands. Core 1 commands are ignored.

In combined mode, unchecking the **Power-Saving Off** checkbox in the software sets the MAX17480 SMPS into single-phase operation. Checking the **Power-Saving Off** checkbox in the software sets the MAX17480 SMPS into dual-phase operation.

Separate-Mode Operation

Separate-mode operation can be evaluated by installing the MAX17480 onto the MAX17080 EV kit. Alternatively, separate-mode evaluation on the MAX17480 EV kit can be done by separating C5 and C6 from C7 and C8 and connecting GNDS2 to the low-end remote sense of Core 1 (CORESENSE1_L). This is accomplished by making the following changes to the EV kit:

- 1) Uninstall capacitor C19.
- 2) Cut the VCORE0 planes (top and bottom sides) in half. Cut along the exposed copper that runs through the planes.
- 3) Cut the short at R74.
- 4) Install resistor R13 (100Ω, 0603) and capacitor C16 (4700pF, 0603).

The SW1–SW4 pushbutton switches and the EV kit software still control the core SMPSs (VCORE0 and VCORE1) and VOUT_NB outputs in separate mode. In separate mode, the MAX17480 SMPS1 responds to Core 0 commands and SMPS2 responds to CORE 1 commands.

In separate mode, unchecking the **Power-Saving Off** checkbox in the software sets each MAX17480 SMPS into one-phase skip mode (power-saving mode). Checking the **Power-Saving Off** checkbox in the software sets each MAX17480 SMPS in PWM mode.

Table 10. Jumper JU3 Function (ILIM3)

SHUNT POSITION	ILIM3	PEAK CURRENT LIMIT (A)	MAX DC CURRENT (A)	FULL-LOAD DROOP (mV)
1-2*	Connected to VDD	5.25	4.75	-26.13
2-3	Connected to GND	4.25	3.75	-20.63

*Default position.

MAX17480 Evaluation Kit

Evaluates: MAX17480

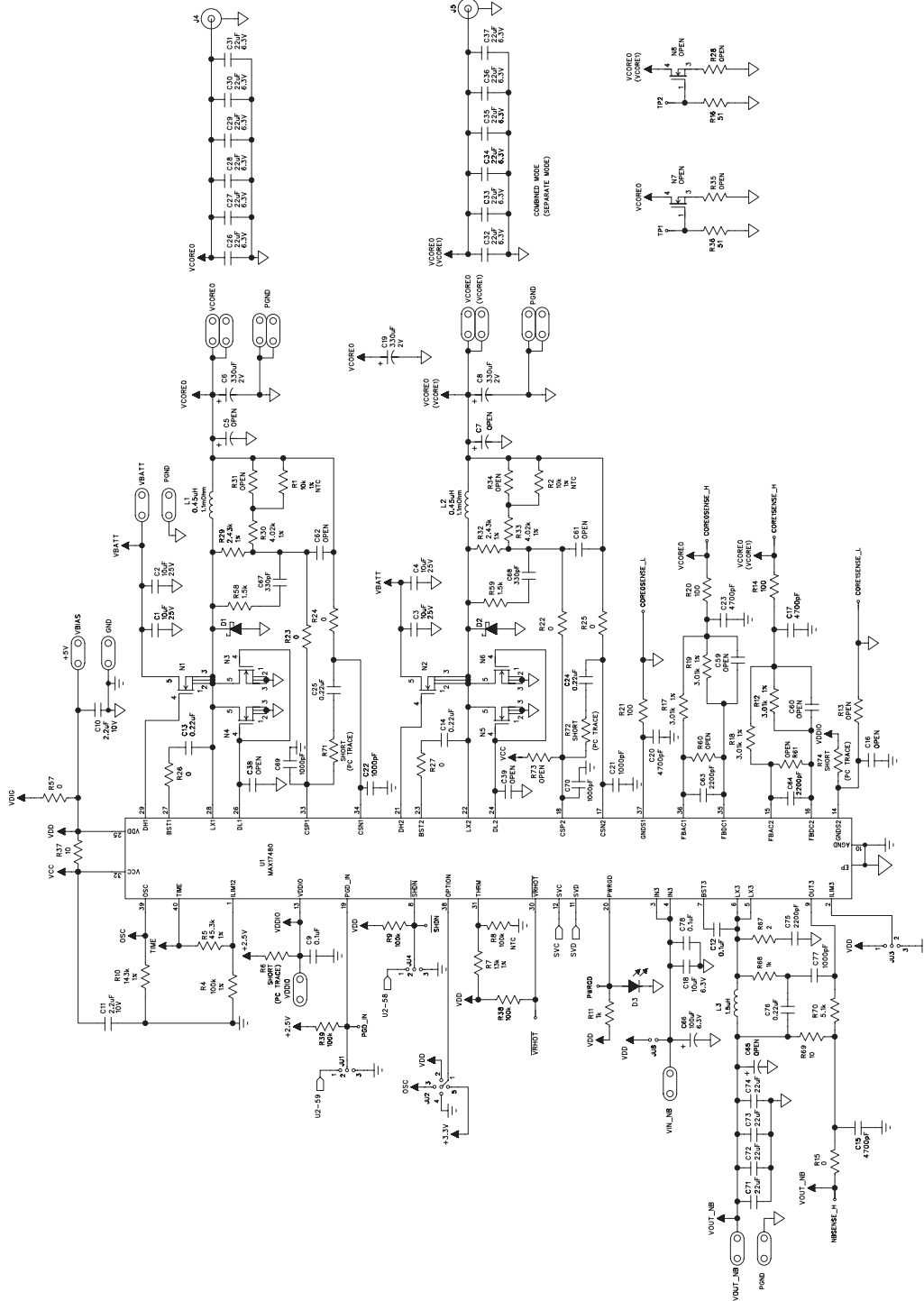

Figure 2a. MAX17480 EV Kit Schematic (Sheet 1 of 2)

MAX17480 Evaluation Kit

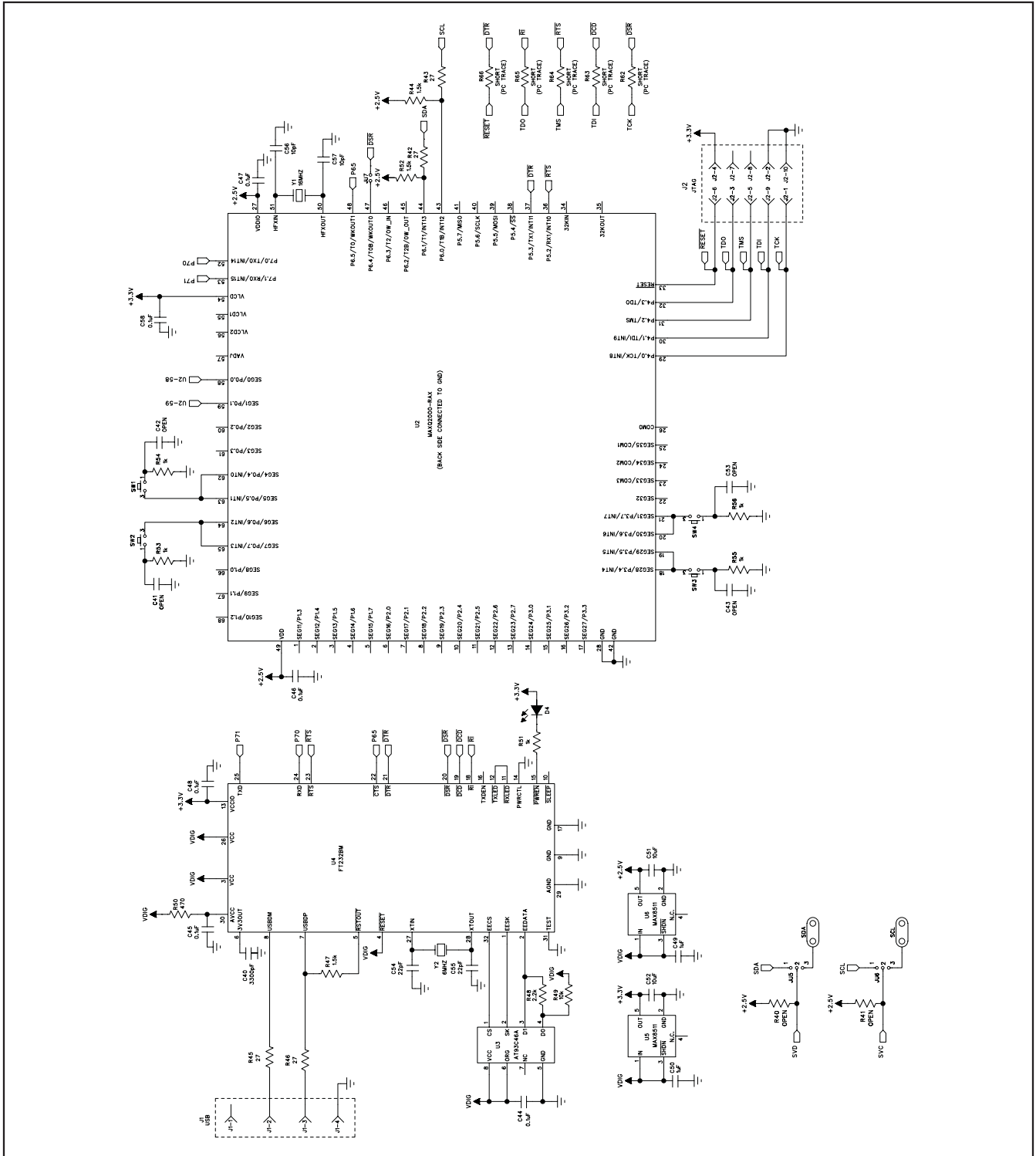

Figure 2b. MAX17480 EV Kit Schematic (Sheet 2 of 2)

MAX17480 Evaluation Kit

Evaluates: MAX17480

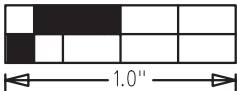
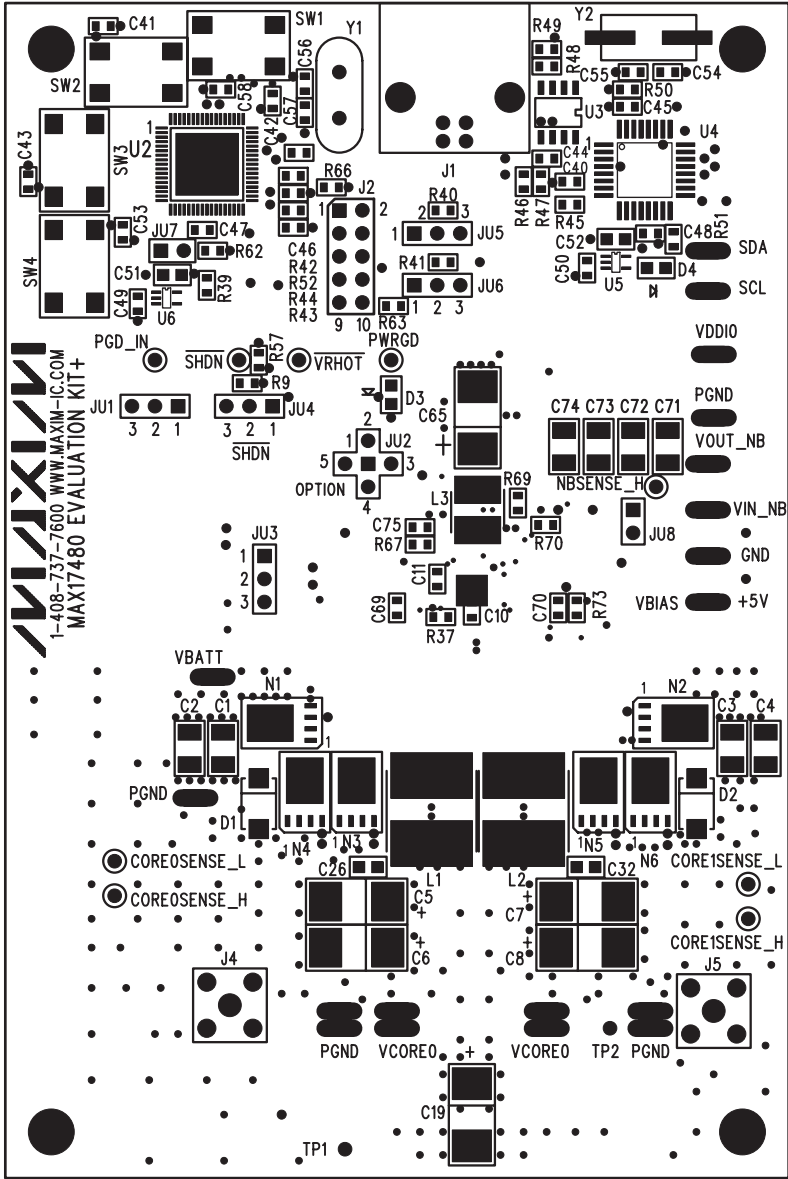

Figure 3. MAX17480 EV Kit Component Placement Guide—Component Side

MAX17480 Evaluation Kit

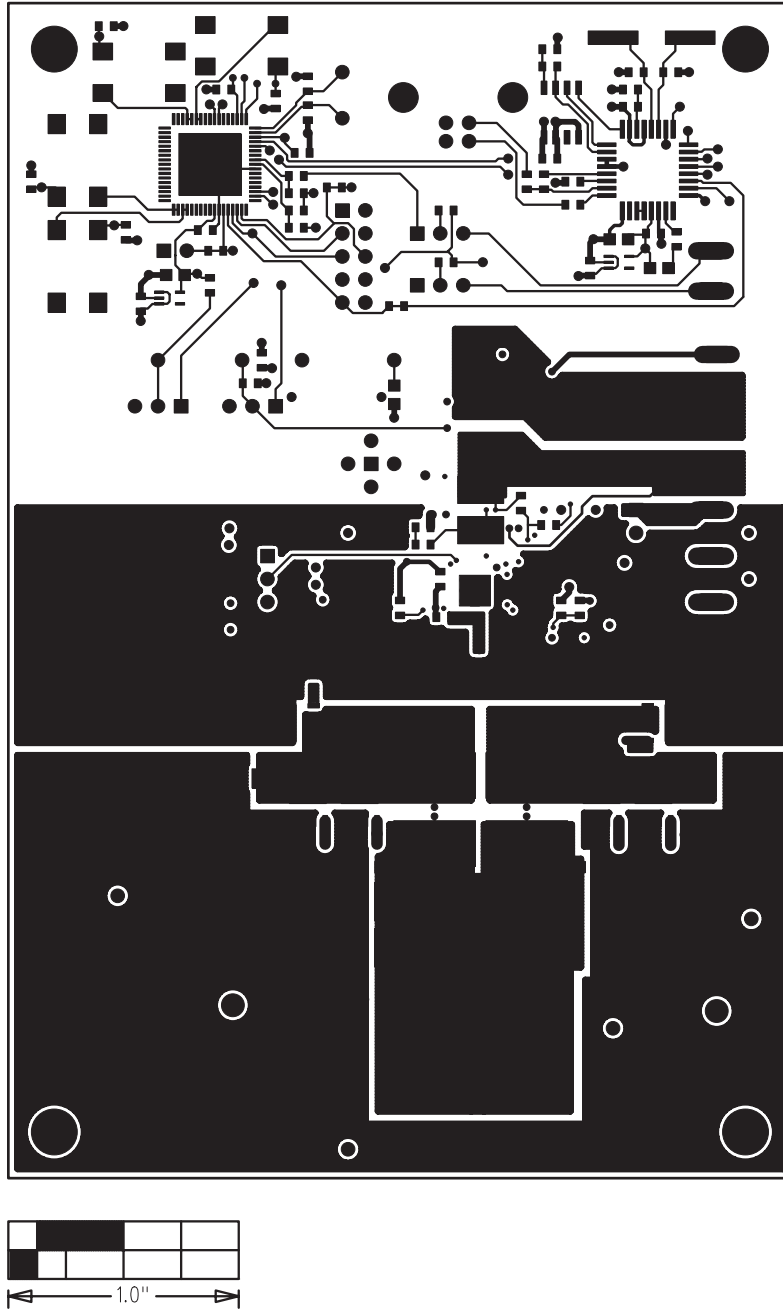

Figure 4. MAX17480 EV Kit PCB Layout—Component Side

MAX17480 Evaluation Kit

Evaluates: MAX17480

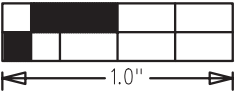
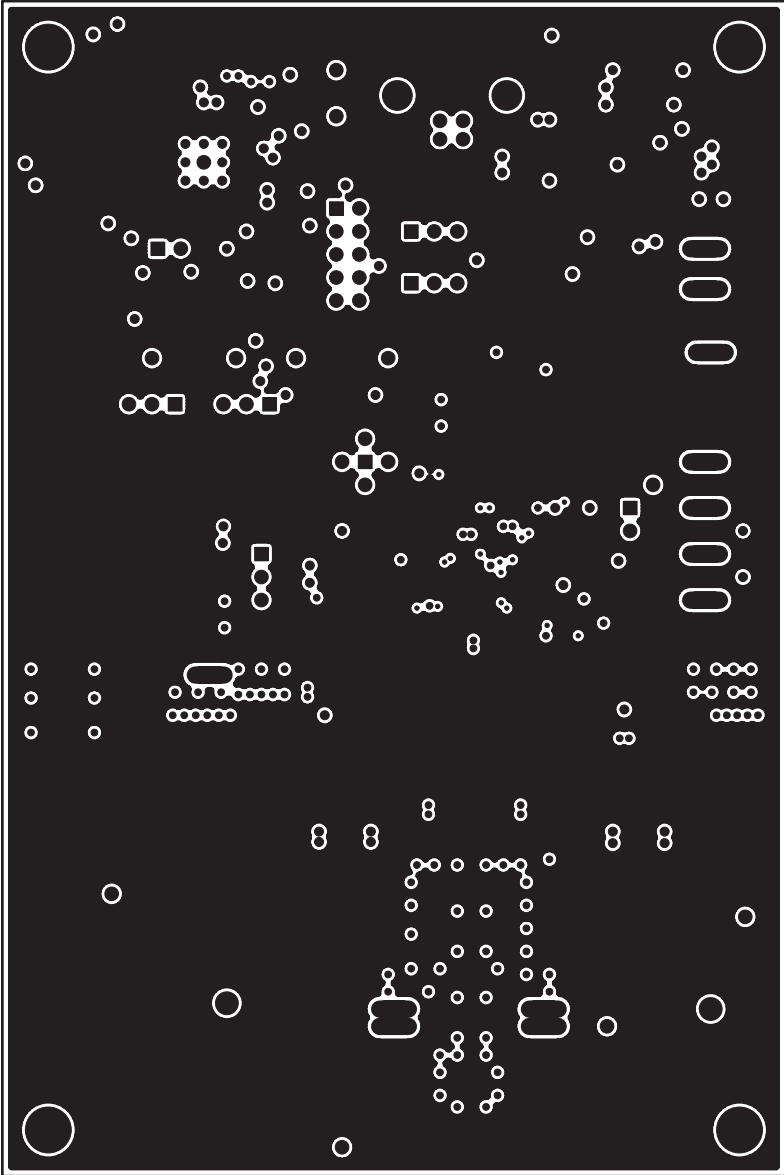

Figure 5. MAX17480 EV Kit PCB Layout—Internal Layer 2

MAX17480 Evaluation Kit

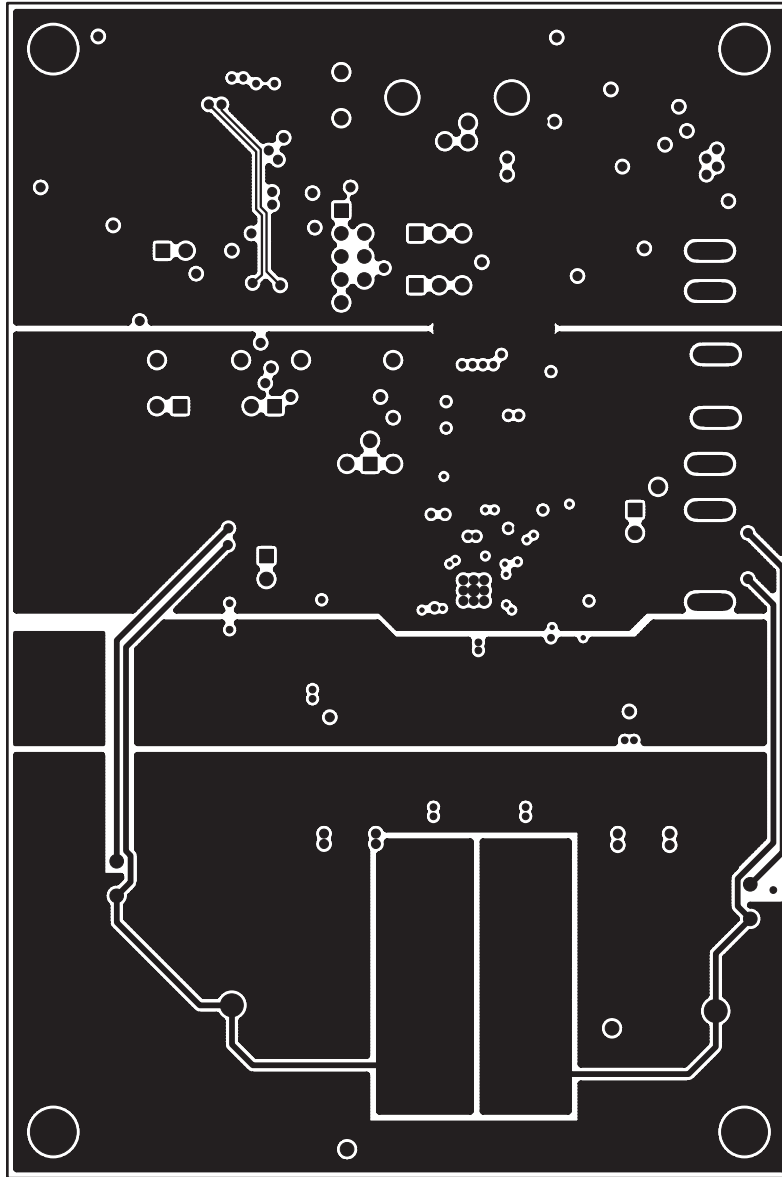

Figure 6. MAX17480 EV Kit PCB Layout—Internal Layer 3

MAX17480 Evaluation Kit

Evaluates: MAX17480

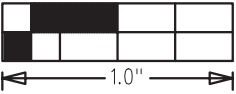
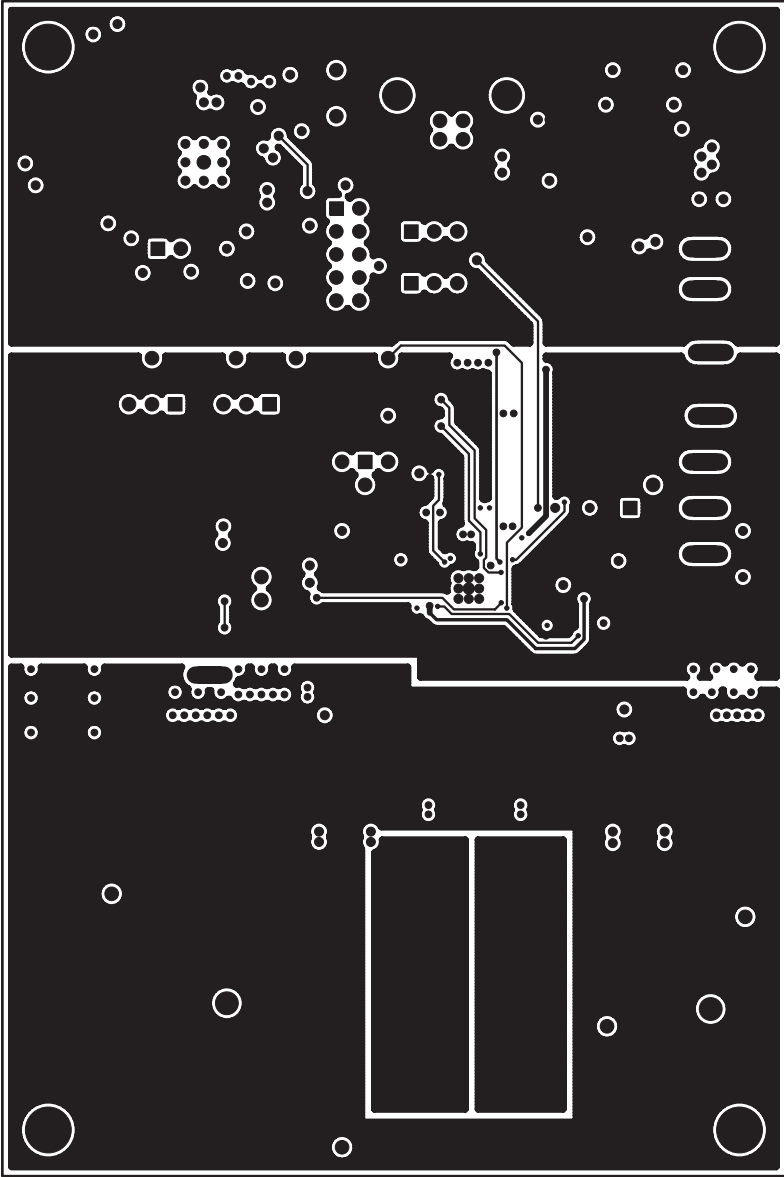

Figure 7. MAX17480 EV Kit PCB Layout—Internal Layer 4

MAX17480 Evaluation Kit

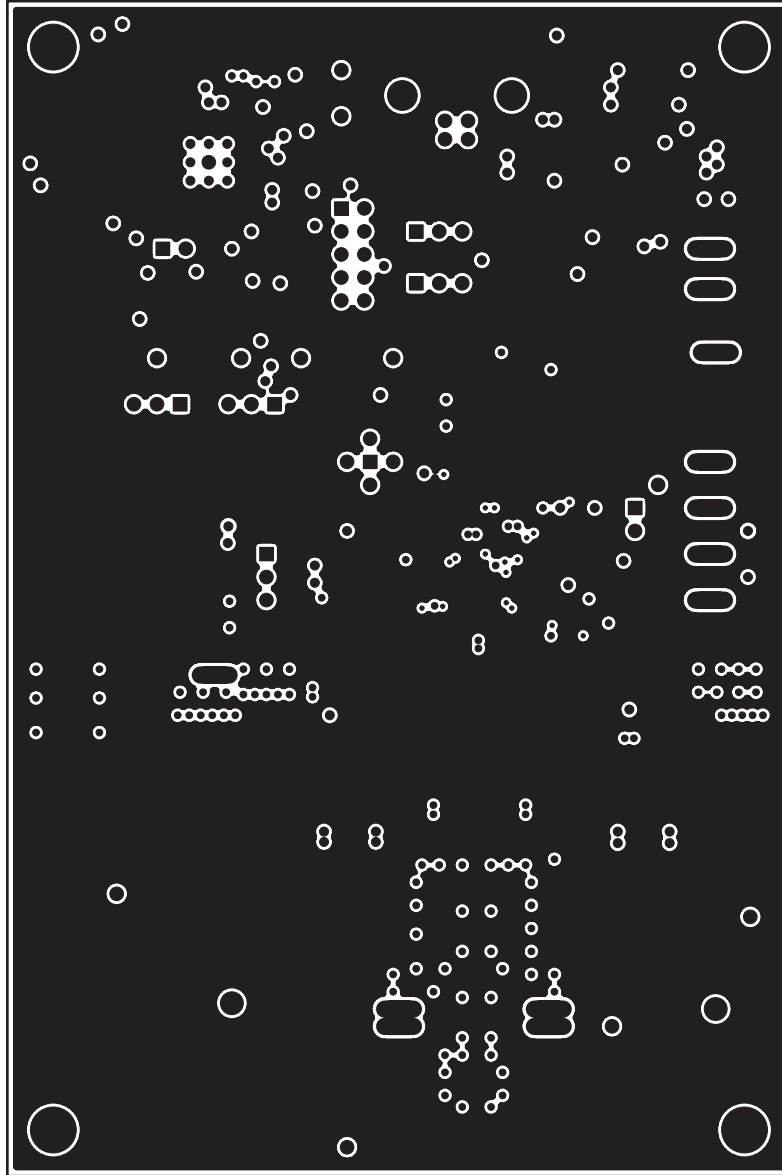

Figure 8. MAX17480 EV Kit PCB Layout—Internal Layer 5

MAX17480 Evaluation Kit

Evaluates: MAX17480

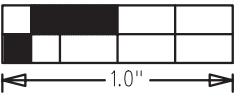
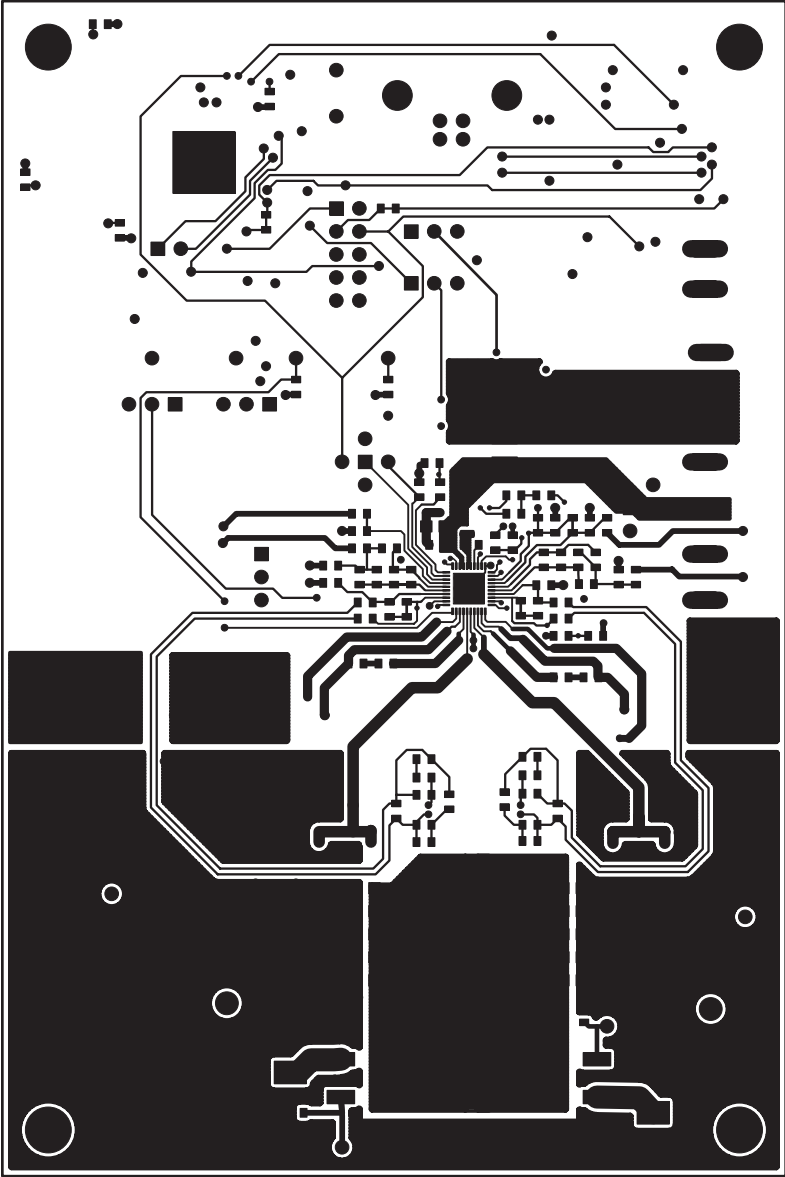

Figure 9. MAX17480 EV Kit PCB Layout—Solder Side

MAX17480 Evaluation Kit

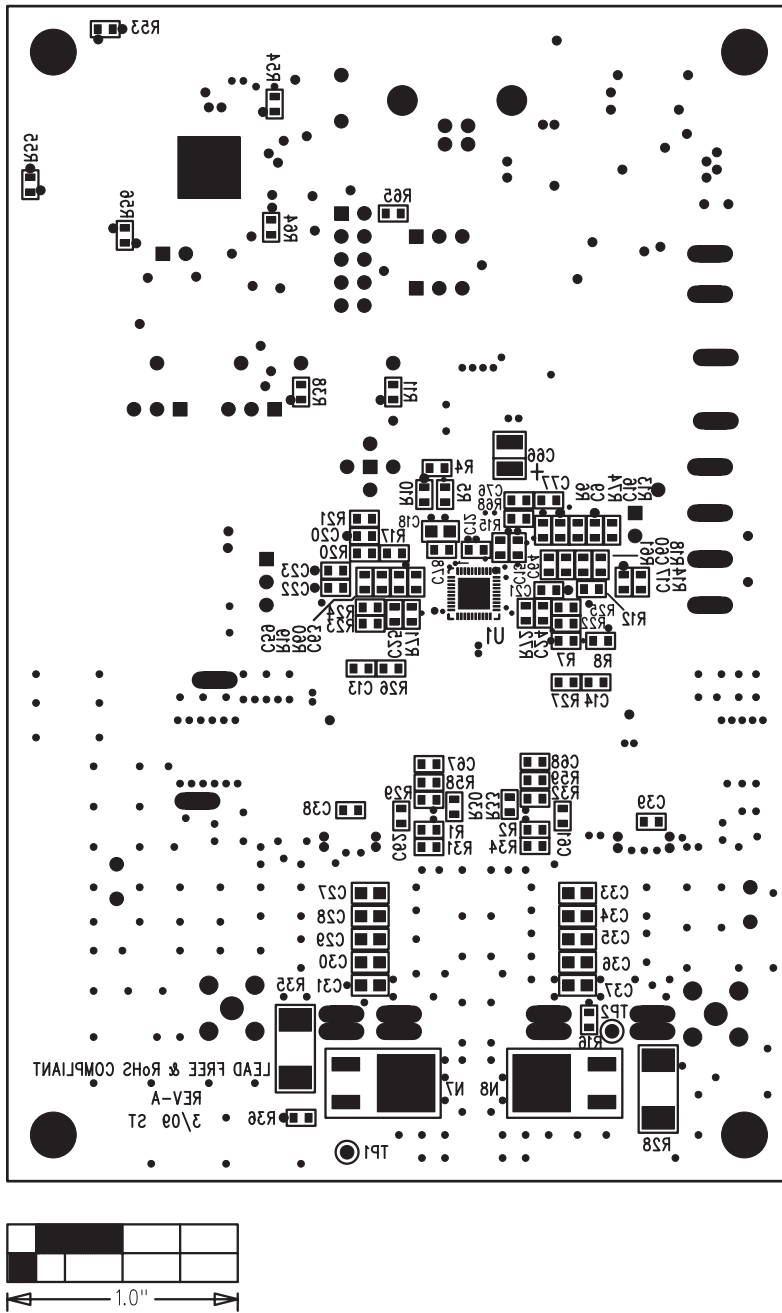

Figure 10. MAX17480 EV Kit Component Placement Guide—Solder Side

Maxim cannot assume responsibility for use of any circuitry other than circuitry entirely embodied in a Maxim product. No circuit patent licenses are implied. Maxim reserves the right to change the circuitry and specifications without notice at any time.



Компания «ЭлектроПласт» предлагает заключение долгосрочных отношений при поставках импортных электронных компонентов на взаимовыгодных условиях!

Наши преимущества:

- Оперативные поставки широкого спектра электронных компонентов отечественного и импортного производства напрямую от производителей и с крупнейших мировых складов;
- Поставка более 17-ти миллионов наименований электронных компонентов;
- Поставка сложных, дефицитных, либо снятых с производства позиций;
- Оперативные сроки поставки под заказ (от 5 рабочих дней);
- Экспресс доставка в любую точку России;
- Техническая поддержка проекта, помощь в подборе аналогов, поставка прототипов;
- Система менеджмента качества сертифицирована по Международному стандарту ISO 9001;
- Лицензия ФСБ на осуществление работ с использованием сведений, составляющих государственную тайну;
- Поставка специализированных компонентов (Xilinx, Altera, Analog Devices, Intersil, Interpoint, Microsemi, Aeroflex, Peregrine, Syfer, Eurofarad, Texas Instrument, Miteq, Cobham, E2V, MA-COM, Hittite, Mini-Circuits, General Dynamics и др.);

Помимо этого, одним из направлений компании «ЭлектроПласт» является направление «Источники питания». Мы предлагаем Вам помощь Конструкторского отдела:

- Подбор оптимального решения, техническое обоснование при выборе компонента;
- Подбор аналогов;
- Консультации по применению компонента;
- Поставка образцов и прототипов;
- Техническая поддержка проекта;
- Защита от снятия компонента с производства.



Как с нами связаться

Телефон: 8 (812) 309 58 32 (многоканальный)

Факс: 8 (812) 320-02-42

Электронная почта: org@eplast1.ru

Адрес: 198099, г. Санкт-Петербург, ул. Калинина, дом 2, корпус 4, литера А.