

CARMEN-W-B

~55° wide beam. Assembly with holder B compatible with Ø40 mm BJB connectors.

TECHNICAL SPECIFICATIONS:

Dimensions	Ø 69.5 mm
Height	36.3 mm
Fastening	socket
ROHS compliant	yes ⓘ

MATERIAL SPECIFICATIONS:

Component	Type	Material	Colour	Finish
CARMEN-W	Single lens	PMMA		
CARMEN-HLD-B	Holder	PC		



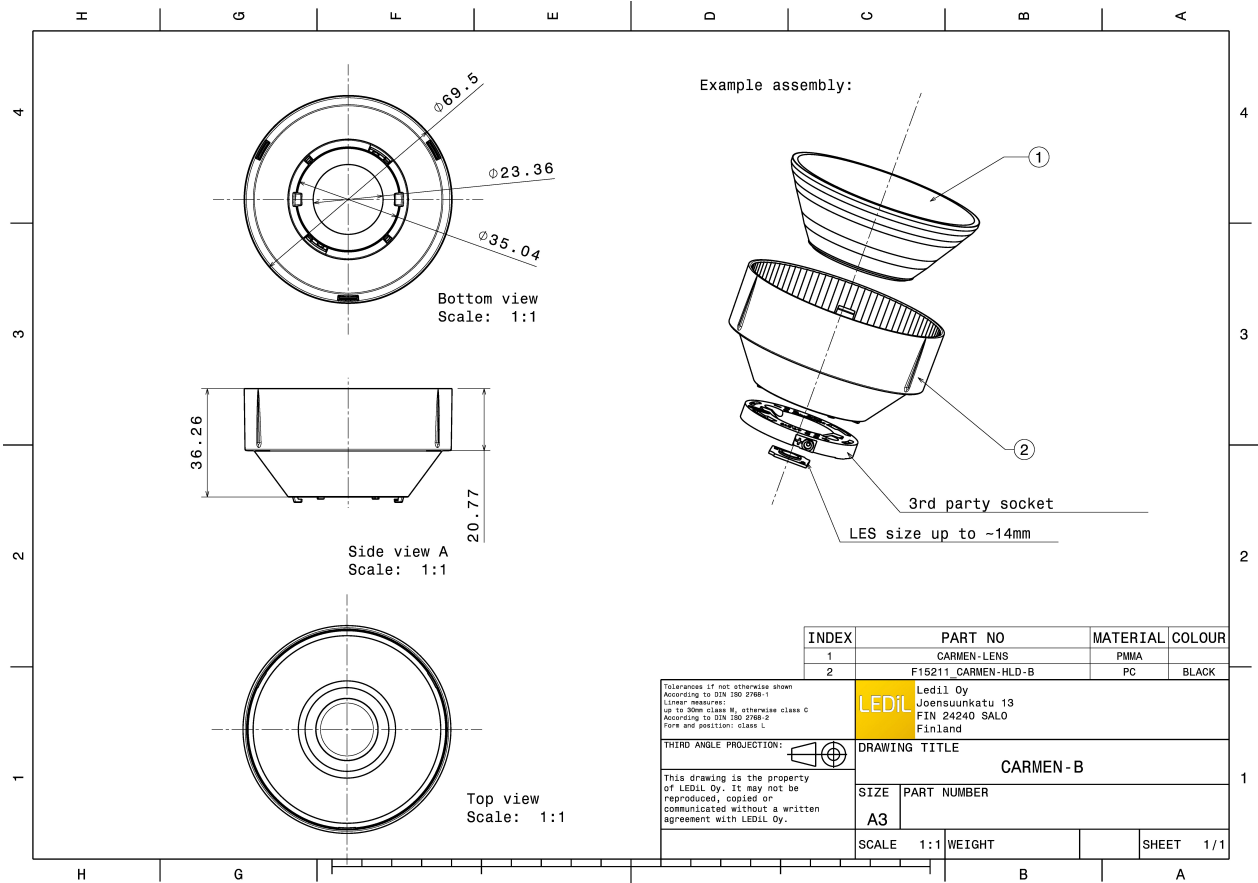

ORDERING INFORMATION:

Component		Qty in box	MOQ	MPQ	Box weight (kg)
CP15313_CARMEN-W-B	Single lens	150	150	15	6.0
» Box size: 476 x 273 x 292 mm					

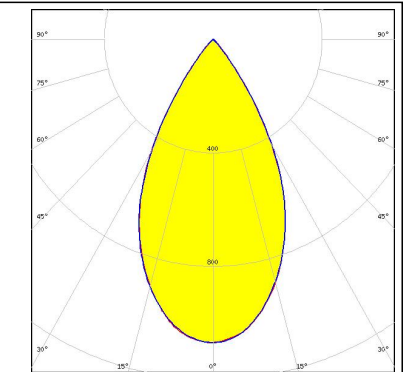
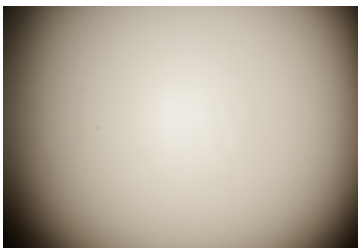
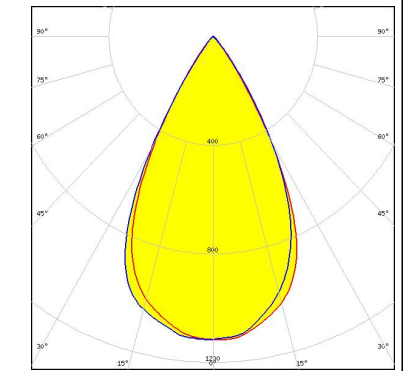

PHOTOMETRIC DATA (MEASURED):

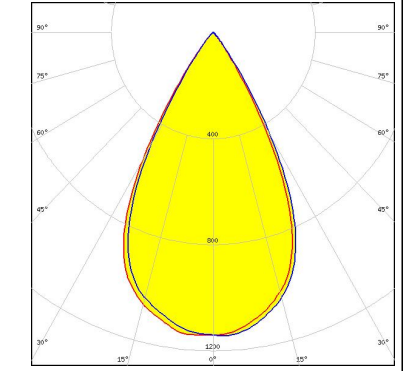
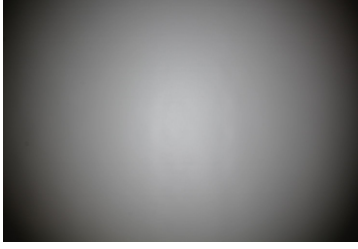
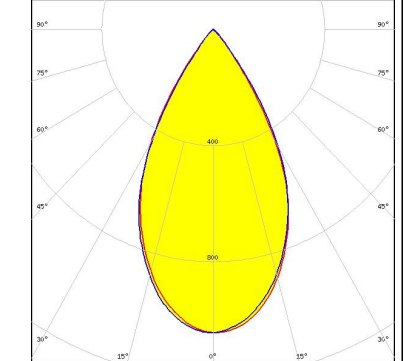
<p>bridgelux</p> <p>LED V10 Gen7 FWHM 55.0° Efficiency 81 % Peak intensity 1.100 cd/lm LEDs/each optic 1 Light colour White Required components: BJB: 47.319.6060</p>		
<p>CITIZEN</p> <p>LED CLU700/701/702 FWHM 56.0° Efficiency 86 % Peak intensity 1.100 cd/lm LEDs/each optic 1 Light colour White Required components: BJB: 47.319.6060</p>		
<p>CREE</p> <p>LED CXA/B 13xx FWHM 57.0° Efficiency 89 % Peak intensity 1.100 cd/lm LEDs/each optic 1 Light colour White Required components:</p>		
<p>SAMSUNG</p> <p>LED COB D Series LES 9.8 mm FWHM 56.0° Efficiency 82 % Peak intensity 1.040 cd/lm LEDs/each optic 1 Light colour White Required components: A.A.G. STUCCHI: 8100/G2</p>		

PHOTOMETRIC DATA (MEASURED):

SAMSUNG

LED COB D Series LES 9.8 mm
FWHM 56.0°
Efficiency 82 %
Peak intensity 1.040 cd/lm
LEDs/each optic 1
Light colour White
Required components:
BJB: 47.319.6060

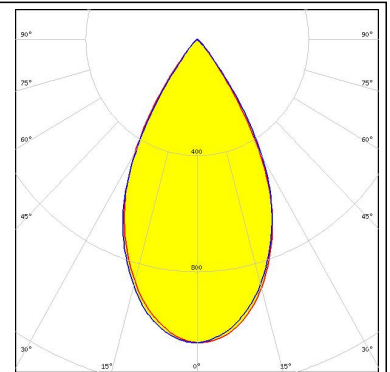

LED MJT COB LES 6
FWHM 55.0°
Efficiency 84 %
Peak intensity 1.100 cd/lm
LEDs/each optic 1
Light colour White
Required components:
BJB: 47.319.6060

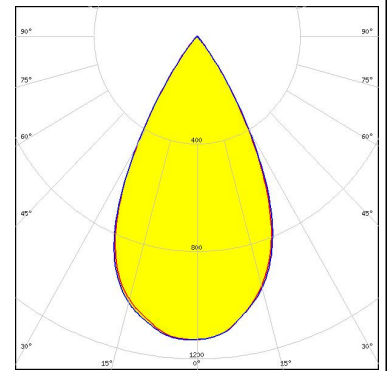
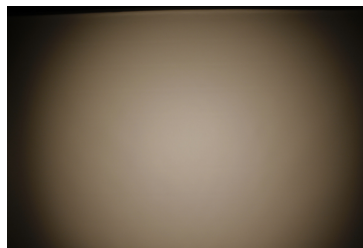

PHOTOMETRIC DATA (SIMULATED):

CITIZEN

LED CLL02x/CLU02x (LES10)
FWHM 55.0°
Efficiency 82 %
Peak intensity 1.200 cd/lm
LEDs/each optic 1
Light colour White
Required components:
BJB: 47.319.6060

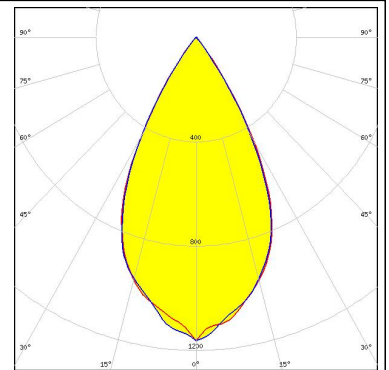

CITIZEN

LED CLL02x/CLU02x (LES10)
FWHM 55.0°
Efficiency 73 %
Peak intensity 0.960 cd/lm
LEDs/each optic 1
Light colour White
Required components:

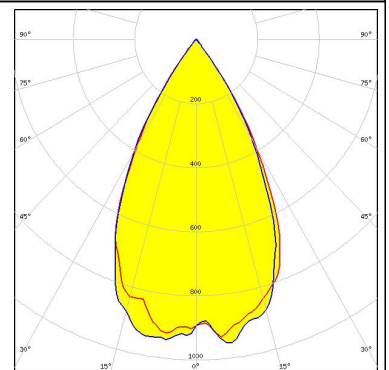

CREE

LED CXA/B 15xx
FWHM 53.0°
Efficiency 73 %
Peak intensity 0.969 cd/lm
LEDs/each optic 1
Light colour White
Required components:

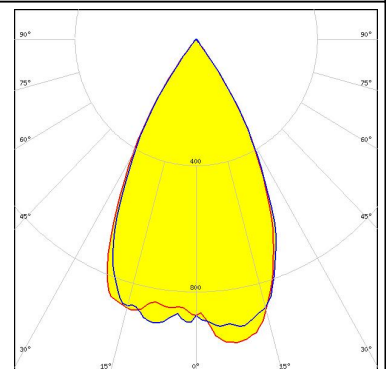

GENERAL INFORMATION:

NOTE: The typical beam angle will be changed by different color, chip size and chip position tolerance. The typical total beam angle is the full angle measured where the luminous intensity is half of the peak value.

Due to use of high power COB's with this product, special attention to proper thermal design is highly recommended. LEDiL has no liability for direct, indirect or consecutive damages arising from the LEDiL products being used outside of the recommended temperature range.

MATERIALS:

As part of our continuous research and improvement processes, and to ensure the best possible quality and availability of our products, LEDiL reserves the right to change material grades without notice.

PRODUCT DATA USER AGREEMENT AND DISCLAIMER:

The measured data in the provided downloadable LEDiL Product Datasheets and Mechanical 2D-Drawings is rounded and provided as reference for planning. LEDiL Oy's optical specifications have been verified by conducting performance testing of the products in accordance with the company's quality system. The reported data are averaged results of multiple measurements with typical variation. LEDiL Oy reserves the right to without prior notification make changes and improvements to its products.

LEDiL Oy assumes neither warranty, nor guarantee nor any other liability of any kind for the contents and correctness of the provided data. The provided data has been generated with highest diligence but the provided data may in reality not represent the complete possible variation range of all intrinsic parameters. Therefore, in certain cases a deviation from the provided data could occur.

LEDiL Oy reserves the right to undertake technical changes of its products without further notification which could lead to changes in the provided data. LEDiL Oy assumes no liability of any kind for the possible deviation from any provided data or any other damage resulting from the usage of the provided data.

The user agrees to this disclaimer and user agreement with the download or usage of the provided files.

LEDiL Oy

Joensuunkatu 13
FI-24240 SALO
Finland

LEDiL Inc.

228 West Page Street
Suite D
Sycamore IL 60178
USA

Local sales and technical support

www.ledil.com/where_to_buy

Shipping locations

Salo, Finland
Hong Kong, China

Distribution Partners

www.ledil.com/where_to_buy



Компания «ЭлектроПласт» предлагает заключение долгосрочных отношений при поставках импортных электронных компонентов на взаимовыгодных условиях!

Наши преимущества:

- Оперативные поставки широкого спектра электронных компонентов отечественного и импортного производства напрямую от производителей и с крупнейших мировых складов;
- Поставка более 17-ти миллионов наименований электронных компонентов;
- Поставка сложных, дефицитных, либо снятых с производства позиций;
- Оперативные сроки поставки под заказ (от 5 рабочих дней);
- Экспресс доставка в любую точку России;
- Техническая поддержка проекта, помощь в подборе аналогов, поставка прототипов;
- Система менеджмента качества сертифицирована по Международному стандарту ISO 9001;
- Лицензия ФСБ на осуществление работ с использованием сведений, составляющих государственную тайну;
- Поставка специализированных компонентов (Xilinx, Altera, Analog Devices, Intersil, Interpoint, Microsemi, Aeroflex, Peregrine, Syfer, Eurofarad, Texas Instrument, Miteq, Cobham, E2V, MA-COM, Hittite, Mini-Circuits, General Dynamics и др.);

Помимо этого, одним из направлений компании «ЭлектроПласт» является направление «Источники питания». Мы предлагаем Вам помощь Конструкторского отдела:

- Подбор оптимального решения, техническое обоснование при выборе компонента;
- Подбор аналогов;
- Консультации по применению компонента;
- Поставка образцов и прототипов;
- Техническая поддержка проекта;
- Защита от снятия компонента с производства.



Как с нами связаться

Телефон: 8 (812) 309 58 32 (многоканальный)

Факс: 8 (812) 320-02-42

Электронная почта: org@eplast1.ru

Адрес: 198099, г. Санкт-Петербург, ул. Калинина, дом 2, корпус 4, литера А.