

ISOLATED DC/DC CONVERTERS

48 Vdc Input, 1.2 Vdc - 12 Vdc / 15 A - 3 A Outputs, 1/16 Brick Converter

Apr. 09, 2010

Bel Power Inc., a subsidiary of Bel Fuse Inc.

xRSB-30T Series

RoHS Compliant

Rev.B

- Isolated
- Fixed Frequency (550 kHz)
- High Efficiency
- High Power Density
- Low Cost
- Output Voltage Trim
- Basic Insulation
- UL60950-1 Recognized (UL/cUL)
- Input Under-Voltage Lockout
- Output Over-Voltage Shutdown
- OCP/SCP
- Over Temperature Protection
- Remote On/Off (Option)
- Positive/Negative Remote Sense
- Through Hole and SMT(Option)

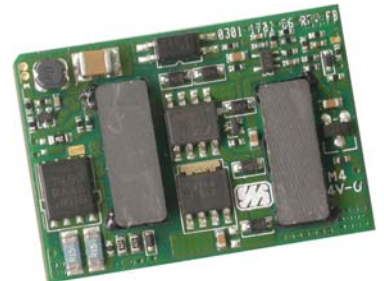

Description

The xRSB-30T series are isolated dc/dc converters that operate from a nominal 48 Vdc source. These units will provide up to 30 W of output power from a nominal 48 Vdc input. These units are designed to be highly efficient and low cost. Features include remote on/off, over current protection and under voltage lockout. These converters are provided in an industry standard sixteenth brick package.

Part Selection

Output Voltage	Input Voltage	Max. Output Current	Max. Output Power	Typical Efficiency	Model Number Active Low	Model Number Active High
1.2 Vdc	36 Vdc - 75 Vdc	15 A	18 W	84%	xRSB-30TV2L	xRSB-30TV20
1.5 Vdc	36 Vdc - 75 Vdc	13 A	19.5 W	86%	xRSB-30TV5L	xRSB-30TV50
1.8 Vdc	36 Vdc - 75 Vdc	13 A	23 W	86%	xRSB-30TV8L	xRSB-30TV80
2.5 Vdc	36 Vdc - 75 Vdc	10 A	25 W	89%	xRSB-30T02L	xRSB-30T025
3.3 Vdc	36 Vdc - 75 Vdc	10 A	30 W	90%	xRSB-30T03L	xRSB-30T033
5.0 Vdc	36 Vdc - 75 Vdc	7 A	35 W	90%	xRSB-30T05L	xRSB-30T050
12 Vdc	36 Vdc - 75 Vdc	3 A	36 W	89%	xRSB-30T12L	xRSB-30T120

Notes: 1. Add "G" suffix at the end of the model number to indicate Tray Packaging. Replace "x" with "S" to indicate SMT package, or "0" to indicate through hole package.

2. All part numbers above indicate RoHS 6. Change the second letter "R" to "7" for RoHS 5 part numbers

Absolute Maximum Ratings

Parameter	Min	Typ	Max	Notes
Input Voltage (continuous)	-0.3 V	-	80 V	
Input Voltage Transient (100 ms)	-0.3 V		100 V	
Remote On/Off	-0.3 V	-	18 V	
I/O Isolation Voltage	-	-	1500 V	
Ambient Temperature	-40 °C	-	85 °C	
Storage Temperature	-55 °C	-	125 °C	

ISOLATED DC/DC CONVERTERS

48 Vdc Input, 1.2 Vdc - 12 Vdc / 15 A - 3 A Outputs, 1/16 Brick Converter



Apr. 09, 2010

Bel Power Inc., a subsidiary of Bel Fuse Inc.

Input Specifications

Parameter	Min	Typ	Max	Notes
Input Voltage	36 V	48 V	75 V	
Input Current (full load)	-	-	1.6 A	
Input Current (no load)	-	30 mA	120 mA	
Remote Off Input Current	-	2 mA	6 mA	
Input Reflected Ripple Current (pk-pk)	-	20 mA	50 mA	Tested with simulated source impedance of 15 μ H, 5 Hz to 20 MHz; use a 100 μ F/100 V electrolytic capacitor with ESR=1 ohm max at 200 kHz at the input.
Input Reflected Ripple Current (rms)	-	3 mA	7 mA	
I ² t Inrush Current Transient	-	0.01 A ² s	0.02 A ² s	
Turn On Voltage Threshold	31 V	33 V	35 V	
Turn Off Voltage Threshold	28 V	32 V	35 V	

Note: All specifications are typical at nominal input, full load at 25 °C unless otherwise stated.

Output Specifications

Parameter	Min	Typ	Max	Notes
Output Voltage Set Point				Test conditions: Vin=48 V; Io=50% load
Vo=1.2 V	1.182 V	1.2 V	1.218 V	
Vo=1.5 V	1.478 V	1.5 V	1.523 V	
Vo=1.8 V	1.773 V	1.8 V	1.827 V	
Vo=2.5 V	2.463 V	2.5 V	2.538 V	
Vo=3.3 V	3.250 V	3.3 V	3.350 V	
Vo=5.0 V	4.900 V	5.0 V	5.100 V	
Vo=12 V	11.750 V	12.0 V	12.250 V	
Line Regulation				
Vo=1.2 - 1.8 V	-	±0.5 mV	±3 mV	
Vo=2.5 V	-	±2.0 mV	±6 mV	
Vo=3.3 V	-	±3.0 mV	±8 mV	
Vo=5.0 V	-	±4.0 mV	±9 mV	
Vo=12 V	-	±6.0 mV	±20 mV	
Load Regulation				
Vo=1.2 - 2.5 V	-	±3 mV	±5 mV	
Vo=3.3 - 5.0 V	-	±4 mV	±9 mV	
Vo=12 V	-	±5 mV	±10 mV	
Regulation Over Temperature (-40 °C to +85 °C)				
Vo=1.2 - 1.8 V	-	±7 mV	±15 mV	
Vo=2.5 - 3.3 V	-	±9 mV	±16 mV	
Vo=5.0 V	-	±15 mV	±30 mV	
Vo=12 V	-	±20 mV	±35 mV	
Output Current				
Vo=1.2 V	0 A	-	15 A	
Vo=1.5 V	0 A	-	13 A	
Vo=1.8 V	0 A	-	13 A	
Vo=2.5 V	0 A	-	10 A	
Vo=3.3 V	0 A	-	10 A	
Vo=5.0 V	0 A	-	7 A	
Vo=12 V	0 A	-	3 A	

ISOLATED DC/DC CONVERTERS

48 Vdc Input, 1.2 Vdc - 12 Vdc / 15 A - 3 A Outputs, 1/16 Brick Converter



Apr. 09, 2010

Bel Power Inc., a subsidiary of Bel Fuse Inc.

Output Specifications (continued)

Parameter		Min	Typ	Max	Notes	
Current Limit Threshold	Vo=1.2 V	18 A	24 A	30 A		
	Vo=1.5 V	14 A	20 A	26 A		
	Vo=1.8 V	14 A	19 A	24 A		
	Vo=2.5 V	11 A	16 A	21 A		
	Vo=3.3 V	10.5 A	15.5 A	25 A		
	Vo=5.0 V	7.5 A	9.5 A	14 A		
	Vo=12 V	3.5 A	4.5 A	6 A		
Short Circuit Surge Transient		-	0.5 A ² s	1 A ² s		
Ripple and Noise (rms)	Vo=1.2 - 2.5 V	-	10 mV	20 mV	Tested at 0-20 MHz BW, with a 1 uF ceramic capacitor and a 10 uF Tantalum capacitor at the output.	
	Vo=3.3 V	-	15 mV	30 mV		
	Vo=5.0 - 12 V	-	30 mV	55 mV		
Ripple and Noise (pk-pk)	Vo=1.2 - 2.5 V	-	40 mV	70 mV		
	Vo=3.3 V	-	65 mV	110 mV		
	Vo=5.0 V	-	90 mV	150 mV		
	Vo=12 V	-	80 mV	140 mV		
Turn on Time		-	35 mS	70 mS		
Overshoot at Turn on		-	0%	5%		
Output Capacitance	Vo=1.2 - 1.5 V	220 uF	-	15000 uF		
	Vo=1.8 V	220 uF	-	10000 uF		
	Vo=2.5 V	220 uF	-	6800 uF		
	Vo=3.3 V	0 uF	-	4700 uF		
	Vo=5.0 V	0 uF	-	2200 uF		
	Vo=12 V	0 uF	-	330 uF		
Transient Response						
25% ~ 50% Max Load	Overshoot	Vo=1.2 V	-	100 mV	150 mV	Test conditions: di/dt = 0.1 A/uS, Vin=48 V, with a 1uF ceramic capacitor and a 10 uF Tantalum capacitor at the output.
	Settling Time		-	100 uS	150 uS	
50% ~ 25% Max Load	Overshoot	Vo=1.2 V	-	100 mV	150 mV	
	Settling Time		-	100 uS	150 uS	
25% ~ 50% Max Load	Overshoot	Vo=1.5 - 1.8 V	-	150 mV	200 mV	
	Settling Time		-	120 uS	200 uS	
50% ~ 25% Max Load	Overshoot	Vo=1.5 - 1.8 V	-	150 mV	200 mV	
	Settling Time		-	120 uS	200 uS	
25% ~ 50% Max Load	Overshoot	Vo=2.5 V	-	200 mV	300 mV	
	Settling Time		-	100 uS	150 uS	
50% ~ 25% Max Load	Overshoot	Vo=2.5 V	-	200 mV	300 mV	
	Settling Time		-	100 uS	150 uS	
25% ~ 50% Max Load	Overshoot	Vo=3.3 V	-	200 mV	350 mV	
	Settling Time		-	200 uS	350 uS	
50% ~ 25% Max Load	Overshoot	Vo=3.3 V	-	200 mV	350 mV	
	Settling Time		-	200 uS	350 uS	
25% ~ 50% Max Load	Overshoot	Vo=5.0 V	-	350 mV	500 mV	
	Settling Time		-	200 uS	350 uS	
50% ~ 25% Max Load	Overshoot	Vo=5.0 V	-	350 mV	500 mV	
	Settling Time		-	200 uS	350 uS	
25% ~ 50% Max Load	Overshoot	Vo=12 V	-	270 mV	450 mV	
	Settling Time		-	110 uS	200 uS	
50% ~ 25% Max Load	Overshoot	Vo=12 V	-	270 mV	450 mV	
	Settling Time		-	110 uS	200 uS	

Note: All specifications are typical at nominal input, full load at 25 °C unless otherwise stated.

ISOLATED DC/DC CONVERTERS

48 Vdc Input, 1.2 Vdc - 12 Vdc / 15 A - 3 A Outputs, 1/16 Brick Converter



Apr. 09, 2010

Bel Power Inc., a subsidiary of Bel Fuse Inc.

General Specifications

Parameter	Min	Typ	Max	Notes
Efficiency				
Vo=1.2 V	81%	84%	-	Vin=48 V, full load
Vo=1.5 V	83%	86%	-	
Vo=1.8 V	83%	86%	-	
Vo=2.5 V	84%	87%	-	
Vo=3.3 - 5.0 V	87%	90%	-	
Vo=12 V	86%	89%	-	
Switching Frequency	500 kHz	550 kHz	600 kHz	
Isolation Capacitance	-	3900 pF	-	
Output Voltage Trim Range	90% Vo	-	110% Vo	
Over Temperature Protection	120 °C	-	140 °C	
Over Voltage Protection	-	130% Vo	160% Vo	Test conditions: Vin=48 V, full load and short the feedback optocoupler.
MTBF	TBD			Calculated Per Bell Core SR-332 (Io = Nominal; Ta = 25 °C)
Dimensions				SMT Package
Inches (L x W x H)	1.3 x 0.9 x 0.364			
Millimeters (L x W x H)	33.02 x 22.86 x 9.24			
Dimensions				Through Hole Package
Inches (L x W x H)	1.3 x 0.9 x 0.388			
Millimeters (L x W x H)	33.02 x 22.86 x 9.85			
Weight	-	13 g	-	

Note: All specifications are typical at 25 °C unless otherwise stated.

Control Specifications

Parameter	Min	Typ	Max	Notes
Remote On/Off				
Signal Low (Unit On)	-0.3 V	-	0.8 V	When Remote On/Off pin is open, for active low option, unit is off; for active high option, unit is on
Signal High (Unit Off)				
Signal Low (Unit Off)	-0.3 V	-	0.8 V	
Signal High (Unit On)				
Current Sink	-	0 mA	1 mA	

ISOLATED DC/DC CONVERTERS

48 Vdc Input, 1.2 Vdc - 12 Vdc / 15 A - 3 A Outputs, 1/16 Brick Converter



Apr. 09, 2010

Bel Power Inc., a subsidiary of Bel Fuse Inc.

Output Trim Equations

Equations for calculating the trim resistor are shown below (Unit: kΩ). The Trim Down resistor should be connected between the Trim pin and Ground pin. The Trim Up resistor should be connected between the Trim pin and the Vout. Only one of the resistors should be used for any given application.

1) Trim Equations for Vo=1.2 V

$$R_{trimdown} = \frac{511}{|\delta|} - 10.22$$

$$R_{trimup} = \frac{(100 + \delta) \cdot V_o \cdot 5.11 - 313}{0.6125 \cdot \delta} - 10.22$$

Note:
$$\delta = \frac{(V_o_{req} - V_o)}{V_o} \times 100[\%]$$

V_{o_req}=Desired (trimmed) output voltage [V] V_o=1.202 V

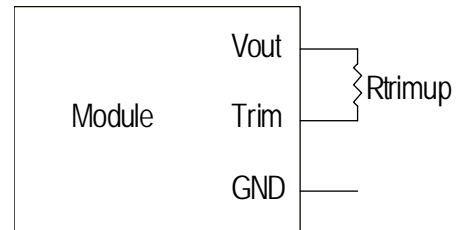
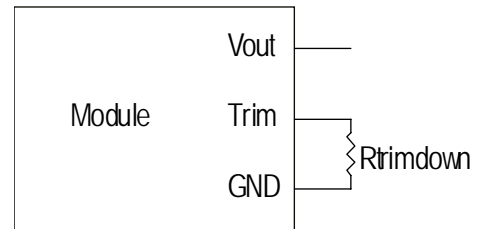

2) Trim Equations for Vo=1.5 V - 12 V

$$R_{trimdown} = \frac{511}{|\delta|} - 10.22$$

$$R_{trimup} = \frac{(100 + \delta) \cdot V_o \cdot 5.11 - 626}{1.225 \cdot \delta} - 10.22$$

Note:
$$\delta = \frac{(V_o_{req} - V_o)}{V_o} \times 100[\%]$$

V_{o_req}=Desired (trimmed) output voltage [V]

V_o=1.503 V for 1.5 V output; V_o=1.804 V for 1.8 V output; V_o=2.505 V for 2.5 V output; V_o=3.308 V for 3.3 V output; V_o=5.002 V for 5 V output; V_o=12.007 V for 12 V output.

ISOLATED DC/DC CONVERTERS

48 Vdc Input, 1.2 Vdc - 12 Vdc / 15 A - 3 A Outputs, 1/16 Brick Converter



Apr. 09, 2010

Bel Power Inc., a subsidiary of Bel Fuse Inc.

Efficiency Data

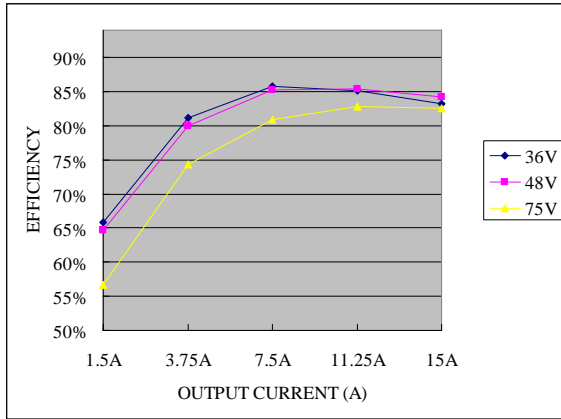

Vo=1.2 V

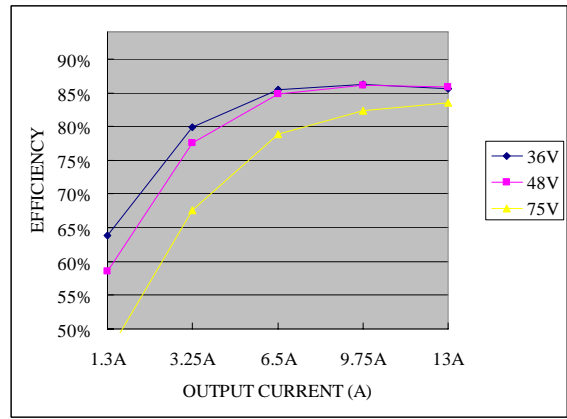

Vo=1.5 V

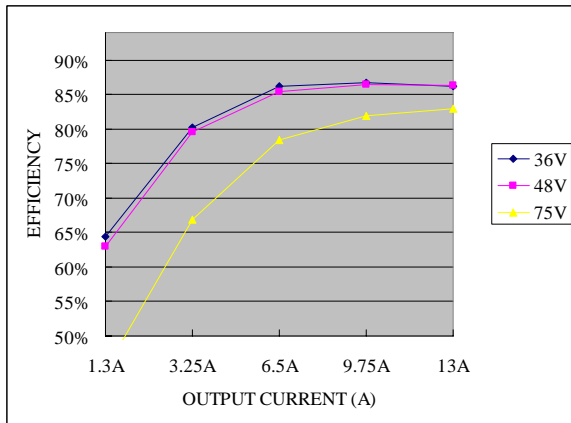

Vo=1.8 V

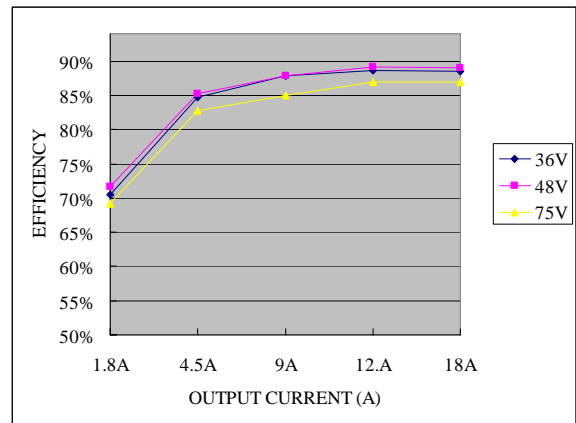

Vo=2.5 V

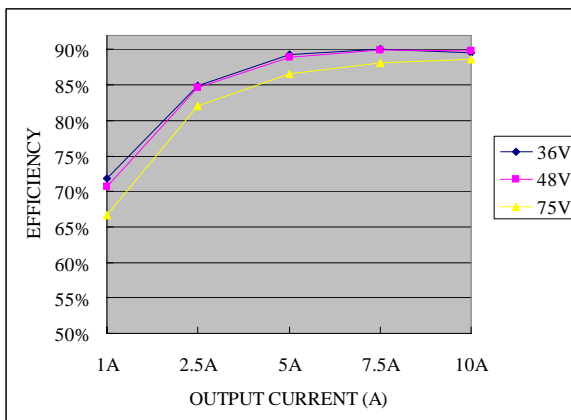

Vo=3.3 V

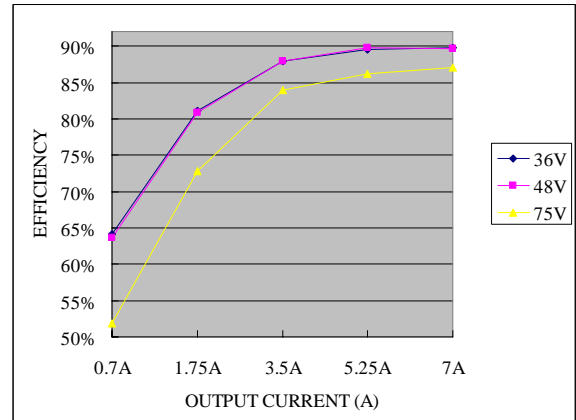

Vo=5.0 V

ISOLATED DC/DC CONVERTERS

48 Vdc Input, 1.2 Vdc - 12 Vdc / 15 A - 3 A Outputs, 1/16 Brick Converter



Apr. 09, 2010

Bel Power Inc., a subsidiary of Bel Fuse Inc.

Efficiency Data (continued)

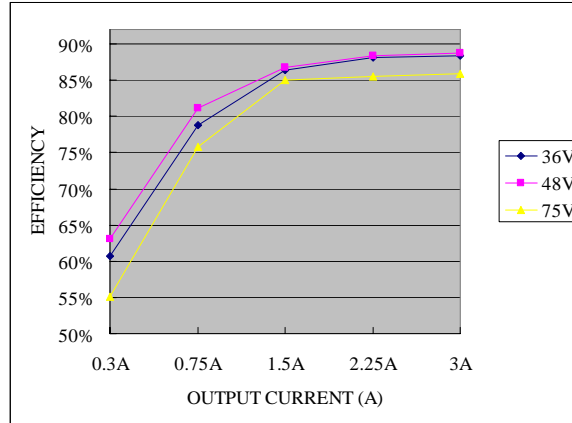

Vo=12 V

Thermal Derating Curves

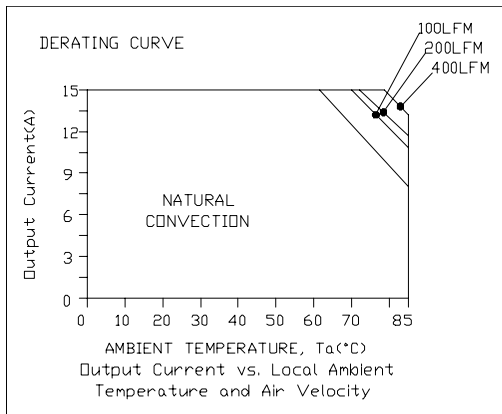

Vin=48 V, Vo=1.2 V

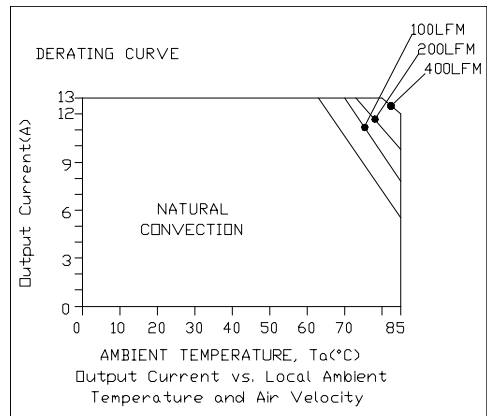

Vin=48 V, Vo=1.5 V

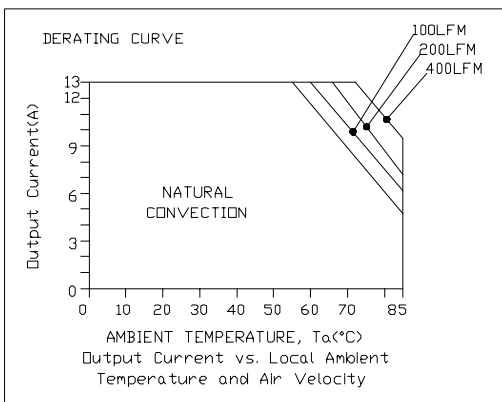

Vin=48 V, Vo=1.8 V

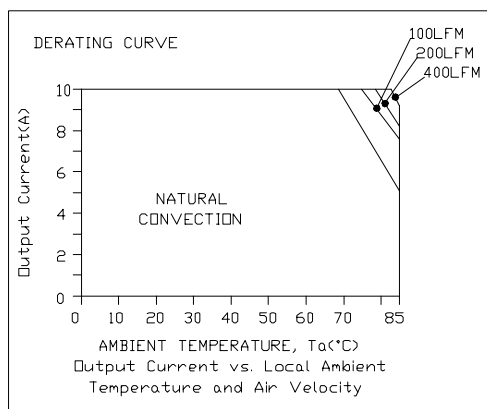

Vin=48 V, Vo=2.5 V

ISOLATED DC/DC CONVERTERS

48 Vdc Input, 1.2 Vdc - 12 Vdc / 15 A - 3 A Outputs, 1/16 Brick Converter



Apr. 09, 2010

Bel Power Inc., a subsidiary of Bel Fuse Inc.

Thermal Derating Curves (continued)

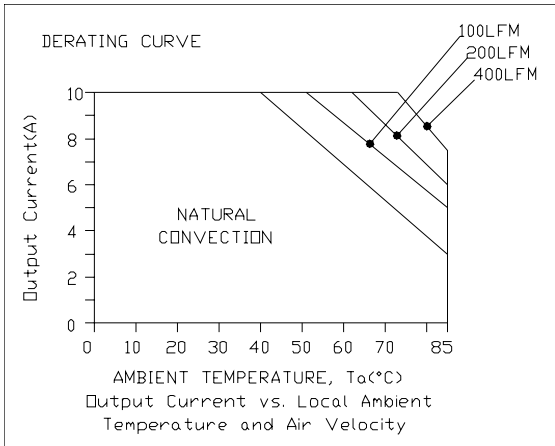

Vin=48 V, Vo=3.3 V

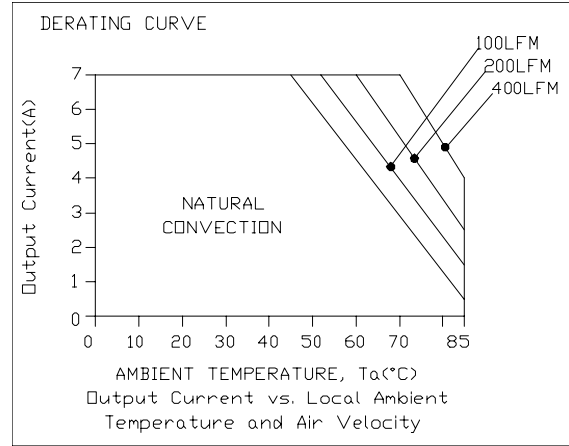

Vin=48 V, Vo=5.0 V

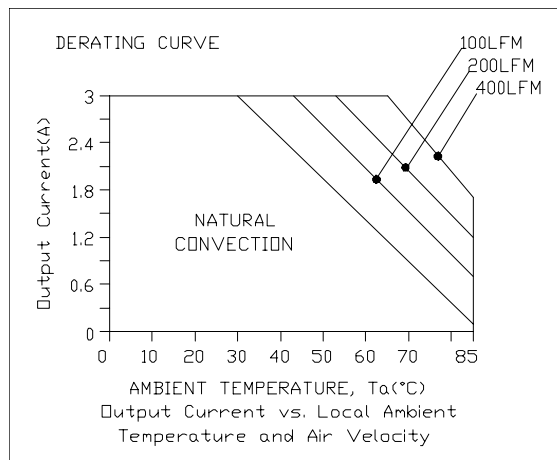

Vin=48 V, Vo=12 V

ISOLATED DC/DC CONVERTERS

48 Vdc Input, 1.2 Vdc - 12 Vdc / 15 A - 3 A Outputs, 1/16 Brick Converter



Apr. 09, 2010

Bel Power Inc., a subsidiary of Bel Fuse Inc.

Ripple and Noise Waveforms

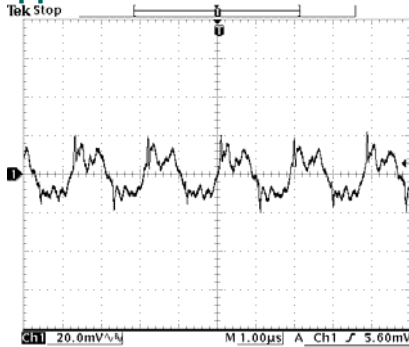

Ch1 Pk-Pk
42.0mV
Ch1 RMS
8.97mV

10 Oct 2005
09:24:37

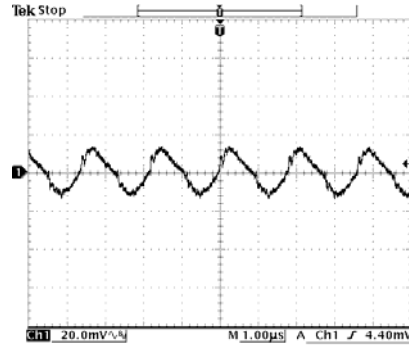

Ch1 Pk-Pk
27.6mV
Ch1 RMS
7.75mV

10 Jan 2006
13:53:48

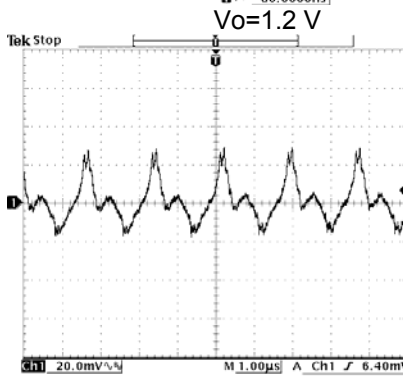

Vo=1.2 V

Ch1 Pk-Pk
46.8mV
Ch1 RMS
10.0mV

5 Jan 2006
10:58:04

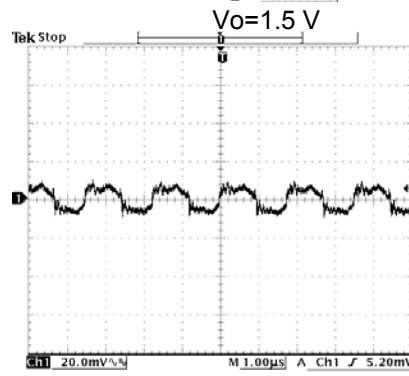

Vo=1.5 V

Ch1 Pk-Pk
20.0mV
Ch1 RMS
5.31mV

12 Apr 2006
14:44:38

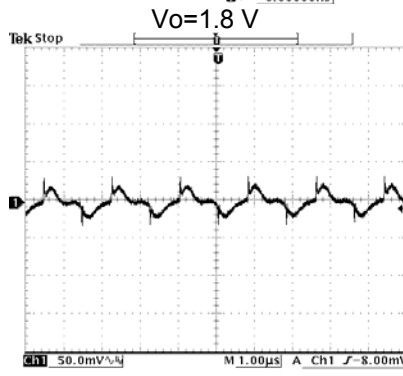

Vo=1.8 V

Ch1 Pk-Pk
65.0mV
Ch1 RMS
11.0mV

7 Nov 2005
15:52:33

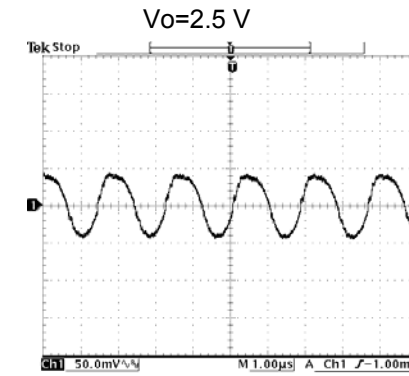

Vo=2.5 V

Ch1 Pk-Pk
89.0mV
Ch1 RMS
30.6mV

21 Nov 2005
14:40:50

Vo=3.3 V

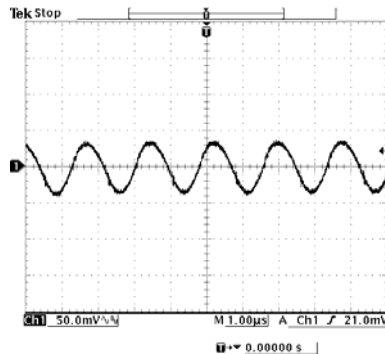

Ch1 Pk-Pk
78.0mV
Ch1 RMS
24.6mV

17 Oct 2005
11:18:01

Vo=12 V

Vo=5.0 V

Note: Ripple and noise at full load, 48 V input, with a 1 μ F ceramic capacitor and a 10 μ F tantalum cap at the output, and $T_a=25$ deg C.

ISOLATED DC/DC CONVERTERS

48 Vdc Input, 1.2 Vdc - 12 Vdc / 15 A - 3 A Outputs, 1/16 Brick Converter



Apr. 09, 2010

Bel Power Inc., a subsidiary of Bel Fuse Inc.

Transient Response Waveforms

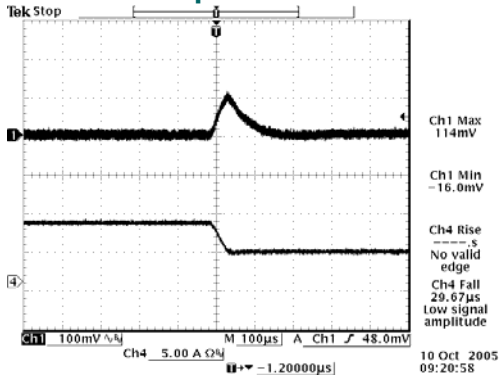

Vo=1.2 V 50% to 25% Load Transients

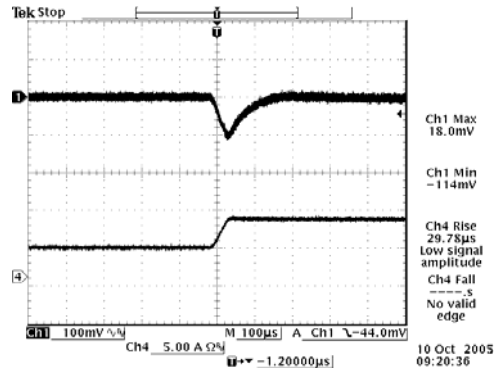

Vo=1.2 V 25% to 50% Load Transients

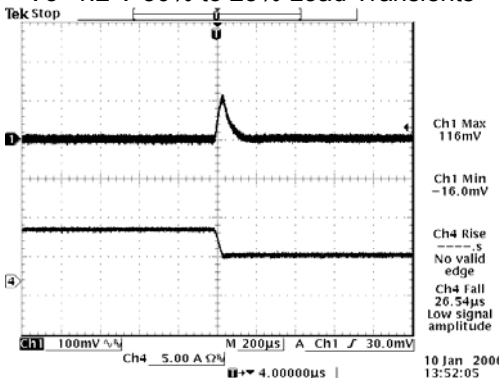

Vo=1.5 V 50% to 25% Load Transients

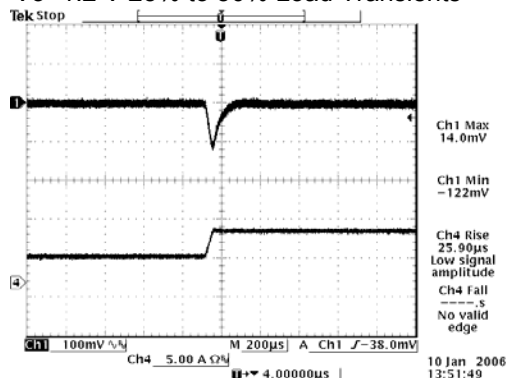

Vo=1.5 V 25% to 50% Load Transients

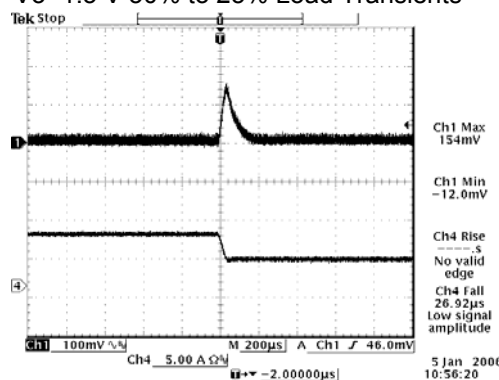

Vo=1.8 V 50% to 25% Load Transients

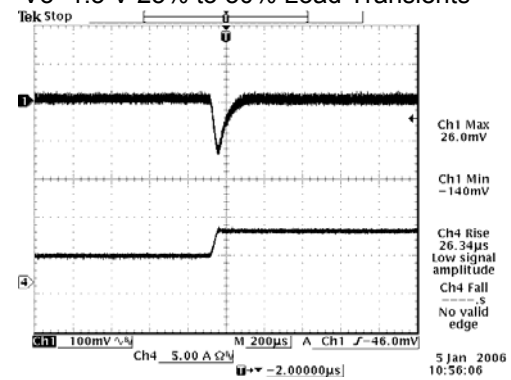

Vo=1.8 V 25% to 50% Load Transients

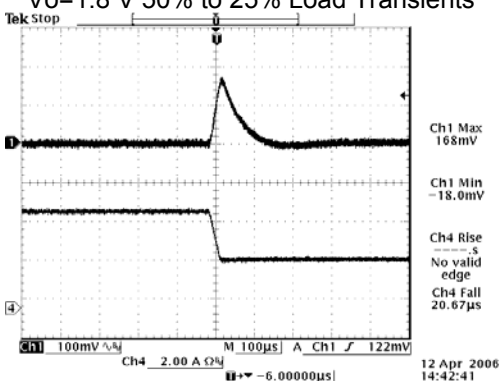

Vo=2.5 V 50% to 25% Load Transients

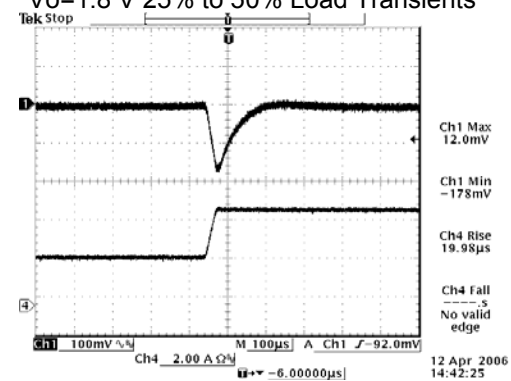

Vo=2.5 V 25% to 50% Load Transients

ISOLATED DC/DC CONVERTERS

48 Vdc Input, 1.2 Vdc - 12 Vdc / 15 A - 3 A Outputs, 1/16 Brick Converter



Apr. 09, 2010

Bel Power Inc., a subsidiary of Bel Fuse Inc.

Transient Response Waveforms (continued)

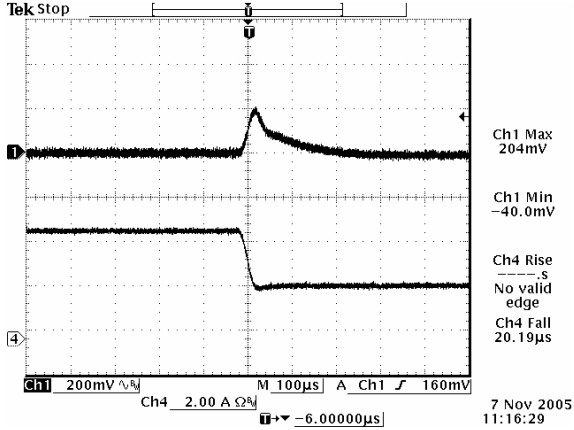

Vo=3.3 V 50% to 25% Load Transients

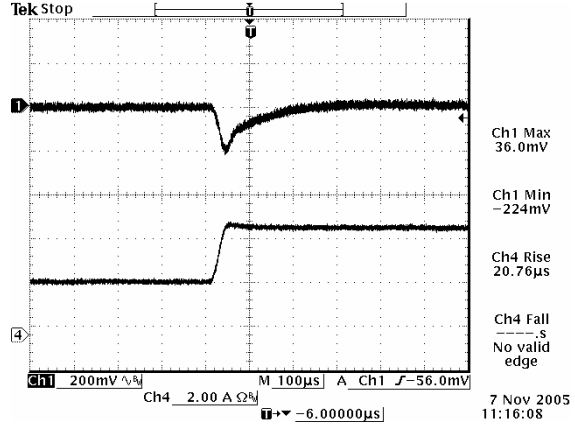

Vo=3.3 V 25% to 50% Load Transients

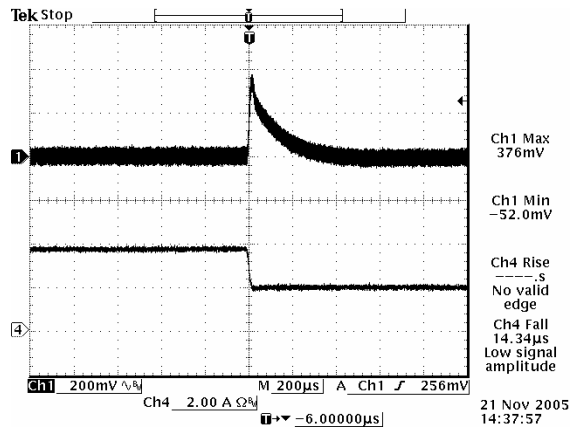

Vo=5.0 V 50% to 25% Load Transients

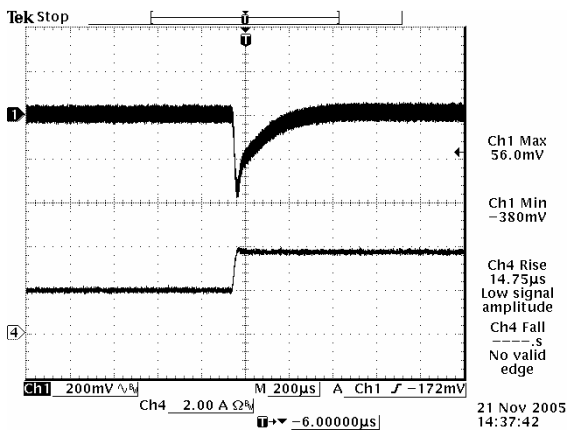

Vo=5.0 V 25% to 50% Load Transients

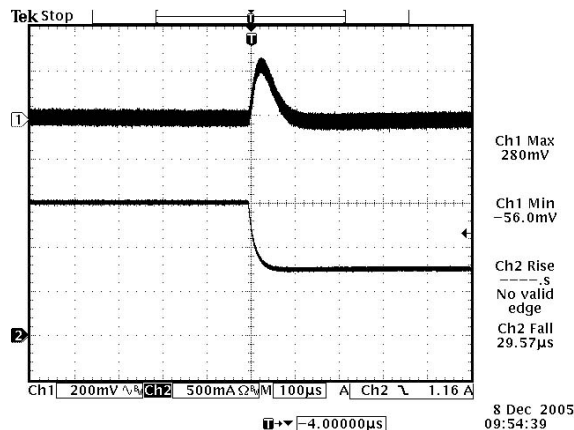

Vo=12 V 50% to 25% Load Transients

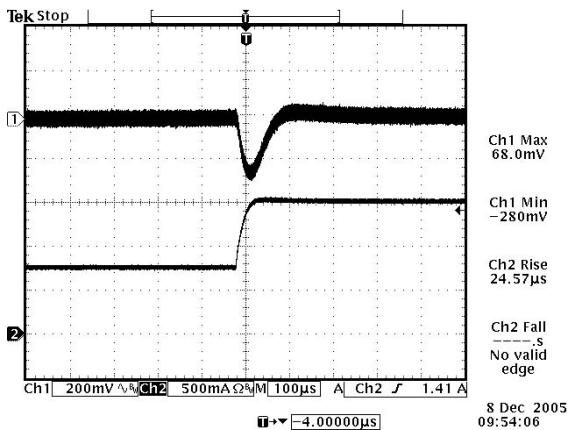

Vo=12 V 25% to 50% Load Transients

Note: Transient Response at Vin=48 V, di/dt=0.1A/uS, with external 220 uF tantalum capacitor and 1 uF ceramic capacitor, and Ta=25 deg C.

ISOLATED DC/DC CONVERTERS

48 Vdc Input, 1.2 Vdc - 12 Vdc / 15 A - 3 A Outputs, 1/16 Brick Converter



Apr. 09, 2010

Bel Power Inc., a subsidiary of Bel Fuse Inc.

Mechanical Outline

SMT Package

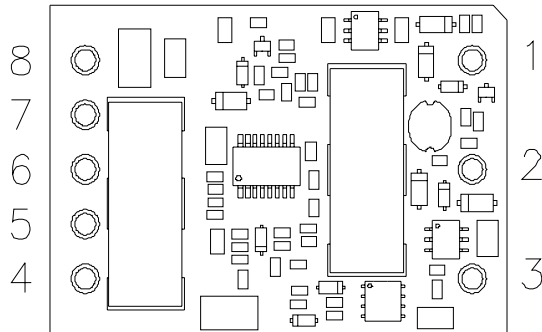
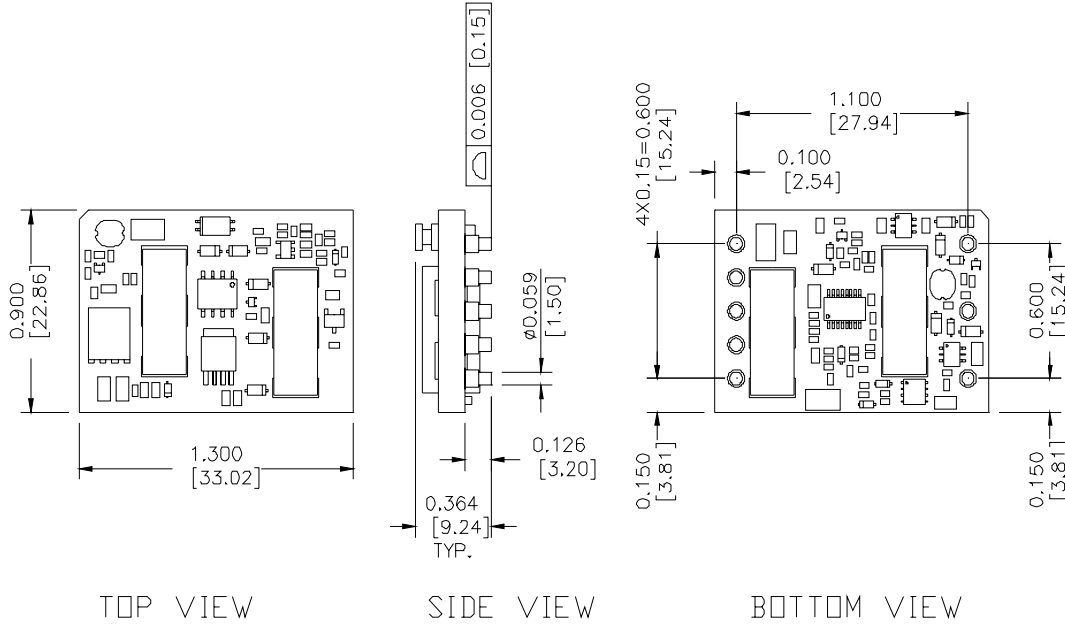

RECOMMENDED PCB PAD LAYOUT

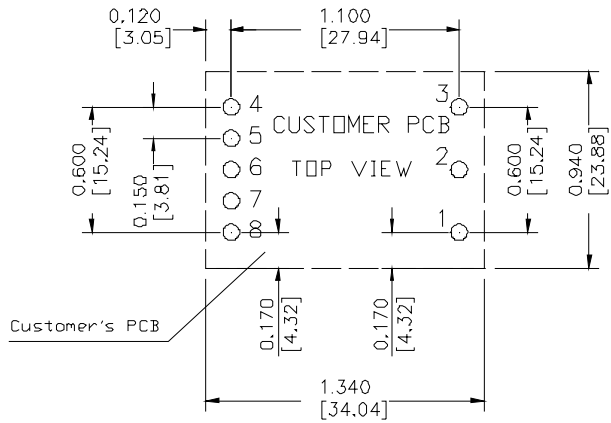

Recommended Surface Mount Pads
 Min. $\phi 0.080$ " [2.03]
 Max. $\phi 0.092$ " [2.34]

Pin Connections

Pin	Function
1	Vin (+)
2	Remote On/Off
3	Vin (-)
4	Vout-
5	Remote Sense (-)
6	Trim
7	Remote Sense (+)
8	Vout (+)

ISOLATED DC/DC CONVERTERS

48 Vdc Input, 1.2 Vdc - 12 Vdc / 15 A - 3 A Outputs, 1/16 Brick Converter



Apr. 09, 2010

Bel Power Inc., a subsidiary of Bel Fuse Inc.

Mechanical Outline (continued)

Through Hole Package

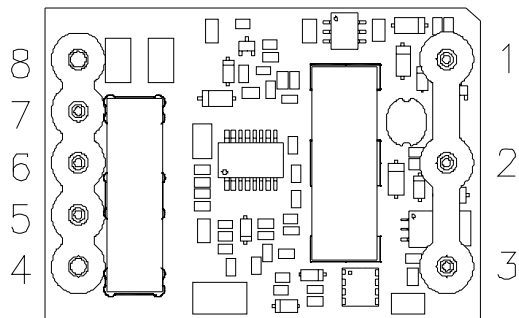
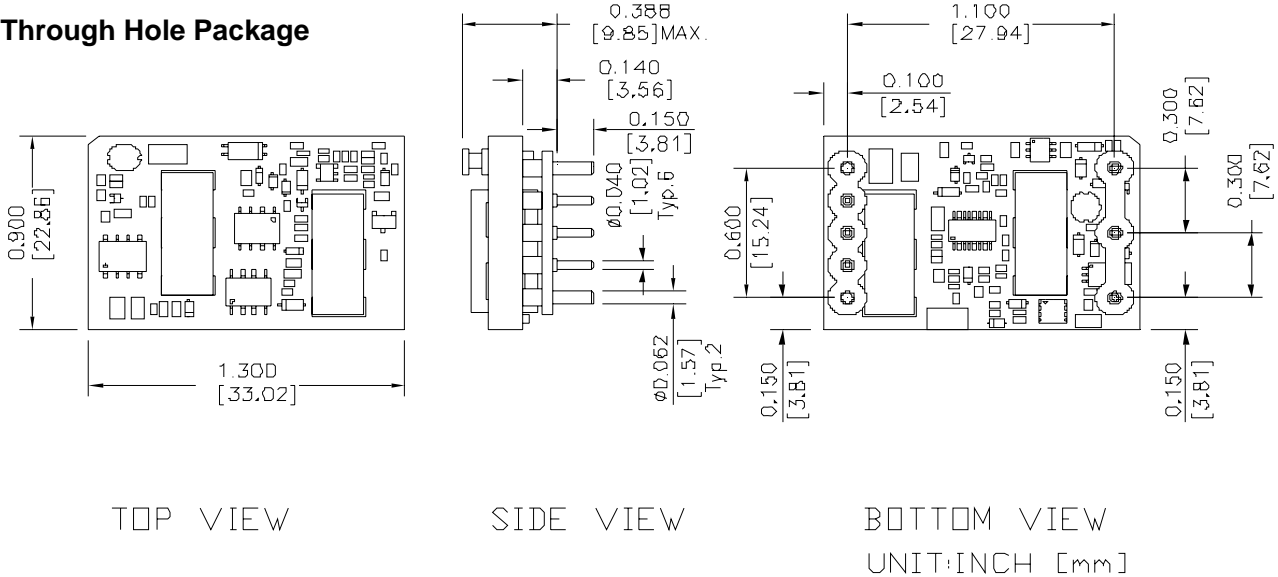

Pin Connections

Pin	Function
1	Vin (+)
2	Remote On/Off
3	Vin (-)
4	Vout-
5	Remote Sense (-)
6	Trim
7	Remote Sense (+)
8	Vout (+)

HOLE SIZE: 1-3, 5-7 $\phi 0.047$ [1.19],
 4,8 $\phi 0.07$ [1.78]
 PAD SIZE: 1-3, 5-7 $\phi 0.08$ [2.03]
 4,8 $\phi 0.10$ [2.54]

Note:

- 1) All Pins: Material - Copper Alloy;
 Finish – 3 micro inches minimum Gold over 50 micro inches minimum Nickel plate.
- 2) Undimensioned components are shown for visual reference only.
- 3) All dimensions in inches; Tolerances: x.xx +/-0.02 in. x.xxx +/-0.010 in. unless otherwise stated.

ISOLATED DC/DC CONVERTERS

48 Vdc Input, 1.2 Vdc - 12 Vdc / 15 A - 3 A Outputs, 1/16 Brick Converter



Apr. 09, 2010

Bel Power Inc., a subsidiary of Bel Fuse Inc.

Revision History

Date	Revision	Changes Detail	Approval
2010-4-9	B	Update the 0RSB-30T series product height from 0.378" to 0.388".	Jack Fan

RoHS Compliance

Complies with the European Directive 2002/95/EC, calling for the elimination of lead and other hazardous substances from electronic products.



©2010 Bel Fuse Inc. Specifications subject to change without notice. 040910

CORPORATE

Bel Fuse Inc.
206 Van Vorst Street
Jersey City, NJ 07302
Tel 201-432-0463
Fax 201-432-9542
www.belfuse.com

FAR EAST

Bel Fuse Ltd.
8F/ 8 Luk Hop Street
San Po Kong
Kowloon, Hong Kong
Tel 852-2328-5515
Fax 852-2352-3706
www.belfuse.com

EUROPE

Bel Fuse Europe Ltd.
Preston Technology Management Centre
Marsh Lane, Suite G7, Preston
Lancashire, PR1 8UD, U.K.
Tel 44-1772-556601
Fax 44-1772-888366
www.belfuse.com



Компания «ЭлектроПласт» предлагает заключение долгосрочных отношений при поставках импортных электронных компонентов на взаимовыгодных условиях!

Наши преимущества:

- Оперативные поставки широкого спектра электронных компонентов отечественного и импортного производства напрямую от производителей и с крупнейших мировых складов;
- Поставка более 17-ти миллионов наименований электронных компонентов;
- Поставка сложных, дефицитных, либо снятых с производства позиций;
- Оперативные сроки поставки под заказ (от 5 рабочих дней);
- Экспресс доставка в любую точку России;
- Техническая поддержка проекта, помощь в подборе аналогов, поставка прототипов;
- Система менеджмента качества сертифицирована по Международному стандарту ISO 9001;
- Лицензия ФСБ на осуществление работ с использованием сведений, составляющих государственную тайну;
- Поставка специализированных компонентов (Xilinx, Altera, Analog Devices, Intersil, Interpoint, Microsemi, Aeroflex, Peregrine, Syfer, Eurofarad, Texas Instrument, Miteq, Cobham, E2V, MA-COM, Hittite, Mini-Circuits, General Dynamics и др.);

Помимо этого, одним из направлений компании «ЭлектроПласт» является направление «Источники питания». Мы предлагаем Вам помощь Конструкторского отдела:

- Подбор оптимального решения, техническое обоснование при выборе компонента;
- Подбор аналогов;
- Консультации по применению компонента;
- Поставка образцов и прототипов;
- Техническая поддержка проекта;
- Защита от снятия компонента с производства.



Как с нами связаться

Телефон: 8 (812) 309 58 32 (многоканальный)

Факс: 8 (812) 320-02-42

Электронная почта: org@eplast1.ru

Адрес: 198099, г. Санкт-Петербург, ул. Калинина, дом 2, корпус 4, литера А.