

HEXFET® Power MOSFET

**Features**

- Advanced Process Technology
- Ultra Low On-Resistance
- 175°C Operating Temperature
- Fast Switching
- Repetitive Avalanche Allowed up to Tjmax
- Lead-Free, RoHS Compliant
- Automotive Qualified \*

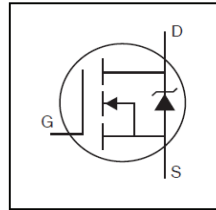

$V_{DSS}$	<b>60V</b>
$R_{DS(on)}$ <b>typ.</b>	<b>7.1mΩ</b>
	<b>8.4mΩ</b>
<b>max.</b>	
$I_D$	<b>79A</b>

**Description**

Specifically designed for Automotive applications, this HEXFET® Power MOSFET utilizes the latest processing techniques to achieve extremely low on-resistance per silicon area. Additional features of this design are a 175°C junction operating temperature, fast switching speed and improved repetitive avalanche rating. These features combine to make this design an extremely efficient and reliable device for use in Automotive applications and a wide variety of other applications.

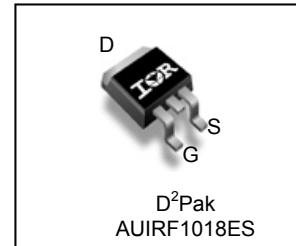

<b>G</b>	<b>D</b>	<b>S</b>
Gate	Drain	Source

Base part number	Package Type	Standard Pack		Orderable Part Number
		Form	Quantity	
AUIRF1018ES	D²-Pak	Tube	50	AUIRF1018ES
		Tape and Reel Left	800	AUIRF1018ESTRL

**Absolute Maximum Ratings**

Stresses beyond those listed under “Absolute Maximum Ratings” may cause permanent damage to the device. These are stress ratings only; and functional operation of the device at these or any other condition beyond those indicated in the specifications is not implied. Exposure to absolute-maximum-rated conditions for extended periods may affect device reliability. The thermal resistance and power dissipation ratings are measured under board mounted and still air conditions. Ambient temperature (TA) is 25°C, unless

Symbol	Parameter	Max.	Units
$I_D @ T_C = 25^\circ C$	Continuous Drain Current, $V_{GS} @ 10V$	79	A
$I_D @ T_C = 100^\circ C$	Continuous Drain Current, $V_{GS} @ 10V$	56	
$I_{DM}$	Pulsed Drain Current ①	315	
$P_D @ T_C = 25^\circ C$	Maximum Power Dissipation	110	W
	Linear Derating Factor	0.76	W/°C
$V_{GS}$	Gate-to-Source Voltage	± 20	V
$E_{AS}$	Single Pulse Avalanche Energy (Thermally Limited) ②	88	mJ
$I_{AR}$	Avalanche Current ①	47	A
$E_{AR}$	Repetitive Avalanche Energy ①	11	mJ
dv/dt	Peak Diode Recovery ③	21	V/ns
$T_J$	Operating Junction and Storage Temperature Range	-55 to + 175	°C
$T_{STG}$			
	Soldering Temperature, for 10 seconds (1.6mm from case)	300	

**Thermal Resistance**

Symbol	Parameter	Typ.	Max.	Units
$R_{\theta JC}$	Junction-to-Case ④	—	1.32	°C/W
$R_{\theta JA}$	Junction-to-Ambient (PCB Mount), D² Pak ⑦	—	40	

HEXFET® is a registered trademark of Infineon.

\*Qualification standards can be found at [www.infineon.com](http://www.infineon.com)

**Static @ T<sub>J</sub> = 25°C (unless otherwise specified)**

	Parameter	Min.	Typ.	Max.	Units	Conditions
V <sub>(BR)DSS</sub>	Drain-to-Source Breakdown Voltage	60	—	—	V	V <sub>GS</sub> = 0V, I <sub>D</sub> = 250μA
ΔV <sub>(BR)DSS</sub> /ΔT <sub>J</sub>	Breakdown Voltage Temp. Coefficient	—	0.073	—	V/°C	Reference to 25°C, I <sub>D</sub> = 5mA ①
R <sub>DS(on)</sub>	Static Drain-to-Source On-Resistance	—	7.1	8.4	mΩ	V <sub>GS</sub> = 10V, I <sub>D</sub> = 47A ④
V <sub>GS(th)</sub>	Gate Threshold Voltage	2.0	—	4.0	V	V <sub>DS</sub> = V <sub>GS</sub> , I <sub>D</sub> = 100μA
g <sub>fs</sub>	Forward Trans conductance	110	—	—	S	V <sub>DS</sub> = 50V, I <sub>D</sub> = 47A
R <sub>G</sub>	Internal Gate Resistance	—	0.73	—	Ω	
I <sub>DSS</sub>	Drain-to-Source Leakage Current	—	—	20	μA	V <sub>DS</sub> = 60V, V <sub>GS</sub> = 0V
		—	—	250		V <sub>DS</sub> = 48V, V <sub>GS</sub> = 0V, T <sub>J</sub> = 125°C
I <sub>GSS</sub>	Gate-to-Source Forward Leakage	—	—	100	nA	V <sub>GS</sub> = 20V
	Gate-to-Source Reverse Leakage	—	—	-100		V <sub>GS</sub> = -20V

**Dynamic Electrical Characteristics @ T<sub>J</sub> = 25°C (unless otherwise specified)**

Q <sub>g</sub>	Total Gate Charge	—	46	69	nC	I <sub>D</sub> = 47A V <sub>DS</sub> = 30V V <sub>GS</sub> = 10V④
Q <sub>gs</sub>	Gate-to-Source Charge	—	10	—		
Q <sub>gd</sub>	Gate-to-Drain Charge	—	12	—		
Q <sub>sync</sub>	Total Gate Charge Sync. (Q <sub>g</sub> - Q <sub>gd</sub> )	—	34	—		
t <sub>d(on)</sub>	Turn-On Delay Time	—	13	—	ns	V <sub>DD</sub> = 39V I <sub>D</sub> = 47A R <sub>G</sub> = 10Ω V <sub>GS</sub> = 10V④
t <sub>r</sub>	Rise Time	—	35	—		
t <sub>d(off)</sub>	Turn-Off Delay Time	—	55	—		
t <sub>f</sub>	Fall Time	—	46	—		
C <sub>iss</sub>	Input Capacitance	—	2290	—	pF	V <sub>GS</sub> = 0V V <sub>DS</sub> = 50V f = 1.0MHz
C <sub>oss</sub>	Output Capacitance	—	270	—		
C <sub>rss</sub>	Reverse Transfer Capacitance	—	130	—		
C <sub>oss eff.(ER)</sub>	Effective Output Capacitance (Energy Related)	—	390	—		
C <sub>oss eff.(TR)</sub>	Effective Output Capacitance (Time Related)	—	630	—		

**Diode Characteristics**

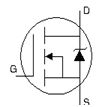
	Parameter	Min.	Typ.	Max.	Units	Conditions
I <sub>S</sub>	Continuous Source Current (Body Diode)	—	—	79	A	MOSFET symbol showing the integral reverse p-n junction diode. 
I <sub>SM</sub>	Pulsed Source Current (Body Diode) ①	—	—	315		
V <sub>SD</sub>	Diode Forward Voltage	—	—	1.3	V	T <sub>J</sub> = 25°C, I <sub>S</sub> = 47A, V <sub>GS</sub> = 0V ④
t <sub>rr</sub>	Reverse Recovery Time	—	26	39	ns	T <sub>J</sub> = 25°C V <sub>DD</sub> = 51V
		—	31	47		T <sub>J</sub> = 125°C I <sub>F</sub> = 47A,
Q <sub>rr</sub>	Reverse Recovery Charge	—	24	36	nC	T <sub>J</sub> = 25°C di/dt = 100A/μs ④
		—	35	53		T <sub>J</sub> = 125°C
I <sub>RRM</sub>	Reverse Recovery Current	—	1.8	—	A	T <sub>J</sub> = 25°C
t <sub>on</sub>	Forward Turn-On Time	Intrinsic turn-on time is negligible (turn-on is dominated by L <sub>S</sub> +L <sub>D</sub> )				

**Notes:**

- ① Repetitive rating; pulse width limited by max. junction temperature.
- ② Limited by T<sub>Jmax</sub>, starting T<sub>J</sub> = 25°C, L = 0.08mH, R<sub>G</sub> = 25Ω, I<sub>AS</sub> = 47A, V<sub>GS</sub> = 10V. Part not recommended for use above this value.
- ③ I<sub>SD</sub> ≤ 47A, di/dt ≤ 1668A/μs, V<sub>DD</sub> ≤ V<sub>(BR)DSS</sub>, T<sub>J</sub> ≤ 175°C.
- ④ Pulse width ≤ 400μs; duty cycle ≤ 2%.
- ⑤ C<sub>oss eff. (TR)</sub> is a fixed capacitance that gives the same charging time as C<sub>oss</sub> while V<sub>DS</sub> is rising from 0 to 80% V<sub>DSS</sub>.
- ⑥ C<sub>oss eff. (ER)</sub> is a fixed capacitance that gives the same energy as C<sub>oss</sub> while V<sub>DS</sub> is rising from 0 to 80% V<sub>DSS</sub>.
- ⑦ When mounted on 1" square PCB (FR-4 or G-10 Material). For recommended footprint and soldering techniques refer to application note #AN-994
- ⑧ R<sub>θ</sub> is measured at T<sub>J</sub> approximately 90°C.
- ⑨ This is only applied to TO-220.

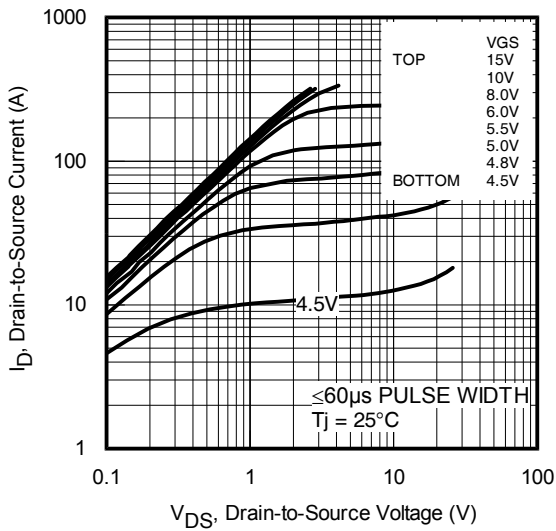
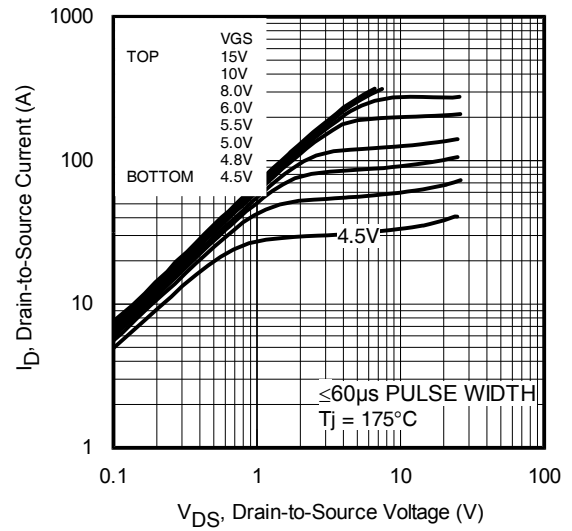
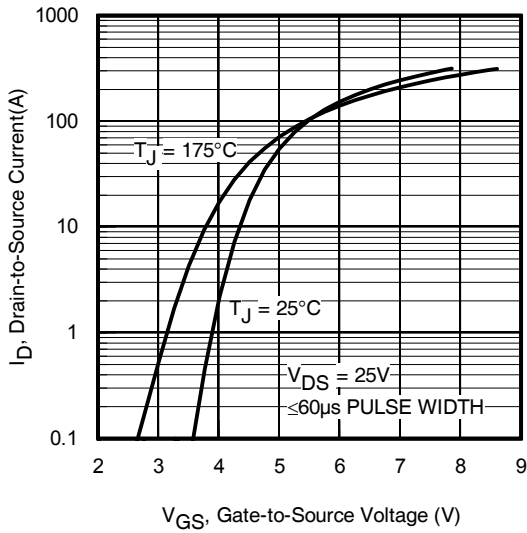
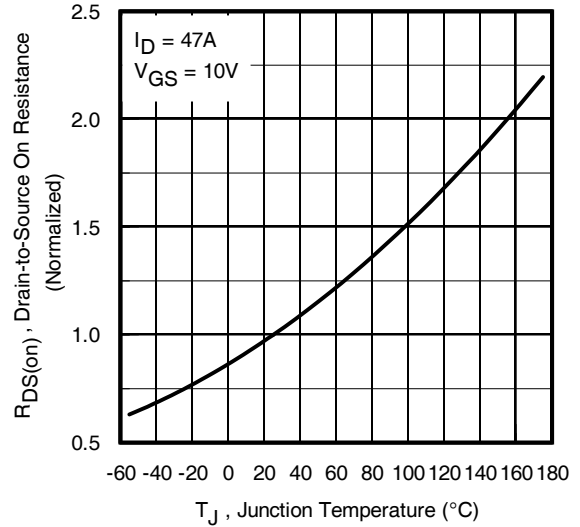
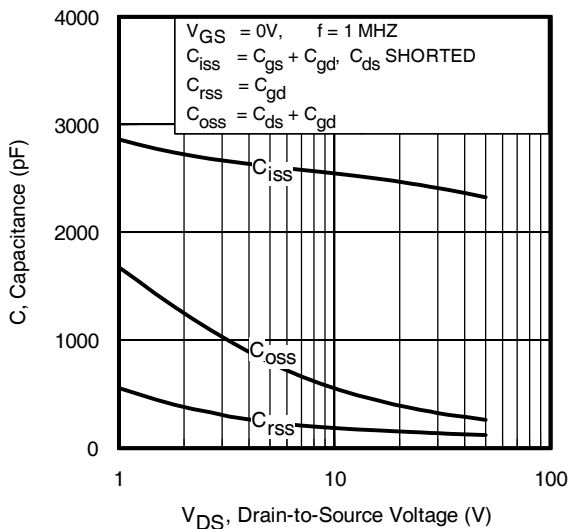
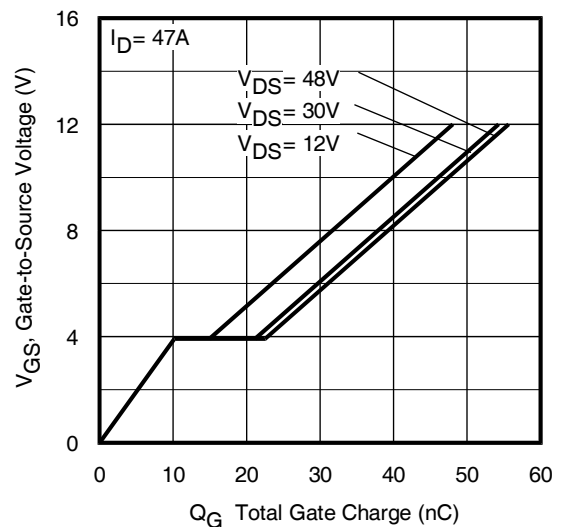
**Fig. 1** Typical Output Characteristics

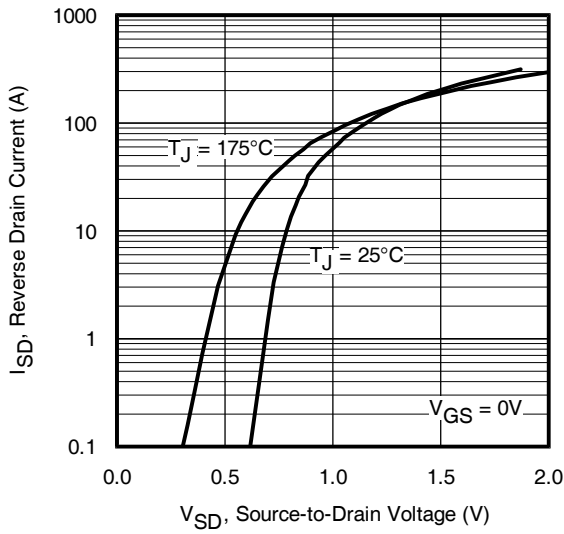
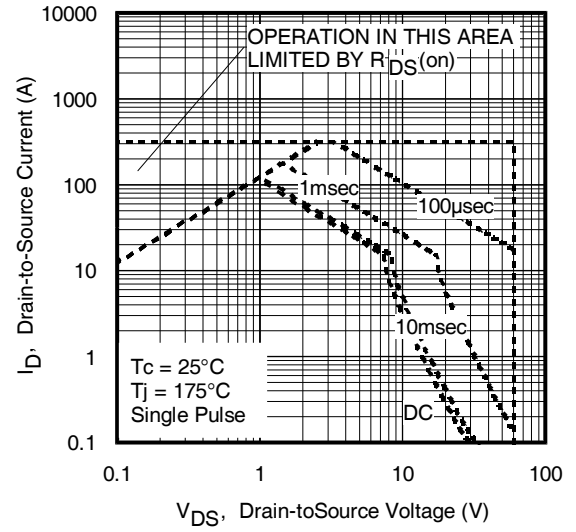
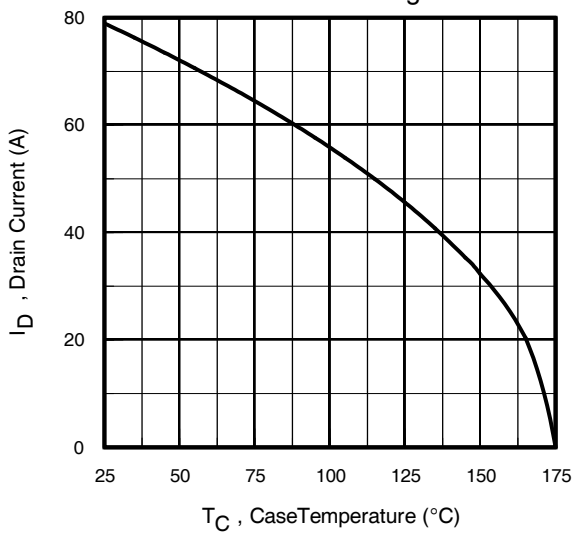
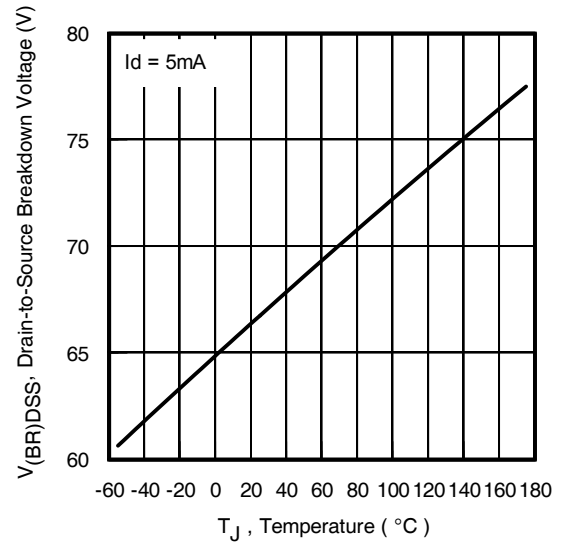
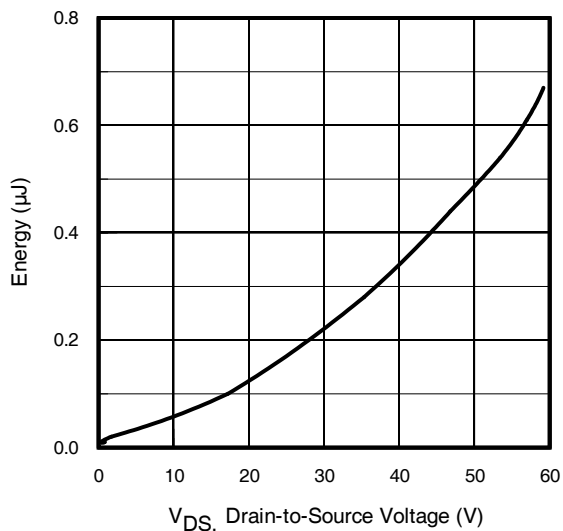
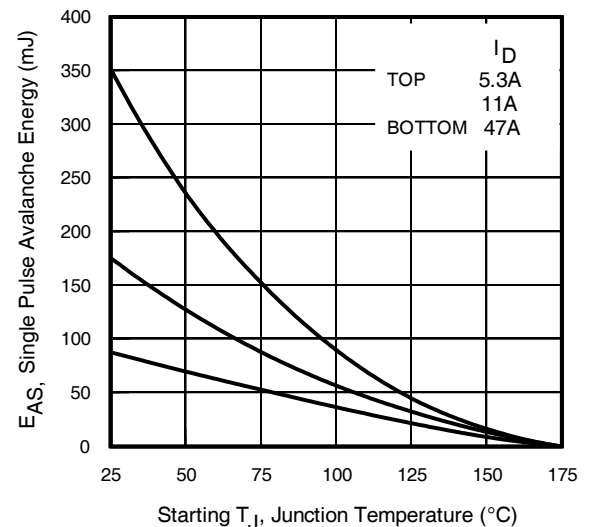
**Fig. 2** Typical Output Characteristics

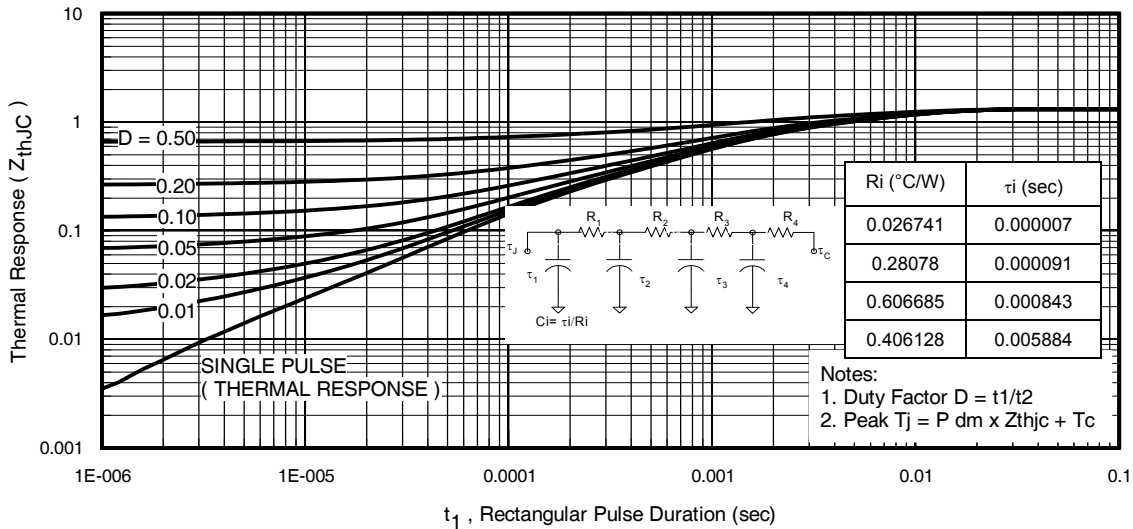
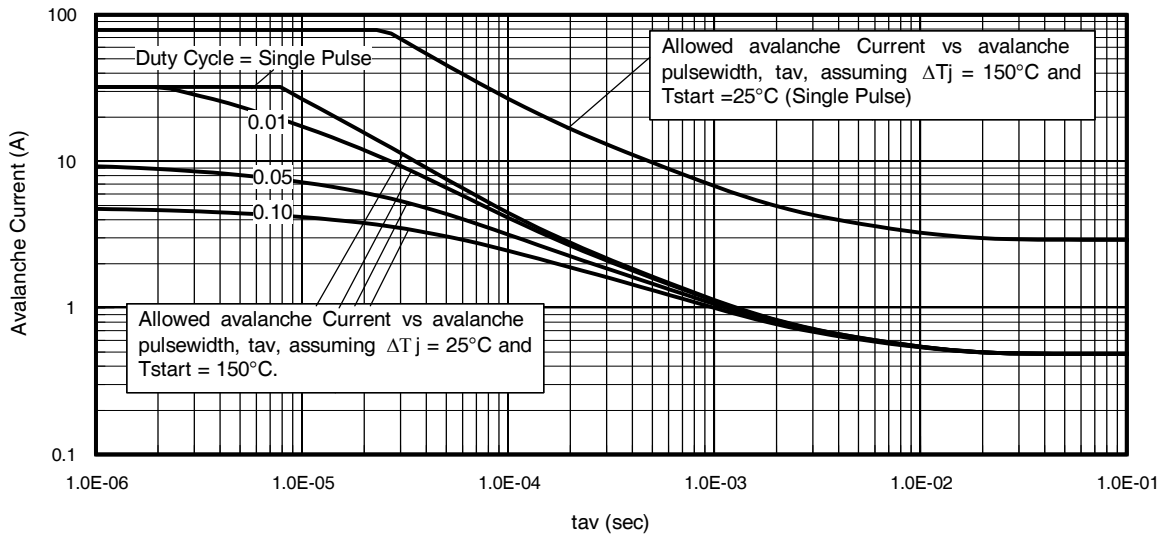
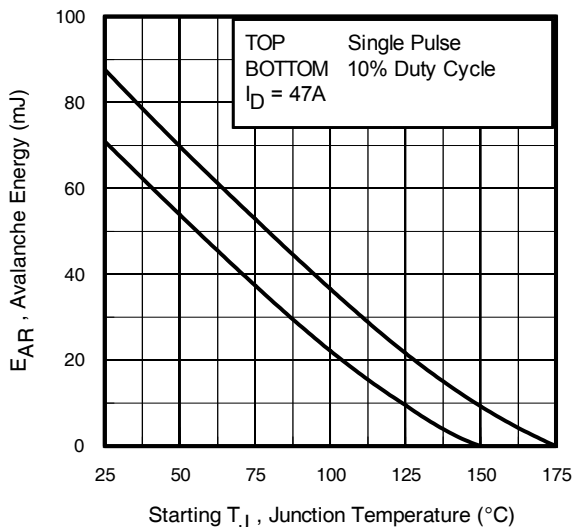
**Fig. 3** Typical Transfer Characteristics

**Fig. 4** Normalized On-Resistance vs. Temperature

**Fig. 5.** Typical Capacitance vs. Drain-to-Source Voltage

**Fig. 6.** Typical Gate Charge vs. Gate-to-Source Voltage

**Fig. 7** Typical Source-to-Drain Diode Forward Voltage

**Fig. 8.** Maximum Safe Operating Area

**Fig. 9.** Maximum Drain Current vs. Case Temperature

**Fig. 10.** Drain-to-Source Breakdown Voltage

**Fig. 11.** Typical Coss Stored Energy

**Fig. 12.** Maximum Avalanche Energy vs. Drain Current

**Fig 13. Maximum Effective Transient Thermal Impedance, Junction-to-Case**

**Fig 14. Avalanche Current vs. Pulse width**

**Notes on Repetitive Avalanche Curves , Figures 14, 15:  
 (For further info, see AN-1005 at www.infineon.com)**

1. Avalanche failures assumption:  
Purely a thermal phenomenon and failure occurs at a temperature far in excess of  $T_{jmax}$ . This is validated for every part type.
2. Safe operation in Avalanche is allowed as long as  $T_{jmax}$  is not exceeded.
3. Equation below based on circuit and waveforms shown in Figures 18a, 18b.
4.  $P_{D(ave)}$  = Average power dissipation per single avalanche pulse.
5.  $BV$  = Rated breakdown voltage (1.3 factor accounts for voltage increase during avalanche).
6.  $I_{av}$  = Allowable avalanche current.
7.  $\Delta T$  = Allowable rise in junction temperature, not to exceed  $T_{jmax}$  (assumed as 25°C in Figure 13, 14).  
 $t_{av}$  = Average time in avalanche.  
 $D$  = Duty cycle in avalanche =  $t_{av} \cdot f$   
 $Z_{thJC}(D, t_{av})$  = Transient thermal resistance, see Figures 13)

$$P_{D(ave)} = 1/2 ( 1.3 \cdot BV \cdot I_{av} ) = \Delta T / Z_{thJC}$$

$$I_{av} = 2\Delta T / [ 1.3 \cdot BV \cdot Z_{th} ]$$

$$E_{AS(AR)} = P_{D(ave)} \cdot t_{av}$$

**Fig 15. Maximum Avalanche Energy vs. Temperature**

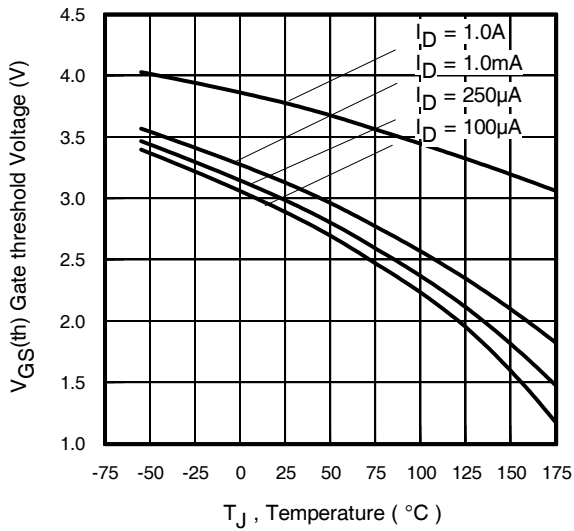
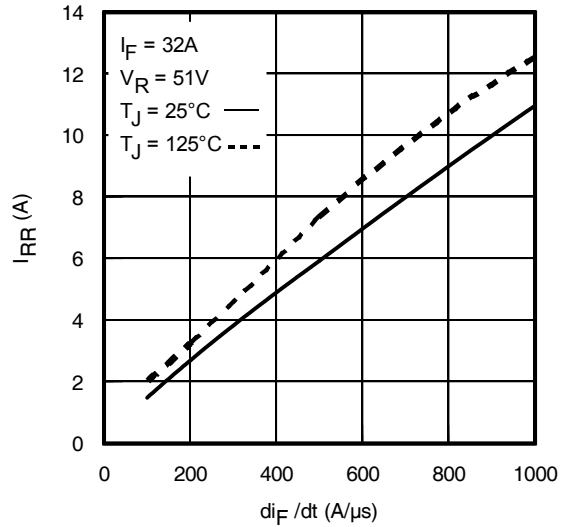
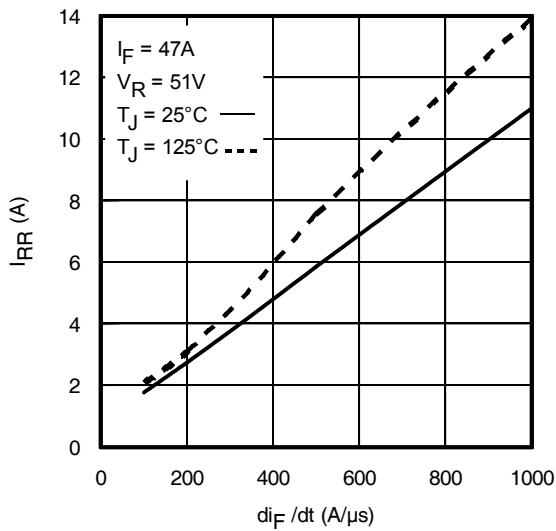
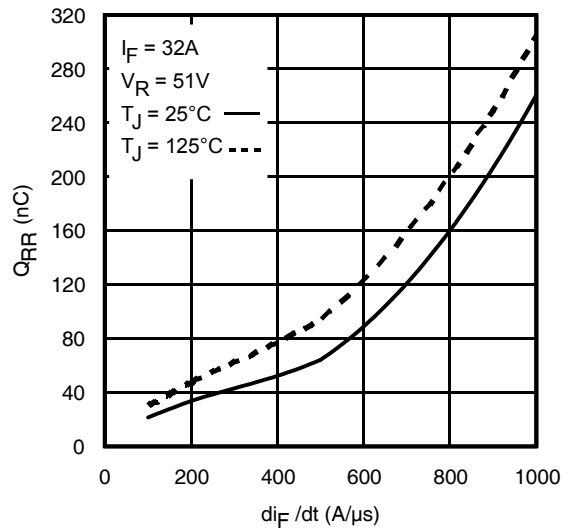
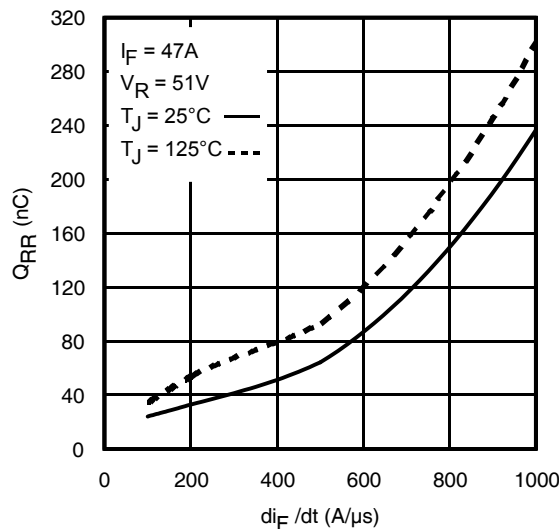
**Fig. 16.** Threshold Voltage vs. Temperature

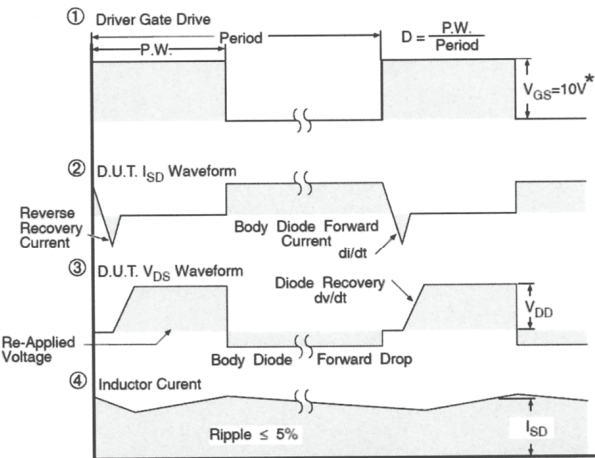
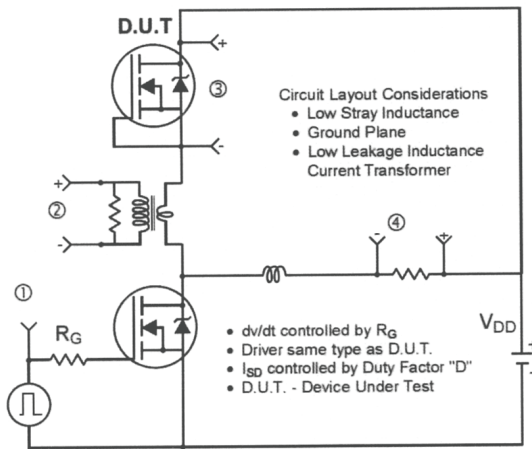
**Fig. 17 -** Typical Recovery Current vs.  $di/dt$ 

**Fig. 18 -** Typical Recovery Current vs.  $di/dt$ 

**Fig. 19 -** Typical Stored Charge vs.  $di/dt$ 

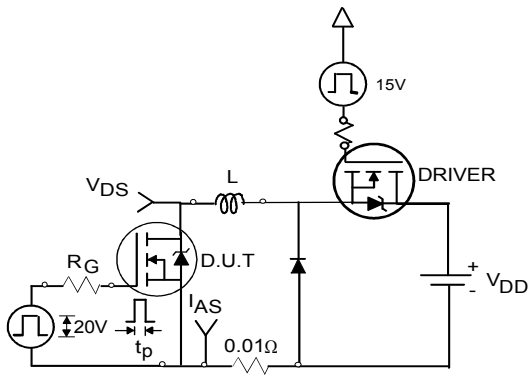
**Fig. 20 -** Typical Stored Charge vs.  $di/dt$



\*  $V_{GS} = 5V$  for Logic Level Devices

**Fig 21.** Peak Diode Recovery  $dv/dt$  Test Circuit for N-Channel HEXFET® Power MOSFETs



**Fig 22a.** Unclamped Inductive Test Circuit

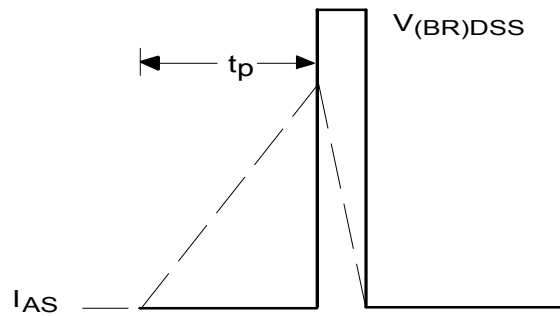

**Fig 22b.** Unclamped Inductive Waveforms

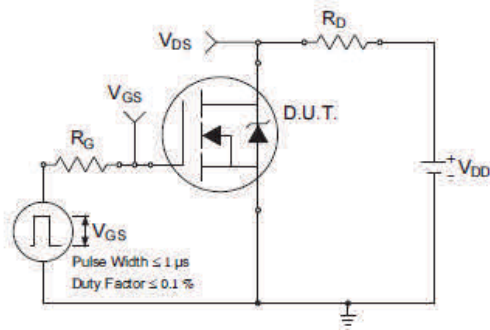

**Fig 23a.** Switching Time Test Circuit

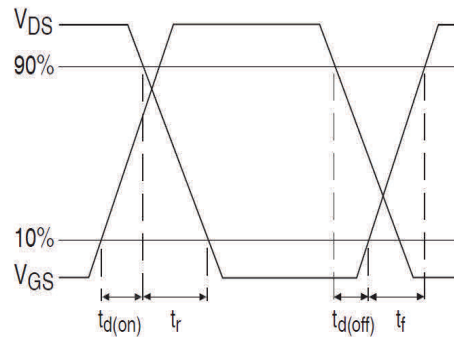

**Fig 23b.** Switching Time Waveforms

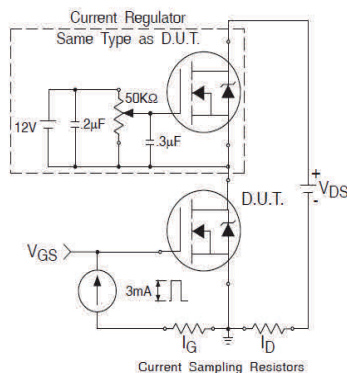

**Fig 24a.** Gate Charge Test Circuit

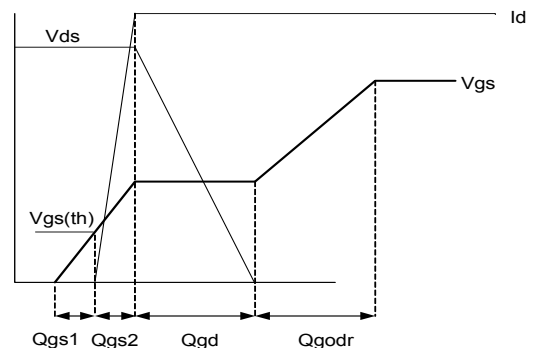

**Fig 24b.** Gate Charge Waveform

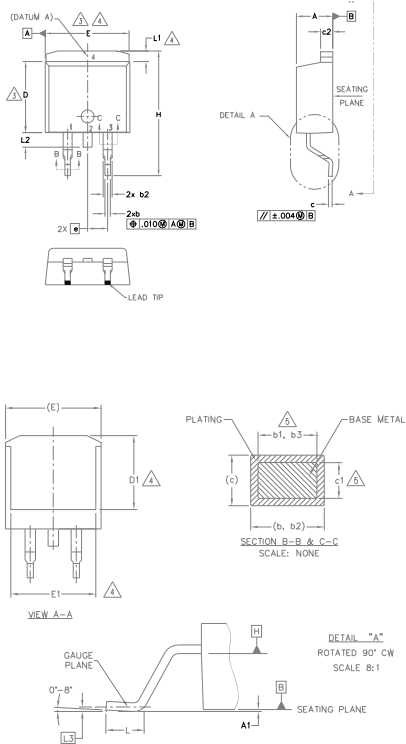
**D<sup>2</sup>Pak (TO-263AB) Package Outline (Dimensions are shown in millimeters (inches))**

- NOTES:
1. DIMENSIONING AND TOLERANCING PER ASME Y14.5M-1994
  2. DIMENSIONS ARE SHOWN IN MILLIMETERS [INCHES].
  3. DIMENSION D & E DO NOT INCLUDE MOLD FLASH. MOLD FLASH SHALL NOT EXCEED 0.127 [0.005"] PER SIDE. THESE DIMENSIONS ARE MEASURED AT THE OUTMOST EXTREMES OF THE PLASTIC BODY AT DATUM H.
  4. THERMAL PAD CONTOUR OPTIONAL WITHIN DIMENSION E, L1, D1 & E1.
  5. DIMENSION b1, b3 AND c1 APPLY TO BASE METAL ONLY.
  6. DATUM A & B TO BE DETERMINED AT DATUM PLANE H.
  7. CONTROLLING DIMENSION: INCH.
  8. OUTLINE CONFORMS TO JEDEC OUTLINE TO-263AB.

SYMBOL	DIMENSIONS				NOTES
	MILLIMETERS		INCHES		
	MIN.	MAX.	MIN.	MAX.	
A	4.06	4.83	.160	.190	
A1	0.00	0.254	.000	.010	
b	0.51	0.99	.020	.039	
b1	0.51	0.89	.020	.035	5
b2	1.14	1.78	.045	.070	
b3	1.14	1.73	.045	.068	5
c	0.38	0.74	.015	.029	
c1	0.38	0.58	.015	.023	5
c2	1.14	1.65	.045	.065	
D	8.38	9.65	.330	.380	3
D1	6.86	—	.270	—	4
E	9.65	10.67	.380	.420	3,4
E1	6.22	—	.245	—	4
e	2.54 BSC		.100 BSC		
H	14.61	15.88	.575	.625	
L	1.78	2.79	.070	.110	
L1	—	1.68	—	.066	4
L2	—	1.78	—	.070	
L3	0.25 BSC		.010 BSC		

**LEAD ASSIGNMENTS**
**DIODES**

- 1.- ANODE (TWO DIE) / OPEN (ONE DIE)
- 2.- CATHODE
- 3.- ANODE

**HEXFET**

- 1.- GATE
- 2, 4.- DRAIN
- 3.- SOURCE

**IGBTs, CoPACK**

- 1.- GATE
- 2, 4.- COLLECTOR
- 3.- EMITTER

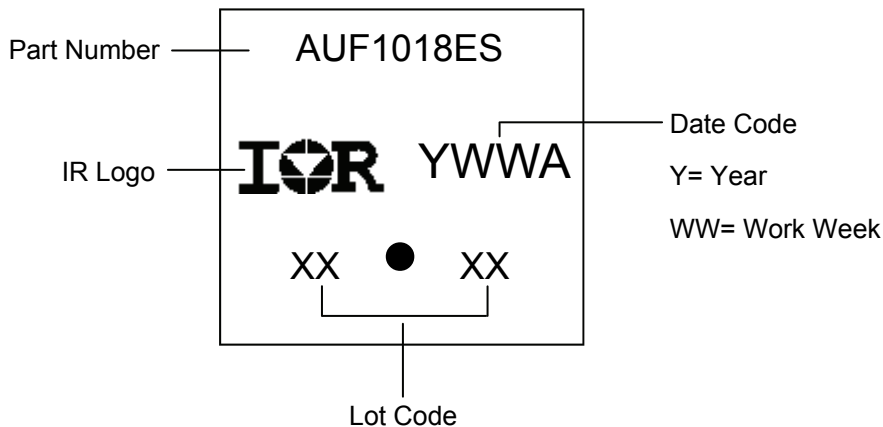
**D<sup>2</sup>Pak (TO-263AB) Part Marking Information**

Note: For the most current drawing please refer to IR website at <http://www.irf.com/package/>

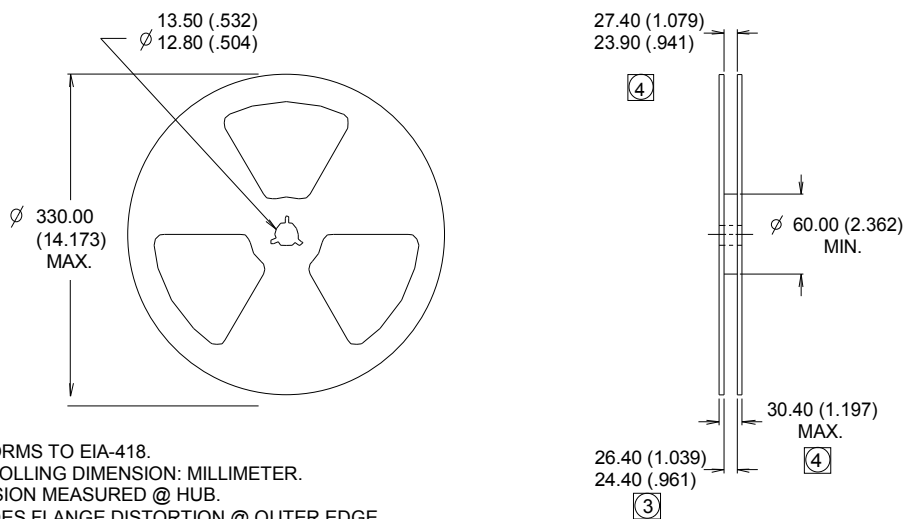
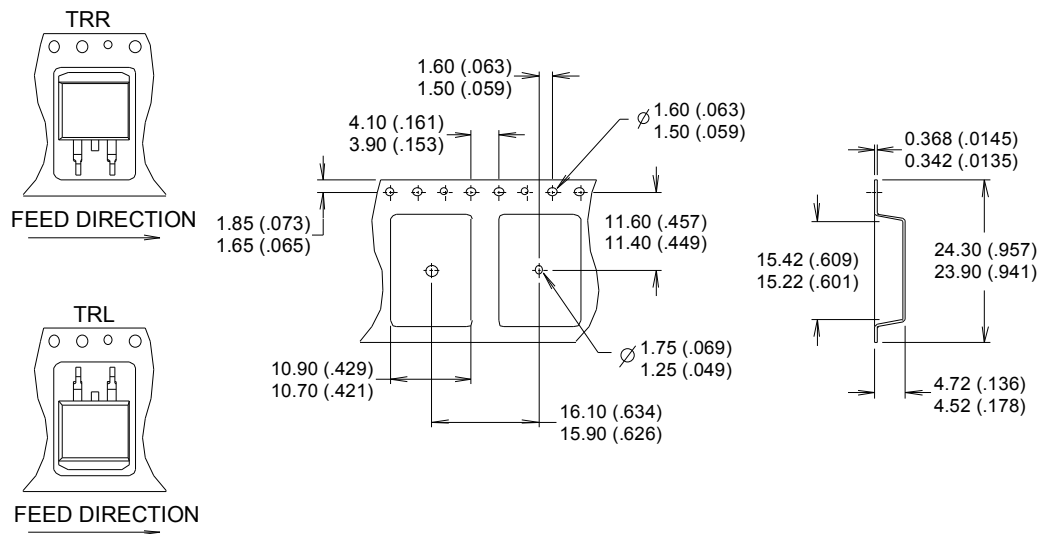

**D<sup>2</sup>Pak (TO-263AB) Tape & Reel Information (Dimensions are shown in millimeters (inches))**

- NOTES :
1. COMFORMS TO EIA-418.
  2. CONTROLLING DIMENSION: MILLIMETER.
  - ③ DIMENSION MEASURED @ HUB.
  - ④ INCLUDES FLANGE DISTORTION @ OUTER EDGE.

Note: For the most current drawing please refer to IR website at <http://www.irf.com/package/>

**Qualification Information**

<b>Qualification Level</b>		Automotive (per AEC-Q101)	
		Comments: This part number(s) passed Automotive qualification. Infineon's Industrial and Consumer qualification level is granted by extension of the higher Automotive level.	
<b>Moisture Sensitivity Level</b>		D <sup>2</sup> -Pak	MSL1
<b>ESD</b>	Human Body Model	Class H1B (+/- 1000V) <sup>†</sup> AEC-Q101-001	
	Charged Device Model	Class C5 (+/- 1000V) <sup>†</sup> AEC-Q101-005	
<b>RoHS Compliant</b>		Yes	

**Revision History**

Date	Comments
11/23/2015	<ul style="list-style-type: none"> <li>• Updated datasheet with corporate template</li> <li>• Corrected ordering table on page 1.</li> <li>• Added ESD table on page10</li> </ul>

**Published by**  
**Infineon Technologies AG**  
**81726 München, Germany**  
 © Infineon Technologies AG 2015  
**All Rights Reserved.**

**IMPORTANT NOTICE**

The information given in this document shall in no event be regarded as a guarantee of conditions or characteristics ("Beschaffenhheitsgarantie"). With respect to any examples, hints or any typical values stated herein and/or any information regarding the application of the product, Infineon Technologies hereby disclaims any and all warranties and liabilities of any kind, including without limitation warranties of non-infringement of intellectual property rights of any third party.

In addition, any information given in this document is subject to customer's compliance with its obligations stated in this document and any applicable legal requirements, norms and standards concerning customer's products and any use of the product of Infineon Technologies in customer's applications.

The data contained in this document is exclusively intended for technically trained staff. It is the responsibility of customer's technical departments to evaluate the suitability of the product for the intended application and the completeness of the product information given in this document with respect to such application.

For further information on the product, technology, delivery terms and conditions and prices please contact your nearest Infineon Technologies office ([www.infineon.com](http://www.infineon.com)).

**WARNINGS**

Due to technical requirements products may contain dangerous substances. For information on the types in question please contact your nearest Infineon Technologies office.

Except as otherwise explicitly approved by Infineon Technologies in a written document signed by authorized representatives of Infineon Technologies, Infineon Technologies' products may not be used in any applications where a failure of the product or any consequences of the use thereof can reasonably be expected to result in personal injury.



Компания «ЭлектроПласт» предлагает заключение долгосрочных отношений при поставках импортных электронных компонентов на взаимовыгодных условиях!

Наши преимущества:

- Оперативные поставки широкого спектра электронных компонентов отечественного и импортного производства напрямую от производителей и с крупнейших мировых складов;
- Поставка более 17-ти миллионов наименований электронных компонентов;
- Поставка сложных, дефицитных, либо снятых с производства позиций;
- Оперативные сроки поставки под заказ (от 5 рабочих дней);
- Экспресс доставка в любую точку России;
- Техническая поддержка проекта, помощь в подборе аналогов, поставка прототипов;
- Система менеджмента качества сертифицирована по Международному стандарту ISO 9001;
- Лицензия ФСБ на осуществление работ с использованием сведений, составляющих государственную тайну;
- Поставка специализированных компонентов (Xilinx, Altera, Analog Devices, Intersil, Interpoint, Microsemi, Aeroflex, Peregrine, Syfer, Eurofarad, Texas Instrument, Miteq, Cobham, E2V, MA-COM, Hittite, Mini-Circuits, General Dynamics и др.);

Помимо этого, одним из направлений компании «ЭлектроПласт» является направление «Источники питания». Мы предлагаем Вам помощь Конструкторского отдела:

- Подбор оптимального решения, техническое обоснование при выборе компонента;
- Подбор аналогов;
- Консультации по применению компонента;
- Поставка образцов и прототипов;
- Техническая поддержка проекта;
- Защита от снятия компонента с производства.



#### Как с нами связаться

**Телефон:** 8 (812) 309 58 32 (многоканальный)

**Факс:** 8 (812) 320-02-42

**Электронная почта:** [org@eplast1.ru](mailto:org@eplast1.ru)

**Адрес:** 198099, г. Санкт-Петербург, ул. Калинина, дом 2, корпус 4, литера А.