

74LVC1G125

Bus buffer/line driver; 3-state

Rev. 13 — 6 November 2017

Product data sheet

1 General description

The 74LVC1G125 provides one non-inverting buffer/line driver with 3-state output. The 3-state output is controlled by the output enable input (\overline{OE}). A HIGH-level at pin \overline{OE} causes the output to assume a high-impedance OFF-state.

The input can be driven from either 3.3 V or 5 V devices. This feature allows the use of this device in a mixed 3.3 V and 5 V environment.

This device is fully specified for partial power-down applications using I_{OFF} . The I_{OFF} circuitry disables the output, preventing the damaging backflow current through the device when it is powered down.

2 Features and benefits

- Wide supply voltage range from 1.65 V to 5.5 V
- High noise immunity
- Complies with JEDEC standard:
 - JESD8-7 (1.65 V to 1.95 V)
 - JESD8-5 (2.3 V to 2.7 V)
 - JESD8-B/JESD36 (2.7 V to 3.6 V)
- ± 24 mA output drive ($V_{CC} = 3.0$ V)
- ESD protection:
 - HBM JESD22-A114F exceeds 2 000 V
 - MM JESD22-A115-A exceeds 200 V
- CMOS low power consumption
- Inputs accept voltages up to 5 V
- Latch-up performance exceeds 250 mA
- Direct interface with TTL levels
- Multiple package options
- Specified from -40 °C to $+85$ °C and -40 °C to $+125$ °C

3 Ordering information

Table 1. Ordering information

| Type number | Package | | | Version |
|--------------|-------------------|--------|--|----------|
| | Temperature range | Name | Description | |
| 74LVC1G125GW | -40 °C to +125 °C | TSSOP5 | plastic thin shrink small outline package; 5 leads; body width 1.25 mm | SOT353-1 |
| 74LVC1G125GV | -40 °C to +125 °C | SC-74A | plastic surface-mounted package; 5 leads | SOT753 |
| 74LVC1G125GM | -40 °C to +125 °C | XSON6 | plastic extremely thin small outline package; no leads; 6 terminals; body 1 x 1.45 x 0.5 mm | SOT886 |
| 74LVC1G125GF | -40 °C to +125 °C | XSON6 | plastic extremely thin small outline package; no leads; 6 terminals; body 1 x 1 x 0.5 mm | SOT891 |
| 74LVC1G125GN | -40 °C to +125 °C | XSON6 | extremely thin small outline package; no leads; 6 terminals; body 0.9 x 1.0 x 0.35 mm | SOT1115 |
| 74LVC1G125GS | -40 °C to +125 °C | XSON6 | extremely thin small outline package; no leads; 6 terminals; body 1.0 x 1.0 x 0.35 mm | SOT1202 |
| 74LVC1G125GX | -40 °C to +125 °C | X2SON5 | X2SON5: plastic thermal enhanced extremely thin small outline package; no leads; 5 terminals; body 0.8 x 0.8 x 0.35 mm | SOT1226 |

4 Marking

Table 2. Marking

| Type number | Marking code ^[1] |
|--------------|-----------------------------|
| 74LVC1G125GW | VM |
| 74LVC1G125GV | V25 |
| 74LVC1G125GM | VM |
| 74LVC1G125GF | VM |
| 74LVC1G125GN | VM |
| 74LVC1G125GS | VM |
| 74LVC1G125GX | VM |

[1] The pin 1 indicator is located on the lower left corner of the device, below the marking code.

5 Functional diagram

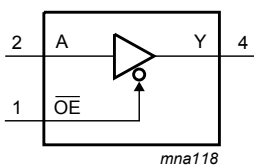

Figure 1. Logic symbol

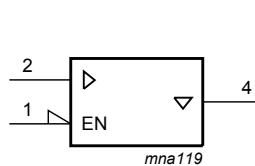

Figure 2. IEC logic symbol

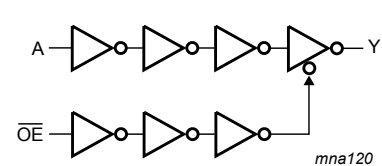

Figure 3. Logic diagram

6 Pinning information

6.1 Pinning

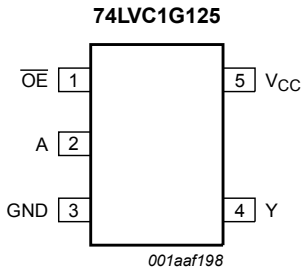

Figure 4. Pin configuration SOT353-1 and SOT753

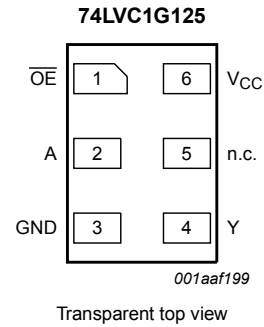

Figure 5. Pin configuration SOT886

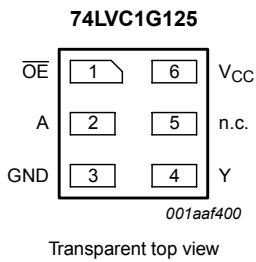

Figure 6. Pin configuration SOT891, SOT1115 and SOT1202

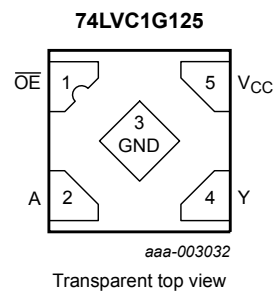

Figure 7. Pin configuration SOT1226 (X2SON5)

6.2 Pin description

Table 3. Pin description

| Symbol | Pin | | Description |
|------------------------|---------------------------|-------|---------------------|
| | TSSOP5, SC-74A and X2SON5 | XSON6 | |
| $\overline{\text{OE}}$ | 1 | 1 | output enable input |
| A | 2 | 2 | data input |
| GND | 3 | 3 | ground (0 V) |
| Y | 4 | 4 | data output |
| n.c. | - | 5 | not connected |
| V _{CC} | 5 | 6 | supply voltage |

7 Functional description

Table 4. Function table

H = HIGH voltage level; L = LOW voltage level; X = don't care; Z = high-impedance OFF-state.

| Input | | Output |
|-------|---|--------|
| OE | A | Y |
| L | L | L |
| L | H | H |
| H | X | Z |

8 Limiting values

Table 5. Limiting values

In accordance with the Absolute Maximum Rating System (IEC 60134). Voltages are referenced to GND (ground = 0 V).

| Symbol | Parameter | Conditions | Min | Max | Unit |
|-----------|-------------------------|---------------------------------|--------------|----------------|------|
| V_{CC} | supply voltage | | -0.5 | +6.5 | V |
| I_{IK} | input clamping current | $V_I < 0$ V | -50 | - | mA |
| V_I | input voltage | | [1] -0.5 | +6.5 | V |
| I_{OK} | output clamping current | $V_O > V_{CC}$ or $V_O < 0$ V | - | ± 50 | mA |
| V_O | output voltage | Active mode | [1] [2] -0.5 | $V_{CC} + 0.5$ | V |
| | | Power-down mode | [1] [2] -0.5 | +6.5 | V |
| I_O | output current | $V_O = 0$ V to V_{CC} | - | ± 50 | mA |
| I_{CC} | supply current | | - | 100 | mA |
| I_{GND} | ground current | | -100 | - | mA |
| P_{tot} | total power dissipation | $T_{amb} = -40$ °C to $+125$ °C | [3] - | 250 | mW |
| T_{stg} | storage temperature | | -65 | +150 | °C |

[1] The input and output voltage ratings may be exceeded if the input and output current ratings are observed.

[2] When $V_{CC} = 0$ V (Power-down mode), the output voltage can be 5.5 V in normal operation.

[3] For TSSOP5 and SC-74A packages: above 87.5 °C the value of P_{tot} derates linearly with 4.0 mW/K.

For XSON6 and X2SON5 package: above 118 °C the value of P_{tot} derates linearly with 7.8 mW/K.

9 Recommended operating conditions

Table 6. Recommended operating conditions

| Symbol | Parameter | Conditions | Min | Typ | Max | Unit |
|-----------|---------------------|---------------------------------|------|-----|----------|------|
| V_{CC} | supply voltage | | 1.65 | - | 5.5 | V |
| V_I | input voltage | | 0 | - | 5.5 | V |
| V_O | output voltage | Active mode | 0 | - | V_{CC} | V |
| | | $V_{CC} = 0$ V; Power-down mode | 0 | - | 5.5 | V |
| T_{amb} | ambient temperature | | -40 | - | +125 | °C |

| Symbol | Parameter | Conditions | Min | Typ | Max | Unit |
|---------------------|-------------------------------------|---|-----|-----|-----|------|
| $\Delta t/\Delta V$ | input transition rise and fall rate | $V_{CC} = 1.65 \text{ V to } 2.7 \text{ V}$ | - | - | 20 | ns/V |
| | | $V_{CC} = 2.7 \text{ V to } 5.5 \text{ V}$ | - | - | 10 | ns/V |

10 Static characteristics

Table 7. Static characteristics

At recommended operating conditions; voltages are referenced to GND (ground = 0 V).

| Symbol | Parameter | Conditions | Min | Typ ^[1] | Max | Unit |
|---|---------------------------|--|----------------------|--------------------|----------------------|---------------|
| $T_{amb} = -40 \text{ }^\circ\text{C to } +85 \text{ }^\circ\text{C}$ | | | | | | |
| V_{IH} | HIGH-level input voltage | $V_{CC} = 1.65 \text{ V to } 1.95 \text{ V}$ | $0.65 \times V_{CC}$ | - | - | V |
| | | $V_{CC} = 2.3 \text{ V to } 2.7 \text{ V}$ | 1.7 | - | - | V |
| | | $V_{CC} = 2.7 \text{ V to } 3.6 \text{ V}$ | 2.0 | - | - | V |
| | | $V_{CC} = 4.5 \text{ V to } 5.5 \text{ V}$ | $0.7 \times V_{CC}$ | - | - | V |
| V_{IL} | LOW-level input voltage | $V_{CC} = 1.65 \text{ V to } 1.95 \text{ V}$ | - | - | $0.35 \times V_{CC}$ | V |
| | | $V_{CC} = 2.3 \text{ V to } 2.7 \text{ V}$ | - | - | 0.7 | V |
| | | $V_{CC} = 2.7 \text{ V to } 3.6 \text{ V}$ | - | - | 0.8 | V |
| | | $V_{CC} = 4.5 \text{ V to } 5.5 \text{ V}$ | - | - | $0.3 \times V_{CC}$ | V |
| V_{OL} | LOW-level output voltage | $V_I = V_{IH} \text{ or } V_{IL}$ | | | | |
| | | $V_{CC} = 1.65 \text{ V to } 5.5 \text{ V}; I_O = 100 \text{ } \mu\text{A}$ | - | - | 0.1 | V |
| | | $V_{CC} = 1.65 \text{ V}; I_O = 4 \text{ mA}$ | - | - | 0.45 | V |
| | | $V_{CC} = 2.3 \text{ V}; I_O = 8 \text{ mA}$ | - | - | 0.3 | V |
| | | $V_{CC} = 2.7 \text{ V}; I_O = 12 \text{ mA}$ | - | - | 0.4 | V |
| | | $V_{CC} = 3.0 \text{ V}; I_O = 24 \text{ mA}$ | - | - | 0.55 | V |
| | | $V_{CC} = 4.5 \text{ V}; I_O = 32 \text{ mA}$ | - | - | 0.55 | V |
| V_{OH} | HIGH-level output voltage | $V_I = V_{IH} \text{ or } V_{IL}$ | | | | |
| | | $V_{CC} = 1.65 \text{ V to } 5.5 \text{ V}; I_O = -100 \text{ } \mu\text{A}$ | $V_{CC} - 0.1$ | - | - | V |
| | | $V_{CC} = 1.65 \text{ V}; I_O = -4 \text{ mA}$ | 1.2 | - | - | V |
| | | $V_{CC} = 2.3 \text{ V}; I_O = -8 \text{ mA}$ | 1.9 | - | - | V |
| | | $V_{CC} = 2.7 \text{ V}; I_O = -12 \text{ mA}$ | 2.2 | - | - | V |
| | | $V_{CC} = 3.0 \text{ V}; I_O = -24 \text{ mA}$ | 2.3 | - | - | V |
| | | $V_{CC} = 4.5 \text{ V}; I_O = -32 \text{ mA}$ | 3.8 | - | - | V |
| I_I | input leakage current | $V_{CC} = 0 \text{ V to } 5.5 \text{ V}; V_I = 5.5 \text{ V or GND}$ | - | ± 0.1 | ± 1 | μA |
| I_{OZ} | OFF-state output current | $V_{CC} = 3.6 \text{ V}; V_I = V_{IH} \text{ or } V_{IL}; V_O = 5.5 \text{ V or GND}$ | - | ± 0.1 | ± 2 | μA |
| I_{OFF} | power-off leakage current | $V_{CC} = 0 \text{ V}; V_I \text{ or } V_O = 5.5 \text{ V}$ | - | ± 0.1 | ± 2 | μA |
| I_{CC} | supply current | $V_I = 5.5 \text{ V or GND}; V_{CC} = 1.65 \text{ V to } 5.5 \text{ V}; I_O = 0 \text{ A}$ | - | 0.1 | 4 | μA |
| ΔI_{CC} | additional supply current | per pin; $V_{CC} = 2.3 \text{ V to } 5.5 \text{ V}; V_I = V_{CC} - 0.6 \text{ V}; I_O = 0 \text{ A}$ | - | 5 | 500 | μA |
| C_I | input capacitance | | - | 5 | - | pF |

| Symbol | Parameter | Conditions | Min | Typ ^[1] | Max | Unit |
|--|---------------------------|---|------------------------|--------------------|------------------------|------|
| T_{amb} = -40 °C to +125 °C | | | | | | |
| V _{IH} | HIGH-level input voltage | V _{CC} = 1.65 V to 1.95 V | 0.65 × V _{CC} | - | - | V |
| | | V _{CC} = 2.3 V to 2.7 V | 1.7 | - | - | V |
| | | V _{CC} = 2.7 V to 3.6 V | 2.0 | - | - | V |
| | | V _{CC} = 4.5 V to 5.5 V | 0.7 × V _{CC} | - | - | V |
| V _{IL} | LOW-level input voltage | V _{CC} = 1.65 V to 1.95 V | - | - | 0.35 × V _{CC} | V |
| | | V _{CC} = 2.3 V to 2.7 V | - | - | 0.7 | V |
| | | V _{CC} = 2.7 V to 3.6 V | - | - | 0.8 | V |
| | | V _{CC} = 4.5 V to 5.5 V | - | - | 0.3 × V _{CC} | V |
| V _{OL} | LOW-level output voltage | V _I = V _{IH} or V _{IL} | | | | |
| | | V _{CC} = 1.65 V to 5.5 V; I _O = 100 μA | - | - | 0.1 | V |
| | | V _{CC} = 1.65 V; I _O = 4 mA | - | - | 0.70 | V |
| | | V _{CC} = 2.3 V; I _O = 8 mA | - | - | 0.45 | V |
| | | V _{CC} = 2.7 V; I _O = 12 mA | - | - | 0.60 | V |
| | | V _{CC} = 3.0 V; I _O = 24 mA | - | - | 0.80 | V |
| | | V _{CC} = 4.5 V; I _O = 32 mA | - | - | 0.80 | V |
| V _{OH} | HIGH-level output voltage | V _I = V _{IH} or V _{IL} | | | | |
| | | V _{CC} = 1.65 V to 5.5 V; I _O = -100 μA | V _{CC} - 0.1 | - | - | V |
| | | V _{CC} = 1.65 V; I _O = -4 mA | 0.95 | - | - | V |
| | | V _{CC} = 2.3 V; I _O = -8 mA | 1.7 | - | - | V |
| | | V _{CC} = 2.7 V; I _O = -12 mA | 1.9 | - | - | V |
| | | V _{CC} = 3.0 V; I _O = -24 mA | 2.0 | - | - | V |
| | | V _{CC} = 4.5 V; I _O = -32 mA | 3.4 | - | - | V |
| I _I | input leakage current | V _{CC} = 0 V to 5.5 V; V _I = 5.5 V or GND | - | - | ±1 | μA |
| I _{OZ} | OFF-state output current | V _{CC} = 3.6 V; V _I = V _{IH} or V _{IL} ; V _O = 5.5 V or GND | - | - | ±2 | μA |
| I _{OFF} | power-off leakage current | V _{CC} = 0 V; V _I or V _O = 5.5 V | - | - | ±2 | μA |
| I _{CC} | supply current | V _I = 5.5 V or GND; V _{CC} = 1.65 V to 5.5 V; I _O = 0 A | - | - | 4 | μA |
| ΔI _{CC} | additional supply current | per pin; V _{CC} = 2.3 V to 5.5 V; V _I = V _{CC} - 0.6 V; I _O = 0 A | - | - | 500 | μA |

[1] All typical values are measured at V_{CC} = 3.3 V and T_{amb} = 25 °C.

11 Dynamic characteristics

Table 8. Dynamic characteristics

Voltages are referenced to GND (ground = 0 V). For test circuit see [Figure 10](#).

| Symbol | Parameter | Conditions | -40 °C to +85 °C | | | -40 °C to +125 °C | | Unit |
|------------------|-------------------------------|--|------------------|--------------------|-----|-------------------|------|------|
| | | | Min | Typ ^[1] | Max | Min | Max | |
| t _{pd} | propagation delay | A to Y; see Figure 8 ^[2] | | | | | | |
| | | V _{CC} = 1.65 V to 1.95 V | 1.0 | 3.3 | 8.0 | 1.0 | 10.5 | ns |
| | | V _{CC} = 2.3 V to 2.7 V | 0.5 | 2.2 | 5.5 | 0.5 | 7 | ns |
| | | V _{CC} = 2.7 V | 0.5 | 2.5 | 5.5 | 0.5 | 7 | ns |
| | | V _{CC} = 3.0 V to 3.6 V | 0.5 | 2.1 | 4.5 | 0.5 | 6 | ns |
| | | V _{CC} = 4.5 V to 5.5 V | 0.5 | 1.7 | 4.0 | 0.5 | 5.5 | ns |
| t _{en} | enable time | OE to Y; see Figure 9 ^[3] | | | | | | |
| | | V _{CC} = 1.65 V to 1.95 V | 1.0 | 4.1 | 9.4 | 1.0 | 12 | ns |
| | | V _{CC} = 2.3 V to 2.7 V | 0.5 | 2.8 | 6.6 | 0.5 | 8.5 | ns |
| | | V _{CC} = 2.7 V | 0.5 | 3.3 | 6.6 | 0.5 | 8.5 | ns |
| | | V _{CC} = 3.0 V to 3.6 V | 0.5 | 2.4 | 5.3 | 0.5 | 7 | ns |
| | | V _{CC} = 4.5 V to 5.5 V | 0.5 | 2.1 | 5.0 | 0.5 | 6.5 | ns |
| t _{dis} | disable time | OE to Y; see Figure 9 ^[4] | | | | | | |
| | | V _{CC} = 1.65 V to 1.95 V | 1.0 | 4.3 | 9.2 | 1.0 | 12 | ns |
| | | V _{CC} = 2.3 V to 2.7 V | 0.5 | 2.7 | 5.0 | 0.5 | 6.5 | ns |
| | | V _{CC} = 2.7 V | 0.5 | 3.0 | 5.0 | 0.5 | 6.5 | ns |
| | | V _{CC} = 3.0 V to 3.6 V | 0.5 | 3.1 | 5.0 | 0.5 | 6.5 | ns |
| | | V _{CC} = 4.5 V to 5.5 V | 0.5 | 2.2 | 4.2 | 0.5 | 5.5 | ns |
| C _{PD} | power dissipation capacitance | per buffer; V _I = GND to V _{CC} ^[5] | | | | | | |
| | | output enabled | - | 25 | - | - | - | pF |
| | | output disabled | - | 6 | - | - | - | pF |

[1] Typical values are measured at T_{amb} = 25 °C and V_{CC} = 1.8 V, 2.5 V, 2.7 V, 3.3 V and 5.0 V respectively.

[2] t_{pd} is the same as t_{PLH} and t_{PHL}

[3] t_{en} is the same as t_{PZH} and t_{PZL}

[4] t_{dis} is the same as t_{PLZ} and t_{PHZ}

[5] C_{PD} is used to determine the dynamic power dissipation (P_D in μW).

$$P_D = C_{PD} \times V_{CC}^2 \times f_i \times N + \sum(C_L \times V_{CC}^2 \times f_o) \text{ where:}$$

f_i = input frequency in MHz;

f_o = output frequency in MHz;

C_L = output load capacitance in pF;

V_{CC} = supply voltage in V;

N = number of inputs switching;

∑(C_L × V_{CC}² × f_o) = sum of outputs.

11.1 Waveforms and test circuit

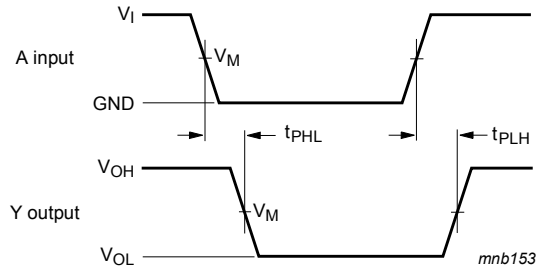

Measurement points are given in [Table 9](#).

V_{OL} and V_{OH} are typical output voltage levels that occur with the output load.

Figure 8. Input A to output Y propagation delay times

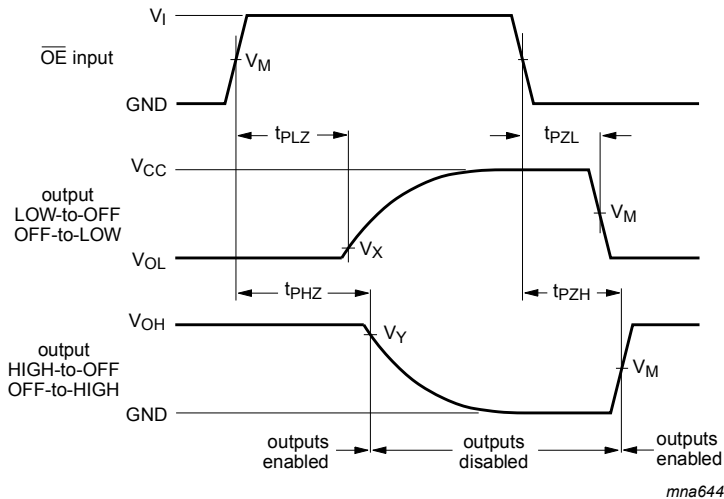

Measurement points are given in [Table 9](#).

V_{OL} and V_{OH} are typical output voltage levels that occur with the output load.

Figure 9. 3-state enable and disable times

Table 9. Measurement points

| Supply voltage | Input | Output | | |
|------------------|-------------|-------------|-------------------|-------------------|
| V_{CC} | V_M | V_M | V_X | V_Y |
| 1.65 V to 1.95 V | $0.5V_{CC}$ | $0.5V_{CC}$ | $V_{OL} + 0.15 V$ | $V_{OH} - 0.15 V$ |
| 2.3 V to 2.7 V | $0.5V_{CC}$ | $0.5V_{CC}$ | $V_{OL} + 0.15 V$ | $V_{OH} - 0.15 V$ |
| 2.7 V | 1.5 V | 1.5 V | $V_{OL} + 0.3 V$ | $V_{OH} - 0.3 V$ |
| 3.0 V to 3.6 V | 1.5 V | 1.5 V | $V_{OL} + 0.3 V$ | $V_{OH} - 0.3 V$ |
| 4.5 V to 5.5 V | $0.5V_{CC}$ | $0.5V_{CC}$ | $V_{OL} + 0.3 V$ | $V_{OH} - 0.3 V$ |

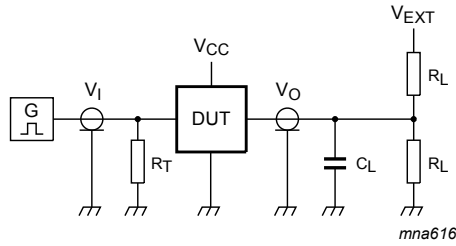

Test data is given in [Table 10](#).

Definitions for test circuit:

R_L = Load resistance.

C_L = Load capacitance including jig and probe capacitance.

R_T = Termination resistance should be equal to the output impedance Z_o of the pulse generator.

V_{EXT} = External voltage for measuring switching times.

Figure 10. Test circuit for measuring switching times

Table 10. Test data

| Supply voltage | Input | Load | | | V_{EXT} | | |
|------------------|----------|---------------|-------|--------------|--------------------|--------------------|--------------------|
| V_{CC} | V_I | t_r, t_f | C_L | R_L | t_{PLH}, t_{PHL} | t_{PZH}, t_{PHZ} | t_{PZL}, t_{PLZ} |
| 1.65 V to 1.95 V | V_{CC} | ≤ 2.0 ns | 30 pF | 1 k Ω | open | GND | $2V_{CC}$ |
| 2.3 V to 2.7 V | V_{CC} | ≤ 2.0 ns | 30 pF | 500 Ω | open | GND | $2V_{CC}$ |
| 2.7 V | 2.7 V | ≤ 2.5 ns | 50 pF | 500 Ω | open | GND | 6 V |
| 3.0 V to 3.6 V | 2.7 V | ≤ 2.5 ns | 50 pF | 500 Ω | open | GND | 6 V |
| 4.5 V to 5.5 V | V_{CC} | ≤ 2.5 ns | 50 pF | 500 Ω | open | GND | $2V_{CC}$ |

12 Package outline

TSSOP5: plastic thin shrink small outline package; 5 leads; body width 1.25 mm

SOT353-1

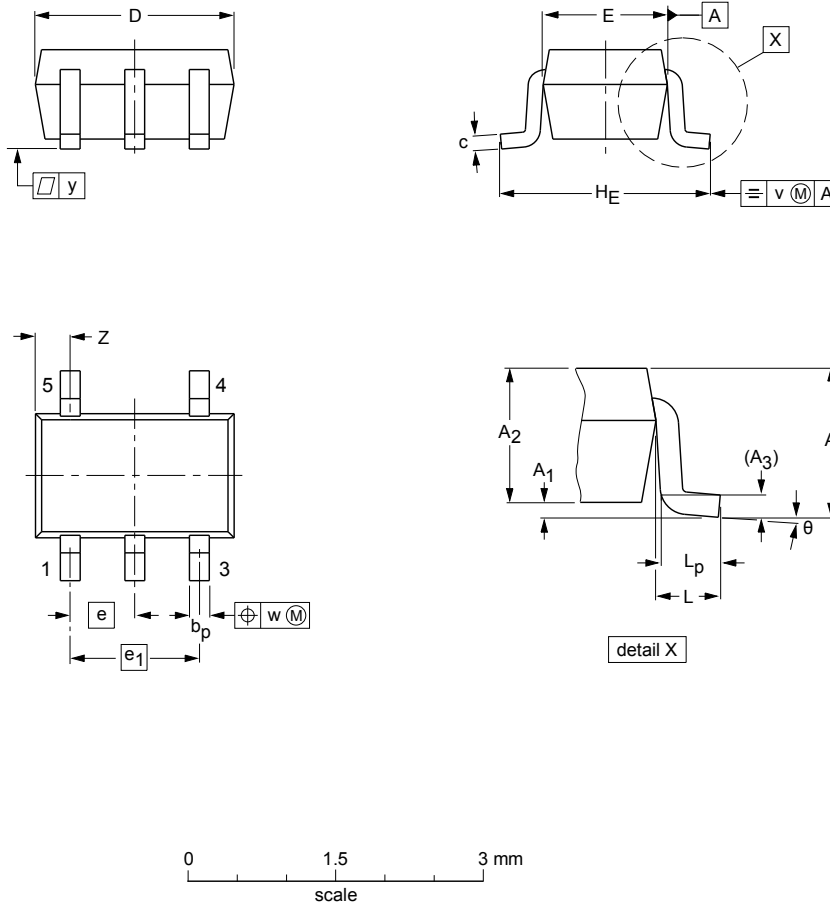

DIMENSIONS (mm are the original dimensions)

| UNIT | A max. | A ₁ | A ₂ | A ₃ | b _p | c | D ⁽¹⁾ | E ⁽¹⁾ | e | e ₁ | H _E | L | L _p | v | w | y | Z ⁽¹⁾ | θ |
|------|--------|----------------|----------------|----------------|----------------|--------------|------------------|------------------|------|----------------|----------------|-------|----------------|-----|-----|-----|------------------|----------|
| mm | 1.1 | 0.1 0 | 1.0 0.8 | 0.15 | 0.30 0.15 | 0.25 0.08 | 2.25 1.85 | 1.35 1.15 | 0.65 | 1.3 | 2.25 2.0 | 0.425 | 0.46 0.21 | 0.3 | 0.1 | 0.1 | 0.60 0.15 | 7° 0° |

Note

1. Plastic or metal protrusions of 0.15 mm maximum per side are not included.

| OUTLINE VERSION | REFERENCES | | | EUROPEAN PROJECTION | ISSUE DATE |
|-----------------|------------|--------|--------|---------------------|----------------------|
| | IEC | JEDEC | JEITA | | |
| SOT353-1 | | MO-203 | SC-88A | | 00-09-01 03-02-19 |

Figure 11. Package outline SOT353-1 (TSSOP5)

Plastic surface-mounted package; 5 leads

SOT753

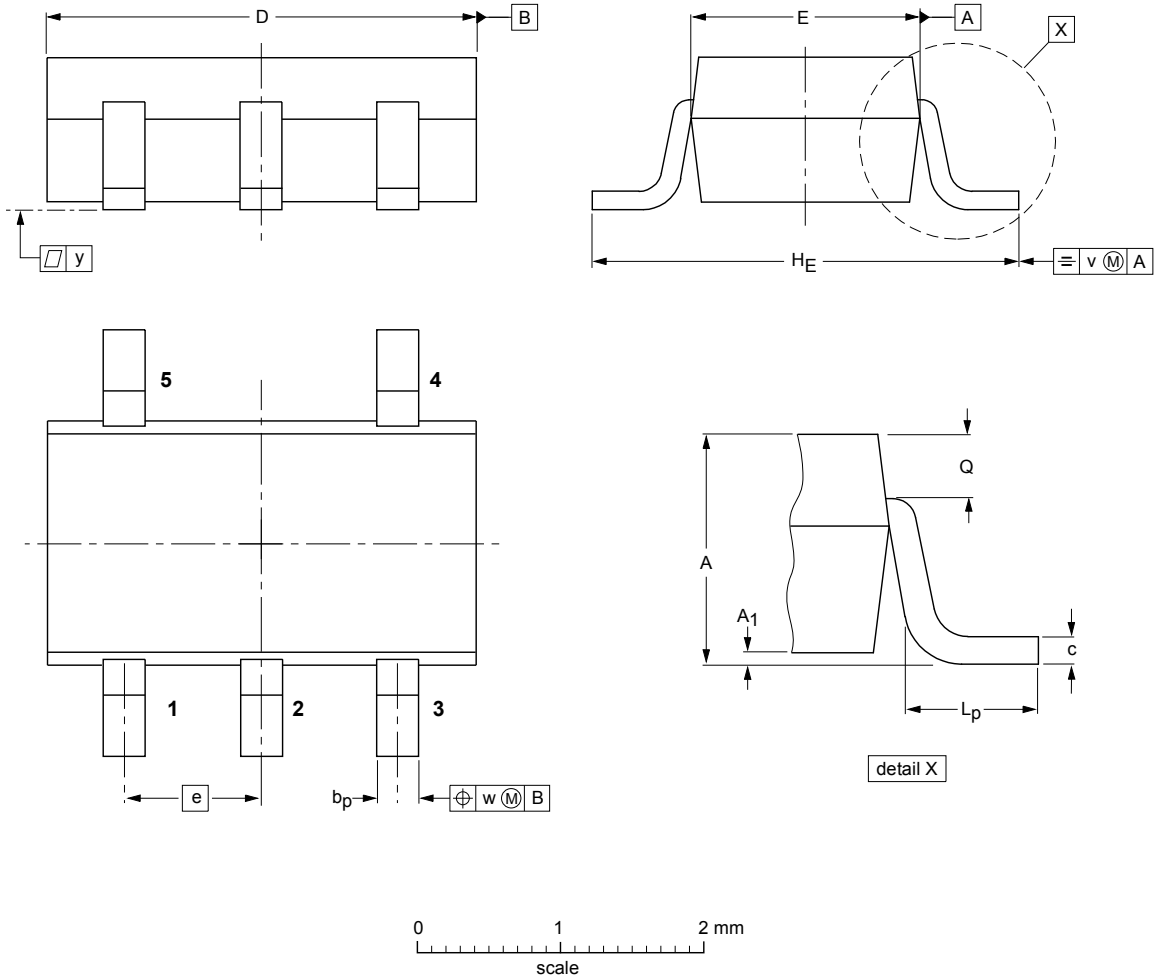

DIMENSIONS (mm are the original dimensions)

| UNIT | A | A ₁ | b _p | c | D | E | e | H _E | L _p | Q | v | w | y |
|------|------------|----------------|----------------|--------------|------------|------------|------|----------------|----------------|--------------|-----|-----|-----|
| mm | 1.1 0.9 | 0.100 0.013 | 0.40 0.25 | 0.26 0.10 | 3.1 2.7 | 1.7 1.3 | 0.95 | 3.0 2.5 | 0.6 0.2 | 0.33 0.23 | 0.2 | 0.2 | 0.1 |

| OUTLINE VERSION | REFERENCES | | | | EUROPEAN PROJECTION | ISSUE DATE |
|-----------------|------------|-------|--------|--|---------------------|-----------------------|
| | IEC | JEDEC | JEITA | | | |
| SOT753 | | | SC-74A | | | -02-04-16 06-03-16 |

Figure 12. Package outline SOT753

XSON6: plastic extremely thin small outline package; no leads; 6 terminals; body 1 x 1.45 x 0.5 mm

SOT886

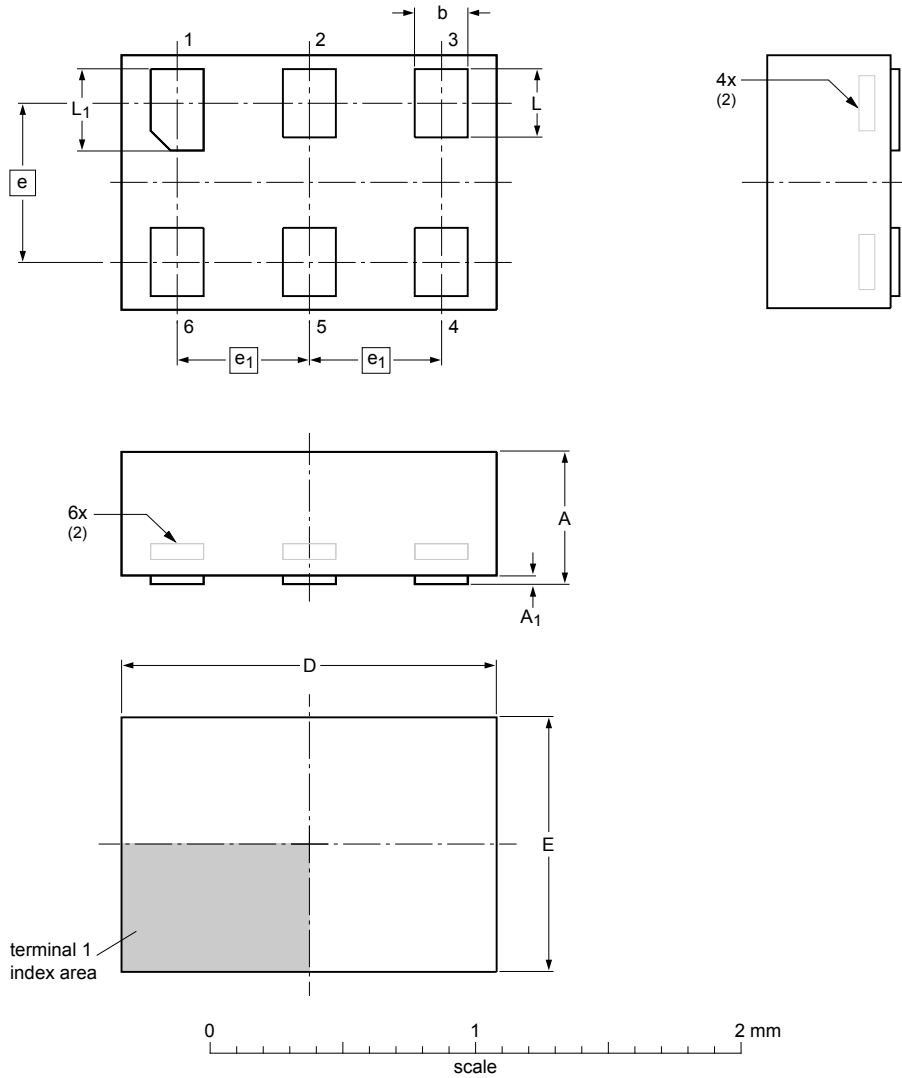

Dimensions (mm are the original dimensions)

| Unit | A ⁽¹⁾ | A ₁ | b | D | E | e | e ₁ | L | L ₁ |
|------|------------------|----------------|------|------|------|-----|----------------|------|----------------|
| max | 0.5 | 0.04 | 0.25 | 1.50 | 1.05 | | | 0.35 | 0.40 |
| nom | | | 0.20 | 1.45 | 1.00 | 0.6 | 0.5 | 0.30 | 0.35 |
| min | | | 0.17 | 1.40 | 0.95 | | | 0.27 | 0.32 |

Notes

- Including plating thickness.
- Can be visible in some manufacturing processes.

sot886_po

| Outline version | References | | | European projection | Issue date |
|-----------------|------------|--------|-------|---------------------|----------------------|
| | IEC | JEDEC | JEITA | | |
| SOT886 | | MO-252 | | | 04-07-22 12-01-05 |

Figure 13. Package outline SOT886 (XSON6)

XSON6: plastic extremely thin small outline package; no leads; 6 terminals; body 1 x 1 x 0.5 mm

SOT891

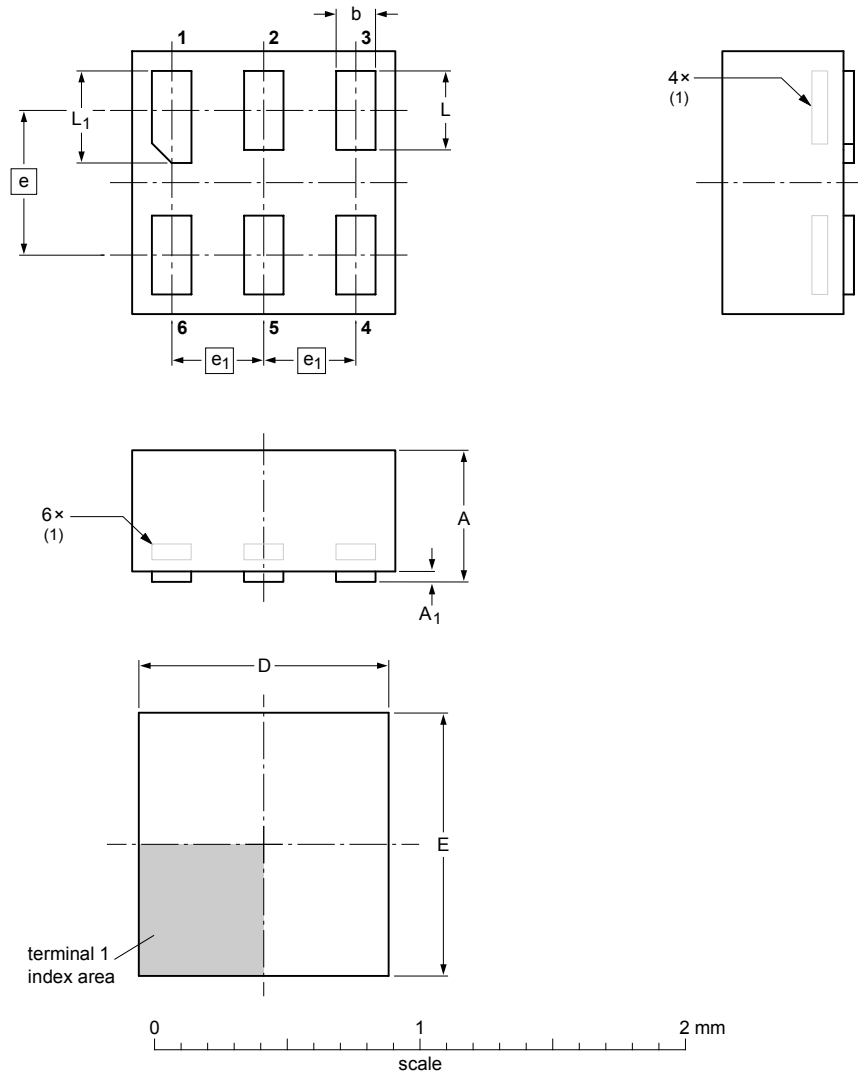

DIMENSIONS (mm are the original dimensions)

| UNIT | A max | A ₁ max | b | D | E | e | e ₁ | L | L ₁ |
|------|----------|-----------------------|--------------|--------------|--------------|------|----------------|--------------|----------------|
| mm | 0.5 | 0.04 | 0.20 0.12 | 1.05 0.95 | 1.05 0.95 | 0.55 | 0.35 | 0.35 0.27 | 0.40 0.32 |

Note

1. Can be visible in some manufacturing processes.

| OUTLINE VERSION | REFERENCES | | | EUROPEAN PROJECTION | ISSUE DATE |
|--------------------|------------|-------|-------|------------------------|-----------------------|
| | IEC | JEDEC | JEITA | | |
| SOT891 | | | | | -05-04-06 07-05-15 |

Figure 14. Package outline SOT891 (XSON6)

XSON6: extremely thin small outline package; no leads;
6 terminals; body 0.9 x 1.0 x 0.35 mm

SOT1115

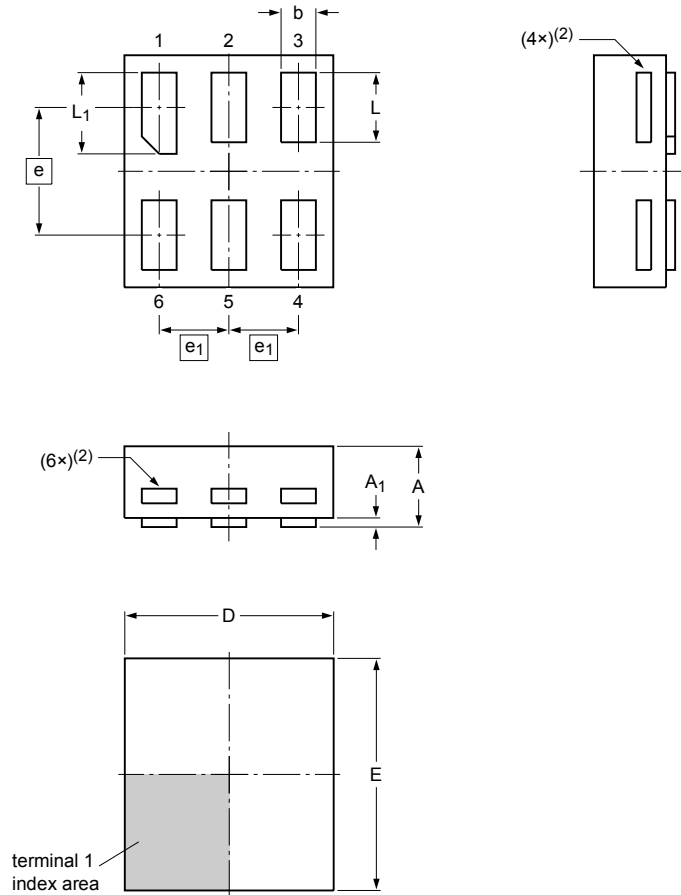

Dimensions

| Unit | A ⁽¹⁾ | A ₁ | b | D | E | e | e ₁ | L | L ₁ |
|------|------------------|----------------|------|------|------|------|----------------|------|----------------|
| mm | max 0.35 | 0.04 | 0.20 | 0.95 | 1.05 | | | 0.35 | 0.40 |
| | nom | | 0.15 | 0.90 | 1.00 | 0.55 | 0.3 | 0.30 | 0.35 |
| | min | | 0.12 | 0.85 | 0.95 | | | 0.27 | 0.32 |

Note

- Including plating thickness.
- Visible depending upon used manufacturing technology.

sot1115_po

| Outline version | References | | | | European projection | Issue date |
|-----------------|------------|-------|-------|--|---------------------|------------------------|
| | IEC | JEDEC | JEITA | | | |
| SOT1115 | | | | | | -10-04-02- 10-04-07 |

Figure 15. Package outline SOT1115 (XSON6)

XSON6: extremely thin small outline package; no leads;
6 terminals; body 1.0 x 1.0 x 0.35 mm

SOT1202

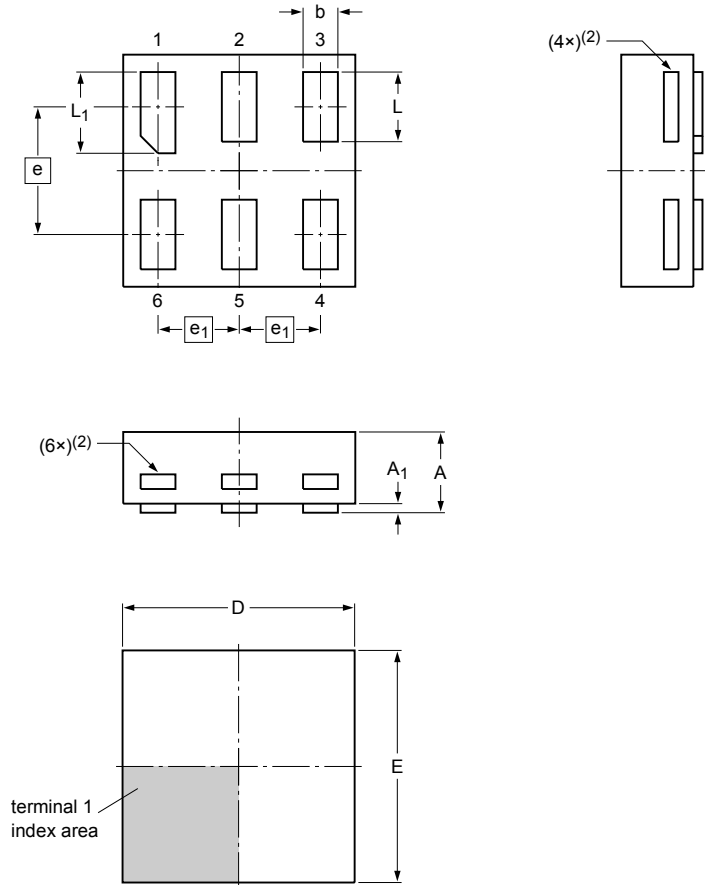

Dimensions

| Unit | A ⁽¹⁾ | A ₁ | b | D | E | e | e ₁ | L | L ₁ |
|------|------------------|----------------|------|------|------|------|----------------|------|----------------|
| mm | max 0.35 | 0.04 | 0.20 | 1.05 | 1.05 | | | 0.35 | 0.40 |
| | nom 0.15 | 1.00 | 1.00 | 0.55 | 0.35 | 0.30 | 0.35 | | |
| | min 0.12 | 0.95 | 0.95 | | | 0.27 | 0.32 | | |

Note

- Including plating thickness.
- Visible depending upon used manufacturing technology.

sot1202_po

| Outline version | References | | | | European projection | Issue date |
|-----------------|------------|-------|-------|--|---------------------|------------------------|
| | IEC | JEDEC | JEITA | | | |
| SOT1202 | | | | | | -10-04-02- 10-04-06 |

Figure 16. Package outline SOT1202 (XSON6)

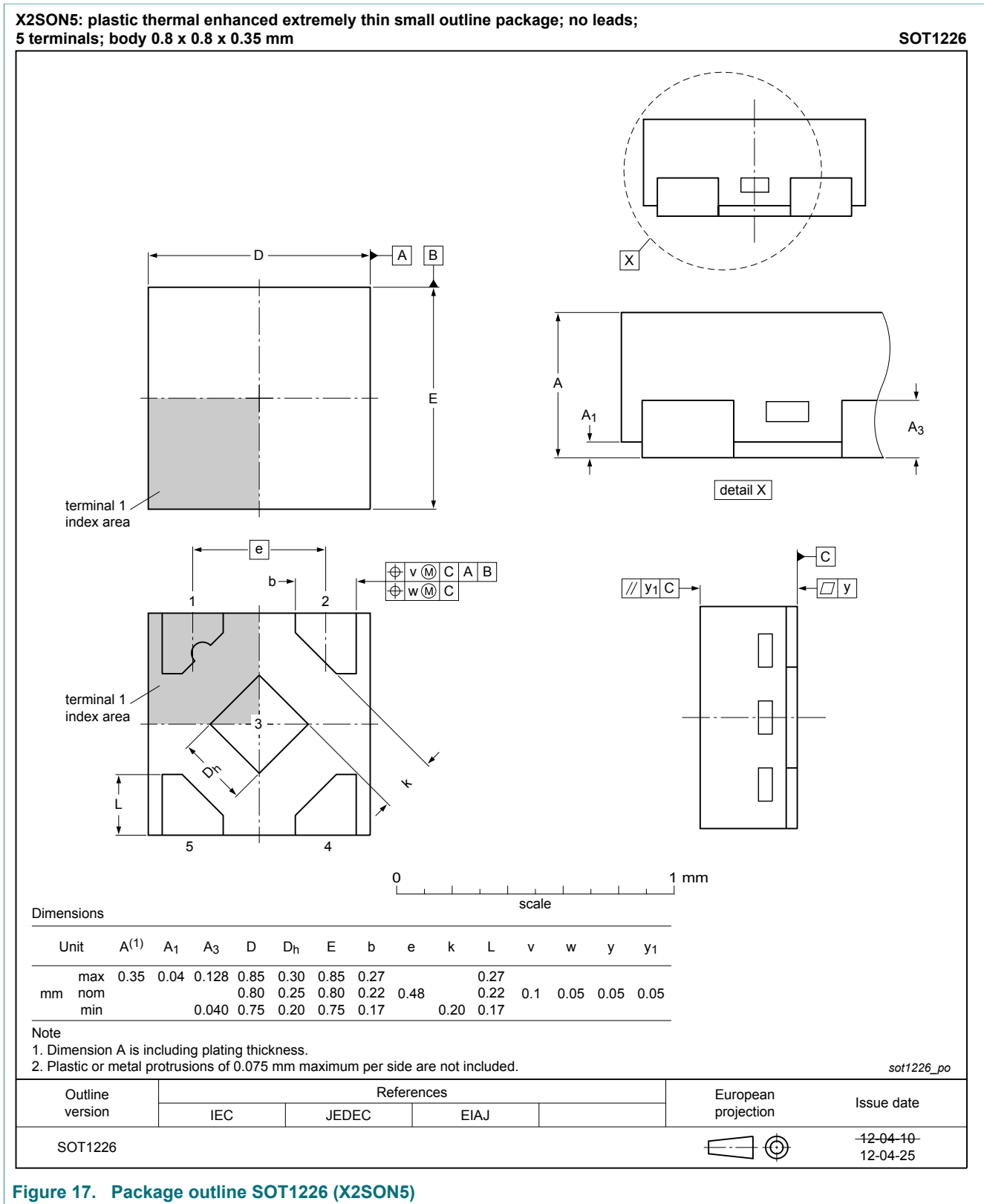

Figure 17. Package outline SOT1226 (X2SON5)

13 Abbreviations

Table 11. Abbreviations

| Acronym | Description |
|---------|---|
| CMOS | Complementary Metal Oxide Semiconductor |
| DUT | Device Under Test |
| ESD | ElectroStatic Discharge |
| HBM | Human Body Model |
| MM | Machine Model |
| TTL | Transistor-Transistor Logic |

14 Revision history

Table 12. Revision history

| Document ID | Release date | Data sheet status | Change notice | Supersedes |
|-----------------|---|-----------------------|---------------|-----------------|
| 74LVC1G125 v.13 | 20171107 | Product data sheet | - | 74LVC1G125 v.12 |
| Modifications: | <ul style="list-style-type: none"> The format of this data sheet has been redesigned to comply with the identity guidelines of Nexperia. Legal texts have been adapted to the new company name where appropriate. | | | |
| 74LVC1G125 v.12 | 20161202 | Product data sheet | - | 74LVC1G125 v.11 |
| Modifications: | <ul style="list-style-type: none"> Table 7: The maximum limits for leakage current and supply current have changed. | | | |
| 74LVC1G125 v.11 | 20120702 | Product data sheet | - | 74LVC1G125 v.10 |
| Modifications: | <ul style="list-style-type: none"> Added type number 74LVC1G125GX (SOT1226) Package outline drawing of SOT886 (Figure 13) modified. | | | |
| 74LVC1G125 v.10 | 20111207 | Product data sheet | - | 74LVC1G125 v.9 |
| Modifications: | <ul style="list-style-type: none"> Legal pages updated. | | | |
| 74LVC1G125 v.9 | 20101229 | Product data sheet | - | 74LVC1G125 v.8 |
| 74LVC1G125 v.8 | 20100824 | Product data sheet | - | 74LVC1G125 v.7 |
| 74LVC1G125 v.7 | 20070830 | Product data sheet | - | 74LVC1G125 v.6 |
| 74LVC1G125 v.6 | 20060912 | Product data sheet | - | 74LVC1G125 v.5 |
| 74LVC1G125 v.5 | 20040915 | Product specification | - | 74LVC1G125 v.4 |
| 74LVC1G125 v.4 | 20021118 | Product specification | - | 74LVC1G125 v.3 |
| 74LVC1G125 v.3 | 20020528 | Product specification | - | 74LVC1G125 v.2 |
| 74LVC1G125 v.2 | 20010406 | Product specification | - | 74LVC1G125 v.1 |
| 74LVC1G125 v.1 | 20001222 | Product specification | - | - |

15 Legal information

15.1 Data sheet status

| Document status ^{[1][2]} | Product status ^[3] | Definition |
|-----------------------------------|-------------------------------|---|
| Objective [short] data sheet | Development | This document contains data from the objective specification for product development. |
| Preliminary [short] data sheet | Qualification | This document contains data from the preliminary specification. |
| Product [short] data sheet | Production | This document contains the product specification. |

[1] Please consult the most recently issued document before initiating or completing a design.

[2] The term 'short data sheet' is explained in section "Definitions".

[3] The product status of device(s) described in this document may have changed since this document was published and may differ in case of multiple devices. The latest product status information is available on the Internet at URL <http://www.nexperia.com>.

15.2 Definitions

Draft — The document is a draft version only. The content is still under internal review and subject to formal approval, which may result in modifications or additions. Nexperia does not give any representations or warranties as to the accuracy or completeness of information included herein and shall have no liability for the consequences of use of such information.

Short data sheet — A short data sheet is an extract from a full data sheet with the same product type number(s) and title. A short data sheet is intended for quick reference only and should not be relied upon to contain detailed and full information. For detailed and full information see the relevant full data sheet, which is available on request via the local Nexperia sales office. In case of any inconsistency or conflict with the short data sheet, the full data sheet shall prevail.

Product specification — The information and data provided in a Product data sheet shall define the specification of the product as agreed between Nexperia and its customer, unless Nexperia and customer have explicitly agreed otherwise in writing. In no event however, shall an agreement be valid in which the Nexperia product is deemed to offer functions and qualities beyond those described in the Product data sheet.

15.3 Disclaimers

Limited warranty and liability — Information in this document is believed to be accurate and reliable. However, Nexperia does not give any representations or warranties, expressed or implied, as to the accuracy or completeness of such information and shall have no liability for the consequences of use of such information. Nexperia takes no responsibility for the content in this document if provided by an information source outside of Nexperia. In no event shall Nexperia be liable for any indirect, incidental, punitive, special or consequential damages (including - without limitation - lost profits, lost savings, business interruption, costs related to the removal or replacement of any products or rework charges) whether or not such damages are based on tort (including negligence), warranty, breach of contract or any other legal theory. Notwithstanding any damages that customer might incur for any reason whatsoever, Nexperia's aggregate and cumulative liability towards customer for the products described herein shall be limited in accordance with the Terms and conditions of commercial sale of Nexperia.

Right to make changes — Nexperia reserves the right to make changes to information published in this document, including without limitation specifications and product descriptions, at any time and without notice. This document supersedes and replaces all information supplied prior to the publication hereof.

Suitability for use — Nexperia products are not designed, authorized or warranted to be suitable for use in life support, life-critical or safety-critical

systems or equipment, nor in applications where failure or malfunction of an Nexperia product can reasonably be expected to result in personal injury, death or severe property or environmental damage. Nexperia and its suppliers accept no liability for inclusion and/or use of Nexperia products in such equipment or applications and therefore such inclusion and/or use is at the customer's own risk.

Applications — Applications that are described herein for any of these products are for illustrative purposes only. Nexperia makes no representation or warranty that such applications will be suitable for the specified use without further testing or modification. Customers are responsible for the design and operation of their applications and products using Nexperia products, and Nexperia accepts no liability for any assistance with applications or customer product design. It is customer's sole responsibility to determine whether the Nexperia product is suitable and fit for the customer's applications and products planned, as well as for the planned application and use of customer's third party customer(s). Customers should provide appropriate design and operating safeguards to minimize the risks associated with their applications and products. Nexperia does not accept any liability related to any default, damage, costs or problem which is based on any weakness or default in the customer's applications or products, or the application or use by customer's third party customer(s). Customer is responsible for doing all necessary testing for the customer's applications and products using Nexperia products in order to avoid a default of the applications and the products or of the application or use by customer's third party customer(s). Nexperia does not accept any liability in this respect.

Limiting values — Stress above one or more limiting values (as defined in the Absolute Maximum Ratings System of IEC 60134) will cause permanent damage to the device. Limiting values are stress ratings only and (proper) operation of the device at these or any other conditions above those given in the Recommended operating conditions section (if present) or the Characteristics sections of this document is not warranted. Constant or repeated exposure to limiting values will permanently and irreversibly affect the quality and reliability of the device.

Terms and conditions of commercial sale — Nexperia products are sold subject to the general terms and conditions of commercial sale, as published at <http://www.nexperia.com/profile/terms>, unless otherwise agreed in a valid written individual agreement. In case an individual agreement is concluded only the terms and conditions of the respective agreement shall apply. Nexperia hereby expressly objects to applying the customer's general terms and conditions with regard to the purchase of Nexperia products by customer.

No offer to sell or license — Nothing in this document may be interpreted or construed as an offer to sell products that is open for acceptance or the grant, conveyance or implication of any license under any copyrights, patents or other industrial or intellectual property rights.

Export control — This document as well as the item(s) described herein may be subject to export control regulations. Export might require a prior authorization from competent authorities.

Non-automotive qualified products — Unless this data sheet expressly states that this specific Nexperia product is automotive qualified, the product is not suitable for automotive use. It is neither qualified nor tested in accordance with automotive testing or application requirements. Nexperia accepts no liability for inclusion and/or use of non-automotive qualified products in automotive equipment or applications. In the event that customer uses the product for design-in and use in automotive applications to automotive specifications and standards, customer (a) shall use the product without Nexperia's warranty of the product for such automotive applications, use and specifications, and (b) whenever customer uses the product for automotive applications beyond Nexperia's specifications such use shall be solely at customer's own risk, and (c) customer fully indemnifies Nexperia for any liability, damages or failed product claims resulting from customer

design and use of the product for automotive applications beyond Nexperia's standard warranty and Nexperia's product specifications.

Translations — A non-English (translated) version of a document is for reference only. The English version shall prevail in case of any discrepancy between the translated and English versions.

15.4 Trademarks

Notice: All referenced brands, product names, service names and trademarks are the property of their respective owners.

Contents

| | | |
|------|--|----|
| 1 | General description | 1 |
| 2 | Features and benefits | 1 |
| 3 | Ordering information | 2 |
| 4 | Marking | 2 |
| 5 | Functional diagram | 2 |
| 6 | Pinning information | 3 |
| 6.1 | Pinning | 3 |
| 6.2 | Pin description | 3 |
| 7 | Functional description | 4 |
| 8 | Limiting values | 4 |
| 9 | Recommended operating conditions | 4 |
| 10 | Static characteristics | 5 |
| 11 | Dynamic characteristics | 7 |
| 11.1 | Waveforms and test circuit | 8 |
| 12 | Package outline | 10 |
| 13 | Abbreviations | 17 |
| 14 | Revision history | 17 |
| 15 | Legal information | 18 |

Please be aware that important notices concerning this document and the product(s) described herein, have been included in section 'Legal information'.

© Nexperia B.V. 2017.

All rights reserved.

For more information, please visit: <http://www.nexperia.com>

For sales office addresses, please send an email to: salesaddresses@nexperia.com

Date of release: 6 November 2017
Document identifier: 74LVC1G125



Компания «ЭлектроПласт» предлагает заключение долгосрочных отношений при поставках импортных электронных компонентов на взаимовыгодных условиях!

Наши преимущества:

- Оперативные поставки широкого спектра электронных компонентов отечественного и импортного производства напрямую от производителей и с крупнейших мировых складов;
- Поставка более 17-ти миллионов наименований электронных компонентов;
- Поставка сложных, дефицитных, либо снятых с производства позиций;
- Оперативные сроки поставки под заказ (от 5 рабочих дней);
- Экспресс доставка в любую точку России;
- Техническая поддержка проекта, помощь в подборе аналогов, поставка прототипов;
- Система менеджмента качества сертифицирована по Международному стандарту ISO 9001;
- Лицензия ФСБ на осуществление работ с использованием сведений, составляющих государственную тайну;
- Поставка специализированных компонентов (Xilinx, Altera, Analog Devices, Intersil, Interpoint, Microsemi, Aeroflex, Peregrine, Syfer, Eurofarad, Texas Instrument, Miteq, Cobham, E2V, MA-COM, Hittite, Mini-Circuits, General Dynamics и др.);

Помимо этого, одним из направлений компании «ЭлектроПласт» является направление «Источники питания». Мы предлагаем Вам помощь Конструкторского отдела:

- Подбор оптимального решения, техническое обоснование при выборе компонента;
- Подбор аналогов;
- Консультации по применению компонента;
- Поставка образцов и прототипов;
- Техническая поддержка проекта;
- Защита от снятия компонента с производства.



Как с нами связаться

Телефон: 8 (812) 309 58 32 (многоканальный)

Факс: 8 (812) 320-02-42

Электронная почта: org@eplast1.ru

Адрес: 198099, г. Санкт-Петербург, ул. Калинина, дом 2, корпус 4, литера А.