

Description

The DGD2136 is a three-phase gate driver IC designed for high-voltage / high-speed applications, driving N-Channel MOSFETs and IGBTs in a half-bridge configuration. High-voltage processing techniques enable the DGD2136's high-side to switch to 600V in a bootstrap operation.

The DGD2136 logic inputs are compatible with standard TTL and CMOS levels (down to 3.3V) for easy interfacing with controlling devices and are enabled low to better function in high noise environments. The driver outputs feature high-pulse current buffers designed for minimum driver cross conduction.

The DGD2136 offers numerous protection functions. A shoot-through protection logic prevents both outputs from being high when both inputs are high (fault state), an undervoltage lockout for VCC shuts down the respective high side output. An overcurrent protection will terminate the six outputs. Both the VCC UVLO and the overcurrent protection trip an automatic fault clear with a timing that is adjustable with an external capacitor.

The DGD2136 is offered in SO-28 (Type TH) package and the operating temperature extends from -40°C to +125°C.

Applications

- 3-Phase Motor Inverter Driver
- White Goods – Air Conditioner, Washing Machine, Refrigerator
- Industrial Motor Inverter – Power Tools, Robotics
- General Purpose 3-Phase Inverter

Features

- Three Floating High-Side Drivers in Bootstrap Operation to 600V
- 200mA Source / 350mA Sink Output Current Capability
- Outputs Tolerant to Negative Transients, dV/dt Immune
- Logic Input 3.3V Capability
- Internal Deadtime of 290ns to Protect MOSFETs
- Matched Prop Delay for All Channels
- Outputs Out of Phase with Inputs
- Schmitt Triggered Logic Inputs
- Cross Conduction Prevention Logic
- Undervoltage Lockout for All Channels
- Overcurrent Protection Shuts Down Drivers
- Extended Temperature Range: -40°C to +125°C
- **Totally Lead-Free & Fully RoHS Compliant (Notes 1 & 2)**
- **Halogen and Antimony Free. "Green" Device (Note 3)**

Mechanical Data

- Case: SO-28 (Type TH)
- Case Material: Molded Plastic. "Green" Molding Compound.
- UL Flammability Classification Rating 94V-0
- Moisture Sensitivity: Level 3 per J-STD-020
- Terminals: Finish – Matte Tin Plated Leads, Solderable per MIL-STD-202, Method 208
- Weight: 0.250 grams (Approximate)

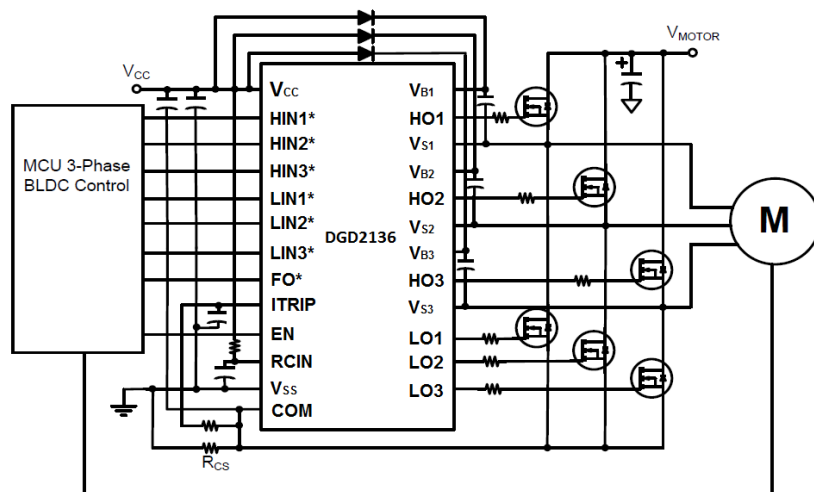

Typical Configuration

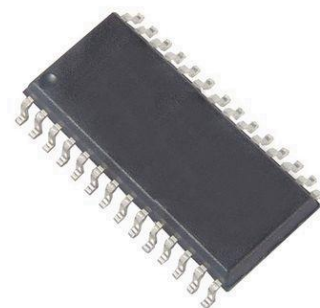

SO-28 (Type TH)

Top View

Ordering Information (Note 4)

Product	Marking	Reel Size (inches)	Tape Width (mm)	Quantity per Reel
DGD2136S28-13	DGD2136	13	24	1,500

- Notes:
1. No purposely added lead. Fully EU Directive 2002/95/EC (RoHS) & 2011/65/EU (RoHS 2) compliant.
 2. See http://www.diodes.com/quality/lead_free.html for more information about Diodes Incorporated's definitions of Halogen- and Antimony-free, "Green" and Lead-free.
 3. Halogen- and Antimony-free "Green" products are defined as those which contain <900ppm bromine, <900ppm chlorine (<1500ppm total Br + Cl) and <1000ppm antimony compounds.
 4. For packaging details, go to our website at <https://www.diodes.com/design/support/packaging/diodes-packaging/>.

Marking Information

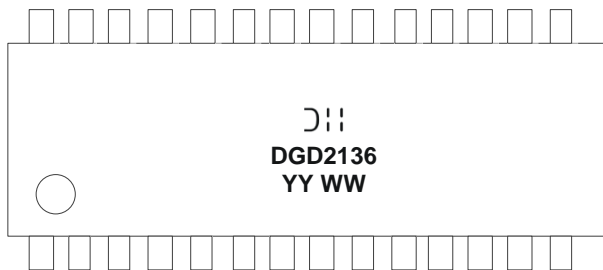

D|| = Manufacturer's Marking
 DGD2136 = Product Type Marking Code
 YY = Year (ex: 17 = 2017)
 WW = Week (01 to 53)

Pin Diagrams

Top View

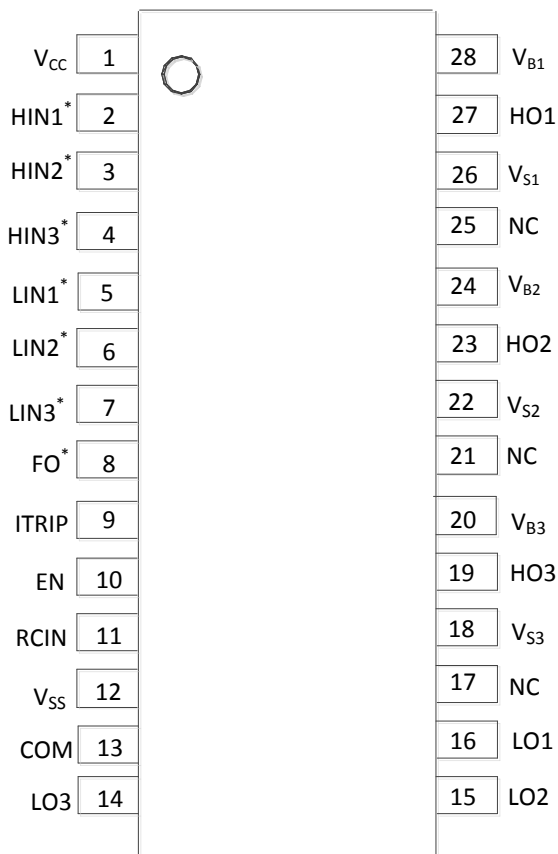

SO-28 (Type TH)

Pin Descriptions

Pin Number	Pin Name	Function
1	V _{CC}	Low-Side and Logic Fixed Supply
2,3,4	HIN1*,HIN2*,HIN3*	Logic Input for High-Side Gate Driver Output, Out of Phase with HO
5,6,7	LIN1*,LIN2*,LIN3*	Logic Input for Low-Side Gate Driver Output, Out of Phase with LO
8	FO*	Fault Output with Open Drain (Fault with Overcurrent and V _{CC} UVLO)
9	ITRIP	Analog Input for Overcurrent Shutdown
10	EN	Logic Input for Functionality, I/O Logic Functions when EN is High
11	RCIN	An External RC Network Input used to Define FAULT CLEAR Delay
12	V _{SS}	Logic Ground
13	COM	Low-Side Driver Return
14,15,16	LO3,LO2,LO1	Low-Side Gate Driver Output
17,21,25	NC	No Connection (No Internal Connection)
18,22,26	V _{S3} , V _{S2} , V _{S1}	High-Side Floating Supply Return
19,23,27	HO3,HO2,HO1	High-Side Gate Driver Output
20,24,28	V _{B3} , V _{B2} , V _{B1}	High-Side Floating Supply

Functional Block Diagram

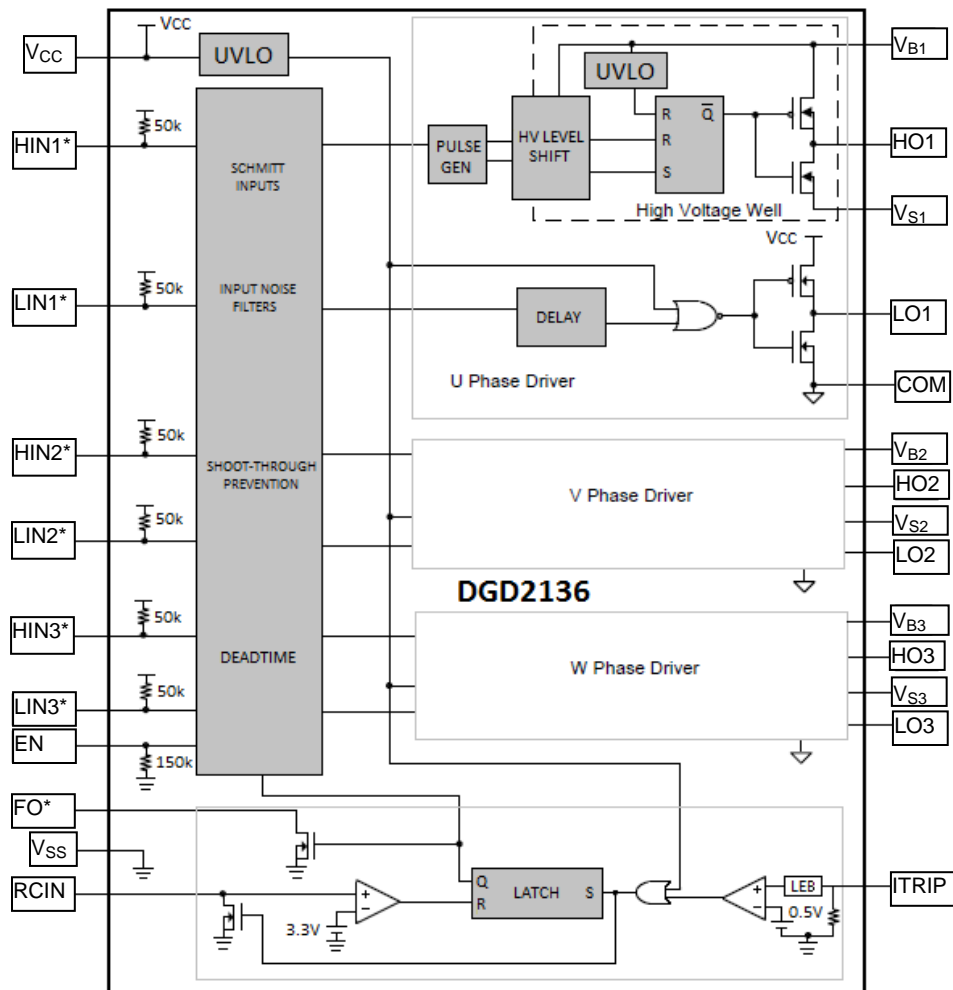

Absolute Maximum Ratings (@T_A = +25°C, unless otherwise specified.)

Characteristic	Symbol	Value	Unit
High-Side Floating Supply Voltage	V _B	-0.3 to +624	V
High-Side Floating Supply Offset Voltage	V _S	V _B -24 to V _B +0.3	V
High-Side Floating Output Voltage	V _{HO}	V _S -0.3 to V _B +0.3	V
Low-Side Output Voltage	V _{LO}	-0.3 to V _{CC} +0.3	V
Offset Supply Voltage Transient	dV _S / dt	50	V/ns
Low-Side Fixed Supply Voltage	V _{CC}	-0.3 to +24	V
Logic Input Voltage (HIN*, LIN*, ITRIP, EN and FO*)	V _{IN}	-0.3 to +5.5	V

Thermal Characteristics (@T_A = +25°C, unless otherwise specified.)

Characteristic	Symbol	Value	Unit
Power Dissipation Linear derating factor (Note 5)	P _D	2.3	W
Thermal Resistance, Junction to Ambient (Note 5)	R _{θJA}	60	°C/W
Thermal Resistance, Junction to Case (Note 5)	R _{θJC}	45	°C/W
Operating Temperature	T _J	+150	°C
Lead Temperature (Soldering, 10s)	T _L	+300	
Storage Temperature Range	T _{STG}	-55 to +150	

Note: 5. When mounted on a standard JEDEC 2-layer FR-4 board.

Recommended Operating Conditions

Parameter	Symbol	Min	Max	Unit
High-Side Floating Supply Absolute Voltage	V _B	V _S + 10	V _S + 20	V
High-Side Floating Supply Offset Voltage	V _S	(Note 6)	600	V
High-Side Floating Output Voltage	V _{HO}	V _S	V _B	V
Low-Side Fixed Supply Voltage	V _{CC}	10	20	V
Low-Side Output Voltage	V _{LO}	COM	V _{CC}	V
Logic Input Voltage (HIN*, LIN*, ITRIP & EN)	V _{IN}	V _{SS}	5	V
Fault Output Voltage	V _{FO}	V _{SS}	V _{CC}	V
Logic Ground	V _{SS}	-5	5	V
Ambient Temperature	T _A	-40	+125	°C

Note: 6. Logic operation for V_S of -5V to +600V. Logic state held for V_S of -5V to -V_Bs.

DC Electrical Characteristics (V_{BIAS} (V_{CC} , V_{BS}) = 15V, @ T_A = +25°C, unless otherwise specified.) (Note 7)

Parameter	Symbol	Min	Typ	Max	Unit	Condition
Logic "0" Input Voltage	V_{IH}	2.4	–	–	V	–
Logic "1" Input Voltage	V_{IL}	–	–	0.8	V	–
High Level Output Voltage, $V_{BIAS} - V_O$	V_{OH}	–	–	0.1	V	$I_O = 0mA$
Low Level Output Voltage, V_O	V_{OL}	–	–	0.1	V	$I_O = 0mA$
Offset Supply Leakage Current	I_{LK}	–	–	10	μA	$V_B = V_S = 600V$
Quiescent V_{BS} Supply Current	I_{BSQ}	10	85	130	μA	$V_{IN} = 0V$ or $5V$, $EN = 0V$
Quiescent V_{CC} Supply Current	I_{CCQ}	–	1.1	1.6	mA	$V_{IN} = 0V$ or $5V$, $EN = 0V$
Logic Input Bias Current (HO=LO=HIGH)	I_{IN+}	–	130	200	μA	$V_{IN} = 0V$
Logic Input Bias Current (HO=LO=LOW)	I_{IN-}	–	3.0	20	μA	$V_{IN} = 5V$
Logic Enable "1" Input Bias Current	I_{EN+}	–	33	80	μA	$V_{EN} = 5V$
Logic Enable "0" Input Bias Current	I_{EN-}	–	–	2.0	μA	$V_{EN} = 0V$
V_{BS} Supply Undervoltage Positive Going Threshold	V_{BSUV+}	7.6	8.9	9.9	V	–
V_{BS} Supply Undervoltage Negative Going Threshold	V_{BSUV-}	7.1	8.3	9.4	V	–
V_{CC} Supply Undervoltage Positive Going Threshold	V_{CCUV+}	7.6	8.9	9.9	V	–
V_{CC} Supply Undervoltage Negative Going Threshold	V_{CCUV-}	7.1	8.3	9.4	V	–
Output High Short Circuit Pulsed Current	I_{O+}	120	200	–	mA	$V_O = 0V$, $PW \leq 10\mu s$
Output Low Short Circuit Pulsed Current	I_{O-}	250	350	–	mA	$V_O = 15V$, $PW \leq 10\mu s$
Overcurrent Detect Positive Threshold	V_{ITH+}	400	500	600	mV	–
Overcurrent Detect Negative Threshold	V_{ITH-}	340	420	500	mV	–
Short-Circuit Input Current	I_{CSIN}	6.0	11	16	μA	$V_{CSIN} = 1V$
RCIN Positive Going Threshold Voltage	$V_{RCINTH+}$	7.0	8.4	9.8	V	–
RCIN Negative Going Threshold Voltage	$V_{RCINTH-}$	–	5.0	–	V	–
Fault Output Low Level Voltage	V_{FOL}	–	0.2	0.5	V	$V_{CS} = 1V$, $I_{FO} = 1.5mA$
RCIN on Resistance	R_{DSRCIN}	40	75	110	Ω	$I_{RCIN} = 1.5mA$
Fault Output on Resistance	R_{DSFO}	80	130	180	Ω	$I_{FO} = 1.5mA$

Note: 7. The V_{IN} , V_{TH} and I_{IN} parameters are referenced to V_{SS} and are applicable to all six channels (HIN1*, 2*, 3* and LIN1*, 2*, 3*). The V_O and I_O parameters are applicable to the output pins (HO1, 2, 3 and LO1, 2, 3) and are referenced to COM.

AC Electrical Characteristics (V_{BIAS} (V_{CC} , V_{BS}) = 15V, $C_L = 1000pF$, @ T_A = +25°C, unless otherwise specified.)

Parameter	Symbol	Min	Typ	Max	Unit	Condition
Turn-On Propagation Delay	t_{ON}	200	330	460	ns	$V_S = 0V$
Turn-Off Propagation Delay	t_{OFF}	200	330	460	ns	$V_S = 0V$
Turn-On Rise Time	t_R	–	90	150	ns	$V_S = 0V$
Turn-Off Fall Time	t_F	–	35	60	ns	$V_S = 0V$
Delay Matching	t_{DM}	–	–	50	ns	–
Enable Low to Output Shutdown Delay	t_{EN}	225	300	425	ns	–
ITRIP Pin Leading-Edge Blanking Time	t_{BLT}	200	300	400	ns	–
Time from ITRIP Triggering to FO*	t_{FLT}	360	550	760	ns	From $V_{ITRIP} = 1V$ to FO* turn off
Time from ITRIP Triggering to All Gate Outputs Turn Off	t_{ITRIP}	420	615	820	ns	From $V_{ITRIP} = 1V$ to starting gate turn off
Input Filtering Time (HIN*, LIN*, EN)	t_{FLTIN}	–	250	–	ns	–
Fault Clear Time	t_{FLTCLR}	–	1.6	–	ms	$C_{RCIN} = 1nF$, $R_{RCIN} = 2M\Omega$
Deadtime	t_{DT}	200	290	420	ns	–
Deadtime Matching	t_{DTM}	–	–	50	ns	–
Output Pulse Width Matching (Note 8)	t_{PM}	–	50	75	ns	$PW_{IN} > 1\mu s$

Note: 8. t_{PM} is defined as $PW_{IN} - PW_{OUT}$.

Timing Waveforms

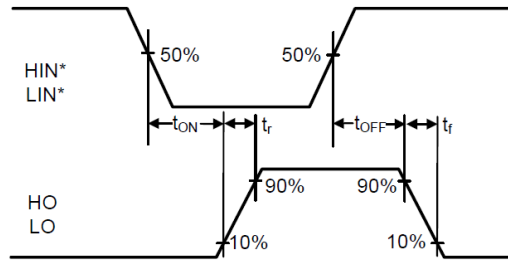

Figure 1. Switching Time Waveform Definitions

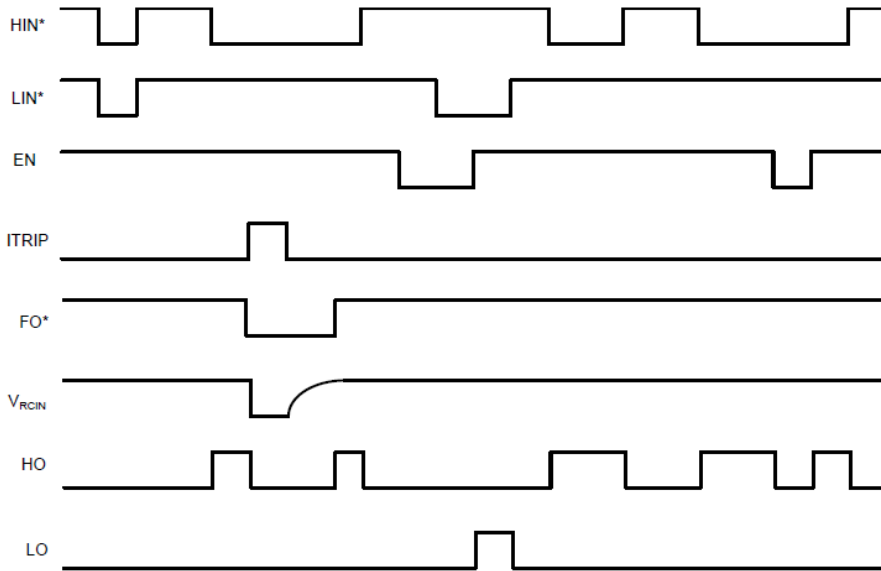

Figure 2. Input/Output Timing Diagram

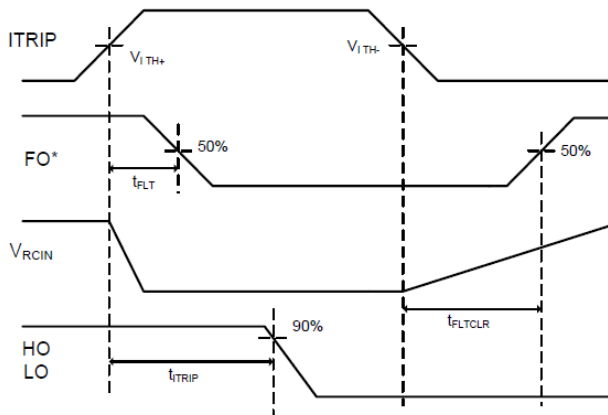

Figure 3. Overcurrent Timing Definitions

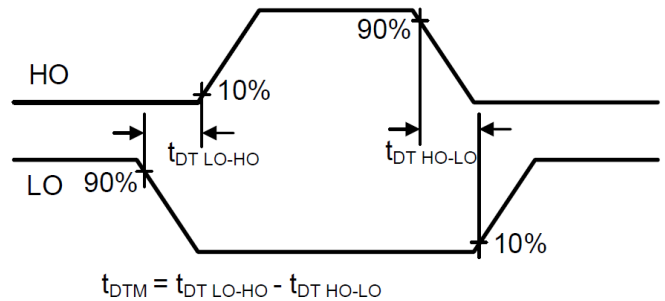

Figure 4. Deadtime Waveform Definitions

Typical Performance Characteristics (@T_A = +25°C, unless otherwise specified.)

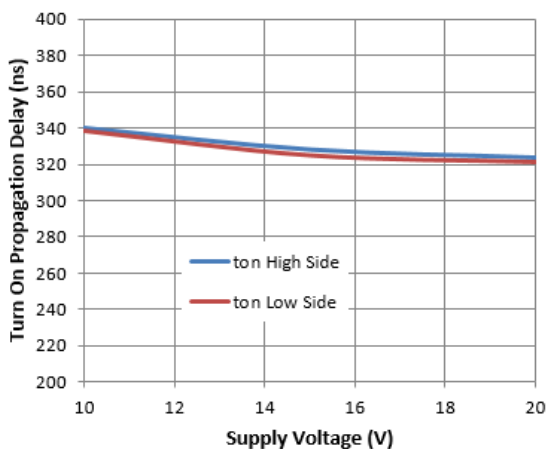

Figure 5. Turn-on Propagation Delay vs. Supply Voltage

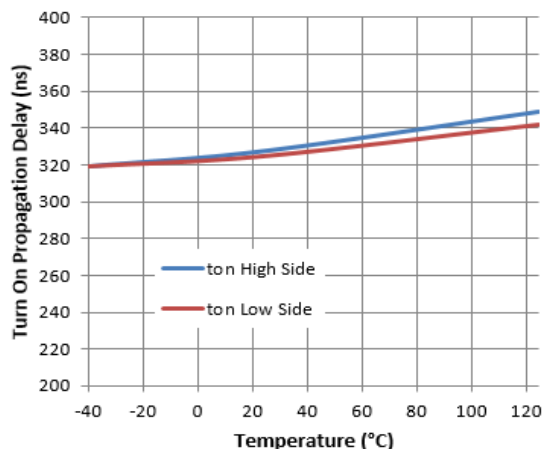

Figure 6. Turn-on Propagation Delay vs. Temperature

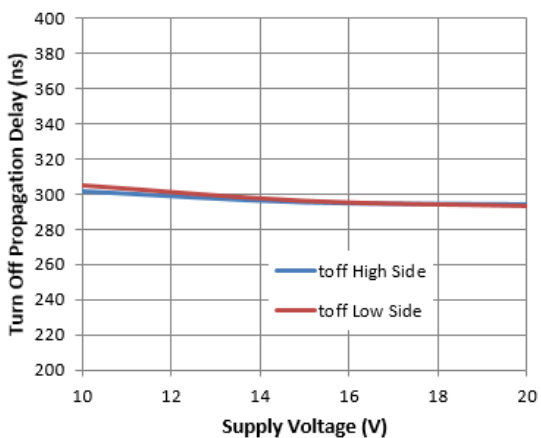

Figure 7. Turn-off Propagation Delay vs. Supply Voltage

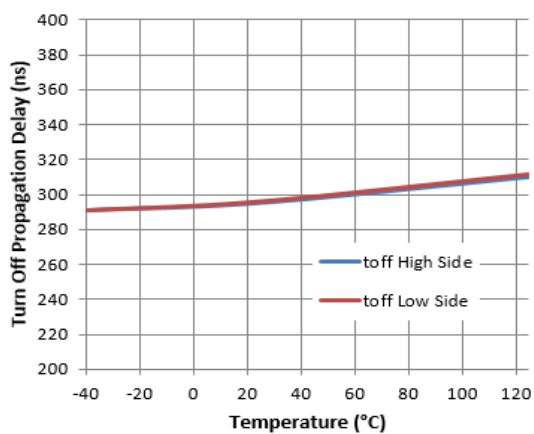

Figure 8. Turn-off Propagation Delay vs. Temperature

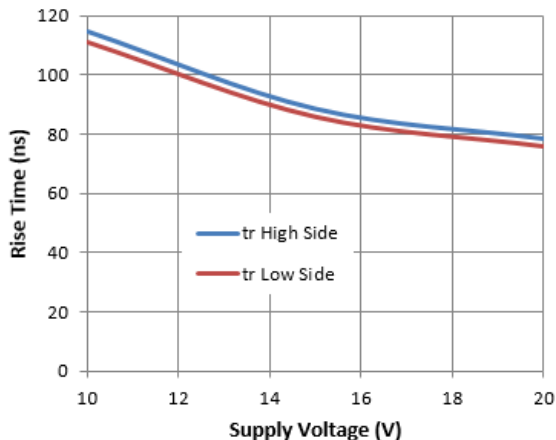

Figure 9. Rise Time vs. Supply Voltage

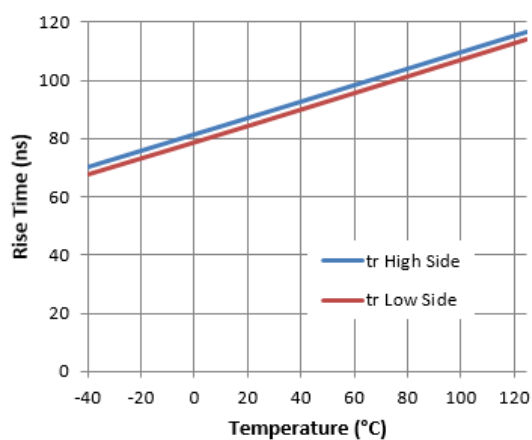

Figure 10. Rise Time vs. Temperature

Typical Performance Characteristics (Cont.)

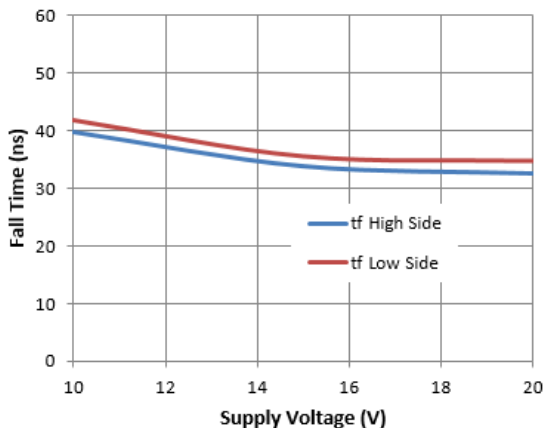

Figure 11. Fall Time vs. Supply Voltage

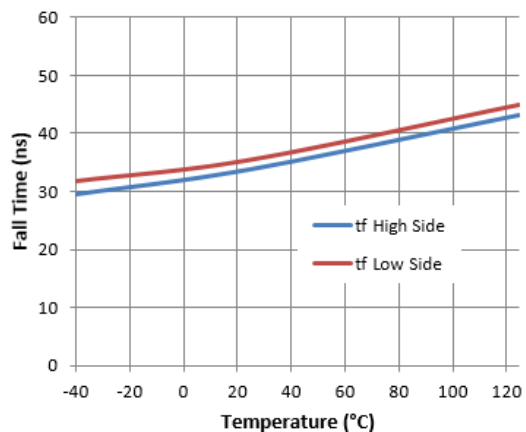

Figure 12. Fall Time vs. Temperature

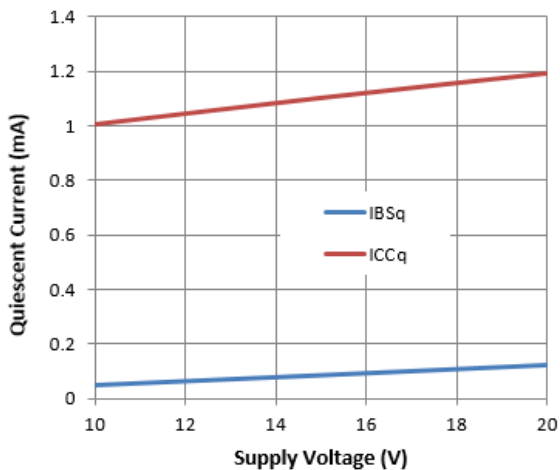

Figure 13. Quiescent Current vs. Supply Voltage

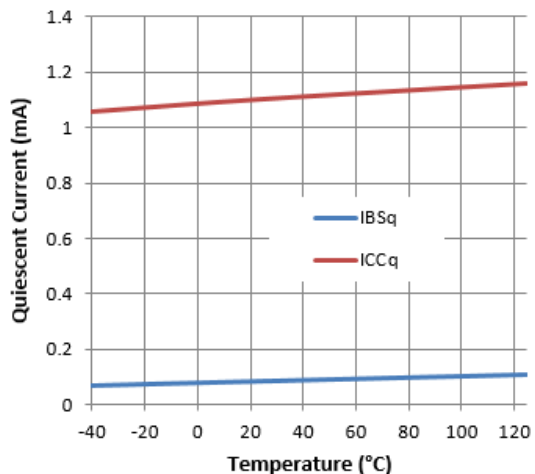

Figure 14. Quiescent Current vs. Temperature

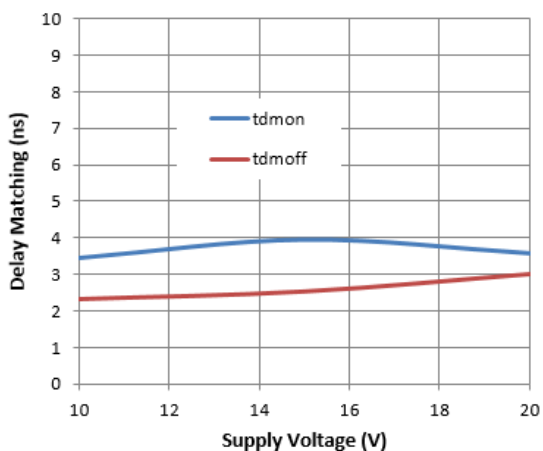

Figure 15. Delay Matching vs. Supply Voltage

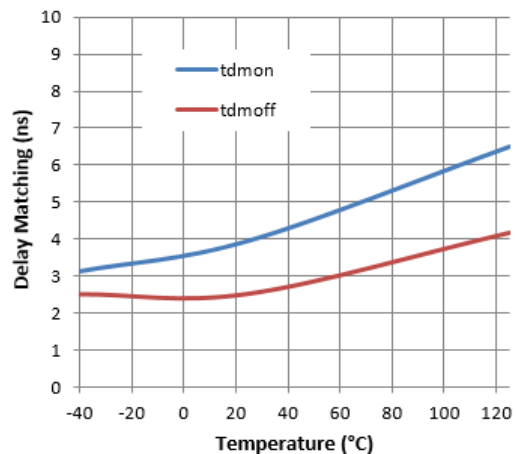

Figure 16. Delay Matching vs. Temperature

Typical Performance Characteristics (Cont.)

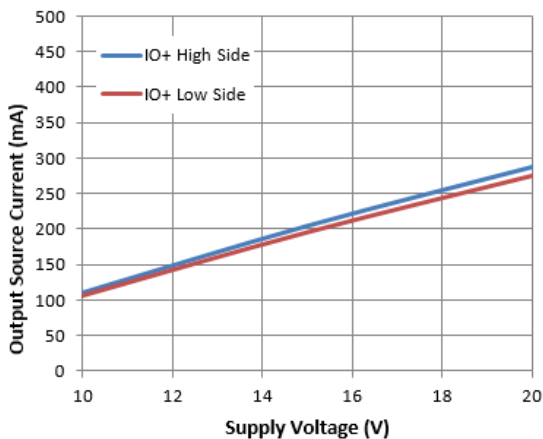

Figure 17. Output Source Current vs. Supply Voltage

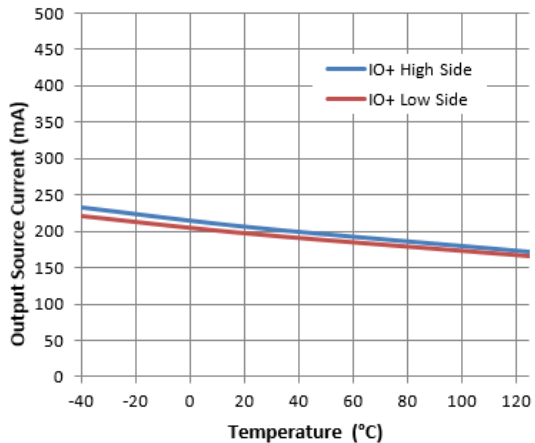

Figure 18. Output Source Current vs. Temperature

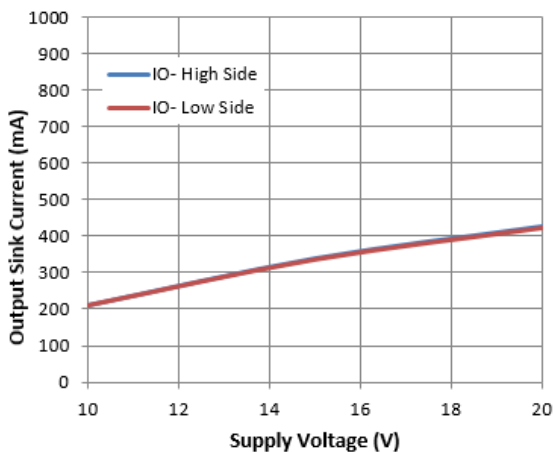

Figure 19. Output Sink Current vs. Supply Voltage

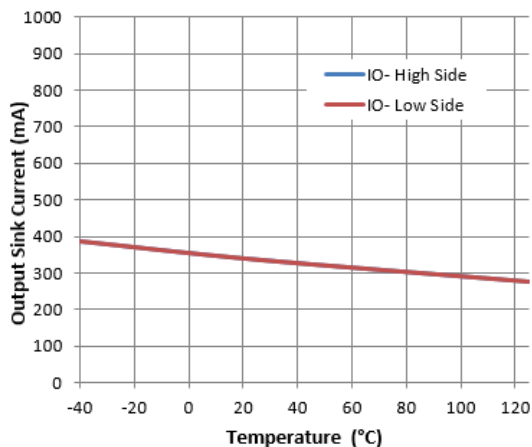

Figure 20. Output Sink Current vs. Temperature

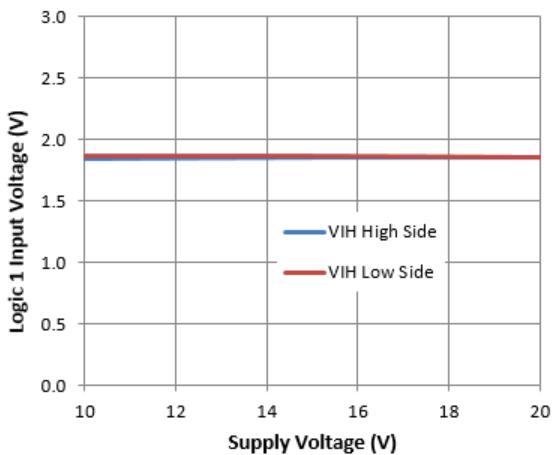

Figure 21. Logic 1 Input Voltage vs. Supply Voltage

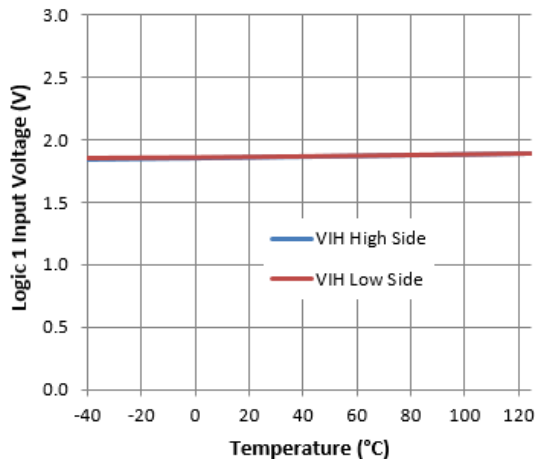

Figure 22. Logic 1 Input Voltage vs. Temperature

Typical Performance Characteristics (Cont.)

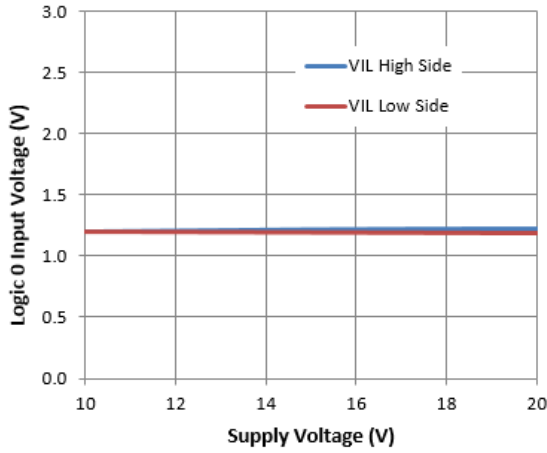

Figure 23. Logic 0 Input Voltage vs. Supply Voltage

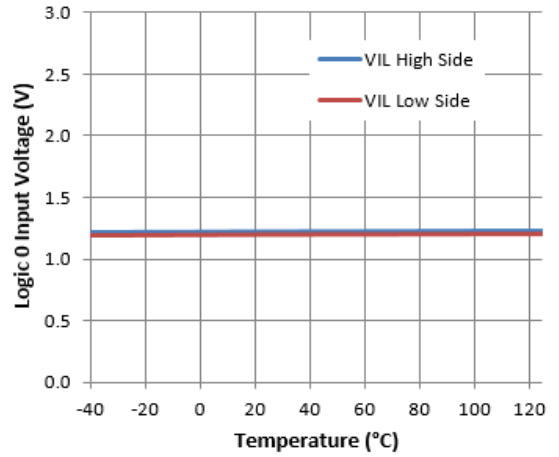

Figure 24. Logic 0 Input Voltage vs. Temperature

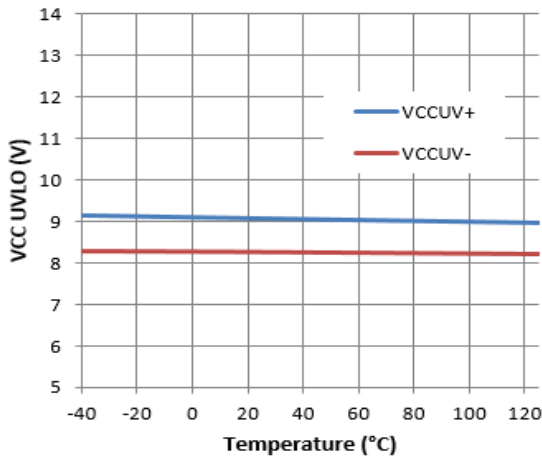

Figure 25. VCC UVLO vs. Temperature

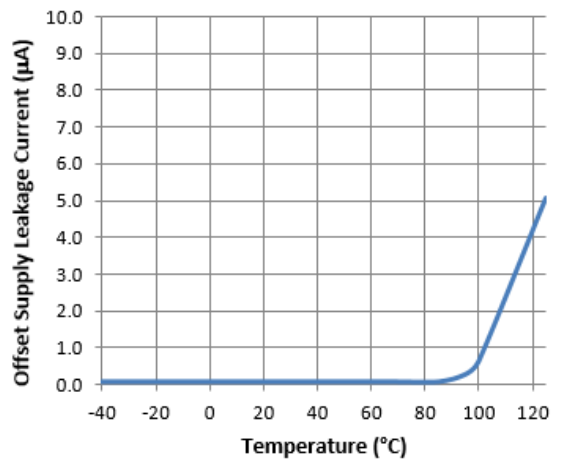
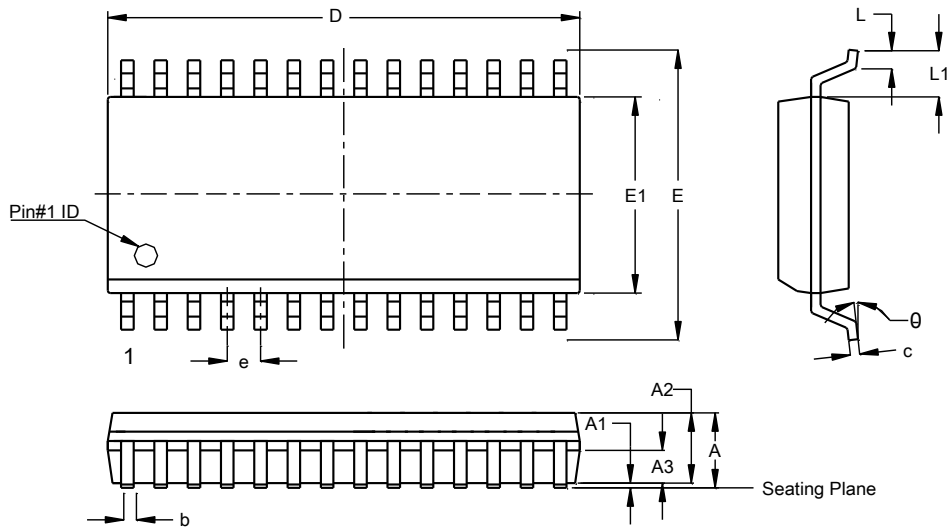

Figure 26. Offset Supply Leakage Current vs. Temperature

Package Outline Dimensions

Please see <http://www.diodes.com/package-outlines.html> for the latest version.

SO-28 (Type TH)



SO-28 (Type TH)			
Dim	Min	Max	Typ
A	--	2.65	--
A1	0.10	0.30	--
A2	2.25	2.35	2.30
A3	0.97	1.07	1.02
b	0.39	0.48	--
c	0.25	0.31	--
D	17.80	18.20	18.00
E	10.10	10.50	10.30
E1	7.30	7.70	7.50
e	1.27 BSC		
L	0.70	1.00	--
L1	1.40 BSC		
θ	0°	8°	--
All Dimensions in mm			

Suggested Pad Layout

Please see <http://www.diodes.com/package-outlines.html> for the latest version.

SO-28 (Type TH)

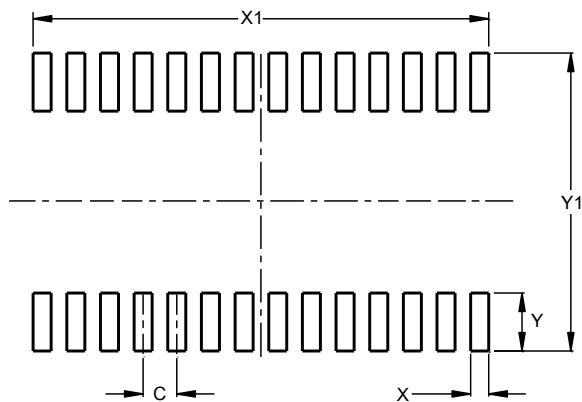

Dimensions	Value (in mm)
C	1.270
X	0.680
X1	17.190
Y	2.200
Y1	11.300

Note: For high voltage applications, the appropriate industry sector guidelines should be considered with regards to creepage and clearance distances between device Terminals and PCB tracking.

IMPORTANT NOTICE

DIODES INCORPORATED MAKES NO WARRANTY OF ANY KIND, EXPRESS OR IMPLIED, WITH REGARDS TO THIS DOCUMENT, INCLUDING, BUT NOT LIMITED TO, THE IMPLIED WARRANTIES OF MERCHANTABILITY AND FITNESS FOR A PARTICULAR PURPOSE (AND THEIR EQUIVALENTS UNDER THE LAWS OF ANY JURISDICTION).

Diodes Incorporated and its subsidiaries reserve the right to make modifications, enhancements, improvements, corrections or other changes without further notice to this document and any product described herein. Diodes Incorporated does not assume any liability arising out of the application or use of this document or any product described herein; neither does Diodes Incorporated convey any license under its patent or trademark rights, nor the rights of others. Any Customer or user of this document or products described herein in such applications shall assume all risks of such use and will agree to hold Diodes Incorporated and all the companies whose products are represented on Diodes Incorporated website, harmless against all damages.

Diodes Incorporated does not warrant or accept any liability whatsoever in respect of any products purchased through unauthorized sales channel. Should Customers purchase or use Diodes Incorporated products for any unintended or unauthorized application, Customers shall indemnify and hold Diodes Incorporated and its representatives harmless against all claims, damages, expenses, and attorney fees arising out of, directly or indirectly, any claim of personal injury or death associated with such unintended or unauthorized application.

Products described herein may be covered by one or more United States, international or foreign patents pending. Product names and markings noted herein may also be covered by one or more United States, international or foreign trademarks.

This document is written in English but may be translated into multiple languages for reference. Only the English version of this document is the final and determinative format released by Diodes Incorporated.

LIFE SUPPORT

Diodes Incorporated products are specifically not authorized for use as critical components in life support devices or systems without the express written approval of the Chief Executive Officer of Diodes Incorporated. As used herein:

A. Life support devices or systems are devices or systems which:

1. are intended to implant into the body, or
2. support or sustain life and whose failure to perform when properly used in accordance with instructions for use provided in the labeling can be reasonably expected to result in significant injury to the user.

B. A critical component is any component in a life support device or system whose failure to perform can be reasonably expected to cause the failure of the life support device or to affect its safety or effectiveness.

Customers represent that they have all necessary expertise in the safety and regulatory ramifications of their life support devices or systems, and acknowledge and agree that they are solely responsible for all legal, regulatory and safety-related requirements concerning their products and any use of Diodes Incorporated products in such safety-critical, life support devices or systems, notwithstanding any devices- or systems-related information or support that may be provided by Diodes Incorporated. Further, Customers must fully indemnify Diodes Incorporated and its representatives against any damages arising out of the use of Diodes Incorporated products in such safety-critical, life support devices or systems.

Copyright © 2017, Diodes Incorporated

www.diodes.com



Компания «ЭлектроПласт» предлагает заключение долгосрочных отношений при поставках импортных электронных компонентов на взаимовыгодных условиях!

Наши преимущества:

- Оперативные поставки широкого спектра электронных компонентов отечественного и импортного производства напрямую от производителей и с крупнейших мировых складов;
- Поставка более 17-ти миллионов наименований электронных компонентов;
- Поставка сложных, дефицитных, либо снятых с производства позиций;
- Оперативные сроки поставки под заказ (от 5 рабочих дней);
- Экспресс доставка в любую точку России;
- Техническая поддержка проекта, помощь в подборе аналогов, поставка прототипов;
- Система менеджмента качества сертифицирована по Международному стандарту ISO 9001;
- Лицензия ФСБ на осуществление работ с использованием сведений, составляющих государственную тайну;
- Поставка специализированных компонентов (Xilinx, Altera, Analog Devices, Intersil, Interpoint, Microsemi, Aeroflex, Peregrine, Syfer, Eurofarad, Texas Instrument, Miteq, Cobham, E2V, MA-COM, Hittite, Mini-Circuits, General Dynamics и др.);

Помимо этого, одним из направлений компании «ЭлектроПласт» является направление «Источники питания». Мы предлагаем Вам помощь Конструкторского отдела:

- Подбор оптимального решения, техническое обоснование при выборе компонента;
- Подбор аналогов;
- Консультации по применению компонента;
- Поставка образцов и прототипов;
- Техническая поддержка проекта;
- Защита от снятия компонента с производства.



Как с нами связаться

Телефон: 8 (812) 309 58 32 (многоканальный)

Факс: 8 (812) 320-02-42

Электронная почта: org@eplast1.ru

Адрес: 198099, г. Санкт-Петербург, ул. Калинина, дом 2, корпус 4, литера А.