

ZENER DIODE

FEATURES

Planar Die Construction

General Purpose, Medium Current

Ideally Suited for Automated Assembly

P/N suffix V means AEC-Q101qualified, e.g:MMBZ5221BV

P/N suffix V means Halogen-free

ESD Rating of Class 3 (>16 KV) per Human Body Model

SOT-23

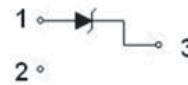
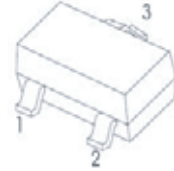

Maximum Ratings(T_a= 25°C unless otherwise specified)

| Characteristic | Symbol | Value | Unit |
|---|------------------|------------|------|
| Forward Voltage @ I _F = 10mA | V _F | 0.9 | V |
| Power Dissipation | P _D | 300 | mW |
| Thermal Resistance from Junction to Ambient | R _{θJA} | 417 | °C/W |
| Junction Temperature | T _j | -55 ~ +150 | °C |
| Storage Temperature Range | T _{stg} | -55 ~ +150 | °C |

Note: Replaced CMBZ52xxxB series.

2019-06
REV:C

ELECTRICAL CHARACTERISTICS $T_a=25^{\circ}\text{C}$ unless otherwise specified

| Type Number | Marking Code | Zener Voltage Range (Note 1) | | | Test Current | Maximum Zener Impedance (Note 2) | | Maximum Reverse Leakage Current (Note 1) | |
|-------------|--------------|------------------------------|---------|---------|--------------|----------------------------------|-----------------------------------|--|---------|
| | | $V_z @ I_{zT}$ | | | I_{zT} | $Z_{zT} @ I_{zT}$ | $Z_{zK} @ I_{zK} = 0.25\text{mA}$ | I_R | @ V_R |
| | | Nom (V) | Min (V) | Max (V) | mA | Ω | | μA | V |
| MMBZ5221B | KC1 | 2.4 | 2.28 | 2.52 | 20 | 30 | 1200 | 100 | 1.0 |
| MMBZ5222B | KC2 | 2.5 | 2.38 | 2.63 | 20 | 30 | 1250 | 100 | 1.0 |
| MMBZ5223B | KC3 | 2.7 | 2.57 | 2.84 | 20 | 30 | 1300 | 75 | 1.0 |
| MMBZ5225B | KC5 | 3.0 | 2.85 | 3.15 | 20 | 30 | 1600 | 50 | 1.0 |
| MMBZ5226B | KG1 | 3.3 | 3.14 | 3.47 | 20 | 28 | 1600 | 25 | 1.0 |
| MMBZ5227B | KG2 | 3.6 | 3.42 | 3.78 | 20 | 24 | 1700 | 15 | 1.0 |
| MMBZ5228B | KG3 | 3.9 | 3.71 | 4.10 | 20 | 23 | 1900 | 10 | 1.0 |
| MMBZ5229B | KG4 | 4.3 | 4.09 | 4.52 | 20 | 22 | 2000 | 5.0 | 1.0 |
| MMBZ5230B | KG5 | 4.7 | 4.47 | 4.94 | 20 | 19 | 1900 | 5.0 | 2.0 |
| MMBZ5231B | KE1 | 5.1 | 4.85 | 5.36 | 20 | 17 | 1600 | 5.0 | 2.0 |
| MMBZ5232B | KE2 | 5.6 | 5.32 | 5.88 | 20 | 11 | 1600 | 5.0 | 3.0 |
| MMBZ5233B | KE3 | 6.0 | 5.70 | 6.30 | 20 | 7 | 1600 | 5.0 | 3.5 |
| MMBZ5234B | KE4 | 6.2 | 5.89 | 6.51 | 20 | 7 | 1000 | 5.0 | 4.0 |
| MMBZ5235B | KE5 | 6.8 | 6.46 | 7.14 | 20 | 5 | 750 | 3.0 | 5.0 |
| MMBZ5236B | KF1 | 7.5 | 7.13 | 7.88 | 20 | 6 | 500 | 3.0 | 6.0 |
| MMBZ5237B | KF2 | 8.2 | 7.79 | 8.61 | 20 | 8 | 500 | 3.0 | 6.5 |
| MMBZ5238B | KF3 | 8.7 | 8.27 | 9.14 | 20 | 8 | 600 | 3.0 | 6.5 |
| MMBZ5239B | KF4 | 9.1 | 8.65 | 9.56 | 20 | 10 | 600 | 3.0 | 7.0 |
| MMBZ5240B | KF5 | 10 | 9.50 | 10.50 | 20 | 17 | 600 | 3.0 | 8.0 |
| MMBZ5241B | KH1 | 11 | 10.45 | 11.55 | 20 | 22 | 600 | 2.0 | 8.4 |
| MMBZ5242B | KH2 | 12 | 11.40 | 12.60 | 20 | 30 | 600 | 1.0 | 9.1 |
| MMBZ5243B | KH3 | 13 | 12.35 | 13.65 | 9.5 | 13 | 600 | 0.5 | 9.9 |
| MMBZ5244B | KH4 | 14 | 13.30 | 14.70 | 9.0 | 15 | 600 | 0.1 | 10 |
| MMBZ5245B | KH5 | 15 | 14.25 | 15.75 | 8.5 | 16 | 600 | 0.1 | 11 |
| MMBZ5246B | KJ1 | 16 | 15.20 | 16.80 | 7.8 | 17 | 600 | 0.1 | 12 |
| MMBZ5247B | KJ2 | 17 | 16.15 | 17.85 | 7.4 | 19 | 600 | 0.1 | 13 |
| MMBZ5248B | KJ3 | 18 | 17.10 | 18.90 | 7.0 | 21 | 600 | 0.1 | 14 |
| MMBZ5249B | KJ4 | 19 | 18.05 | 19.95 | 6.6 | 23 | 600 | 0.1 | 14 |
| MMBZ5250B | KJ5 | 20 | 19.00 | 21.00 | 6.2 | 25 | 600 | 0.1 | 15 |
| MMBZ5251B | KK1 | 22 | 20.90 | 23.10 | 5.6 | 29 | 600 | 0.1 | 17 |
| MMBZ5252B | KK2 | 24 | 22.80 | 25.20 | 5.2 | 33 | 600 | 0.1 | 18 |
| MMBZ5253B | KK3 | 25 | 23.75 | 26.25 | 5.0 | 35 | 600 | 0.1 | 19 |
| MMBZ5254B | KK4 | 27 | 25.65 | 28.35 | 5.0 | 41 | 600 | 0.1 | 21 |
| MMBZ5255B | KK5 | 28 | 26.60 | 29.40 | 4.5 | 44 | 600 | 0.1 | 21 |
| MMBZ5256B | KM1 | 30 | 28.50 | 31.50 | 4.2 | 49 | 600 | 0.1 | 23 |
| MMBZ5257B | KM2 | 33 | 31.35 | 34.65 | 3.8 | 58 | 700 | 0.1 | 25 |
| MMBZ5258B | KM3 | 36 | 34.20 | 37.80 | 3.4 | 70 | 700 | 0.1 | 27 |
| MMBZ5259B | KM4 | 39 | 37.05 | 40.95 | 3.2 | 80 | 800 | 0.1 | 30 |

Notes: 1. Short duration test pulse used to minimize self-heating effect.
2. $f = 1\text{kHz}$.

RATING AND CHARACTERISTICS CURVES (MMBZ5221B THRU MMBZ5259B)

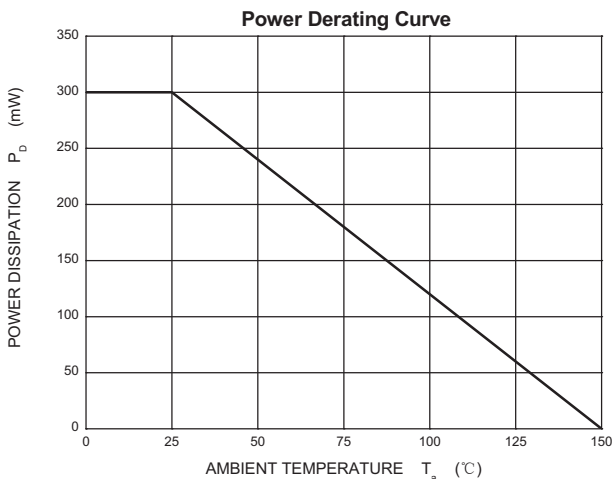
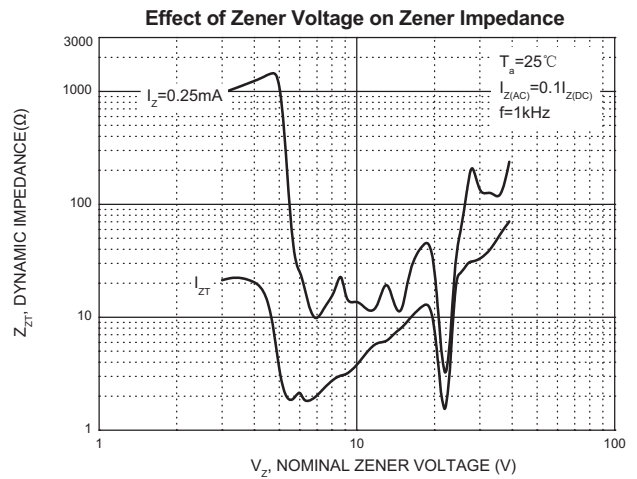
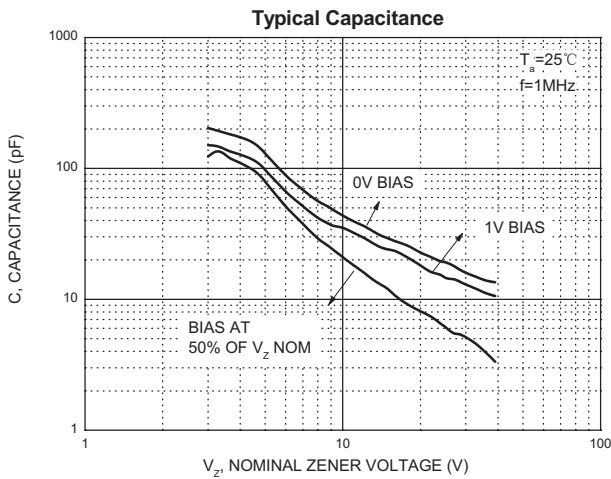
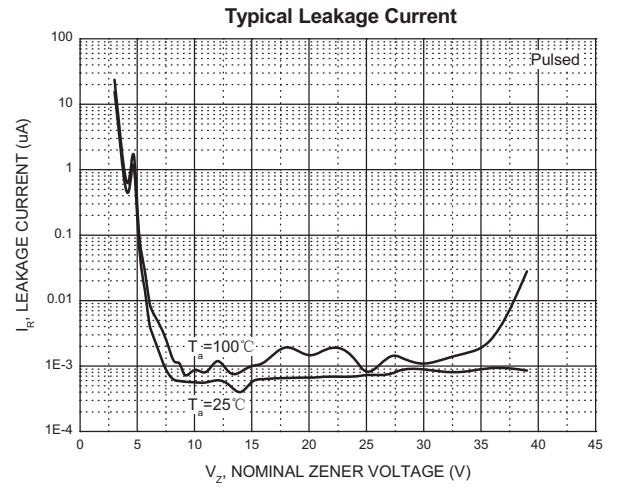
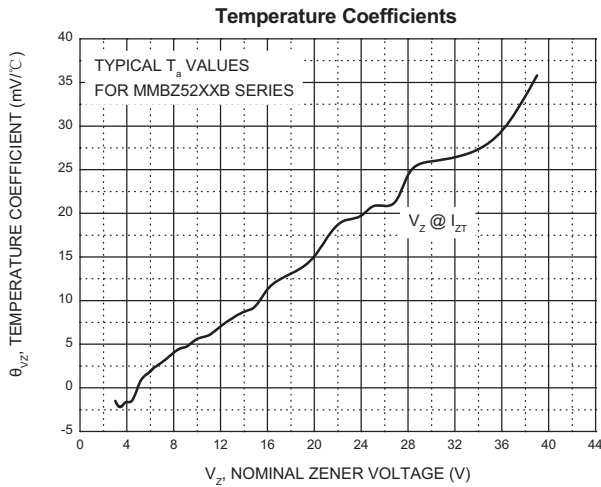
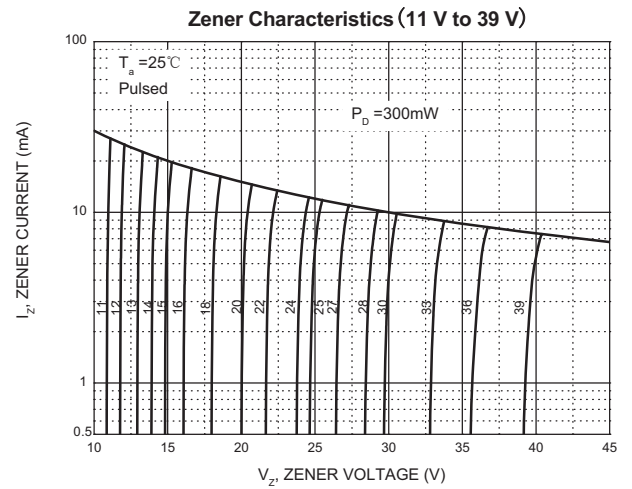
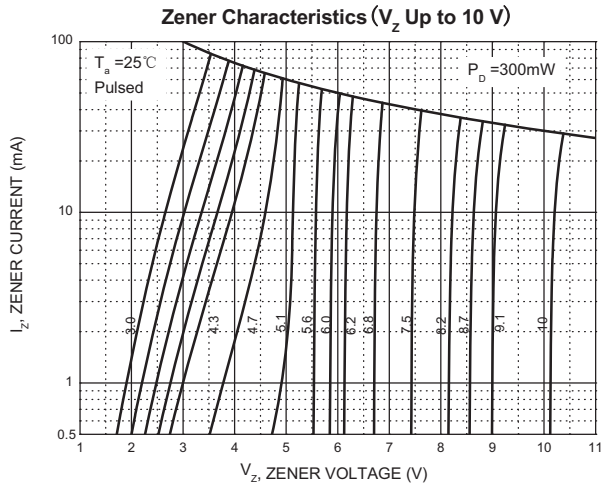

Notes: Our company currently provide 3.0V-39V products only

SOT-23 Package Outline Dimensions

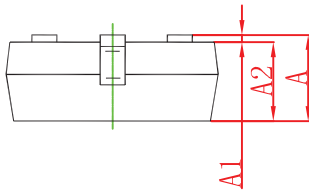
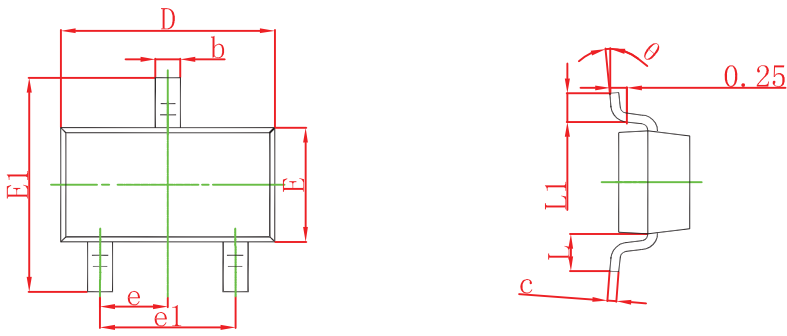

| Symbol | Dimensions In Millimeters | | Dimensions In Inches | |
|----------|---------------------------|-------|----------------------|-------|
| | Min | Max | Min | Max |
| A | 0.900 | 1.150 | 0.035 | 0.045 |
| A1 | 0.000 | 0.100 | 0.000 | 0.004 |
| A2 | 0.900 | 1.050 | 0.035 | 0.041 |
| b | 0.300 | 0.500 | 0.012 | 0.020 |
| c | 0.080 | 0.150 | 0.003 | 0.006 |
| D | 2.800 | 3.000 | 0.110 | 0.118 |
| E | 1.200 | 1.400 | 0.047 | 0.055 |
| E1 | 2.250 | 2.550 | 0.089 | 0.100 |
| e | 0.950 TYP | | 0.037 TYP | |
| e1 | 1.800 | 2.000 | 0.071 | 0.079 |
| L | 0.550 REF | | 0.022 REF | |
| L1 | 0.300 | 0.500 | 0.012 | 0.020 |
| θ | 0° | 8° | 0° | 8° |

SOT-23 Suggested Pad Layout

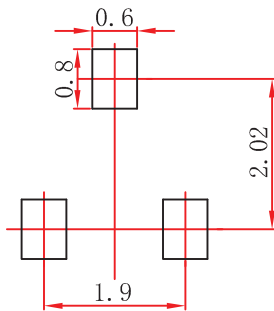

Note:

1. Controlling dimension; in millimeters.
2. General tolerance: $\pm 0.05\text{mm}$.
3. The pad layout is for reference purposes only.

SOT-23 Tape and Reel

SOT-23 Embossed Carrier Tape

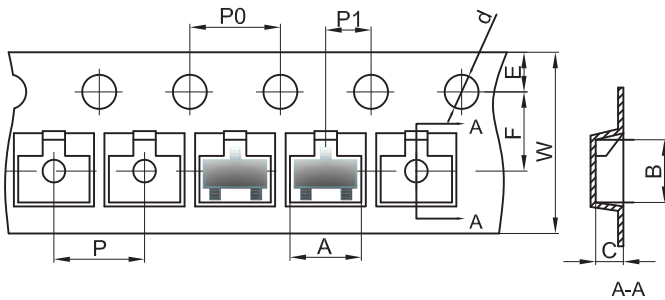

Packaging Description:

SOT-23 parts are shipped in tape. The carrier tape is made from a dissipative (carbon filled) polycarbonate resin. The cover tape is a multilayer film (Heat Activated Adhesive in nature) primarily composed of polyester film, adhesive layer, sealant, and anti-static sprayed agent. These reeled parts in standard option are shipped with 3,000 units per 7" or 17.8cm diameter reel. The reels are clear in color and is made of polystyrene plastic (anti-static coated).

Dimensions are in millimeter

| Pkg type | A | B | C | d | E | F | P0 | P | P1 | W |
|----------|------|------|------|-------|------|------|------|------|------|------|
| SOT-23 | 3.15 | 2.77 | 1.22 | Ø1.50 | 1.75 | 3.50 | 4.00 | 4.00 | 2.00 | 8.00 |

SOT-23 Tape Leader and Trailer

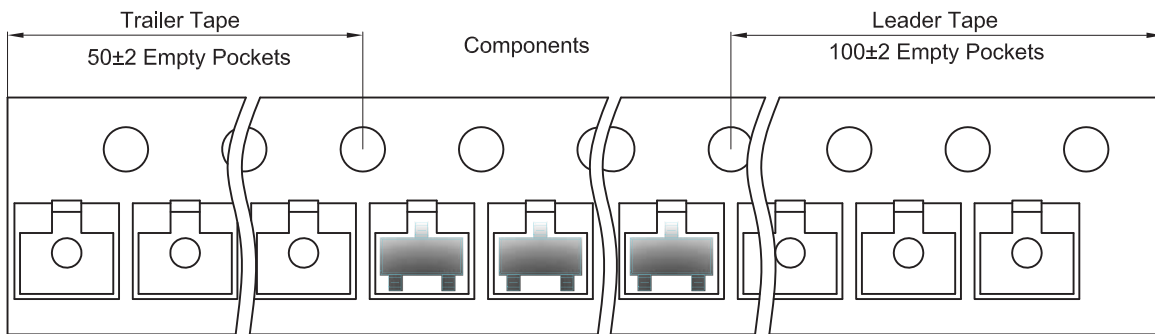

SOT-23 Reel

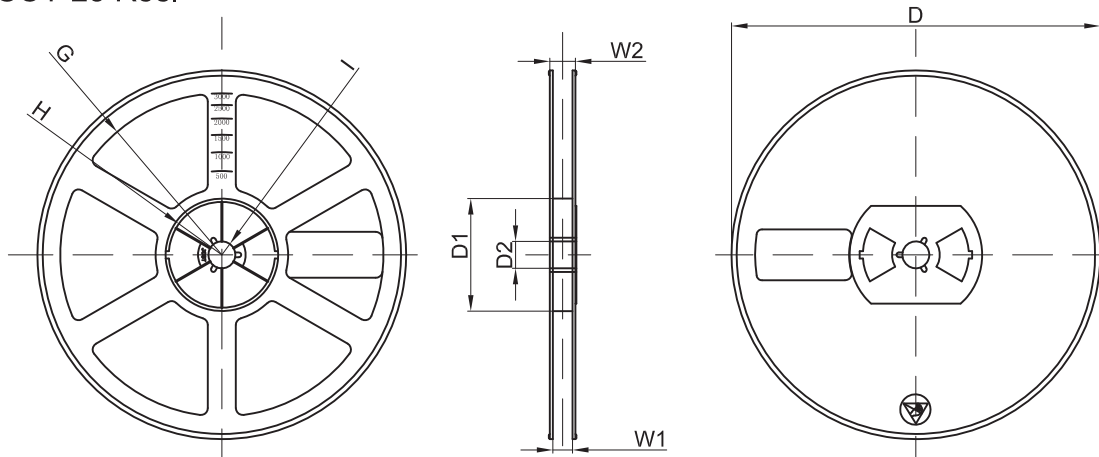

Dimensions are in millimeter

| Reel Option | D | D1 | D2 | G | H | I | W1 | W2 |
|-------------|---------|-------|-------|--------|--------|-------|------|-------|
| 7" Dia | Ø178.00 | 54.40 | 13.00 | R78.00 | R25.60 | R6.50 | 9.50 | 12.30 |

| REEL | Reel Size | Box | Box Size(mm) | Carton | Carton Size(mm) | G.W.(kg) |
|----------|-----------|------------|--------------|-------------|-----------------|----------|
| 3000 pcs | 7 inch | 45,000 pcs | 203×203×195 | 180,000 pcs | 438×438×220 | |



Компания «ЭлектроПласт» предлагает заключение долгосрочных отношений при поставках импортных электронных компонентов на взаимовыгодных условиях!

Наши преимущества:

- Оперативные поставки широкого спектра электронных компонентов отечественного и импортного производства напрямую от производителей и с крупнейших мировых складов;
- Поставка более 17-ти миллионов наименований электронных компонентов;
- Поставка сложных, дефицитных, либо снятых с производства позиций;
- Оперативные сроки поставки под заказ (от 5 рабочих дней);
- Экспресс доставка в любую точку России;
- Техническая поддержка проекта, помощь в подборе аналогов, поставка прототипов;
- Система менеджмента качества сертифицирована по Международному стандарту ISO 9001;
- Лицензия ФСБ на осуществление работ с использованием сведений, составляющих государственную тайну;
- Поставка специализированных компонентов (Xilinx, Altera, Analog Devices, Intersil, Interpoint, Microsemi, Aeroflex, Peregrine, Syfer, Eurofarad, Texas Instrument, Miteq, Cobham, E2V, MA-COM, Hittite, Mini-Circuits, General Dynamics и др.);

Помимо этого, одним из направлений компании «ЭлектроПласт» является направление «Источники питания». Мы предлагаем Вам помощь Конструкторского отдела:

- Подбор оптимального решения, техническое обоснование при выборе компонента;
- Подбор аналогов;
- Консультации по применению компонента;
- Поставка образцов и прототипов;
- Техническая поддержка проекта;
- Защита от снятия компонента с производства.



Как с нами связаться

Телефон: 8 (812) 309 58 32 (многоканальный)

Факс: 8 (812) 320-02-42

Электронная почта: org@eplast1.ru

Адрес: 198099, г. Санкт-Петербург, ул. Калинина, дом 2, корпус 4, литера А.