

# HCPL-354

## AC Input Phototransistor Optocoupler SMD Mini-Flat Type



### Data Sheet



#### Description

The HCPL-354 contains a phototransistor, optically coupled to two light emitting diodes connected inverse parallel. It can operate directly by AC input current. It is packaged in a 4-pin mini-flat SMD package with a 2.0 mm profile. The small dimension of this product allows significant space saving. The package volume is 30% smaller than that of conventional DIP type. Input-output isolation voltage is  $3750V_{rms}$ . Response time,  $t_r$ , is typically  $4\mu s$  and minimum CTR is 20% at input current of  $\pm 1$  mA.

#### Functional Diagram

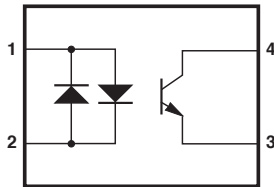

1. ANODE, CATHODE    3. EMITTER  
2. CATHODE, ANODE    4. COLLECTOR

#### Features

- AC input response
- Current transfer ratio (CTR: min. 20% at  $I_F = \pm 1$  mA,  $V_{CE} = 5$  V)
- Isolation voltage between input and output ( $V_{iso} = 3,750 V_{rms}$ )
- Subminiature type (The volume is smaller than that of conventional DIP type by as far as 30%)
- Mini-flat package
- 2.0 mm profile
- UL approved
- CSA approved
- IEC/EN/DIN EN 60747-5-2 approved
- Options available:
  - IEC/EN/DIN EN 60747-5-2 approvals (060)

#### Applications

- Detecting or monitoring AC signals
- Programmable controllers
- AC/DC-input modules
- AC line/digital logic isolation

**CAUTION:** It is advised that normal static precautions be taken in handling and assembly of this component to prevent damage and/or degradation which may be induced by ESD.

## Ordering Information

HCPL-354 is UL Recognized with 3750 Vrms for 1 minute per UL1577 and is approved under CSA Component Acceptance Notice #5, File CA 88324.

| Part Number | RoHS Compliant Option    |                          | Package | Surface Mount | Gull Wing | Tape & Reel | IEC/EN/DIN EN 60747-5-2 | Quantity          |
|-------------|--------------------------|--------------------------|---------|---------------|-----------|-------------|-------------------------|-------------------|
|             | Rank '0'<br>20%<CTR<400% | Rank 'A'<br>50%<CTR<150% |         |               |           |             |                         |                   |
| HCPL-354    | -000E                    | -00AE                    | S0-4    | X             |           | X           |                         | 3000 pcs per reel |
|             | -060E                    | -06AE                    | S0-4    | X             |           | X           | X                       | 3000 pcs per reel |

To order, choose a part number from the part number column and combine with the desired option from the option column to form an order entry.

Example 1:

HCPL-354-00AE to order product of Miniflat-4 AC Surface Mount package in Tape and Reel packaging with 50%<CTR<150% and RoHS compliant.

Example 2:

HCPL-354-060E to order product of Miniflat-4 AC Surface Mount package in Tape and Reel packaging with 20%<CTR<400%, IEC/EN/DIN EN60747-5-2 Safety Approval and RoHS compliant.

Option datasheets are available. Contact your Avago sales representative or authorized distributor for information.

## Package Outline Drawing

### HCPL-354-000E

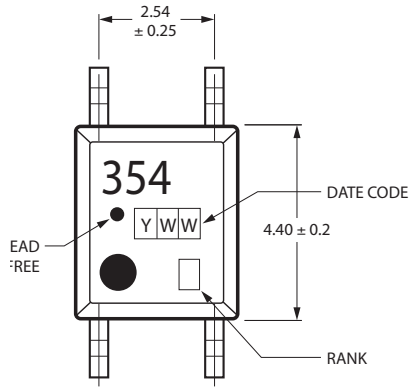

DIMENSIONS IN MILLIMETERS.

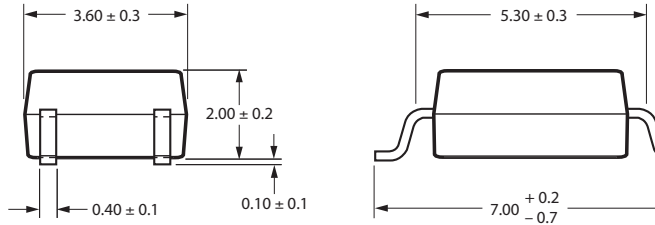

### HCPL-354-060E

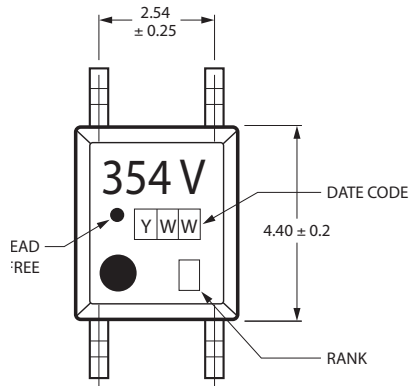

DIMENSIONS IN MILLIMETERS.

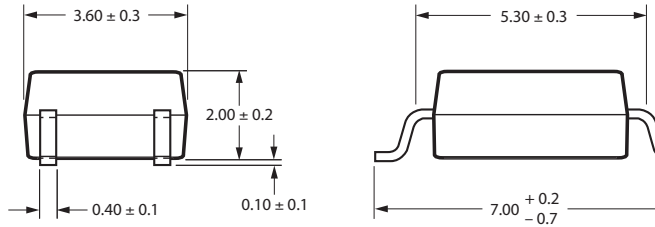

## Solder Reflow Temperature Profile

- 1) One-time soldering reflow is recommended within the condition of temperature and time profile shown at right.
- 2) When using another soldering method such as infrared ray lamp, the temperature may rise partially in the mold of the device. Keep the temperature on the package of the device within the condition of (1) above.

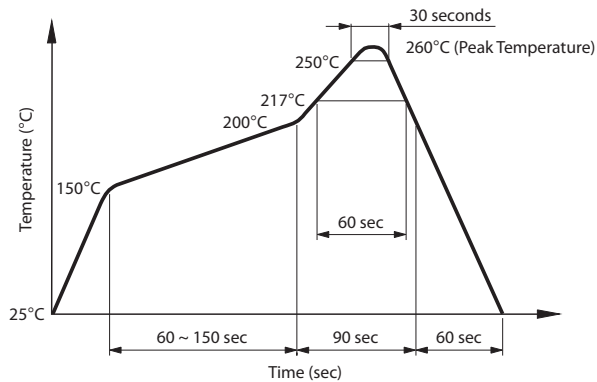

**Note: Non-halide flux should be used.**

## Absolute Maximum Ratings

| Parameters   | Symbol    | Min. | Max. | Units     |
|--|-----------|------|------|-----------|
| Storage Temperature  | $T_S$     | -55  | 150  | °C        |
| Ambient Operating Temperature  | $T_A$     | -55  | 100  | °C        |
| Lead Solder Temperature for 10s<br>(1.6 mm below seating plane)        | $T_{sol}$ |      | 260  | °C        |
| Average Forward Current  | $I_F$     |      | ±50  | mA        |
| Input Power Dissipation  | $P_I$     |      | 70   | mW        |
| Collector Current  | $I_C$     |      | 50   | mA        |
| Collector-Emitter Voltage  | $V_{CE0}$ |      | 35   | V         |
| Emitter-Collector Voltage  | $V_{ECO}$ |      | 6    | V         |
| Collector Power Dissipation  | $P_C$     |      | 150  | mW        |
| Total Power Dissipation  | $P_{tot}$ |      | 170  | mW        |
| Isolation Voltage<br>(AC for 1 minute, R.H. = 40 ~ 60%) <sup>[1]</sup> | $V_{iso}$ |      | 3750 | $V_{rms}$ |

## Electrical Specifications ( $T_A = 25^\circ\text{C}$ )

| Parameter                             | Symbol        | Min.               | Typ.               | Max. | Units         | Test Conditions                             |
|---------------------------------------|---------------|--------------------|--------------------|------|---------------|---|
| Forward Voltage                       | $V_F$         | –                  | 1.2                | 1.4  | V             | $I_F = \pm 20\text{ mA}$                    |
| Terminal Capacitance                  | $C_t$         | –                  | 30                 | 250  | pF            | $V = 0, f = 1\text{ kHz}$                   |
| Collector Dark Current                | $I_{CE0}$     | –                  | –                  | 100  | nA            | $V_{CE} = 20\text{ V}, I_F = 0$             |
| Collector-Emitter Breakdown Voltage   | $BV_{CE0}$    | 35                 | –                  | –    | V             | $I_C = 0.1\text{ mA}, I_F = 0$              |
| Emitter-Collector Breakdown Voltage   | $BV_{ECO}$    | 6                  | –                  | –    | V             | $I_E = 10\text{ }\mu\text{A}, I_F = 0$      |
| Collector Current                     | $I_C$         | 0.2                | –                  | 4    | mA            | $I_F = \pm 1\text{ mA}$ ,                   |
| Current Transfer Ratio <sup>[2]</sup> | CTR           | 20                 | –                  | 400  | %             | $V_{CE} = 5\text{ V}$                       |
| Collector-Emitter Saturation Voltage  | $V_{CE(sat)}$ | –                  | 0.1                | 0.2  | V             | $I_F = \pm 20\text{ mA}, I_C = 1\text{ mA}$ |
| Isolation Resistance                  | $R_{iso}$     | $5 \times 10^{10}$ | $1 \times 10^{11}$ | –    | $\Omega$      | DC 500 V<br>40 ~ 60% R.H.                   |
| Floating Capacitance                  | $C_f$         | –                  | 0.6                | 1    | pF            | $V = 0, f = 1\text{ MHz}$                   |
| Response Time (Rise)                  | $t_r$         | –                  | 4                  | 18   | $\mu\text{s}$ | $V_{CE} = 2\text{ V}, I_C = 2\text{ mA}$ ,  |
| Response Time (Fall)                  | $t_f$         | –                  | 3                  | 18   | $\mu\text{s}$ | $R_L = 100\text{ }\Omega$                   |

| Rank Mark | CTR (%)  | Conditions                |
|-----------|----------|---------------------------|
| A         | 50 ~ 150 | $I_F = \pm 1\text{ mA}$ , |
| No Mark   | 20 ~ 400 | $V_{CE} = 5\text{ V}$ ,   |
|           |          | $T_A = 25^\circ\text{C}$  |

### Notes:

- Isolation voltage shall be measured using the following method:
  - Short between anode and cathode on the primary side and between collector and emitter on the secondary side.
  - The isolation voltage tester with zero-cross circuit shall be used.
  - The waveform of applied voltage shall be a sine wave.

$$2. \text{ CTR} = \frac{I_C}{I_F} \times 100\%$$

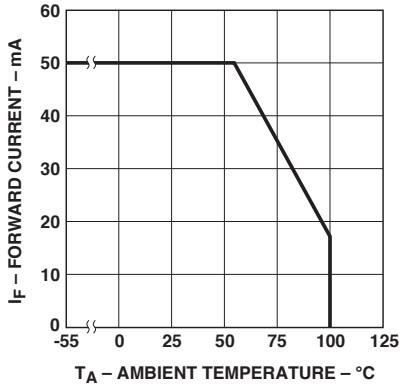

Figure 1. Forward current vs. ambient temperature.

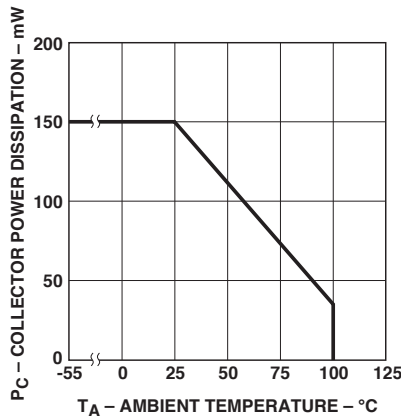

Figure 2. Collector power dissipation vs. ambient temperature.

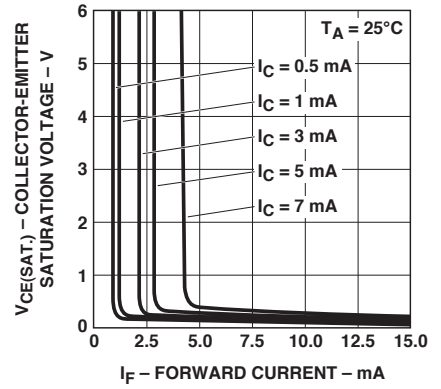

Figure 3. Collector-emitter saturation voltage vs. forward current.

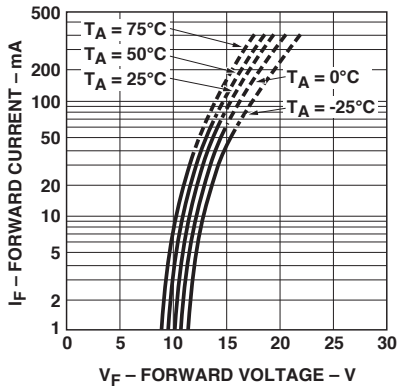

Figure 4. Forward current vs. forward voltage.

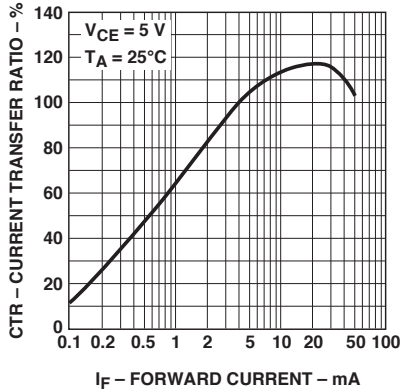

Figure 5. Current transfer ratio vs. forward current.

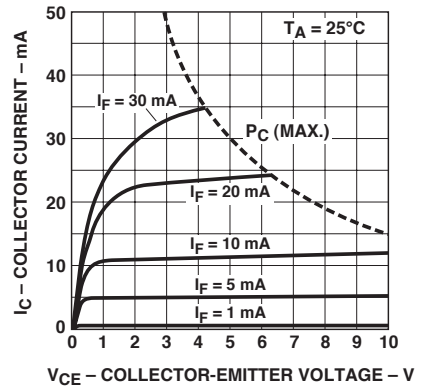

Figure 6. Collector current vs. collector-emitter voltage.

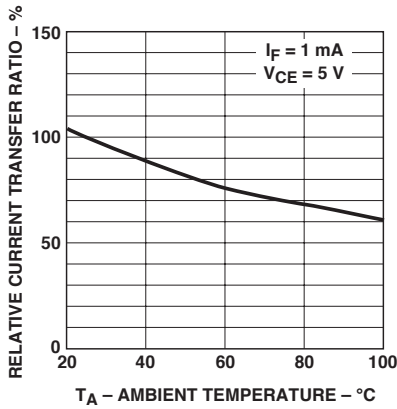

Figure 7. Relative current transfer ratio vs. ambient temperature.

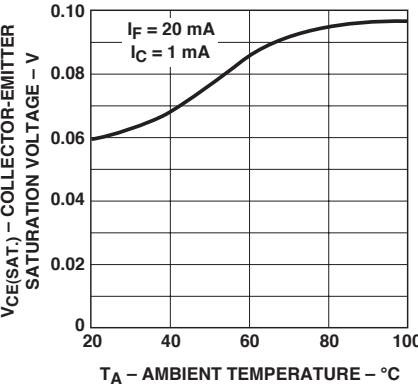

Figure 8. Collector-emitter saturation voltage vs. ambient temperature.

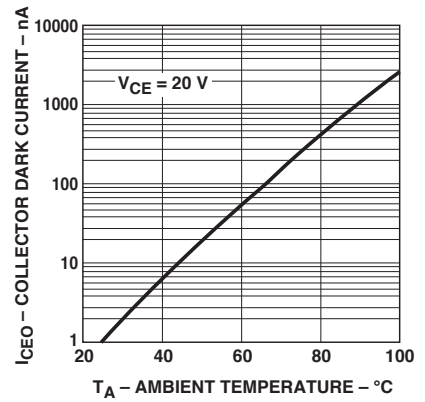

Figure 9. Collector dark current vs. ambient temperature.

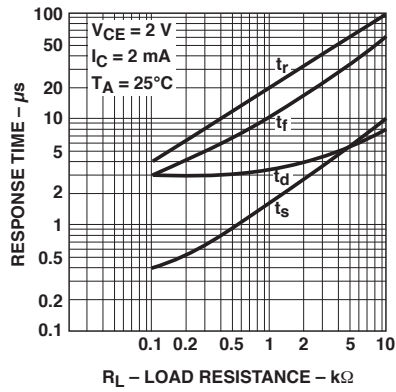

Figure 10. Response time vs. load resistance.

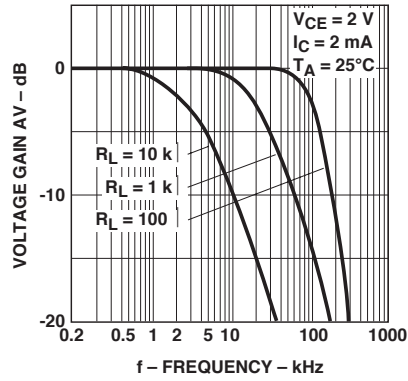

Figure 11. Frequency response.

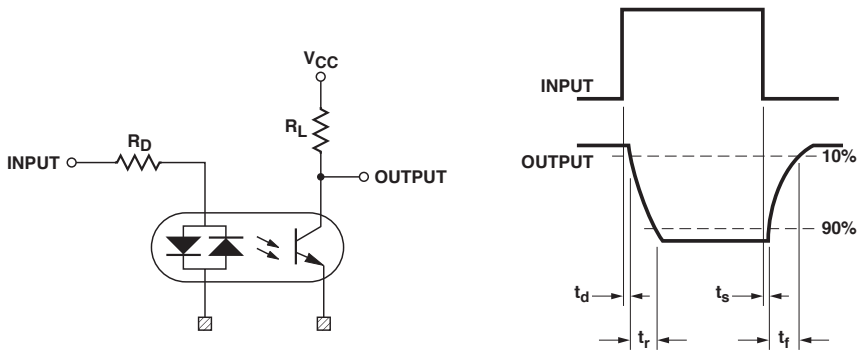

Figure 12. Test circuit for response time.

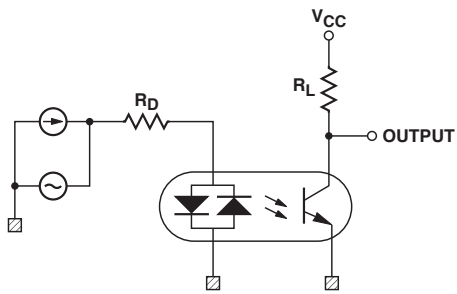

Figure 13. Test circuit for frequency response.

For product information and a complete list of distributors, please go to our web site: [www.avagotech.com](http://www.avagotech.com)

Avago, Avago Technologies, and the A logo are trademarks of Avago Technologies, Limited in the United States and other countries. Data subject to change. Copyright © 2007 Avago Technologies Limited. All rights reserved. AV02-0775EN - October 18, 2007





Компания «ЭлектроПласт» предлагает заключение долгосрочных отношений при поставках импортных электронных компонентов на взаимовыгодных условиях!

Наши преимущества:

- Оперативные поставки широкого спектра электронных компонентов отечественного и импортного производства напрямую от производителей и с крупнейших мировых складов;
- Поставка более 17-ти миллионов наименований электронных компонентов;
- Поставка сложных, дефицитных, либо снятых с производства позиций;
- Оперативные сроки поставки под заказ (от 5 рабочих дней);
- Экспресс доставка в любую точку России;
- Техническая поддержка проекта, помощь в подборе аналогов, поставка прототипов;
- Система менеджмента качества сертифицирована по Международному стандарту ISO 9001;
- Лицензия ФСБ на осуществление работ с использованием сведений, составляющих государственную тайну;
- Поставка специализированных компонентов (Xilinx, Altera, Analog Devices, Intersil, Interpoint, Microsemi, Aeroflex, Peregrine, Syfer, Eurofarad, Texas Instrument, Miteq, Cobham, E2V, MA-COM, Hittite, Mini-Circuits, General Dynamics и др.);

Помимо этого, одним из направлений компании «ЭлектроПласт» является направление «Источники питания». Мы предлагаем Вам помощь Конструкторского отдела:

- Подбор оптимального решения, техническое обоснование при выборе компонента;
- Подбор аналогов;
- Консультации по применению компонента;
- Поставка образцов и прототипов;
- Техническая поддержка проекта;
- Защита от снятия компонента с производства.



#### Как с нами связаться

**Телефон:** 8 (812) 309 58 32 (многоканальный)

**Факс:** 8 (812) 320-02-42

**Электронная почта:** [org@eplast1.ru](mailto:org@eplast1.ru)

**Адрес:** 198099, г. Санкт-Петербург, ул. Калинина, дом 2, корпус 4, литера А.