

Powerpole® Connectors - PP75: up to 120 Amps



PP75 series Powerpole® housings can be used for wire-to-wire, wire-to-board, and wire-to-busbar applications. Wire sizes from #16 AWG (1.3 mm²) to #6 (13.3 mm²) offer power capabilities up to 120 amps per pole. Locking housings offer the capability to secure Powerpole® housings to each other and to mounting pads. Housings made from chemical resistant (CR) resin withstand industrial solvents better than standard housings.

- **Large Wire Range Accommodates up to #6 (10mm²) Wire**
Reducing bushings allow as small as #16 (1.5 mm²) wire to be used
- **Wire, PCB, and Busbar Contacts**
Allows one connection system to meet multiple needs
- **Mini-Powerclaw PCB Contacts Minimize PCB Footprint**
Removes the PP75 housing from the board side

PP75 ORDERING INFORMATION |

PP75 Standard Housings

The second smallest Powerpole® housing can be used with wire contacts for up to 6 AWG [10mm²] as well as PCB and busbar contacts.

Description	----- Part Numbers -----	
Minimum Quantity ...	1,000	100
Red	5916G7-BK	5916G7
Green	5916G6-BK	5916G6
Black	5916G4-BK	5916G4
White	5916G5-BK	5916G5
Blue	5916-BK	5916
Yellow	5916G15-BK	5916G15
Orange	5916G14-BK	5916G14
Gray	5916G16-BK	5916G16

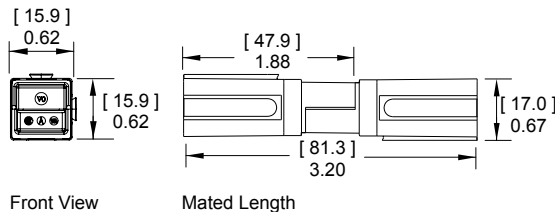

PP75 Chemical Resistant (CR) Housings

Has the same form and dimensions of the standard PP75 housing in a chemical resistant PBT/ PC blend housing. Suitable for use to -40°C.

Description	- Part Numbers -	
Minimum Quantity ...	1,000
Red	P5916G7-BK	
Black	P5916G4-BK	
White	P5916G5-BK	
Blue	P5916-BK	

Material ID Located Here
V0 = Standard
P = Chemical Resistant



PP75 Locking Dovetail Housings

Offers dovetails for stacking housings that have a locking feature to prevent housings separating. Can mate to standard and chemical resistant housings, but cannot be stacked with them.

Description	----- Part Numbers -----	
Minimum Quantity ...	1,000	100
Red	75LOKRED-BK	75LOKRED
Green	75LOKGRN-BK	75LOKGRN
Black	75LOKBLK-BK	75LOKBLK
White	75LOKWHT-BK	75LOKWHT
Blue	75LOKBLU-BK	75LOKBLU
Gray	75LOKGRA-BK	75LOKGRA

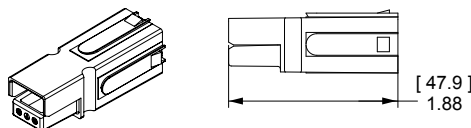



PP75 Premate Ground Housings

Offers a first-mate, last-break connection when stacked together with PP75 housings. Stacks together with PP75 standard and chemical resistant housings. Housings are mechanically keyed to prevent cross mating with power positions.



Description	----- Part Numbers -----	
Minimum Quantity...	1,000	100 ...
Green	5927G6-BK	5927G6

PP75 Silver Plated Wire Contacts

Silver plated contacts offer the best electrical performance and durability up to 10,000 mating cycles. See reducing bushings in accessory section for smaller wires.

AWG	mm ²	Mating Force	Loose Piece		Dimensions - A -	
			-- Part Numbers --		inches	mm
Minimum Quantity			1,000	100		
6	13.3	Low	1307-BK	1307	0.22	5.59
6	13.3	High	5900-BK	5900	0.22	5.59
8	8.4	High	5952-BK	5952	0.19	4.83
12 to 10	3.3 to 5.3	Low	5953-BK	5953	0.14	3.56
12 to 10	3.3 to 5.3	High	5915-BK	5915	0.14	3.56



PP75 Premate Ground Wire Contacts

Silver plated contacts for use with the PP75 Premate Ground Housing. Rated to 10,000 mating cycles.

Type	AWG	mm ²	Loose Piece		Dimensions - A -	
			----- Part Numbers -----		inches	mm
Minimum Quantity			1,000	100		
Individual	6	13.3	1875G1-BK	1875G1	0.22	5.59
Individual	8	8.4	1875G2-BK	1875G2	0.19	4.83
Individual	12 to 10	3.3 to 5.3	1875G3-BK	1875G3	0.14	3.56



PP75 Silver Plated Busbar Contacts

Provide a quick disconnect input or output busbar connection. Busbar contacts are for mating with wire contacts only. Part number 75BBS includes lock nuts. Locknuts must be ordered separately for B01915P1.

Type	Thread	Mating Force	----- Part Numbers -----		
Minimum Quantity			1,000	20	10 ...
Busbar	#10-24	High	B01915P1	-	75BBS
Lock Nut	#10-24	-	H1216P8	110G54	-



55A Right Angle Standard Powerclaw PCB Contacts

Standard Powerclaw contacts are for use inside a PP75 housing and provide a color coded right angle connection to the PCB.

Description	--- Loose Piece Part Numbers ---	
Minimum Quantity	500	100
Tin Plated	PC5930T-BK	PC5930T
Silver Plated	PC5930S-BK	PC5930S



See PCB contact drawing on website for further detail.

Second housing and contact in two pole version only.

55A Right Angle Mini Powerclaw PCB Contacts

Right angle Mini Powerclaw contacts can be used on the PCB edge without a PP75 housing on the PCB side. A self polarizing design only allow PP75 wire housings to mate to PCB contacts one way.

Description	Loose Piece	
	----- Part Numbers -----	
Minimum Quantity ...	1,000	100
Tin Plated	PC5934T-BK	PC5934T
Silver Plated	PC5934S-BK	PC5934S

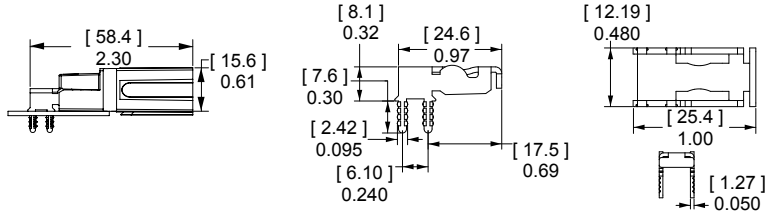

55A Vertical Mini Powerclaw PCB Contacts

Vertical Mini Powerclaw contacts save space by not requiring a PP75 housing on the PCB side. The guide housing is required for 2 pole applications to provide a polarized connection. (See PP75 accessories).

Description	Loose Piece	
	----- Part Numbers -----	
Minimum Quantity ...	1,500	100
Tin Plated	PC5933T-BK	PC5933T
Silver Plated	PC5933S-BK	PC5933S



See PCB contact drawing on website for further detail.

PP75 TEMPERATURE CHARTS



NOTE: Temperature rise charts are based on a 25°C ambient temperature. Powerclaw charts are based on #8 AWG equivalent copper foil on board side, mated to #6 AWG conductor on wire side.

PP75 SPECIFICATIONS |

Electrical		
Current Rating Amperes¹	UL 1977	CSA
Wire to Wire (6 AWG)	120	70
Wire to PCB (6-AWG)	55	50
Wire to Busbar (6 AWG)	75	
Voltage Rating AC/DC		
UL 1977	600	
PCB Connector Recommended Voltage³		
per IEC 60950-1 Table 2L Pollution Degree²		
Mini Vert. Contact Adjacent Poles	220	
Mini Horiz. Contact Adjacent Poles	200	
Standard Contact Adjacent Poles	635	
Dielectric Withstanding Voltage		
Volts AC	2,200	
Avg. Mated Contact Resistance Milliohms¹		
Wire Contact with 1 1/4" of #6 AWG	0.200	
PCB Contact to Contact	0.500	
UL Hot Plug Current Rating Amperes - 250 cycles at 120V DC		
Wire- wire	50A	
PCB- wire (Vertical Mini Powerclaw)	40A	
UL Ground Short Time Current Test - 75A Premate Ground		
1530 Amps, #6 AWG Wire	6 Seconds	

Materials	
Housing	
Standard Plastic Resin	Polycarbonate
Chem. Resistant Resin	Polycarbonate / PBT blend
Contact Retention Spring	Stainless Steel
Housing Flammability Rating	
UL94	V-0
Contact	
Base	Copper Alloy
Wire Plating	Silver
PCB Plating	Sn or Ag over Ni
Contact Termination Methods	
Crimp ⁴	Wire Contacts
Hand Solder	Wire and PCB Contacts
Solder Dip ⁴	PCB Contacts
Wave Solder ⁴	PCB Contacts
Wrench / Socket	Busbar Contacts

Mechanical		
Wire Size Range	AWG	mm²
Wire Contacts with Bushings	16 to 6	1.3 to 13.3
Max. Wire Insulation Diameter	in.	mm
	0.437	11.100
Operating Temperature²	°F	°C
Standard & Ground	-4° to 221°	-20° to 105°
Chemical Resistant [*]	-40 to 221°	-40° to 105°
*Chemical resistant material not available for PCB guide housings		
Mating Cycles No Load by Plating	Silver (Ag)	Tin (Sn)
Wire and PCB Contacts	10,000	1,500
Avg. Mating / Unmating Force	Lbf.	N
Wire to Wire Low Force Contacts	5	22
Wire to Wire High Force Contacts	7	31
Standard Powerclaw to Wire	7	31
Mini Powerclaw to Wire	4	17
PCB Specifications		
Mounting Style	Plated Through Hole	
Max PCB Thickness- in. [mm]	Standard: 0.15 [0.381]	
	Mini: 0.25 [0.635]	
Recommended Traces	#8 AWG Cross Section	
Min. Contact / Spring Retention Force	Lbf.	N
Wire Housing	50	222
Min. Creepage / Clearance Distance PCB in.		mm
Standard Powerclaw Adjacent Poles	0.260	6.6
Mini Vert. Powerclaw Adjacent Poles	0.087	2.2
Mini Horiz. Powerclaw Adjacent Poles	0.079	2.0
Mechanical Shock⁵		
MIL-STD-202	213 Condition A	50g's
Vibration High Frequency⁵		
MIL-STD-202	204 Condition A	10g's

Protection	
Touch Safety with Wire Contacts	
IEC 60529	IP10

¹ Based on: 105°C rated or better cable of the largest size, Properly calibrated APP® recommended tooling, and a 25°C ambient temperature. UL rating not to exceed the maximum operating temperature. CSA rating below a 30°C temperature rise.

² Limited by the thermal properties of the connector plastic housing.

³ Without use of spacers to increase creepage and clearance distances.

⁴ Use APP® recommended tooling only. Alternate tools may adversely affect the performance of our connectors along with UL and CSA recognition.

⁵ Tested with contact part number 5900.



| Powerpole® PP75 Accessories |

Strain Relief Grommets

Use for strain relief in the back side of a PP75 housing. Wire gauge given for reference only, use grommet ID and wire OD to determine suitability in the end application.

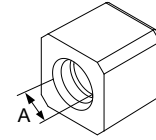

Description	- Part Numbers -	Dimensions - A - inches mm	
Minimum Quantity ...	100	
#6 AWG, Black	114411P2	0.35	8.89
#8 AWG, Black	114411P1	0.25	6.35
#10 - 12 AWG, Black	114411P3	0.17	4.32

Mounting Wing for Standard or CR Housings

Mounting wings can be used to secure dovetailed Powerpole® 75 series housings by passing fasteners through the wings in either a horizontal or vertical orientation. Useful for sheet metal panels, printed circuit boards, and many other mounting surfaces. Fasteners not included.



Description	----- Part Numbers -----	
Minimum Quantity ...	1,000	100 ...
Blue, Round Hole	1399G20-BK	1399G20
Blue, Oval Hole	1399G7-BK	1399G7

Mounting Wing for Locking Housings

Mounting wings can be used to secure Powerpole® 75 series housings with locking dovetails by passing fasteners through the wings in either a horizontal or vertical orientation. Useful for sheet metal panels, printed circuit boards, and many other mounting surfaces. Fasteners not included.

Description	----- Part Numbers -----	
Minimum Quantity ...	1,000	100 ...
Blue, Oval Hole	75LOKWNGBLU-BK	75LOKWNGBLU
Blue, Round Hole	75LOKWNGBLU-R-BK	75LOKWNGBLU-R

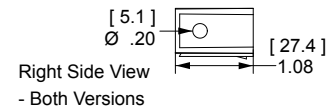
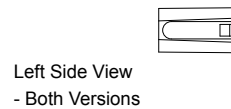

Surface Mount for Locking Housings

Use to secure Powerpole® 75 series housings with locking dovetails to a flat surface. Useful for sheet metal panels, printed circuit boards, and many other mounting surfaces. Fasteners not included.

Description	----- Part Numbers -----	
Minimum Quantity ...	1,000	100 ...
Blue	75LOKSMTBLU-BK	75LOKSMTBLU

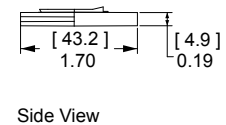
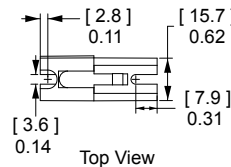

NEW Spacer

Use to separate housings under high power to minimize power capability derating due to heat rise. They are recommended for squaring off a block of Powerpole® 75 housings to enable mounting accessories or retaining pins to be used. Combining long and short spacers opposite each other in a mated block adds keying features, or use two short spacers to avoid interference.

Description	----- Part Numbers -----	
Minimum Quantity...	1000	100
Red, Short	1399G23-BK	1399G23
Red, Long	1399G21-BK	1399G21

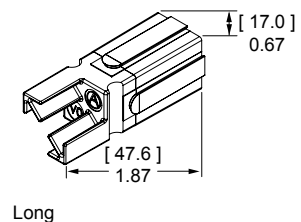
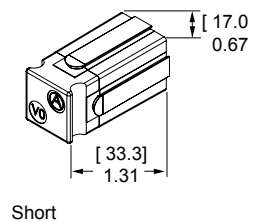

Guide Housings for Vertical Mini Powerclaw Contacts

Prevents polarity being reversed when a two pole PP75 block is mated to vertical mini Powerclaw contacts. Fastening hardware not included.

Description	Part Numbers	
Minimum Quantity ...	1,000	100 ...
Black Guide Housing	PC-HSG-PP-BK	PC-HSG-PP



Mounting Clamp

Mounting clamps can be used for fastening a block of Powerpole® 75 series housings to a panel. Connector blocks must be a complete square for the clamps to work properly. Fastening hardware not included.

Description	Part Numbers	
Minimum Quantity ...	50 sets of 2 ...	
2 or 4 Pole	1463G1	
3 or 6 Pole	1463G2	



Retaining Pins

Retaining pins are used to keep stacked Powerpole® 75 series housings from separating. Retaining pins are inserted in the circular opening between two housings stacked side by side. Dimension B is +/- 0.015 in or 0.38 mm.

Description	Part Numbers		Dimensions			
			- A -		- B -	
			inches	mm	inches	mm
Minimum Quantity ...	1,000	100				
1 Block High	111812P7	110G19	0.196 / 0.207	4.98 / 5.26	0.560	14.220
2 Block High	111812P6	110G18	0.196 / 0.207	4.98 / 5.26	1.000	25.400



PCB Mounting Staples

Reduce strain on solder joints during mating and unmating. Staples bend over the underside of the PCB board to lock the housings in place. Staples are an interference fit with housings.

Part Numbers	Number of Stacked Powerpoles® H x W
Minimum Quantity ...	100
PCSTAPLE-1	1 x 1
PCSTAPLE-2	1 x 2

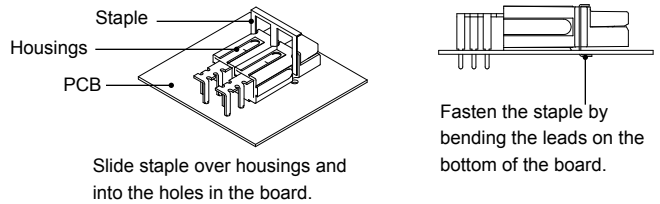

Reducing Bushings

Use with contact part number 5900-BK or 1307-BK to allow a smaller wire to be used with the connector. Electrical capability is derated with smaller wire.

Contact Barrel Size	Wire Size	Part Numbers			Dimensions			
					- ID -		- Length -	
					inches	mm	Inches	mm
Minimum Quantity ...		3,000	1,000	100				
#6 AWG [13.3 mm²]	#8 AWG [8.4 mm²]	-	5912-BK	5912	0.18	4.57	0.45	11.43
#6 AWG [13.3 mm²]	#12- 10 AWG [3.3- 5.3 mm²]	5910-BK	-	5910	0.14	3.56	0.47	11.94
#6 AWG [13.3 mm²]	#16- 14 AWG [1.3- 2.1 mm²]	5913-BK	-	5913	0.09	2.29	0.47	11.94



For environmentally sealed connector shells to hold Powerpole® 15-180 connectors, see APP®'s SPEC Pak® product series on our website, www.andersonpower.com



Powerpole®

- Tooling Information

Wire Size		Reeled Part Numbers		Reeled Contact Crimp Tool				
AWG	mm²	Tin Plating	Silver Plating	APP Applicator +	APP Press or	ATS Applicator +	ATS Press +	Air Feed Kit *
PP15 / 45 Flat Wiping Power & Ground								
#16 / 20	1.3 / 0.52	262G1	262G2	TD0101	115V= TE0101 230V = TE0102	1385519-1	1725900-2 or [354500-1]	1424266-1 or [354578-1]
#16 / 20	1.3 / 0.52	269G2	N/A			1385519-1		
#12 / 16	3.3 / 1.3	261G1	261G4			1385520-1		
#10 / 14	5.3 / 2.1	261G2	261G3			1385458-1		
#12 / 16	3.3 / 1.3	269G1	N/A			1385520-1		
#10 / 14	5.3 / 2.1	269G3	N/A			1385458-1		
#10 / 14	5.3 / 2.1	200G1L	200G3L	TD0102		1385460-1		
#10 / 14	5.3 / 2.1	201G1H	201G3H			1385460-1		
#10 / 14	5.3 / 2.1	1830G1	1830G2			1385460-1		
#10 / 14	5.3 / 2.1					1385460-1		

NOTE: Insertion / Extraction tool for PP15/45 contacts = 111038G2

* All ATS applicators for APP® contacts are air feed style, (except 1385870) and require the press to have an air feed kit installed. APP applicators are mechanical feed style and do not require an air feed kit.

Wire Size		Loose Piece Part Numbers		Loose Piece Contact Crimp Tool								
AWG	mm²	Tin Plating	Silver Plating	Hand Tool or	Pneumatic Bench Tool +	Die +	Locator	Number of Crimps				
PP15 / 45 Flat Wiping Power & Ground												
#16 / 20	1.3 / 0.52	N/A	1332	1309G2 or 1309G8	1367G1							
#12 / 16	3.3 / 1.3	N/A	1331									
#16 / 20	1.3 / 0.52	262G1-LPBK	262G2-LPBK									
#16 / 20	1.3 / 0.52	269G2-LPBK	N/A									
#12 / 16	3.3 / 1.3	261G1-LPBK	261G4-LPBK	1309G3 or 1309G8	N/A	N/A	N/A	Single				
#10 / 14	5.3 / 2.1	261G2-LPBK	261G3-LPBK									
#12 / 16	3.3 / 1.3	269G1-LPBK	N/A									
#10 / 14	5.3 / 2.1	269G3-LPBK	N/A									
#10 / 14	5.3 / 2.1	200G1L-LPBK	200G3L-LPBK	1309G6 or 1309G8								
#10 / 14	5.3 / 2.1	201G1H-LPBK	201G3H-LPBK									
310 / 14	5.3 / 2.1	1830G1-LPBK	1830G2-LPBK									
PP75												
#6	13.3	N/A	1307	1309G4	1387G1			1389G6				
			5900					1388G6	1389G21			
#8	8.4		1875G1					1388G6	1389G6			
			5952						1389G21			
#10 / 12	5.3 / 3.3		1875G2					1388G7	1389G6			
			5953						1389G21			
			5915						1389G6			
			1875G3						1389G21			
PP120												
1/0	53.5	N/A	1323G2	1368 Series	1387G1			1388G3				
#1	42.4		1323G1					1389G4				
#2	33.6		1319					1388G4				
#4	21.2		1319G4									
#6	13.3		1319G6									
PP180												
3/0	85	N/A	1328G2	1368 Series	1387G2	1303G12	1304G32	Double				
2/0	53.5		1328G1									
1/0	53.5		1382									
#1	42.4		1347									
#2	33.6		1383									
#4	21.1		1384									
#6	13.3		1348									
									1387G1	1388G4	1389G3	Single

1. NOTE: See website for the most current information.

2. NOTE: Insertion / Extraction tool for PP15/45 contacts = 111038G2



Компания «ЭлектроПласт» предлагает заключение долгосрочных отношений при поставках импортных электронных компонентов на взаимовыгодных условиях!

Наши преимущества:

- Оперативные поставки широкого спектра электронных компонентов отечественного и импортного производства напрямую от производителей и с крупнейших мировых складов;
- Поставка более 17-ти миллионов наименований электронных компонентов;
- Поставка сложных, дефицитных, либо снятых с производства позиций;
- Оперативные сроки поставки под заказ (от 5 рабочих дней);
- Экспресс доставка в любую точку России;
- Техническая поддержка проекта, помощь в подборе аналогов, поставка прототипов;
- Система менеджмента качества сертифицирована по Международному стандарту ISO 9001;
- Лицензия ФСБ на осуществление работ с использованием сведений, составляющих государственную тайну;
- Поставка специализированных компонентов (Xilinx, Altera, Analog Devices, Intersil, Interpoint, Microsemi, Aeroflex, Peregrine, Syfer, Eurofarad, Texas Instrument, Miteq, Cobham, E2V, MA-COM, Hittite, Mini-Circuits, General Dynamics и др.);

Помимо этого, одним из направлений компании «ЭлектроПласт» является направление «Источники питания». Мы предлагаем Вам помощь Конструкторского отдела:

- Подбор оптимального решения, техническое обоснование при выборе компонента;
- Подбор аналогов;
- Консультации по применению компонента;
- Поставка образцов и прототипов;
- Техническая поддержка проекта;
- Защита от снятия компонента с производства.



Как с нами связаться

Телефон: 8 (812) 309 58 32 (многоканальный)

Факс: 8 (812) 320-02-42

Электронная почта: org@eplast1.ru

Адрес: 198099, г. Санкт-Петербург, ул. Калинина, дом 2, корпус 4, литера А.