

4xØ2.79±0.12 x8.0 DP
RECOMMENDED SCREW: 4-20 [M3.12 x 1.27]
THREAD-FORMING SCREW,
TORQUE:6-10 IN-LB [0.68-1.13 NM]

REVISIONS					
REV	ECO	DESCRIPTION	DATE	BY	APPR
A1	--	RELEASE NEW DRAWING	19JUN18	JONY	TOMMY

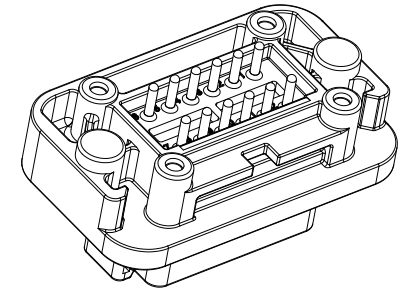
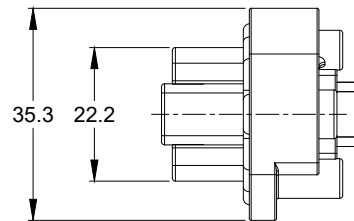
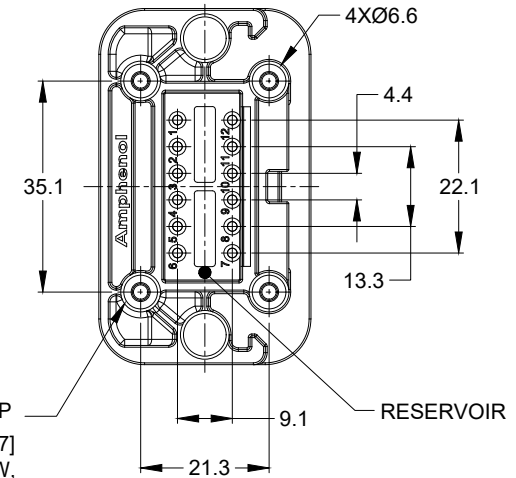

NOTES: UNLESS OTHERWISE SPECIFIED

- MATERIAL:
HOUSING: THERMOPLASTIC
SEAL: SILICONE RUBBER
CONTACT: COPPER ALLOY
- MODIFICATIONS: FLANGE, PCB MOUNT STRAIGHT
- SPECIFICATIONS:
3.1 CURRENT RATING: 13 AMPS
3.2 OPERATING TEMPERATURE: -55°C TO +125°C
3.3 DIELECTRIC WITHSTANDING VOLTAGE: LESS THAN 2 MILLIAMPS CURRENT LEAKAGE @ 1500 VOLTS AC.
3.4 INSULATION RESISTANCE: 1000 MEGOHMS MIN @ 25°C.
3.5 MOISTURE RESISTANCE: IP67 (MATED CONDITION)
3.6 MATING CYCLE DURABILITY: 100 CYCLES
3.7 RoHS COMPLIANT
- MATING PART: AT06-12S* PLUG
(* = MODIFICATIONS)
- ALL DIMENSIONS ARE FOR REFERENCE USE ONLY.

AT15-12PX-BMXX		DESCRIPTION		ITEM
PART NUMBER				
QUANTITY	MATERIALS LIST			
UNLESS OTHERWISE SPECIFIED 1) All dimensions are in metric(mm). 2) Tolerances are as follows: 1 PL DEC ±0.30 Fractions ±1/64 2 PL DEC ±0.15 Angles ±1° 3 PL DEC ±0.08		SIGNATURES		DATE
3) Note reference =		DRAWN: JONY.XIE		19JUN18
MATERIAL SPECIFICATIONS:		CHECKED: ORION.LI		19JUN18
PROCESS SPECIFICATIONS:		ENGINEER:		
NEXT ASSY:		APPROVAL: TOMMY.XIE		19JUN18
		CUSTOMER:		
		THIS DRAWING IS SUPPLIED FOR INFORMATION ONLY. DESIGN FEATURES, SPECIFICATIONS AND PERFORMANCE DATA SHOWN HEREON ARE THE PROPERTY OF THE AMPHENOL CORPORATION. NO RIGHTS OF REPRODUCTION ARE IMPLIED. ALL DIMENSIONS ARE SUBJECT TO NORMAL MANUFACTURING VARIATIONS.		
SIZE	TYPE	DWG NO:	REVISION	
B	C-	AT15-12PX-BMXX	A1	
SCALE:	NONE	SHEET 1 OF 3		

TITLE: PCB MOUNT RECEPTACLE 12PIN STRAIGHT AT SERIES
DWG NO: AT15-12PX-BMXX
REV: A1
SH: 1
OF: 3

REVISIONS					
REV	ECO	DESCRIPTION	DATE	BY	APPR
A1	--	RELEASE NEW DRAWING	19JUN18	JONY	TOMMY

P/N AT15-12PA-BMXX
KEY-A CONFIGURATION
STANDARD COLOR: GREY

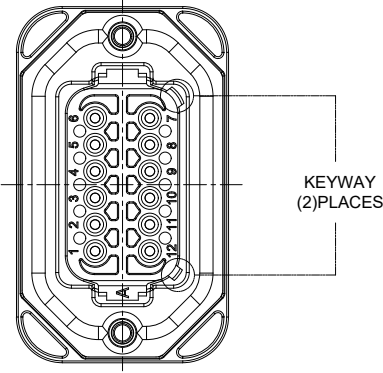

P/N AT15-12PB-BMXX
KEY-B CONFIGURATION
STANDARD COLOR: BLACK

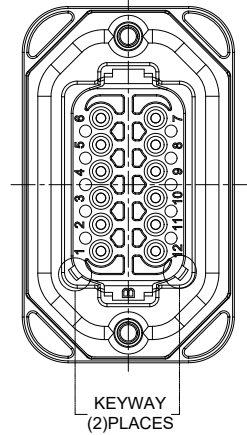

AT15-12PA-BMXX VARIANTS		
CONTACT PLATING	POTTING OR NOT IN RESERVOIR	PART NUMBER
GOLD	NO POTTING	AT15-12PA-BM01
GOLD	POTTING	AT15-12PA-BM02
TIN	NO POTTING	AT15-12PA-BM03
TIN	POTTING	AT15-12PA-BM04

AT15-12PB-BMXX VARIANTS		
CONTACT PLATING	POTTING OR NOT IN RESERVOIR	PART NUMBER
GOLD	NO POTTING	AT15-12PB-BM01
GOLD	POTTING	AT15-12PB-BM02
TIN	NO POTTING	AT15-12PB-BM03
TIN	POTTING	AT15-12PB-BM04

AT15-12PX-BMXX		DESCRIPTION		ITEM
PART NUMBER				
QUANTITY	MATERIALS LIST			
UNLESS OTHERWISE SPECIFIED		SIGNATURES		DATE
1) All dimensions are in metric (mm).		DRAWN: JONY.XIE		19JUN18
2) Tolerances are as follows:		CHECKED: ORION.LI		19JUN18
1 PL DEC ±0.30 Fractions ±1/64		ENGINEER:		
2 PL DEC ±0.15		APPROVAL: TOMMY.XIE		19JUN18
3 PL DEC ±0.08		CUSTOMER:		
3) Note reference =		THIS DRAWING IS SUPPLIED FOR INFORMATION ONLY. DESIGN FEATURES, SPECIFICATIONS AND PERFORMANCE DATA SHOWN HEREON ARE THE PROPERTY OF THE AMPHENOL CORPORATION. NO RIGHTS OF REPRODUCTION ARE IMPLIED. ALL DIMENSIONS ARE SUBJECT TO NORMAL MANUFACTURING VARIATIONS.		
MATERIAL SPECIFICATIONS:		SIZE		REVISION
PROCESS SPECIFICATIONS:		B C-		A1
NEXT ASSY:		DWG NO. AT15-12PX-BMXX		
		SCALE: NONE		SHEET 2 OF 3

TITLE: PCB MOUNT RECEPTACLE 12PIN STRAIGHT AT SERIES
DWG NO.: AT15-12PX-BMXX
REV: A1
SH: 2
OF: 3

P/N AT15-12PC-BMXX
KEY-C CONFIGURATION
STANDARD COLOR: GREEN

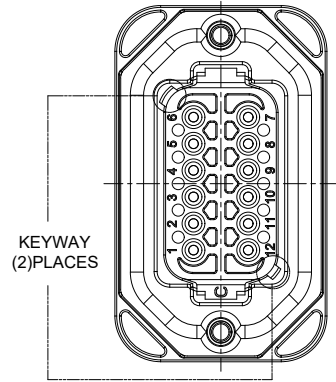

KEYWAY
(2) PLACES

AT15-12PC-BMXX VARIANTS		
CONTACT PLATING	POTTING OR NOT IN RESERVOIR	PART NUMBER
GOLD	NO POTTING	AT15-12PC-BM01
GOLD	POTTING	AT15-12PC-BM02
TIN	NO POTTING	AT15-12PC-BM03
TIN	POTTING	AT15-12PC-BM04

REVISIONS					
REV	ECO	DESCRIPTION	DATE	BY	APPR
01	--	RELEASE NEW DRAWING	19JUN18	JONY	TOMMY

P/N AT15-12PD-BMXX
KEY-D CONFIGURATION
STANDARD COLOR: BROWN

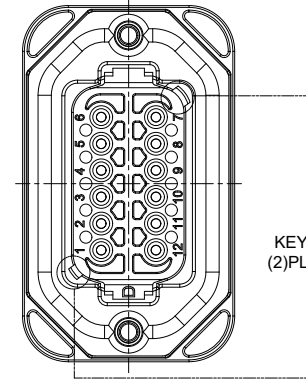

KEYWAY
(2) PLACES

AT15-12PD-BMXX VARIANTS		
CONTACT PLATING	POTTING OR NOT IN RESERVOIR	PART NUMBER
GOLD	NO POTTING	AT15-12PD-BM01
GOLD	POTTING	AT15-12PD-BM02
TIN	NO POTTING	AT15-12PD-BM03
TIN	POTTING	AT15-12PD-BM04

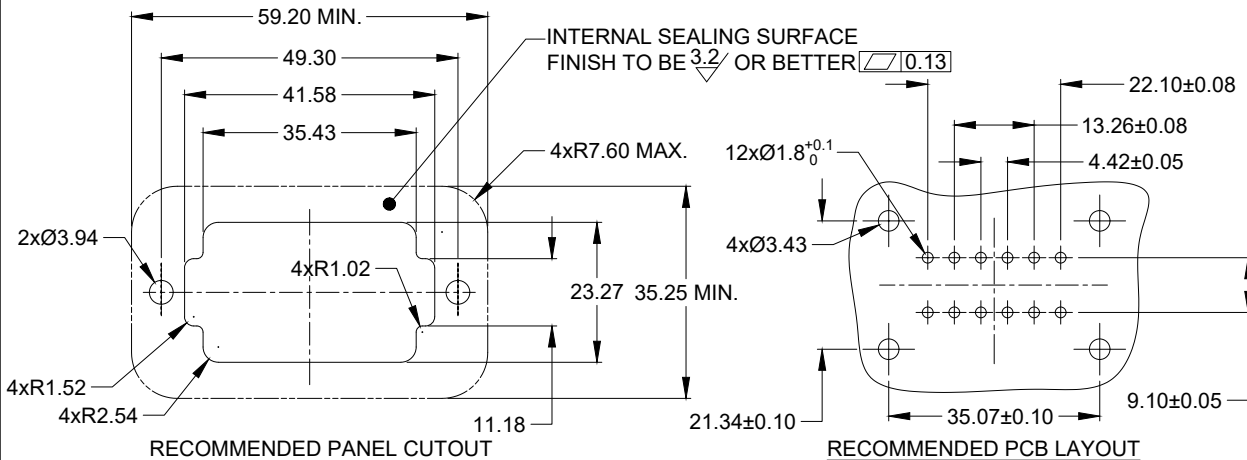

AT15-12PX-BMXX		DESCRIPTION		ITEM
QUANTITY	PART NUMBER	MATERIALS LIST		
UNLESS OTHERWISE SPECIFIED		SIGNATURES DATE		
1) All dimensions are in metric (mm).		DRAWN: JONY.XIE	19JUN18	
2) Tolerances are as follows:		CHECKED: ORION.LI	19JUN18	
1 PL DEC ±0.30 Fractions ±1/64		ENGINEER:		
2 PL DEC ±0.15 Angles ±1°		APPROVAL: TOMMY.XIE	19JUN18	
3 PL DEC ±0.08		CUSTOMER:		
3) Note reference = Δ		THIS DRAWING IS SUPPLIED FOR INFORMATION ONLY. DESIGN FEATURES, SPECIFICATIONS AND PERFORMANCE DATA SHOWN HEREON ARE THE PROPERTY OF THE AMPHENOL CORPORATION. NO RIGHTS OF REPRODUCTION ARE IMPLIED. ALL DIMENSIONS ARE SUBJECT TO NORMAL MANUFACTURING VARIATIONS.		
MATERIAL SPECIFICATIONS:		Sine Systems - www.amphenol-sine.com 44724 Morley Drive Clinton Township, MI 48036		
PROCESS SPECIFICATIONS:		PCB MOUNT RECEPTACLE 12PIN STRAIGHT AT SERIES		
NEXT ASSY:		SIZE: B	TYPE: C-	REVISION: A1
		DWG NO: AT15-12PX-BMXX		
		SCALE: NONE		SHEET 3 OF 3

TITLE: PCB MOUNT RECEPTACLE 12PIN STRAIGHT AT SERIES
DWG NO: AT15-12PX-BMXX
REV: A1
SH: 3
OF: 3



Компания «ЭлектроПласт» предлагает заключение долгосрочных отношений при поставках импортных электронных компонентов на взаимовыгодных условиях!

Наши преимущества:

- Оперативные поставки широкого спектра электронных компонентов отечественного и импортного производства напрямую от производителей и с крупнейших мировых складов;
- Поставка более 17-ти миллионов наименований электронных компонентов;
- Поставка сложных, дефицитных, либо снятых с производства позиций;
- Оперативные сроки поставки под заказ (от 5 рабочих дней);
- Экспресс доставка в любую точку России;
- Техническая поддержка проекта, помощь в подборе аналогов, поставка прототипов;
- Система менеджмента качества сертифицирована по Международному стандарту ISO 9001;
- Лицензия ФСБ на осуществление работ с использованием сведений, составляющих государственную тайну;
- Поставка специализированных компонентов (Xilinx, Altera, Analog Devices, Intersil, Interpoint, Microsemi, Aeroflex, Peregrine, Syfer, Eurofarad, Texas Instrument, Miteq, Cobham, E2V, MA-COM, Hittite, Mini-Circuits, General Dynamics и др.);

Помимо этого, одним из направлений компании «ЭлектроПласт» является направление «Источники питания». Мы предлагаем Вам помощь Конструкторского отдела:

- Подбор оптимального решения, техническое обоснование при выборе компонента;
- Подбор аналогов;
- Консультации по применению компонента;
- Поставка образцов и прототипов;
- Техническая поддержка проекта;
- Защита от снятия компонента с производства.



Как с нами связаться

Телефон: 8 (812) 309 58 32 (многоканальный)

Факс: 8 (812) 320-02-42

Электронная почта: org@eplast1.ru

Адрес: 198099, г. Санкт-Петербург, ул. Калинина, дом 2, корпус 4, литера А.