

BLCR SERIES LOW VOLTAGE PRESSURE SENSORS

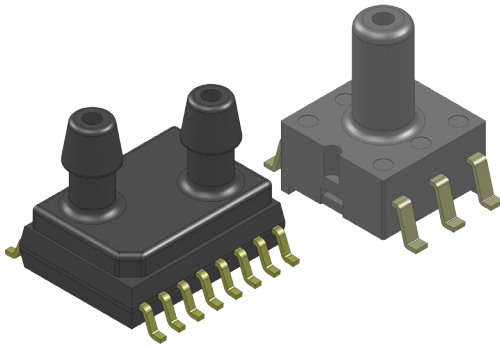

Features

- 0 to 1 inH2O to 0 to 30 inH2O Pressure Ranges
- Low Supply Voltage (1.8V to 3.3V)
- 0.1% Linearity Typical
- Improved Front to Back Linearity
- Intrinsically No Position Sensitivity
- Improved Warm-Up Shift Distribution
- Parylene Coating Available Upon Request
- Reduced TCO

Applications

- Medical Instrumentation
- Environmental Controls
- HVAC

General Description

The BLCR Series Basic Sensor is based on a Dual Die Reference technology to reduce all output offset or common mode errors. It also incorporates All Sensors CoBeam² Technology to reduce the overall supply voltage while maintaining comparable output levels to traditional equivalent basic sensing elements. This lower supply voltage gives rise to improved warm-up shift while the CoBeam² Technology itself reduces package stress susceptibility resulting in improved overall long term stability. The technology also vastly improves position sensitivity to nearly unmeasurable levels.

This series is intended for use with non-corrosive, non-ionic working fluids such as air, dry gases and the like. The output is also ratio-metric to the supply voltage and is operable from 1.8 to 3.3 volts DC.

Standard Pressure Ranges

Device	Operating Range	Proof Pressure	Burst Pressure
BLCR-L01D	±1 inH2O (249 Pa)	100 inH2O (25 KPa)	150 inH2O (37 KPa)
BLCR-L05D	±5 inH2O (1,245 Pa)	200 inH2O (50 KPa)	300 inH2O (75 KPa)
BLCR-L10D	±10 inH2O (2,491 Pa)	200 inH2O (50 KPa)	300 inH2O (75 KPa)
BLCR-L20D	±20 inH2O (4,982 Pa)	200 inH2O (50 KPa)	500 inH2O (125 KPa)
BLCR-L30D	±30 inH2O (7,472 Pa)	200 inH2O (50 KPa)	800 inH2O (200 KPa)

Pressure Sensor Maximum Ratings		Environmental Specifications	
Supply Voltage (Vs)	5 Vdc	Temperature Ranges	
Common Mode Pressure	5 psig	Operating	-25 to 85 °C
Lead Temperature (soldering 2-4 sec.)	270 °C	Storage	-40 to 125 °C
		Humidity Limits	0 to 95% RH (non condensing)

Performance Characteristics for BLCR Series

ALL PARAMETERS ARE MEASURED AT 3.3 VOLT EXCITATION AND ROOM TEMPERATURE UNLESS OTHERWISE SPECIFIED. PRESSURE MEASUREMENTS ARE WITH POSITIVE PRESSURE APPLIED TO PORT B (THE ONLY PORT FOR THE SINGLE PORT CONFIGURATION).

Parameter	Min	Typ	Max	Units	Notes
Output Span (FSS)					4
L01D	4.5	8.0	11.5	mV	
L05D	13.5	24.0	34.5	mV	
L10D	18.0	32.0	46.0	mV	
L20D	22.0	38.0	55.0	mV	
L30D	25.0	42.0	60.0	mV	
Offset Voltage @ Zero Diff. Pressure	-	-	±10.0	mV	-
Offset Temperature Shift (0°C-70°C)	-	±4.0	-	µV/°C	1
Offset Warm-up Shift	-	±10.0	-	µV	2, 6
Offset Position Sensitivity (1g)	-	±0.2	-	µV	-
Linearity, Hysteresis Error	-	0.1	±0.5	%FSS	3
Response Time (10% to 90% Pressure Response)	-	100.0	-	µS	-
Front to Back Linearity	-	0.25	-	%FSS	5
Temperature Effect on Resistance (0°C-70°C)	-	2800	-	ppm/°C	-
Temperature Effect on Span (0°C-70°C)	-	-2000	-	ppm/°C	-
Input Resistance	-	1.7	-	kΩ	-
Output Resistance	-	1.7	-	kΩ	-

Specification Notes

NOTE 1: SHIFT IS RELATIVE TO 25°C.

NOTE 2: SHIFT IS WITHIN THE FIRST HOUR OF EXCITATION APPLIED TO THE DEVICE.

NOTE 3: MEASURED AT ONE-HALF FULL SCALE RATED PRESSURE USING BEST STRAIGHT LINE CURVE FIT.

NOTE 4: THE SPAN IS THE ALGEBRAIC DIFFERENCE BETWEEN FULL SCALE OUTPUT VOLTAGE AND THE OFFSET VOLTAGE.

NOTE 5: FRONT-BACK LINEARITY COMPUTED AS:
$$Lin_{FB} = \left(\left| \frac{Span_{PortB}}{Span_{PortA}} - 1 \right| \right) \cdot 100\%$$

NOTE 6: TYPICAL WARM UP CHARACTERISTICS AS SHOWN BELOW.

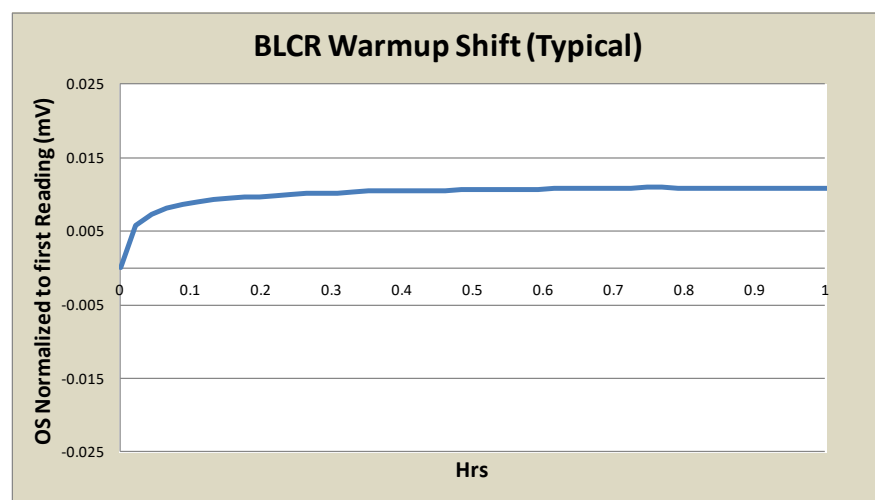

Soldering Recommendations

- 1) Solder parts as a second operation only.
- 2) Post reflow, wait for 36 hrs before performing any calibration operations.
- 3) Perform spot cleaning as necessary only by hand. DO NOT wash or submerge device in cleaning liquid.

Package Drawings (Cont'd)

D4 Package

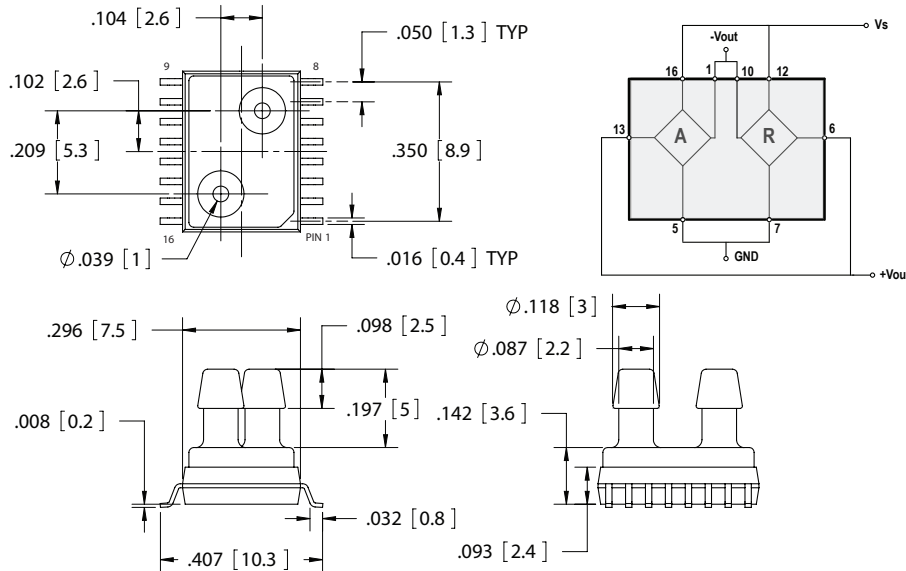

Pin	Definition
1	-OutA
2	N/C
3	N/C
4	N/C
5	GndA
6	-OutR
7	GndR
8	N/C
9	N/C
10	+OutR
11	N/C
12	+VsR
13	+OutA
14	N/C
15	N/C
16	+VsA

NOTES

- 1) Dimensions are in inches [mm].
- 2) Pins 12 and 16 must be connected for Vs input.
- 3) Pins 5 and 7 must be connected for Gnd.
- 4) Pins 1 and 10 must be connected for -Vout.
- 5) Pins 6 and 13 must be connected for +Vout.
- 6) For suggested pad layout, see drawing: PAD-22.

All Sensors

TITLE:	D-Series Package	
SIZE	FILE NAME	
A	D4 Package	

How To Order

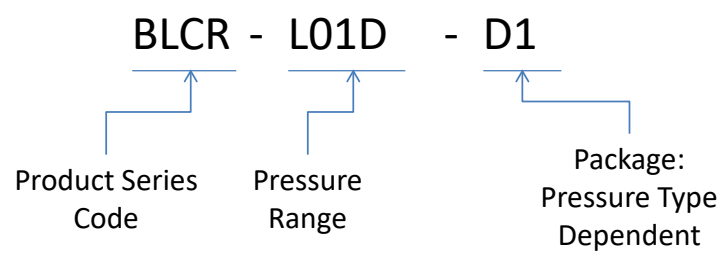

Where:
 Pressure Range (D1, D3, D4 Packages — Differential Only): L01D, L05D, L10D, L20D, L30D
 Pressure Range (U1, U2 Package — Gage Only): L01D, L05D, L10D, L20D, L30D

(Consult with factory for parylene coating)

Packaging



ALL PRODUCTS FOUND IN THIS DATASHEET ARE PACKAGED IN TUBES WITH PIN 1 ORIENTED TOWARDS THE WHITE STOPPER.

Suggested Pad Layout

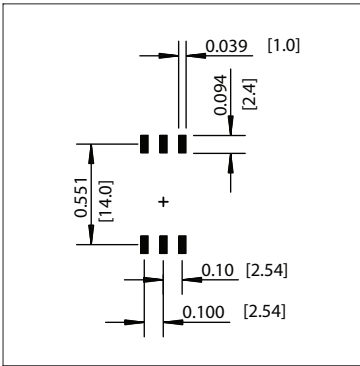

PAD-20

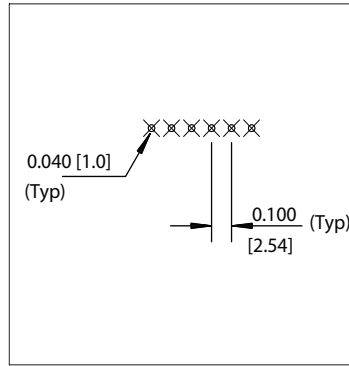

PAD-21

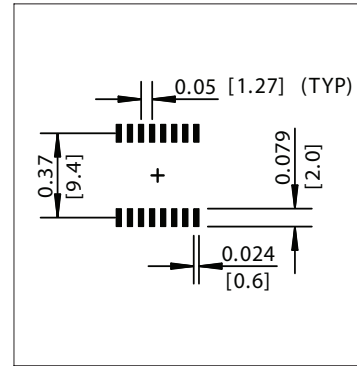

PAD-22

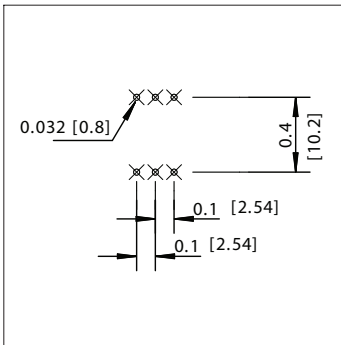

PAD-23

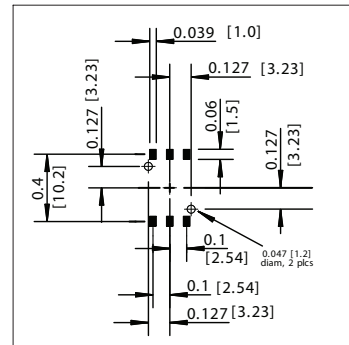

PAD-24

Dimensions are in inches [mm].

All Sensors reserves the right to make changes to any products herein. All Sensors does not assume any liability arising out of the application or use of any product or circuit described herein, neither does it convey any license under its patent rights nor the rights of others.



Компания «ЭлектроПласт» предлагает заключение долгосрочных отношений при поставках импортных электронных компонентов на взаимовыгодных условиях!

Наши преимущества:

- Оперативные поставки широкого спектра электронных компонентов отечественного и импортного производства напрямую от производителей и с крупнейших мировых складов;
- Поставка более 17-ти миллионов наименований электронных компонентов;
- Поставка сложных, дефицитных, либо снятых с производства позиций;
- Оперативные сроки поставки под заказ (от 5 рабочих дней);
- Экспресс доставка в любую точку России;
- Техническая поддержка проекта, помощь в подборе аналогов, поставка прототипов;
- Система менеджмента качества сертифицирована по Международному стандарту ISO 9001;
- Лицензия ФСБ на осуществление работ с использованием сведений, составляющих государственную тайну;
- Поставка специализированных компонентов (Xilinx, Altera, Analog Devices, Intersil, Interpoint, Microsemi, Aeroflex, Peregrine, Syfer, Eurofarad, Texas Instrument, Miteq, Cobham, E2V, MA-COM, Hittite, Mini-Circuits, General Dynamics и др.);

Помимо этого, одним из направлений компании «ЭлектроПласт» является направление «Источники питания». Мы предлагаем Вам помощь Конструкторского отдела:

- Подбор оптимального решения, техническое обоснование при выборе компонента;
- Подбор аналогов;
- Консультации по применению компонента;
- Поставка образцов и прототипов;
- Техническая поддержка проекта;
- Защита от снятия компонента с производства.



Как с нами связаться

Телефон: 8 (812) 309 58 32 (многоканальный)

Факс: 8 (812) 320-02-42

Электронная почта: org@eplast1.ru

Адрес: 198099, г. Санкт-Петербург, ул. Калинина, дом 2, корпус 4, литера А.