



Film Capacitors

Power Electronic Capacitors

Series/Type: MKP DC
Ordering code: B2562*
Date: May 2018
Version: 12

© EPCOS AG 2018. Reproduction, publication and dissemination of this publication, enclosures hereto and the information contained therein without EPCOS' prior express consent is prohibited.

EPCOS AG is a TDK Group Company.

Construction

1. Construction and general data

| Characteristics | |
|--|--|
| Standard capacitance tolerance | K: $\pm 10\%$ |
| Dielectric dissipation factor ($\tan \delta_o$) | $2 \cdot 10^{-4}$ |
| Loss factor ($\tan \delta$) at 100 Hz | $\leq 1.2 \cdot 10^{-3}$ for $C_R < 450 \mu\text{F}$ $\leq 1.5 \cdot 10^{-3}$ for $450 \mu\text{F} \leq C_R \leq 800 \mu\text{F}$ $\leq 2.0 \cdot 10^{-3}$ for $C_R > 800 \mu\text{F}$ |
| Service life expectancy (refer to section 3) | 100 000 h at $\Theta_{\text{hs}} +75 \text{ }^\circ\text{C}$ und V_{RDC} up to 200 000 h (Considering de-ratings in voltage and/or temperature (upon request)) |
| Fit rate | 50 at V_{RDC} and $+70 \text{ }^\circ\text{C}$ (refer to section 4) |
| Minimum temperature $\Theta_{\text{min.}}$ | $-55 \text{ }^\circ\text{C}$ |
| Maximum temperature $\Theta_{\text{max.}}$ | $+85 \text{ }^\circ\text{C}$ for diameter 85 mm $+75 \text{ }^\circ\text{C}$ for diameter 116 mm |
| Storage temperature Θ_{stg} | $-55 \dots +85 \text{ }^\circ\text{C}$ |
| Maximum hotspot temperature Θ_{hs} (refer to section 1) | $+85 \text{ }^\circ\text{C}$ for diameter 85 mm $+75 \text{ }^\circ\text{C}$ for diameter 116 mm |
| Climatic category | 55/85/56 for 85 mm diameter 55/75/56 for 116 mm diameter |
| Maximum altitude | 2000 m above sea level (derating curves available upon request) |
| Frequency range | 100 Hz to 10 kHz (High frequency designs available upon request) |

| Test data | |
|--|--|
| Voltage between terminals V_{TT} | $1.5 V_{\text{RDC}}$, 10 s |
| Voltage between terminals and case U_{TC} | 4000 V AC, 10 s |
| Life test | According to IEC 61071 |
| Cooling | Naturally air-cooled (or forced air cooling) |
| Degree of protection | Indoor mounting |

| Design data | |
|-----------------------------|---|
| Resin filling | Non PCB, hard polyurethane (dry type) |
| Mounting and grounding | M12 threaded bolt on bottom of the aluminum case |
| Max. torque (case) M12 stud | 10 Nm |
| Max. torque terminal | Female M6: 5 Nm Female M8: 6 Nm Male M8: 8 Nm |

| Reference standards | |
|--|--|
| IEC 61071 | |
| RoHS compliance | |
| Certification: UL 810-5th edition (refer to table 1.3) | |

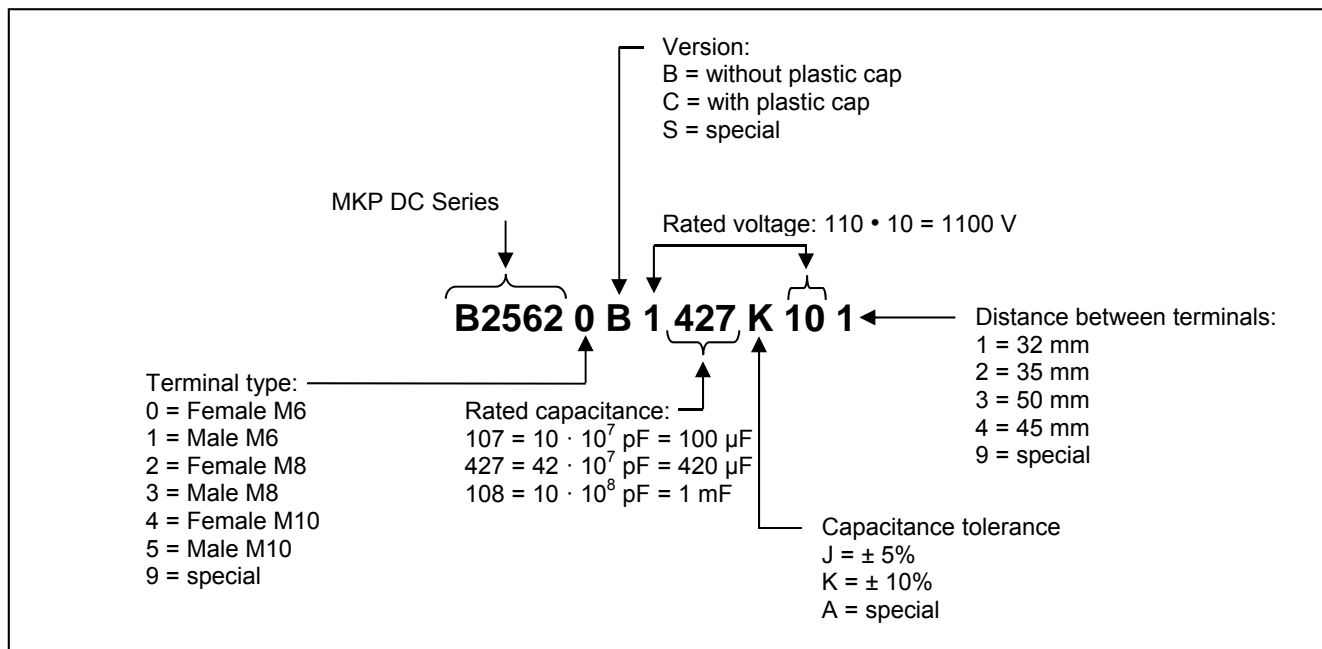
1.1 Structure of ordering code

1.2 Standard types

| Diameter (Ø) Terminal type | | D (mm) OC ending | 32 ± 0.5 - **1 | 50 ± 0.5 - **3 |
|-------------------------------|-----------------------|---------------------|-----------------------|-----------------------|
| | | | | |
| 85 mm | Female M6 (B25620) | | standard | |
| 116 mm | Female M6 (B25620) | | | standard |

Other terminal configurations upon request.

1.3 UL approved types

| Diameter (Ø) | Series |
|--------------|-----------------------------------|
| 85 mm | B2562xC |
| 116 mm | Hc = 70 to 290 mm approved |
| | Hc = 290 to 345 mm under approval |

1.4 Drawings

Figure 1: - B25620B - Ø 85mm
 - Female terminals (M6)
 - Between terminals $32 \pm 0.5\text{mm}$

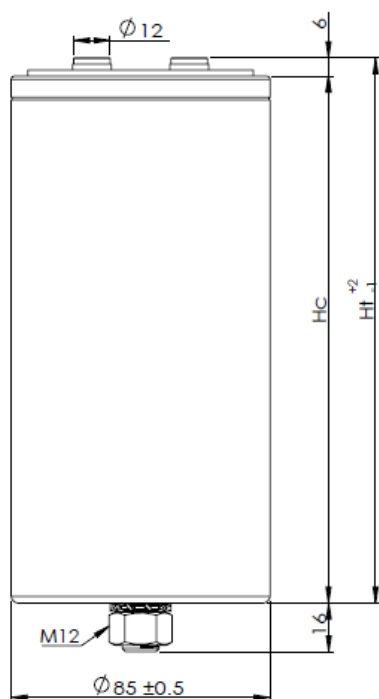

Figure 2: - B25620C - Ø 85mm
 - Female terminals (M6)
 - Between terminals $32 \pm 0.5\text{mm}$

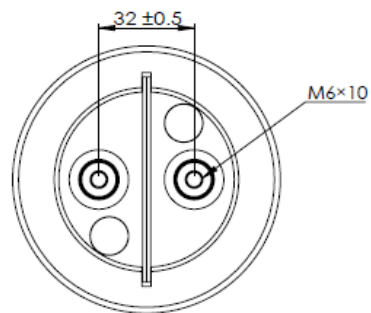
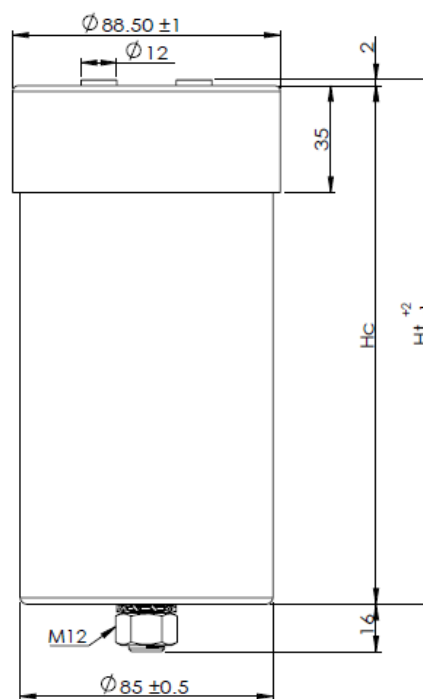
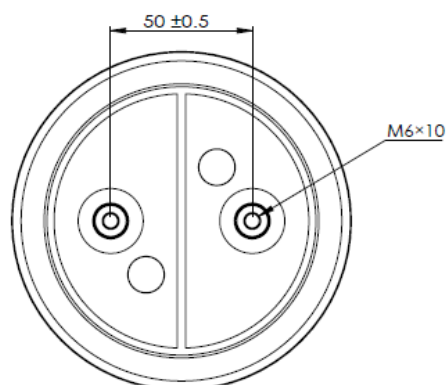
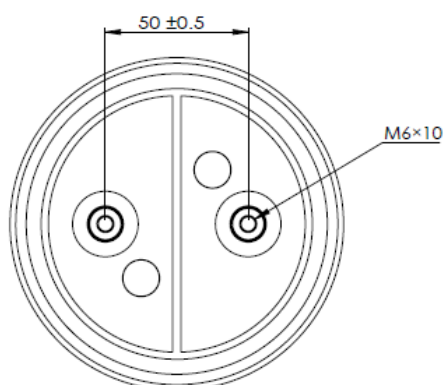
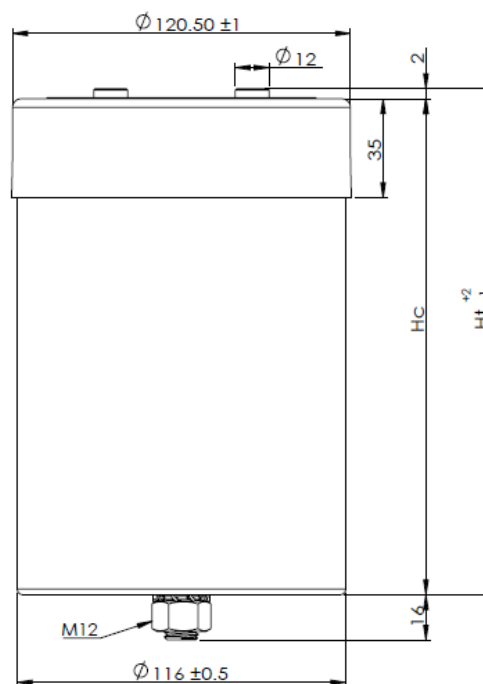

Figure 3: - B25620B - Ø 116mm
 - Female terminals (M6)
 - Between terminals 50 ±0.5mm



Figure 4: - B25620C - Ø 116mm
 - Female terminals (M6)
 - Between terminals 50 ±0.5mm



M12 stud on bottom of the aluminum case, nut and washer for fixing are standard for all types.

Terms and characteristics

The following definitions apply to power capacitors according to IEC 61071.

Rated capacitance C_R

Nominal value of the capacitance at +20 °C and measuring frequency range of 50 to 120 Hz.

Rated DC voltage V_{RDC}

Maximum operating peak voltage of either polarity but of a non-reversing type wave form, for which the capacitor has been designed, for continuous operation.

Ripple voltage V_r

Peak-to-peak alternating component of the unidirectional voltage.

This value must not exceed $0.28 \cdot V_{RDC}$

Maximum surge voltage V_s

Peak voltage induced by a switching or any other disturbance of the system which is allowed for a limited number of times and short period.

Insulation voltage V_i

RMS rated value of the insulation voltage of capacitive elements and terminals to case or earth. When it is not specified in the product data sheet, the insulation voltage is at least:

$$V_i = \frac{V_R}{\sqrt{2}}$$

Maximum rate of voltage rise $(du/dt)_{max}$

Maximum permissible repetitive rate of voltage rise of the operational voltage.

Maximum current I_{max}

Maximum RMS current for continuous operation for the given frequency range and for the maximum ripple voltage. Please provide Frequency Spectrum of RMS current to your sales contact.

Maximum peak current \hat{I}

Maximum permissible repetitive current amplitude during continuous operation.

Maximum peak current (\hat{I}) and maximum rate of voltage rise $(du/dt)_{max}$ on a capacitor are related as follows:

$$\hat{I} = C \cdot (dv/dt)_{max}$$

Maximum surge current \hat{I}_s

Admissible peak current induced by a switching or any other disturbance of the system which is allowed for a limited number of times and short period.

$$\hat{I}_s = C \cdot (dv/dt)_s$$

Ambient temperature Θ_A

Temperature of the surrounding air, measured at 10 cm distance and 2/3 of the case height of the capacitor.

Lowest operating temperature Θ_{min}

Lowest permitted ambient temperature at which a capacitor may be energized.

Maximum operating temperature Θ_{max}

Highest permitted capacitor temperature during operation, i.e. temperature at the hottest point of the case.

Hot-spot temperature Θ_{hs}

Temperature zone inside of the capacitor at hottest spot.

$$\Theta_{hs} = T_{amb} + I_{RMS}^2 \cdot ESR \cdot R_{th}$$

Tangent of the loss angle of a capacitor $\tan \delta$

Ratio between the equivalent series resistance and the capacitive reactance of a capacitor at a specified sinusoidal alternating voltage, frequency and temperature.

Series resistance R_s

The sum of all ohmic resistances occurring inside the capacitor.

ESR

ESR (Equivalent Series Resistance) representing entire active power in capacitor.

$$ESR = \frac{\tan \delta}{\omega \cdot C} = R_s + \frac{\tan \delta_0}{\omega \cdot C}$$

Thermal resistance R_{th}

The thermal resistance indicates by how many degrees the capacitor temperature at the hot spot rises in relation to the dissipation losses.

Maximum power loss P_{max}

Maximum permissible power dissipation for the capacitor's operation.

$$P_{max} = \frac{\Theta_{hs} - \Theta_A}{R_{th}}$$

Self inductance L_{self}

The sum of all inductive elements which are contained in a capacitor.

Resonance frequency f_r

The lowest frequency at which the impedance of the capacitor becomes minimum.

$$f_r = \frac{1}{2\pi \cdot \sqrt{L_{self} \cdot C_R}}$$

$V_{RDC} = 700 \text{ V DC} / V_{TT} = 1050 \text{ V DC}, 10\text{s} / V_{TC} = 4000 \text{ V AC}, 10\text{s}$

| C_R μF | I_{MAX}^1 A | I_s kA | \hat{I} kA | ESR ² m Ω | L_{self} nH | R_{TH} K/W | D mm | H_c mm | H_T mm | Weight kg | Fig. | Ordering code |
|------------------------|------------------|-------------|-----------------|--------------------------------|------------------|-----------------|---------|-------------|-------------|--------------|------|-----------------|
| 280 | 55 | 9.1 | 3.0 | 1.4 | ≤ 40 | 4 | 85 | 70 | 76 | 0.45 | 1 | B25620B0287K701 |
| 470 | 55 | 8.6 | 2.9 | 1.6 | ≤ 40 | 3.3 | 85 | 95 | 101 | 0.58 | 1 | B25620B0477K701 |
| 560 | 80 | 18.2 | 6.0 | 1.0 | ≤ 40 | 2.9 | 116 | 70 | 76 | 0.88 | 3 | B25620B0567K703 |
| 620 | 55 | 9.1 | 3.0 | 2.0 | ≤ 40 | 2.9 | 85 | 120 | 126 | 0.71 | 1 | B25620B0627K701 |
| 700 | 55 | 9.1 | 3.0 | 2.2 | ≤ 40 | 2.8 | 85 | 132 | 138 | 0.87 | 1 | B25620B0707K701 |
| 700 | 55 | 9.1 | 3.0 | 2.2 | ≤ 40 | 2.8 | 85 | 132 | 138 | 0.87 | 2 | B25620C0707K701 |
| 750 | 70 | 16.9 | 5.6 | 1.4 | ≤ 40 | 2.4 | 85 | 155 | 161 | 1 | 1 | B25620B0757K701 |
| 900 | 80 | 18.2 | 6.0 | 1.0 | ≤ 40 | 2.3 | 116 | 95 | 101 | 1.13 | 3 | B25620B0907K703 |
| 950 | 70 | 17.6 | 5.9 | 1.5 | ≤ 60 | 2.1 | 85 | 173 | 179 | 1.1 | 1 | B25620B0957K701 |
| 1240 | 80 | 18.2 | 6.1 | 1.3 | ≤ 40 | 2.2 | 116 | 120 | 126 | 1.4 | 3 | B25620B0128K743 |
| 1300 | 70 | 17.7 | 5.9 | 1.5 | ≤ 60 | 1.9 | 85 | 223 | 229 | 1.4 | 1 | B25620B0138K701 |
| 1400 | 80 | 18.1 | 6.0 | 1.5 | ≤ 40 | 2.1 | 116 | 132 | 138 | 1.55 | 3 | B25620B0148K703 |
| 1500 | 80 | 33.8 | 11.3 | 0.9 | ≤ 40 | 2.1 | 116 | 155 | 161 | 1.75 | 3 | B25620B0158K703 |
| 1900 | 80 | 34.7 | 11.6 | 1.0 | ≤ 60 | 2 | 116 | 173 | 179 | 1.95 | 3 | B25620B0198K703 |
| 2600 | 80 | 35.5 | 11.9 | 1.1 | ≤ 60 | 1.8 | 116 | 223 | 229 | 2.56 | 3 | B25620B0268K703 |
| 3000 | 80 | 35.8 | 11.9 | 1.2 | ≤ 90 | 1.8 | 116 | 248 | 254 | 2.85 | 3 | B25620B0308K703 |
| 4000 | 100 | 40.0 | 13.3 | 1.1 | ≤ 100 | 1.4 | 116 | 345 | 351 | 4.14 | 3 | B25620B0408K703 |
| 4000 | 100 | 40.0 | 13.3 | 1.1 | ≤ 100 | 1.4 | 116 | 345 | 351 | 4.18 | 4 | B25620C0408K703 |

¹ Please refer to current derating section for more details

² ESR at 1 kHz (typical value)

Other configurations and capacitance tolerances upon request

$V_{RDC} = 900 \text{ V DC} / V_{TT} = 1350 \text{ V DC, } 10\text{s} / V_{TC} = 4000 \text{ V AC, } 10\text{s}$

| C_R μF | I_{MAX}^1 A | I_s kA | \hat{I} kA | ESR ² m Ω | L_{self} nH | R_{TH} K/W | D mm | H_c mm | H_T mm | Weight kg | Fig. | Ordering code |
|------------------------|------------------|-------------|-----------------|--------------------------------|------------------|-----------------|---------|-------------|-------------|--------------|------|-----------------|
| 220 | 50 | 8.1 | 2.7 | 1.5 | ≤ 40 | 4 | 85 | 70 | 76 | 0.45 | 1 | B25620B0227K881 |
| 220 | 50 | 8.1 | 2.7 | 1.5 | ≤ 40 | 4 | 85 | 74 | 76 | 0.48 | 2 | B25620C0227K881 |
| 350 | 50 | 8.0 | 2.7 | 1.7 | ≤ 40 | 3.3 | 85 | 95 | 101 | 0.58 | 1 | B25620B0357K881 |
| 350 | 50 | 8.0 | 2.7 | 1.7 | ≤ 40 | 3.3 | 85 | 99 | 101 | 0.61 | 2 | B25620C0357K881 |
| 440 | 65 | 16.3 | 5.4 | 1.1 | ≤ 40 | 2.9 | 116 | 70 | 76 | 0.88 | 3 | B25620B0447K883 |
| 480 | 55 | 8.1 | 2.7 | 2.1 | ≤ 40 | 2.9 | 85 | 120 | 126 | 0.71 | 1 | B25620B0487K881 |
| 480 | 55 | 8.1 | 2.7 | 2.1 | ≤ 40 | 2.9 | 85 | 124 | 126 | 0.74 | 2 | B25620C0487K881 |
| 550 | 50 | 8.3 | 2.8 | 2.3 | ≤ 40 | 2.8 | 85 | 132 | 138 | 0.87 | 1 | B25620B0557K881 |
| 550 | 50 | 8.3 | 2.8 | 2.3 | ≤ 40 | 2.8 | 85 | 136 | 138 | 0.9 | 2 | B25620C0557K881 |
| 600 | 70 | 15.5 | 5.1 | 1.5 | ≤ 40 | 2.4 | 85 | 155 | 161 | 1 | 1 | B25620B0607K881 |
| 700 | 70 | 16.1 | 5.3 | 1.2 | ≤ 40 | 2.3 | 116 | 95 | 101 | 1.13 | 3 | B25620B0707K883 |
| 750 | 75 | 17.3 | 5.8 | 1.6 | ≤ 60 | 2.1 | 85 | 173 | 179 | 1.1 | 1 | B25620B0757K881 |
| 750 | 75 | 17.3 | 5.8 | 1.6 | ≤ 60 | 2.1 | 85 | 177 | 179 | 1.13 | 2 | B25620C0757K881 |
| 900 | 75 | 14.0 | 4.7 | 1.6 | ≤ 60 | 1.9 | 85 | 223 | 229 | 1.4 | 1 | B25620B0907K881 |
| 970 | 75 | 16.3 | 5.4 | 1.4 | ≤ 40 | 2.2 | 116 | 120 | 126 | 1.4 | 3 | B25620B0977K883 |
| 1000 | 80 | 13.7 | 4.6 | 1.7 | ≤ 90 | 1.9 | 85 | 248 | 254 | 1.6 | 1 | B25620B0108K881 |
| 1100 | 80 | 16.3 | 5.4 | 1.5 | ≤ 40 | 2.1 | 116 | 132 | 138 | 1.55 | 3 | B25620B0118K883 |
| 1200 | 80 | 31.0 | 10.3 | 1.0 | ≤ 40 | 2.1 | 116 | 155 | 161 | 1.75 | 3 | B25620B0128K883 |
| 1500 | 80 | 33.1 | 11.0 | 1.1 | ≤ 60 | 2 | 116 | 173 | 179 | 1.95 | 3 | B25620B0158K883 |
| 1500 | 80 | 33.1 | 11.0 | 1.1 | ≤ 60 | 2 | 116 | 177 | 179 | 1.99 | 4 | B25620C0158K883 |
| 2000 | 80 | 33.3 | 11.0 | 1.2 | ≤ 60 | 1.8 | 116 | 223 | 229 | 2.56 | 3 | B25620B0208K883 |
| 2300 | 80 | 33.3 | 11.0 | 1.3 | ≤ 90 | 1.8 | 116 | 248 | 254 | 2.85 | 3 | B25620B0238K883 |
| 3000 | 100 | 38.5 | 12.8 | 1.2 | ≤ 100 | 1.4 | 116 | 345 | 351 | 4.14 | 3 | B25620B0308K883 |

¹ Please refer to current derating section for more details

² ESR at 1 kHz (typical value)

Other configurations and capacitance tolerances upon request

$V_{RDC} = 1100 \text{ V DC} / V_{TT} = 1650 \text{ V DC, } 10\text{s} / V_{TC} = 4000 \text{ V AC, } 10\text{s}$

| C_R μF | I_{MAX}^1 A | I_s kA | \hat{I} kA | ESR ² m Ω | L_{self} nH | R_{TH} K/W | D mm | H_c mm | H_r mm | Weight kg | Fig. | Ordering code |
|------------------------|------------------|-------------|-----------------|--------------------------------|------------------|-----------------|---------|-------------|-------------|--------------|------|------------------|
| 140 | 50 | 7.7 | 2.6 | 1.8 | ≤ 40 | 4 | 85 | 70 | 76 | 0.45 | 1 | B25620B1147K101 |
| 140 | 50 | 7.7 | 2.6 | 1.8 | ≤ 40 | 4 | 85 | 74 | 76 | 0.48 | 2 | B25620C1147K101 |
| 230 | 50 | 7.2 | 2.3 | 1.9 | ≤ 40 | 3.3 | 85 | 95 | 101 | 0.58 | 1 | B25620B1237K101 |
| 280 | 75 | 15.5 | 5.1 | 1.2 | ≤ 40 | 2.9 | 116 | 70 | 76 | 0.88 | 3 | B25620B1287K103 |
| 310 | 50 | 7.7 | 2.6 | 2.3 | ≤ 40 | 2.9 | 85 | 120 | 126 | 0.71 | 1 | B25620B1317K101 |
| 310 | 50 | 7.7 | 2.6 | 2.3 | ≤ 40 | 2.9 | 85 | 124 | 126 | 0.74 | 2 | B25620C1317K101 |
| 420 | 63 | 8.8 | 2.9 | 2.4 | ≤ 40 | 2.8 | 85 | 135 | 141 | 0.87 | 1 | B25620B1427A101* |
| 420 | 63 | 8.8 | 2.9 | 2.4 | ≤ 40 | 2.8 | 85 | 139 | 141 | 0.9 | 2 | B25620C1427A101* |
| 420 | 75 | 17.3 | 5.8 | 1.7 | ≤ 40 | 2.4 | 85 | 155 | 161 | 1 | 1 | B25620B1427K101 |
| 420 | 75 | 17.3 | 5.8 | 1.7 | ≤ 40 | 2.4 | 85 | 159 | 161 | 1.03 | 2 | B25620C1427K101 |
| 450 | 75 | 14.9 | 4.9 | 1.3 | ≤ 40 | 2.3 | 116 | 95 | 101 | 1.13 | 3 | B25620B1457K103 |
| 480 | 80 | 15.6 | 5.2 | 1.8 | ≤ 60 | 2.1 | 85 | 173 | 179 | 1.1 | 1 | B25620B1487K101 |
| 480 | 80 | 15.6 | 5.2 | 1.8 | ≤ 60 | 2.1 | 85 | 177 | 179 | 1.13 | 2 | B25620C1487K101 |
| 610 | 80 | 15.1 | 5.0 | 1.7 | ≤ 40 | 2.2 | 116 | 120 | 126 | 1.4 | 3 | B25620B1617K103 |
| 650 | 80 | 13.4 | 4.4 | 1.8 | ≤ 90 | 1.9 | 85 | 248 | 254 | 1.6 | 1 | B25620B1657K101 |
| 700 | 80 | 15.1 | 5.0 | 1.7 | ≤ 40 | 2.1 | 116 | 132 | 138 | 1.55 | 3 | B25620B1707K103 |
| 940 | 100 | 29.4 | 9.9 | 1.2 | ≤ 60 | 2 | 116 | 173 | 179 | 1.95 | 3 | B25620B1947K103 |
| 1100 | 100 | 27.7 | 9.3 | 1.3 | ≤ 100 | 1.8 | 116 | 223 | 229 | 2.56 | 3 | B25620B1118K103 |
| 1400 | 100 | 28.9 | 9.6 | 1.3 | ≤ 90 | 1.8 | 116 | 248 | 254 | 2.85 | 3 | B25620B1148K103 |
| 1500 | 100 | 29.3 | 9.7 | 1.5 | ≤ 90 | 1.7 | 116 | 273 | 279 | 3.13 | 3 | B25620B1158K103 |
| 1900 | 100 | 34.4 | 11.5 | 1.2 | ≤ 100 | 1.4 | 116 | 345 | 351 | 4.14 | 3 | B25620B1198K103 |

* Capacitance tolerance A: -15% to 0%

¹ Please refer to current derating section for more details

² ESR at 1 kHz (typical value)

Other configurations and capacitance tolerances upon request

$V_{RDC} = 1200 \text{ V DC} / V_{TT} = 1800 \text{ V DC}, 10\text{s} / V_{TC} = 4000 \text{ V AC}, 10\text{s}$

| C_R μF | I_{MAX}^1 A | I_s kA | \hat{I} kA | ESR ² m Ω | L_{self} nH | R_{TH} K/W | D mm | H_c mm | H_T mm | Weight kg | Fig. | Ordering code |
|------------------------|------------------|-------------|-----------------|--------------------------------|------------------|-----------------|---------|-------------|-------------|--------------|------|-----------------|
| 120 | 50 | 7.1 | 2.4 | 1.9 | ≤ 40 | 4 | 85 | 70 | 76 | 0.45 | 1 | B25620B1127K201 |
| 180 | 50 | 7.1 | 2.4 | 2.1 | ≤ 40 | 3.3 | 85 | 95 | 101 | 0.58 | 1 | B25620B1187K201 |
| 250 | 50 | 7.1 | 2.4 | 2.4 | ≤ 40 | 2.9 | 85 | 120 | 126 | 0.71 | 1 | B25620B1257K201 |
| 280 | 50 | 7.1 | 2.4 | 2.5 | ≤ 40 | 2.8 | 85 | 132 | 138 | 0.87 | 1 | B25620B1287K201 |
| 300 | 65 | 14.0 | 4.7 | 1.8 | ≤ 40 | 2.4 | 85 | 155 | 161 | 1 | 1 | B25620B1307K201 |
| 350 | 65 | 13.6 | 4.5 | 1.9 | ≤ 60 | 2.1 | 85 | 173 | 179 | 1.1 | 1 | B25620B1357K201 |
| 360 | 70 | 15.2 | 5.1 | 1.6 | ≤ 40 | 2.3 | 116 | 95 | 101 | 1.13 | 3 | B25620B1367K203 |
| 500 | 75 | 15.3 | 5.1 | 1.7 | ≤ 40 | 2.2 | 116 | 120 | 126 | 1.4 | 3 | B25620B1507K203 |
| 520 | 70 | 14.9 | 4.9 | 1.6 | ≤ 60 | 1.9 | 85 | 223 | 229 | 1.4 | 1 | B25620B1527K201 |
| 570 | 75 | 15.4 | 5.1 | 1.7 | ≤ 40 | 2.1 | 116 | 132 | 138 | 1.55 | 3 | B25620B1577K203 |
| 600 | 70 | 15.1 | 5.0 | 1.7 | ≤ 90 | 1.9 | 85 | 248 | 254 | 1.6 | 1 | B25620B1607K201 |
| 620 | 80 | 29.3 | 9.7 | 1.3 | ≤ 60 | 2.1 | 116 | 155 | 161 | 1.75 | 3 | B25620B1627K203 |
| 730 | 100 | 30.8 | 10.2 | 1.3 | ≤ 60 | 2 | 116 | 173 | 179 | 1.95 | 3 | B25620B1737K203 |
| 1000 | 100 | 30.7 | 10.2 | 1.4 | ≤ 90 | 1.8 | 116 | 223 | 229 | 2.56 | 3 | B25620B1108K203 |
| 1200 | 100 | 29.7 | 9.9 | 1.4 | ≤ 90 | 1.8 | 116 | 248 | 254 | 2.85 | 3 | B25620B1128K203 |
| 1600 | 100 | 36.7 | 12.3 | 1.3 | ≤ 100 | 1.4 | 116 | 345 | 351 | 4.14 | 3 | B25620B1168K203 |

¹ Please refer to current derating section for more details

² ESR at 1 kHz (typical value)

Other configurations and capacitance tolerances upon request

$V_{RDC} = 1320 \text{ V DC} / V_{TT} = 1980 \text{ V DC, 10s} / V_{TC} = 4000 \text{ V AC, 10s}$

| C_R μF | I_{MAX}^1 A | I_s kA | \hat{I} kA | ESR ² m Ω | L_{self} nH | R_{TH} K/W | D mm | H_c mm | H_T mm | Weight kg | Fig. | Ordering code |
|------------------------|------------------|-------------|-----------------|--------------------------------|------------------|-----------------|---------|-------------|-------------|--------------|------|-----------------|
| 100 | 45 | 6.6 | 2.2 | 2.2 | ≤ 40 | 4 | 85 | 70 | 76 | 0.45 | 1 | B25620B1107K321 |
| 160 | 48 | 6.8 | 2.3 | 2.3 | ≤ 40 | 3.3 | 85 | 95 | 101 | 0.58 | 1 | B25620B1167K321 |
| 220 | 45 | 7.4 | 2.5 | 2.6 | ≤ 40 | 2.9 | 85 | 120 | 126 | 0.71 | 1 | B25620B1227K321 |
| 220 | 45 | 7.4 | 2.5 | 2.6 | ≤ 40 | 2.9 | 85 | 124 | 126 | 0.74 | 2 | B25620C1227K321 |
| 260 | 45 | 7.6 | 2.6 | 2.7 | ≤ 40 | 2.8 | 85 | 132 | 138 | 0.87 | 1 | B25620B1267K321 |
| 260 | 45 | 7.6 | 2.6 | 2.7 | ≤ 40 | 2.8 | 85 | 136 | 138 | 0.9 | 2 | B25620C1267K321 |
| 310 | 65 | 14.3 | 4.8 | 1.7 | ≤ 40 | 2.3 | 116 | 95 | 101 | 1.13 | 3 | B25620B1317K323 |
| 340 | 70 | 14.8 | 5.0 | 2.1 | ≤ 60 | 2.1 | 85 | 173 | 179 | 1.1 | 1 | B25620B1347K321 |
| 340 | 70 | 14.8 | 5.0 | 2.1 | ≤ 60 | 2.1 | 85 | 177 | 179 | 1.13 | 2 | B25620C1347K321 |
| 400 | 70 | 12.4 | 4.1 | 2.2 | ≤ 90 | 1.9 | 85 | 223 | 229 | 1.4 | 1 | B25620B1407K321 |
| 420 | 65 | 14.1 | 4.7 | 1.8 | ≤ 40 | 2.2 | 116 | 120 | 126 | 1.4 | 3 | B25620B1427K323 |
| 480 | 70 | 14.1 | 4.7 | 1.8 | ≤ 40 | 2.1 | 116 | 132 | 138 | 1.55 | 3 | B25620B1487K323 |
| 500 | 70 | 13.8 | 4.6 | 2.3 | ≤ 90 | 1.9 | 85 | 248 | 254 | 1.6 | 1 | B25620B1507K321 |
| 520 | 80 | 26.9 | 8.9 | 1.4 | ≤ 40 | 2.1 | 116 | 155 | 161 | 1.75 | 3 | B25620B1527K323 |
| 660 | 100 | 27.8 | 9.3 | 1.4 | ≤ 90 | 2 | 116 | 173 | 179 | 1.95 | 3 | B25620B1667K323 |
| 880 | 100 | 27.4 | 9.1 | 1.6 | ≤ 90 | 1.8 | 116 | 223 | 229 | 2.56 | 3 | B25620B1887K323 |
| 940 | 100 | 26.9 | 8.9 | 1.6 | ≤ 90 | 1.8 | 116 | 248 | 254 | 2.85 | 3 | B25620B1947K323 |
| 1000 | 100 | 26.4 | 8.8 | 1.6 | ≤ 90 | 1.7 | 116 | 273 | 279 | 3.13 | 3 | B25620B1108K323 |
| 1300 | 100 | 36.3 | 12.1 | 1.4 | ≤ 100 | 1.4 | 116 | 345 | 351 | 4.14 | 3 | B25620B1138K323 |

¹ Please refer to current derating section for more details

² ESR at 1 kHz (typical value)

Other configurations and capacitance tolerances upon request

$V_{RDC} = 1500 \text{ V DC} / V_{TT} = 2250 \text{ V DC, 10s} / V_{TC} = 4000 \text{ V AC, 10s}$

| C_R μF | I_{MAX}^1 A | I_s kA | \hat{I} kA | ESR ² m Ω | L_{self} nH | R_{TH} K/W | D mm | H_c mm | H_T mm | Weight kg | Fig. | Ordering Code |
|------------------------|------------------|-------------|-----------------|--------------------------------|------------------|-----------------|---------|-------------|-------------|--------------|------|-----------------|
| 90 | 40 | 6.4 | 2.1 | 2.4 | ≤ 40 | 4 | 85 | 70 | 76 | 0.45 | 1 | B25620B1906K501 |
| 140 | 40 | 6.4 | 2.1 | 2.6 | ≤ 40 | 3.3 | 85 | 95 | 101 | 0.58 | 1 | B25620B1147K501 |
| 190 | 40 | 6.4 | 2.1 | 2.8 | ≤ 40 | 2.9 | 85 | 120 | 126 | 0.71 | 1 | B25620B1197K501 |
| 220 | 40 | 6.6 | 2.2 | 2.7 | ≤ 40 | 2.8 | 85 | 132 | 138 | 0.87 | 1 | B25620B1227K501 |
| 230 | 50 | 12.9 | 4.3 | 2.3 | ≤ 40 | 2.4 | 85 | 155 | 161 | 1 | 1 | B25620B1237K501 |
| 270 | 50 | 12.4 | 4.1 | 1.8 | ≤ 40 | 2.3 | 116 | 95 | 101 | 1.13 | 3 | B25620B1277K503 |
| 280 | 50 | 12.9 | 4.3 | 2.3 | ≤ 60 | 2.1 | 85 | 173 | 179 | 1.1 | 1 | B25620B1287K501 |
| 370 | 50 | 12.5 | 4.2 | 2.3 | ≤ 40 | 2.2 | 116 | 120 | 126 | 1.4 | 3 | B25620B1377K503 |
| 380 | 70 | 12.8 | 4.3 | 2.5 | ≤ 60 | 1.9 | 85 | 223 | 229 | 1.4 | 1 | B25620B1387K501 |
| 420 | 50 | 12.5 | 4.2 | 2.3 | ≤ 40 | 2.1 | 116 | 132 | 139 | 1.55 | 3 | B25620B1427K503 |
| 440 | 70 | 13.1 | 4.4 | 2.6 | ≤ 90 | 1.9 | 85 | 248 | 254 | 1.6 | 1 | B25620B1447K501 |
| 450 | 60 | 25.2 | 8.4 | 1.7 | ≤ 60 | 2.1 | 116 | 155 | 161 | 1.75 | 3 | B25620B1457K503 |
| 550 | 60 | 25.2 | 8.4 | 1.6 | ≤ 60 | 2 | 116 | 173 | 179 | 1.95 | 3 | B25620B1557K503 |
| 740 | 80 | 25.0 | 8.3 | 1.8 | ≤ 90 | 1.8 | 116 | 223 | 229 | 2.56 | 3 | B25620B1747K503 |
| 840 | 80 | 25.1 | 8.4 | 1.8 | ≤ 90 | 1.8 | 116 | 248 | 254 | 2.85 | 3 | B25620B1847K503 |
| 1100 | 100 | 33.3 | 11.1 | 1.5 | ≤ 100 | 1.4 | 116 | 345 | 351 | 4.14 | 3 | B25620B1118K503 |

¹ Please refer to current derating section for more details

² ESR at 1 kHz (typical value)

Other configurations and capacitance tolerances upon request

$V_{RDC} = 2000 \text{ V DC} / V_{TT} = 3000 \text{ V DC}, 10\text{s} / V_{TC} = 4000 \text{ V AC}, 10\text{s}$

| C_R μF | I_{MAX}^1 A | I_s kA | \hat{I} kA | ESR ² m Ω | L_{self} nH | R_{TH} K/W | D mm | H _c mm | H _T mm | Weight kg | Fig. | Ordering Code |
|------------------------|------------------|-------------|-----------------|--------------------------------|------------------|-----------------|---------|----------------------|----------------------|--------------|------|-----------------|
| 40 | 35 | 4.5 | 1.5 | 3.3 | ≤ 60 | 4 | 85 | 70 | 76 | 0.45 | 1 | B25620B1406K981 |
| 40 | 35 | 4.5 | 1.5 | 3.3 | ≤ 60 | 4 | 85 | 74 | 76 | 0.48 | 2 | B25620C1406K981 |
| 70 | 40 | 4.9 | 1.6 | 3.5 | ≤ 60 | 3.3 | 85 | 95 | 101 | 0.58 | 1 | B25620B1706K981 |
| 70 | 40 | 4.9 | 1.6 | 3.5 | ≤ 60 | 3.3 | 85 | 99 | 101 | 0.61 | 2 | B25620C1706K981 |
| 100 | 40 | 4.9 | 1.6 | 3.6 | ≤ 60 | 2.9 | 85 | 120 | 126 | 0.71 | 1 | B25620B1107K981 |
| 110 | 40 | 4.6 | 1.5 | 3.6 | ≤ 60 | 2.8 | 85 | 132 | 138 | 0.87 | 1 | B25620B1117K981 |
| 145 | 50 | 10.0 | 3.4 | 2.7 | ≤ 60 | 2.1 | 85 | 173 | 179 | 1.1 | 1 | B25620B1147K981 |
| 145 | 50 | 10.0 | 3.4 | 2.7 | ≤ 60 | 2.1 | 85 | 177 | 179 | 1.13 | 2 | B25620C1147K981 |
| 190 | 60 | 9.6 | 3.2 | 2.8 | ≤ 60 | 2.2 | 116 | 120 | 126 | 1.4 | 3 | B25620B1197K983 |
| 200 | 70 | 9.3 | 3.1 | 2.8 | ≤ 90 | 1.9 | 85 | 223 | 229 | 1.4 | 1 | B25620B1207K981 |
| 215 | 60 | 9.6 | 3.2 | 2.9 | ≤ 40 | 2.1 | 116 | 132 | 138 | 1.55 | 3 | B25620B1217K983 |
| 220 | 70 | 9.0 | 3.0 | 2.8 | ≤ 90 | 1.9 | 85 | 248 | 254 | 1.6 | 1 | B25620B1227K981 |
| 230 | 80 | 17.8 | 5.9 | 1.8 | ≤ 40 | 2.1 | 116 | 155 | 161 | 1.75 | 3 | B25620B1237K983 |
| 295 | 80 | 18.8 | 6.3 | 1.9 | ≤ 60 | 2 | 116 | 173 | 179 | 1.95 | 3 | B25620B1297K983 |
| 380 | 80 | 17.8 | 5.9 | 2.2 | ≤ 90 | 1.8 | 116 | 223 | 229 | 2.56 | 3 | B25620B1387K983 |
| 440 | 80 | 18.2 | 6.1 | 2.5 | ≤ 90 | 1.8 | 116 | 248 | 254 | 2.85 | 3 | B25620B1447K983 |
| 460 | 100 | 18.2 | 6.0 | 2.8 | ≤ 90 | 1.7 | 116 | 263 | 269 | 3.0 | 3 | B25620B1467K983 |
| 510 | 100 | 19.3 | 6.4 | 3 | ≤ 90 | 1.7 | 116 | 273 | 279 | 3.13 | 3 | B25620B1517K983 |
| 600 | 100 | 25.1 | 8.4 | 2.2 | ≤ 100 | 1.4 | 116 | 345 | 351 | 4.14 | 3 | B25620B1607K983 |

¹ Please refer to current derating section for more details

² ESR at 1 kHz (typical value)

Other configurations and capacitance tolerances upon request

Display of ordering codes for EPCOS products

The ordering code for one and the same EPCOS product can be represented differently in data sheets, data books, other publications, on the EPCOS website, or in order-related documents such as shipping notes, order confirmations and product labels. The varying representations of the ordering codes are due to different processes employed and do not affect the specifications of the respective products. Detailed information can be found on the Internet under www.epcos.com/orderingcodes

2. Current derating

2.1 Current derating graphs for capacitors 700 V_{RDC}

B25620B0287K701



B25620B0477K701

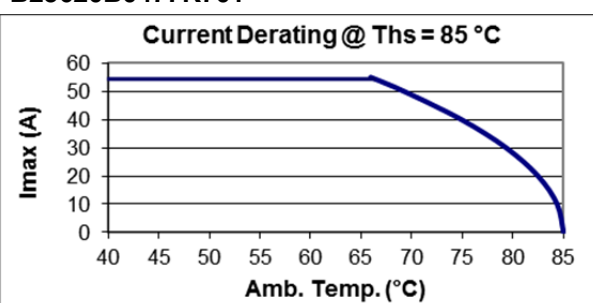

B25620B0567K703

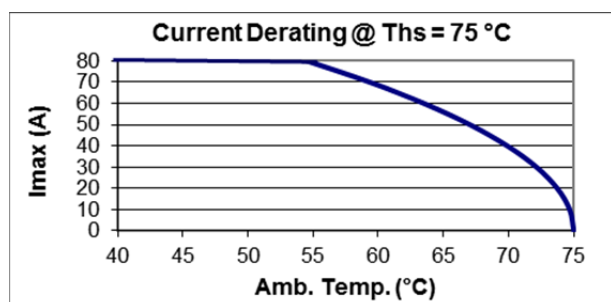

B25620B0627K701

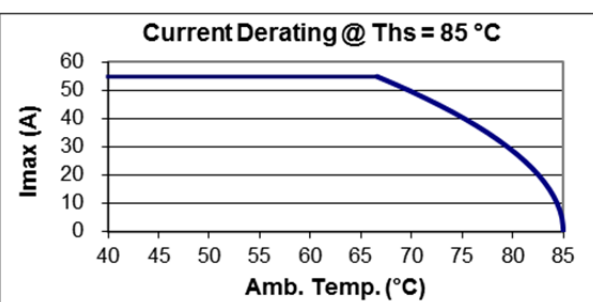

B25620B0707K701/ B25620C0707K701

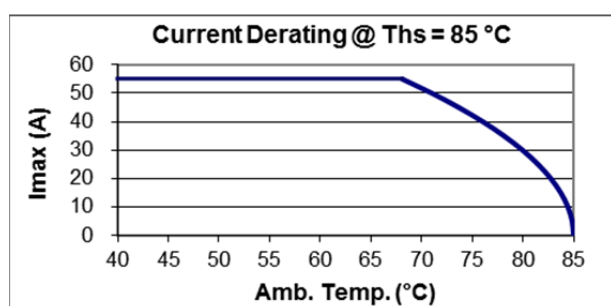

B25620B0757K701

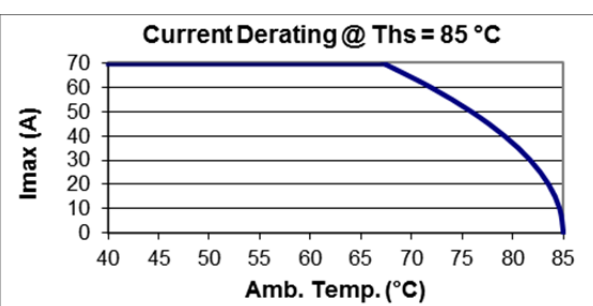

B25620B0907K703

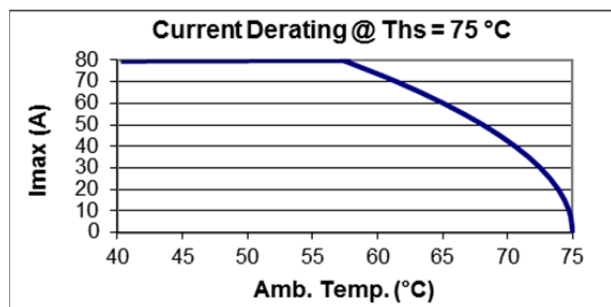

B25620B0957K701

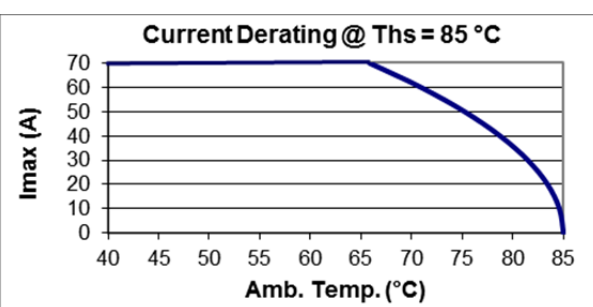

B25620B0128K743



B25620B0138K701



B25620B0148K703



B25620B0158K703



B25620B0198K703



B25620B0268K703



B25620B0308K703



B25620B0408K703/ B25620C0408K703

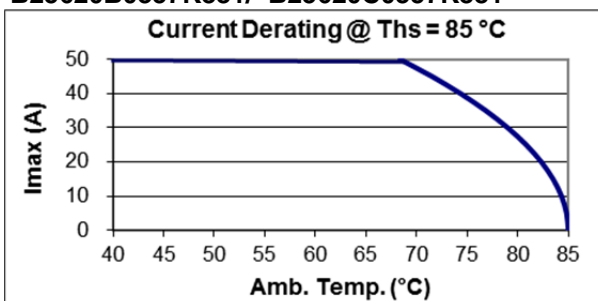

2.2 Current derating graphs for capacitors 900 V_{RDC}
B25620B0227K881/ B25620C0227K881

B25620B0357K881/ B25620C0357K881

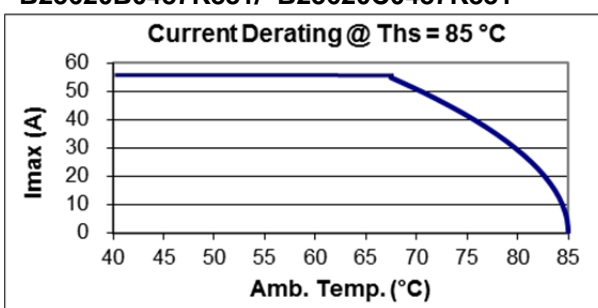
B25620B0447K883

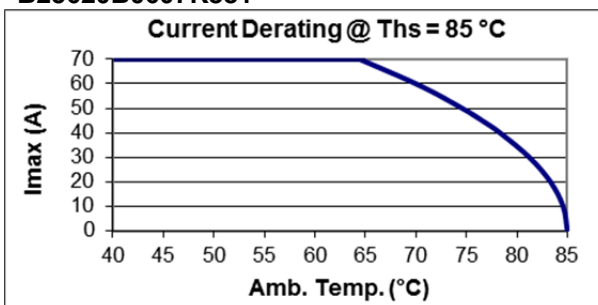
B25620B0487K881/ B25620C0487K881

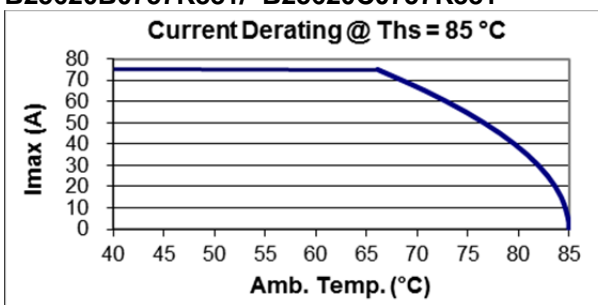
B25620B0557K881/ B25620C0557K881

B25620B0607K881

B25620B0707K883

B25620B0757K881/ B25620C0757K881

B25620B0907K881

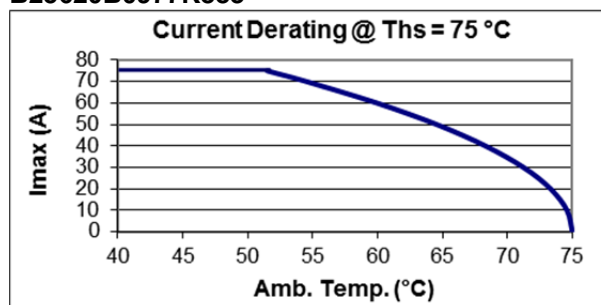

B25620B0977K883



B25620B0108K881



B25620B0118K883

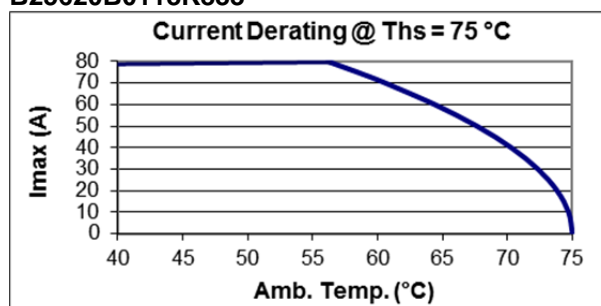

B25620B0128K883

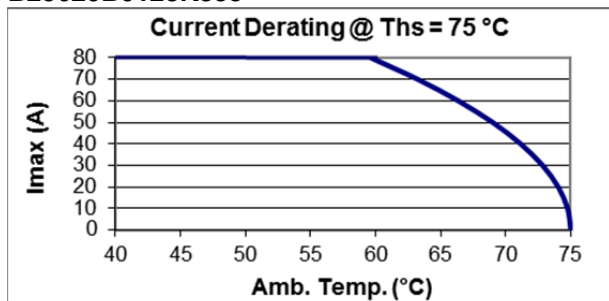

B25620B0158K883/ B25620C0158K883

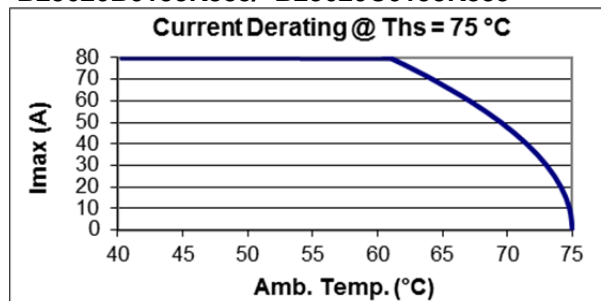

B25620B0208K883

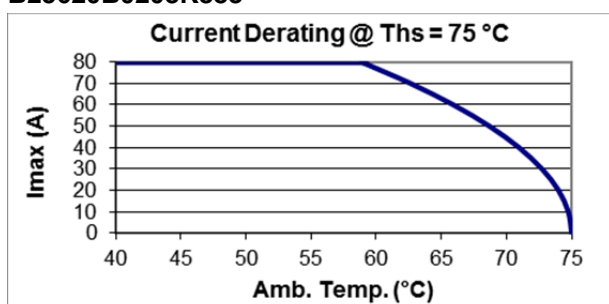

B25620B0238K883

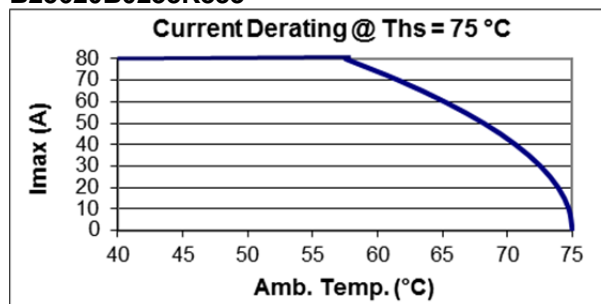

B25620B0308K883

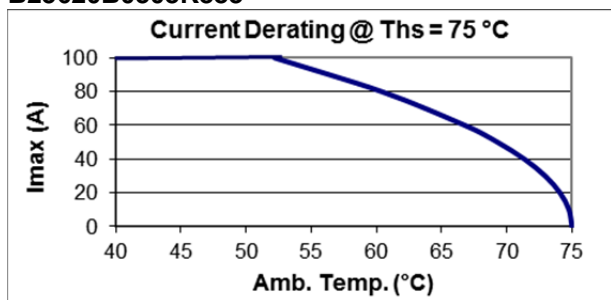

2.3 Current derating graphs for capacitors 1100 V_{RDC}

B25620B1147K101/ B25620C1147K101

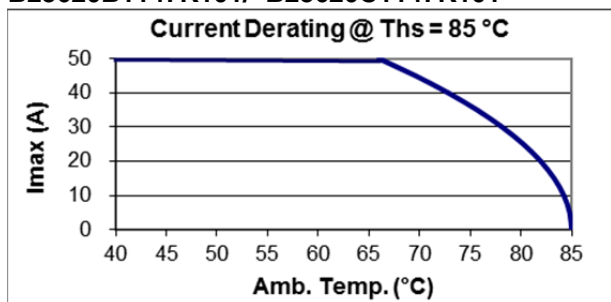

B25620B1237K101

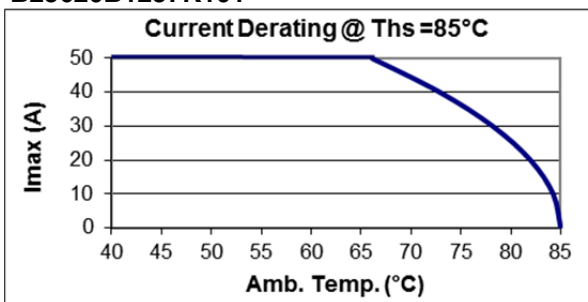

B25620B1287K103

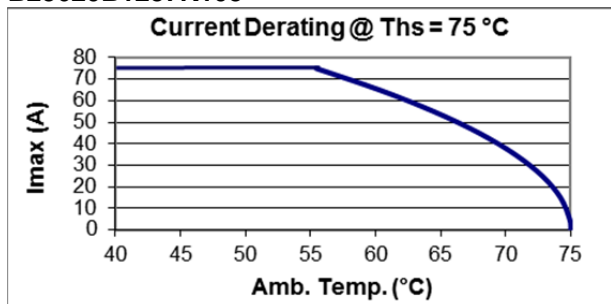

B25620B1317K101/ B25620C1317K101

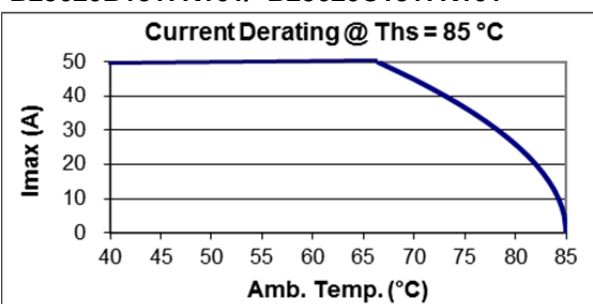

B25620B1427A101/ B25620C1427A101

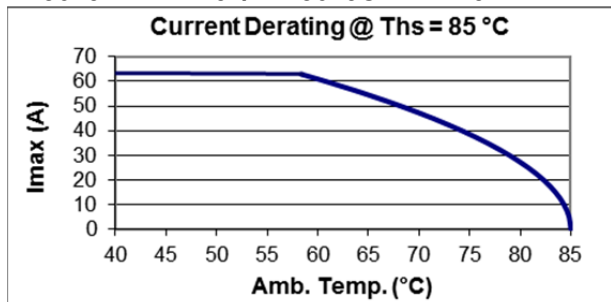

B25620B1427K101/ B25620C1427K101

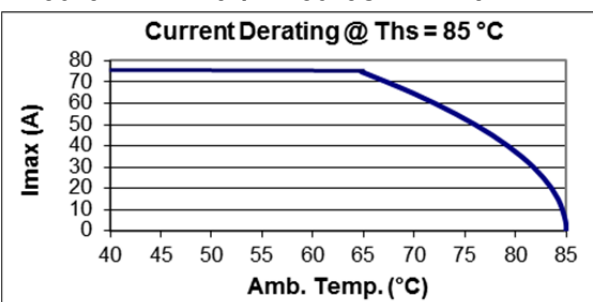

B25620B1457K103



B25620B1487K101/ B25620C1487K101



B25620B1617K103



B25620B1657K101



B25620B1707K103

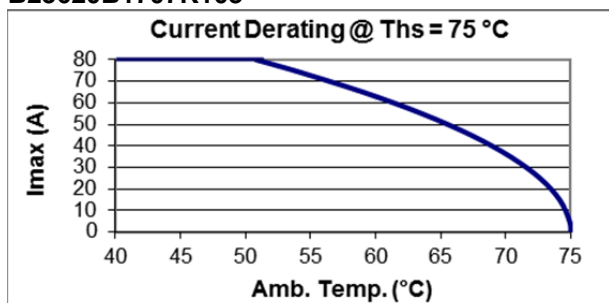

B25620B1947K103

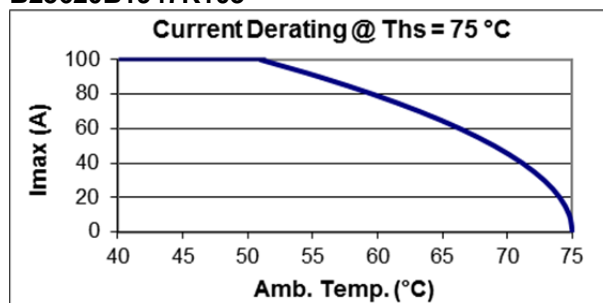

B25620B1118K103

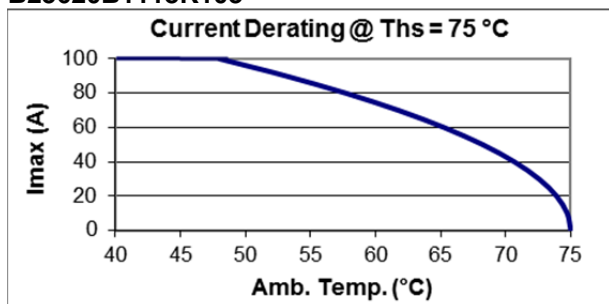

B25620B1148K103

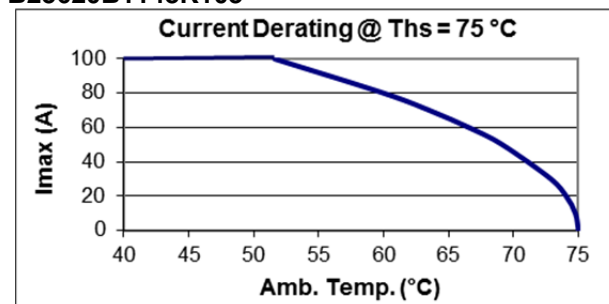

B25620B1158K103



B25620B1198K103



2.4 Current derating graphs for capacitors 1200 V_{RDC}

B25620B1127K201



B25620B1187K201



B25620B1257K201



B25620B1287K201



B25620B1307K201

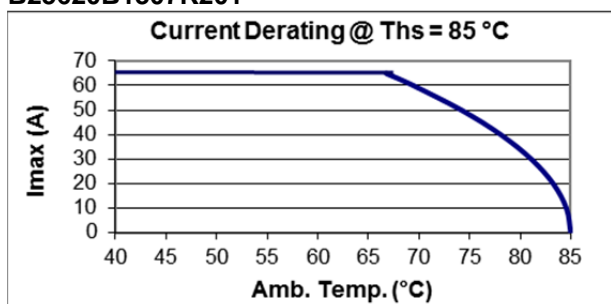

B25620B1357K201

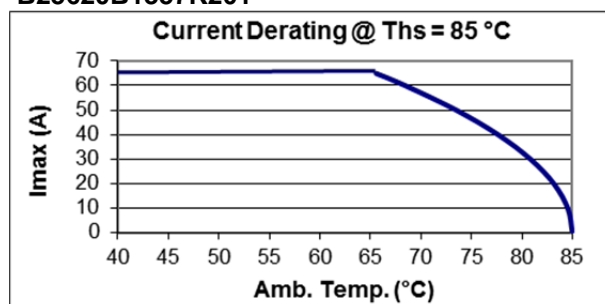

B25620B1367K203



B25620B1507K203



B25620B1527K201



B25620B1577K203



B25620B1607K201



B25620B1627K203



B25620B1737K203



B25620B1108K203



B25620B1128K203



B25620B1168K203



Current derating graphs are based on typical values. Graphs for capacitors rated 1320 / 1500/2000 U_{NDC} are available upon request.

3. Service life



Service life t_{LD} at different hotspot temperature (Θ_{hs}) and voltage V

For capacitors with diameter 116 mm a maximum hot spot temperature of +85 °C is allowed during short term operation (maximum 10% of the total load duration) without further reduction of the service life.

The expected lifetime is a calculated value based on real application data and life endurance test for this capacitor series. The lifetime calculation correlates the time of test, voltage and temperature always comparing testing conditions to real application data and its own ageing factors. In order to determine the ageing factor used for this capacitor design it was performed life endurance tests with different stress is voltage and temperature. Failure criteria is capacitance drop higher than 3%.

4. FIT



The FIT (Failure In Time) of a component is defined as the number of expected failures in 10⁹ hours of operation. The FIT rate is calculated on the basis of the number of components operating in the field and the estimated hours of operation. All the reports of failures are taken into consideration for this calculation, which is updated every year.

The other values in the graph are given as indication and calculated based on acceleration factors.

Cautions and warnings

- In case of dents of more than 1 mm depth or any other mechanical damage, capacitors must not be used at all.
- Check tightness of the connections/terminals periodically.
- The energy stored in capacitors may be lethal. To prevent any chance of shock, discharge and short-circuit the capacitor before handling.
- Failure to follow cautions may result, worst case, in premature failures, bursting and fire.
- EPCOS AG is not responsible for any kind of possible damages to persons or things due to improper installation and application of capacitors for power electronics.

Safety

- Electrical or mechanical misapplication of capacitors may be hazardous. Personal injury or property damage may result from bursting of the capacitor or from expulsion of oil or melted material due to mechanical disruption of the capacitor.
- Ensure good, effective grounding for capacitor enclosures.
- Observe appropriate safety precautions during operation (self-recharging phenomena and the high energy contained in capacitors).
- Handle capacitors carefully, because they may still be charged even after disconnection.
- The terminals of capacitors, connected bus bars and cables as well as other devices may also be energized.
- Follow good engineering practice.

Thermal load

After installation of the capacitor it is necessary to verify that maximum hot-spot temperature is not exceeded at extreme service conditions.

Mechanical protection

The capacitor has to be installed in a way that mechanical damages and dents in the aluminum can are avoided.

Storage and operating conditions

Do not use or store capacitors in corrosive atmosphere, especially where chloride gas, sulfide gas, acid, alkali, salt or the like are present. In dusty environments regular maintenance and cleaning especially of the terminals is required to avoid conductive path between phases and/or phases and ground.

The maximum storage temperature is +85 °C.

Service life expectancy

Electrical components do not have an unlimited service life expectancy; this applies to self-healing capacitors, too. The maximum service life expectancy may vary depending on the application the capacitor is used in.

Important notes

The following applies to all products named in this publication:

1. Some parts of this publication contain **statements about the suitability of our products for certain areas of application**. These statements are based on our knowledge of typical requirements that are often placed on our products in the areas of application concerned. We nevertheless expressly point out **that such statements cannot be regarded as binding statements about the suitability of our products for a particular customer application**. As a rule, EPCOS is either unfamiliar with individual customer applications or less familiar with them than the customers themselves. For these reasons, it is always ultimately incumbent on the customer to check and decide whether an EPCOS product with the properties described in the product specification is suitable for use in a particular customer application.
2. We also point out that **in individual cases, a malfunction of electronic components or failure before the end of their usual service life cannot be completely ruled out in the current state of the art, even if they are operated as specified**. In customer applications requiring a very high level of operational safety and especially in customer applications in which the malfunction or failure of an electronic component could endanger human life or health (e.g. in accident prevention or life-saving systems), it must therefore be ensured by means of suitable design of the customer application or other action taken by the customer (e.g. installation of protective circuitry or redundancy) that no injury or damage is sustained by third parties in the event of malfunction or failure of an electronic component.
3. **The warnings, cautions and product-specific notes must be observed.**
4. In order to satisfy certain technical requirements, **some of the products described in this publication may contain substances subject to restrictions in certain jurisdictions (e.g. because they are classed as hazardous)**. Useful information on this will be found in our Material Data Sheets on the Internet (www.epcos.com/material). Should you have any more detailed questions, please contact our sales offices.
5. We constantly strive to improve our products. Consequently, **the products described in this publication may change from time to time**. The same is true of the corresponding product specifications. Please check therefore to what extent product descriptions and specifications contained in this publication are still applicable before or when you place an order. We also **reserve the right to discontinue production and delivery of products**. Consequently, we cannot guarantee that all products named in this publication will always be available. The aforementioned does not apply in the case of individual agreements deviating from the foregoing for customer-specific products.
6. Unless otherwise agreed in individual contracts, **all orders are subject to the current version of the "General Terms of Delivery for Products and Services in the Electrical Industry" published by the German Electrical and Electronics Industry Association (ZVEI)**.
7. **Our manufacturing sites serving the automotive business apply the IATF 16949 standard**. The IATF certifications confirm our compliance with requirements regarding the quality management system in the automotive industry. Referring to customer requirements and customer specific requirements ("CSR") TDK always has and will continue to have the policy of respecting individual agreements. Even if IATF 16949 may appear to support the acceptance of unilateral requirements, we hereby like to emphasize that **only requirements mutually agreed upon can and will be implemented in our Quality Management System**. For clarification purposes we like to point out that obligations from IATF 16949 shall only become legally binding if individually agreed upon.

Important notes

8. The trade names EPCOS, CeraCharge, CeraDiode, CeraLink, CeraPad, CeraPlas, CSMP, CTVS, DeltaCap, DigiSiMic, ExoCore, FilterCap, FormFit, LeaXield, MiniBlue, MiniCell, MKD, MKK, MotorCap, PCC, PhaseCap, PhaseCube, PhaseMod, PhiCap, PowerHap, PQSine, PQvar, SIFERRIT, SIFI, SIKOREL, SilverCap, SIMDAD, SiMic, SIMID, SineFormer, SIOV, ThermoFuse, WindCap are **trademarks registered or pending** in Europe and in other countries. Further information will be found on the Internet at www.epcos.com/trademarks.

Release 2018-06

Mouser Electronics

Authorized Distributor

Click to View Pricing, Inventory, Delivery & Lifecycle Information:

EPCOS / TDK:

[B25620B1118K103](#) [B25620B1147K101](#) [B25620B1167K321](#) [B25620B1227K321](#) [B25620B1237K101](#)
[B25620B1347K321](#) [B25620B1406K981](#) [B25620B1487K101](#) [B25620B1706K981](#) [B25620B1117K981](#)
[B25620B1427A101](#) [B25620B1147K981](#) [B25620B1267K321](#) [B25620B1317K101](#) [B25620C1427A101](#)
[B25620B0227K881](#) [B25620B0487K881](#) [B25620B0557K881](#) [B25620B0357K881](#) [B25620B0757K881](#)
[B25620B1108K203](#) [B25620B1667K323](#) [B25620B1487K323](#) [B25620C1347K321](#) [B25620B0977K883](#)
[B25620B1427K323](#) [B25620B1457K103](#) [B25620B1577K203](#) [B25620B0707K883](#) [B25620B1707K103](#)
[B25620B1947K103](#) [B25620B1297K983](#) [B25620B0118K883](#) [B25620B1317K323](#) [B25620B0128K743](#)
[B25620B0158K883](#) [B25620B0627K701](#) [B25620B1158K103](#) [B25620B0287K701](#) [B25620C0757K881](#)
[B25620B0707K701](#) [B25620C1406K981](#) [B25620B1737K203](#) [B25620B1517K983](#) [B25620B0447K883](#)
[B25620C1487K101](#) [B25620B1108K323](#) [B25620C1267K321](#) [B25620B0148K703](#) [B25620B1197K983](#)
[B25620B0567K703](#) [B25620C1427K101](#) [B25620B1217K983](#) [B25620B1427K101](#) [B25620B1617K103](#)
[B25620C0158K883](#) [B25620C1706K981](#) [B25620B1467K983](#) [B25620B1367K203](#)



Компания «ЭлектроПласт» предлагает заключение долгосрочных отношений при поставках импортных электронных компонентов на взаимовыгодных условиях!

Наши преимущества:

- Оперативные поставки широкого спектра электронных компонентов отечественного и импортного производства напрямую от производителей и с крупнейших мировых складов;
- Поставка более 17-ти миллионов наименований электронных компонентов;
- Поставка сложных, дефицитных, либо снятых с производства позиций;
- Оперативные сроки поставки под заказ (от 5 рабочих дней);
- Экспресс доставка в любую точку России;
- Техническая поддержка проекта, помощь в подборе аналогов, поставка прототипов;
- Система менеджмента качества сертифицирована по Международному стандарту ISO 9001;
- Лицензия ФСБ на осуществление работ с использованием сведений, составляющих государственную тайну;
- Поставка специализированных компонентов (Xilinx, Altera, Analog Devices, Intersil, Interpoint, Microsemi, Aeroflex, Peregrine, Syfer, Eurofarad, Texas Instrument, Miteq, Cobham, E2V, MA-COM, Hittite, Mini-Circuits, General Dynamics и др.);

Помимо этого, одним из направлений компании «ЭлектроПласт» является направление «Источники питания». Мы предлагаем Вам помощь Конструкторского отдела:

- Подбор оптимального решения, техническое обоснование при выборе компонента;
- Подбор аналогов;
- Консультации по применению компонента;
- Поставка образцов и прототипов;
- Техническая поддержка проекта;
- Защита от снятия компонента с производства.



Как с нами связаться

Телефон: 8 (812) 309 58 32 (многоканальный)

Факс: 8 (812) 320-02-42

Электронная почта: org@eplast1.ru

Адрес: 198099, г. Санкт-Петербург, ул. Калинина, дом 2, корпус 4, литера А.