



## Film Capacitors

### Power Electronic Capacitors

**Series/Type:** MKP DC  
**Ordering code:** B2562\*  
Date: May 2018  
Version: 12

© EPCOS AG 2018. Reproduction, publication and dissemination of this publication, enclosures hereto and the information contained therein without EPCOS' prior express consent is prohibited.

EPCOS AG is a TDK Group Company.

## Construction

### 1. Construction and general data

Characteristics	
Standard capacitance tolerance	K: $\pm 10\%$
Dielectric dissipation factor ( $\tan \delta_o$ )	$2 \cdot 10^{-4}$
Loss factor ( $\tan \delta$ ) at 100 Hz	$\leq 1.2 \cdot 10^{-3}$ for $C_R < 450 \mu\text{F}$ $\leq 1.5 \cdot 10^{-3}$ for $450 \mu\text{F} \leq C_R \leq 800 \mu\text{F}$ $\leq 2.0 \cdot 10^{-3}$ for $C_R > 800 \mu\text{F}$
Service life expectancy (refer to section 3)	100 000 h at $\Theta_{\text{hs}} +75 \text{ }^\circ\text{C}$ und $V_{\text{RDC}}$ up to 200 000 h (Considering de-ratings in voltage and/or temperature (upon request))
Fit rate	50 at $V_{\text{RDC}}$ and $+70 \text{ }^\circ\text{C}$ (refer to section 4)
Minimum temperature $\Theta_{\text{min.}}$	$-55 \text{ }^\circ\text{C}$
Maximum temperature $\Theta_{\text{max.}}$	$+85 \text{ }^\circ\text{C}$ for diameter 85 mm $+75 \text{ }^\circ\text{C}$ for diameter 116 mm
Storage temperature $\Theta_{\text{stg}}$	$-55 \dots +85 \text{ }^\circ\text{C}$
Maximum hotspot temperature $\Theta_{\text{hs}}$ (refer to section 1)	$+85 \text{ }^\circ\text{C}$ for diameter 85 mm $+75 \text{ }^\circ\text{C}$ for diameter 116 mm
Climatic category	55/85/56 for 85 mm diameter 55/75/56 for 116 mm diameter
Maximum altitude	2000 m above sea level (derating curves available upon request)
Frequency range	100 Hz to 10 kHz (High frequency designs available upon request)

Test data	
Voltage between terminals $V_{\text{TT}}$	$1.5 V_{\text{RDC}}$ , 10 s
Voltage between terminals and case $U_{\text{TC}}$	4000 V AC, 10 s
Life test	According to IEC 61071
Cooling	Naturally air-cooled (or forced air cooling)
Degree of protection	Indoor mounting

Design data	
Resin filling	Non PCB, hard polyurethane (dry type)
Mounting and grounding	M12 threaded bolt on bottom of the aluminum case
Max. torque (case) M12 stud	10 Nm
Max. torque terminal	Female M6: 5 Nm Female M8: 6 Nm Male M8: 8 Nm

Reference standards	
IEC 61071	
RoHS compliance	
Certification: UL 810-5th edition (refer to table 1.3)	

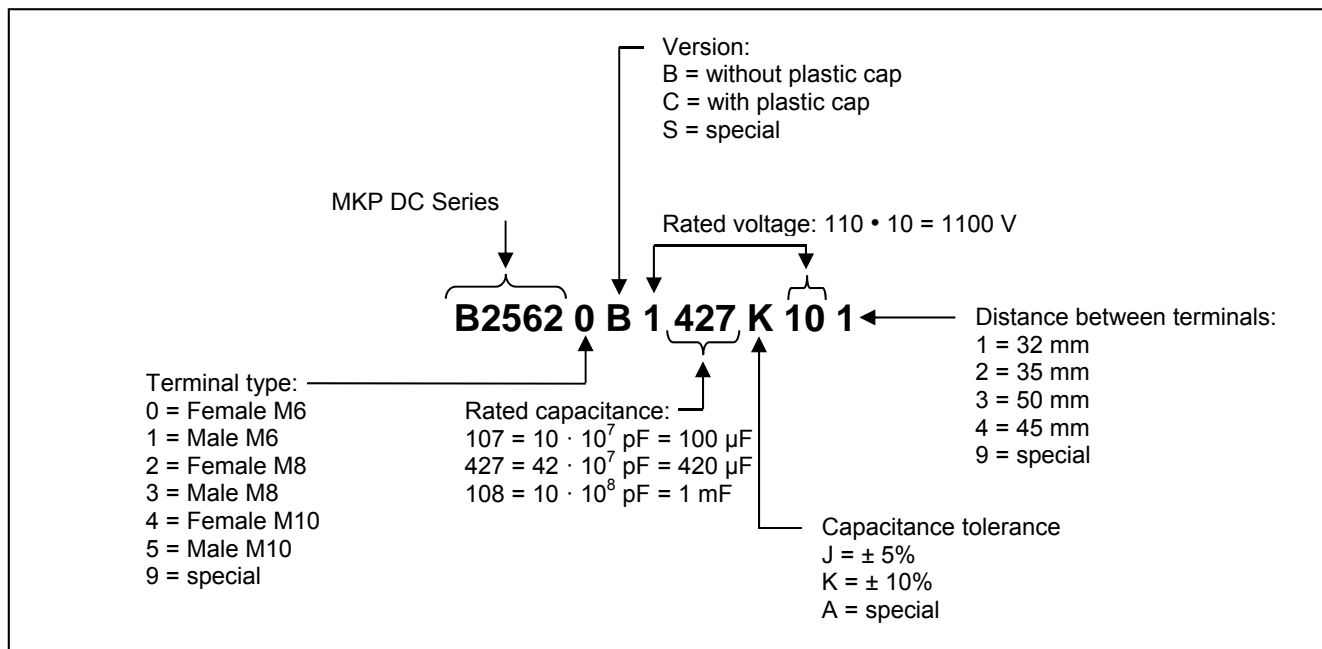
**1.1 Structure of ordering code**

**1.2 Standard types**

Diameter (Ø) Terminal type		D (mm) OC ending	$32 \pm 0.5$ -**1	$50 \pm 0.5$ -**3
		85 mm	Female M6 (B25620)	standard
116 mm	Female M6 (B25620)		standard	

Other terminal configurations upon request.

**1.3 UL approved types**

Diameter (Ø)	Series
85 mm	B2562xC
116 mm	Hc = 70 to 290 mm approved Hc = 290 to 345 mm under approval

**1.4 Drawings**

Figure 1: - B25620B - Ø 85mm  
 - Female terminals (M6)  
 - Between terminals  $32 \pm 0.5\text{mm}$

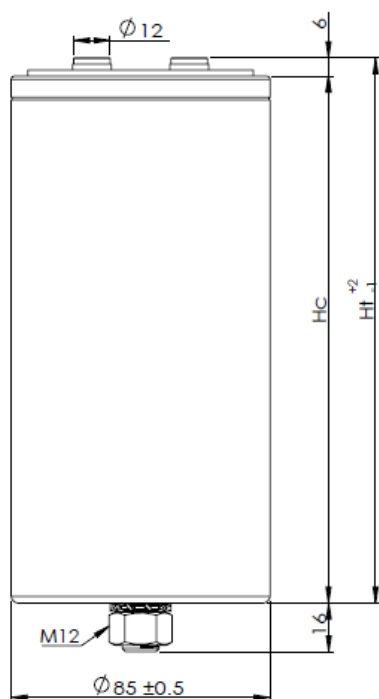

Figure 2: - B25620C - Ø 85mm  
 - Female terminals (M6)  
 - Between terminals  $32 \pm 0.5\text{mm}$

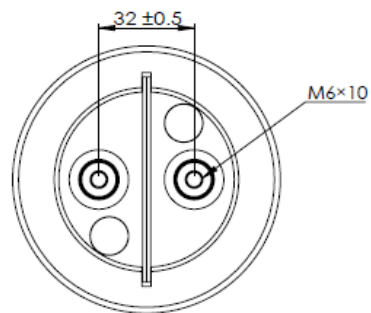
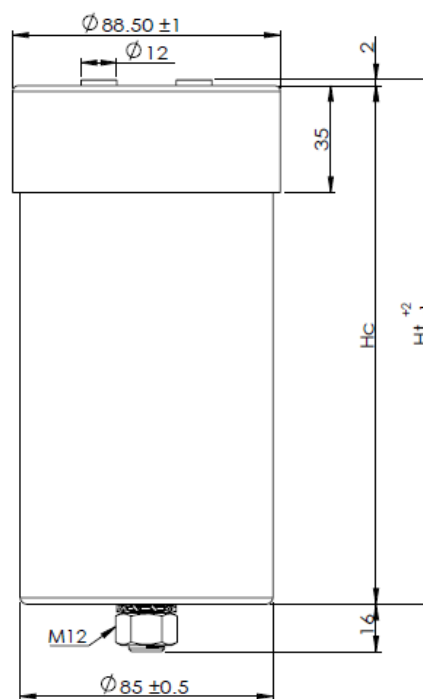
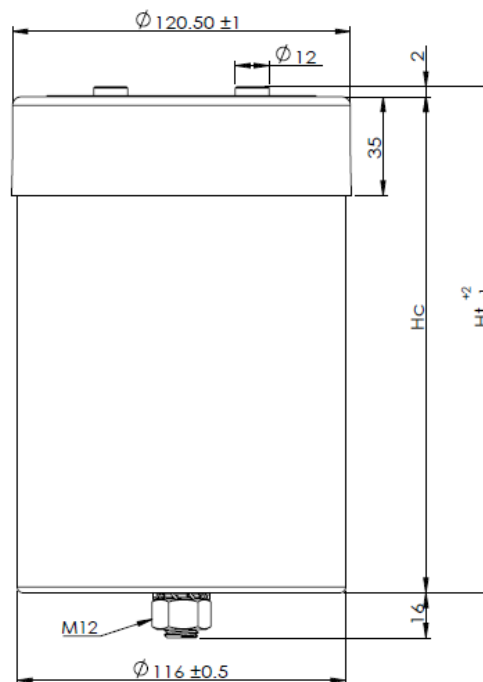

Figure 3: - B25620B -  $\varnothing$  116mm  
 - Female terminals (M6)  
 - Between terminals  $50 \pm 0.5$ mm



Figure 4: - B25620C -  $\varnothing$  116mm  
 - Female terminals (M6)  
 - Between terminals  $50 \pm 0.5$ mm



M12 stud on bottom of the aluminum case, nut and washer for fixing are standard for all types.

### Terms and characteristics

The following definitions apply to power capacitors according to IEC 61071.

#### **Rated capacitance $C_R$**

Nominal value of the capacitance at +20 °C and measuring frequency range of 50 to 120 Hz.

#### **Rated DC voltage $V_{RDC}$**

Maximum operating peak voltage of either polarity but of a non-reversing type wave form, for which the capacitor has been designed, for continuous operation.

#### **Ripple voltage $V_r$**

Peak-to-peak alternating component of the unidirectional voltage.

This value must not exceed  $0.28 \cdot V_{RDC}$

#### **Maximum surge voltage $V_s$**

Peak voltage induced by a switching or any other disturbance of the system which is allowed for a limited number of times and short period.

#### **Insulation voltage $V_i$**

RMS rated value of the insulation voltage of capacitive elements and terminals to case or earth. When it is not specified in the product data sheet, the insulation voltage is at least:

$$V_i = \frac{V_R}{\sqrt{2}}$$

#### **Maximum rate of voltage rise $(du/dt)_{max}$**

Maximum permissible repetitive rate of voltage rise of the operational voltage.

#### **Maximum current $I_{max}$**

Maximum RMS current for continuous operation for the given frequency range and for the maximum ripple voltage. Please provide Frequency Spectrum of RMS current to your sales contact.

#### **Maximum peak current $\hat{I}$**

Maximum permissible repetitive current amplitude during continuous operation.

Maximum peak current ( $\hat{I}$ ) and maximum rate of voltage rise  $(du/dt)_{max}$  on a capacitor are related as follows:

$$\hat{I} = C \cdot (dv/dt)_{max}$$

#### **Maximum surge current $\hat{I}_s$**

Admissible peak current induced by a switching or any other disturbance of the system which is allowed for a limited number of times and short period.

$$\hat{I}_s = C \cdot (dv/dt)_s$$

#### **Ambient temperature $\Theta_A$**

Temperature of the surrounding air, measured at 10 cm distance and 2/3 of the case height of the capacitor.

#### **Lowest operating temperature $\Theta_{min}$**

Lowest permitted ambient temperature at which a capacitor may be energized.

**Maximum operating temperature  $\Theta_{max}$** 

Highest permitted capacitor temperature during operation, i.e. temperature at the hottest point of the case.

**Hot-spot temperature  $\Theta_{hs}$** 

Temperature zone inside of the capacitor at hottest spot.

$$\Theta_{hs} = T_{amb} + I_{RMS}^2 \cdot ESR \cdot R_{th}$$

**Tangent of the loss angle of a capacitor  $\tan \delta$** 

Ratio between the equivalent series resistance and the capacitive reactance of a capacitor at a specified sinusoidal alternating voltage, frequency and temperature.

**Series resistance  $R_s$** 

The sum of all ohmic resistances occurring inside the capacitor.

**ESR**

ESR (Equivalent Series Resistance) representing entire active power in capacitor.

$$ESR = \frac{\tan \delta}{\omega \cdot C} = R_s + \frac{\tan \delta_0}{\omega \cdot C}$$

**Thermal resistance  $R_{th}$** 

The thermal resistance indicates by how many degrees the capacitor temperature at the hot spot rises in relation to the dissipation losses.

**Maximum power loss  $P_{max}$** 

Maximum permissible power dissipation for the capacitor's operation.

$$P_{max} = \frac{\Theta_{hs} - \Theta_A}{R_{th}}$$

**Self inductance  $L_{self}$** 

The sum of all inductive elements which are contained in a capacitor.

**Resonance frequency  $f_r$** 

The lowest frequency at which the impedance of the capacitor becomes minimum.

$$f_r = \frac{1}{2\pi \cdot \sqrt{L_{self} \cdot C_R}}$$

**$V_{RDC} = 700 \text{ V DC} / V_{TT} = 1050 \text{ V DC}, 10\text{s} / V_{TC} = 4000 \text{ V AC}, 10\text{s}$** 

$C_R$ $\mu\text{F}$	$I_{MAX}^1$ A	$I_s$ kA	$\hat{I}$ kA	ESR <sup>2</sup> m $\Omega$	$L_{self}$ nH	$R_{TH}$ K/W	D mm	$H_c$ mm	$H_T$ mm	Weight kg	Fig.	Ordering code
280	55	9.1	3.0	1.4	≤ 40	4	85	70	76	0.45	1	B25620B0287K701
470	55	8.6	2.9	1.6	≤ 40	3.3	85	95	101	0.58	1	B25620B0477K701
560	80	18.2	6.0	1.0	≤ 40	2.9	116	70	76	0.88	3	B25620B0567K703
620	55	9.1	3.0	2.0	≤ 40	2.9	85	120	126	0.71	1	B25620B0627K701
700	55	9.1	3.0	2.2	≤ 40	2.8	85	132	138	0.87	1	B25620B0707K701
700	55	9.1	3.0	2.2	≤ 40	2.8	85	132	138	0.87	2	B25620C0707K701
750	70	16.9	5.6	1.4	≤ 40	2.4	85	155	161	1	1	B25620B0757K701
900	80	18.2	6.0	1.0	≤ 40	2.3	116	95	101	1.13	3	B25620B0907K703
950	70	17.6	5.9	1.5	≤ 60	2.1	85	173	179	1.1	1	B25620B0957K701
1240	80	18.2	6.1	1.3	≤ 40	2.2	116	120	126	1.4	3	B25620B0128K743
1300	70	17.7	5.9	1.5	≤ 60	1.9	85	223	229	1.4	1	B25620B0138K701
1400	80	18.1	6.0	1.5	≤ 40	2.1	116	132	138	1.55	3	B25620B0148K703
1500	80	33.8	11.3	0.9	≤ 40	2.1	116	155	161	1.75	3	B25620B0158K703
1900	80	34.7	11.6	1.0	≤ 60	2	116	173	179	1.95	3	B25620B0198K703
2600	80	35.5	11.9	1.1	≤ 60	1.8	116	223	229	2.56	3	B25620B0268K703
3000	80	35.8	11.9	1.2	≤ 90	1.8	116	248	254	2.85	3	B25620B0308K703
4000	100	40.0	13.3	1.1	≤ 100	1.4	116	345	351	4.14	3	B25620B0408K703
4000	100	40.0	13.3	1.1	≤ 100	1.4	116	345	351	4.18	4	B25620C0408K703

<sup>1</sup> Please refer to current derating section for more details

<sup>2</sup> ESR at 1 kHz (typical value)

Other configurations and capacitance tolerances upon request



$V_{RDC} = 900 \text{ V DC} / V_{TT} = 1350 \text{ V DC, } 10\text{s} / V_{TC} = 4000 \text{ V AC, } 10\text{s}$ 

$C_R$ $\mu\text{F}$	$I_{MAX}^1$ A	$I_s$ kA	$\hat{I}$ kA	ESR <sup>2</sup> m $\Omega$	$L_{self}$ nH	$R_{TH}$ K/W	D mm	$H_c$ mm	$H_T$ mm	Weight kg	Fig.	Ordering code
220	50	8.1	2.7	1.5	≤ 40	4	85	70	76	0.45	1	B25620B0227K881
220	50	8.1	2.7	1.5	≤ 40	4	85	74	76	0.48	2	B25620C0227K881
350	50	8.0	2.7	1.7	≤ 40	3.3	85	95	101	0.58	1	B25620B0357K881
350	50	8.0	2.7	1.7	≤ 40	3.3	85	99	101	0.61	2	B25620C0357K881
440	65	16.3	5.4	1.1	≤ 40	2.9	116	70	76	0.88	3	B25620B0447K883
480	55	8.1	2.7	2.1	≤ 40	2.9	85	120	126	0.71	1	B25620B0487K881
480	55	8.1	2.7	2.1	≤ 40	2.9	85	124	126	0.74	2	B25620C0487K881
550	50	8.3	2.8	2.3	≤ 40	2.8	85	132	138	0.87	1	B25620B0557K881
550	50	8.3	2.8	2.3	≤ 40	2.8	85	136	138	0.9	2	B25620C0557K881
600	70	15.5	5.1	1.5	≤ 40	2.4	85	155	161	1	1	B25620B0607K881
700	70	16.1	5.3	1.2	≤ 40	2.3	116	95	101	1.13	3	B25620B0707K883
750	75	17.3	5.8	1.6	≤ 60	2.1	85	173	179	1.1	1	B25620B0757K881
750	75	17.3	5.8	1.6	≤ 60	2.1	85	177	179	1.13	2	B25620C0757K881
900	75	14.0	4.7	1.6	≤ 60	1.9	85	223	229	1.4	1	B25620B0907K881
970	75	16.3	5.4	1.4	≤ 40	2.2	116	120	126	1.4	3	B25620B0977K883
1000	80	13.7	4.6	1.7	≤ 90	1.9	85	248	254	1.6	1	B25620B0108K881
1100	80	16.3	5.4	1.5	≤ 40	2.1	116	132	138	1.55	3	B25620B0118K883
1200	80	31.0	10.3	1.0	≤ 40	2.1	116	155	161	1.75	3	B25620B0128K883
1500	80	33.1	11.0	1.1	≤ 60	2	116	173	179	1.95	3	B25620B0158K883
1500	80	33.1	11.0	1.1	≤ 60	2	116	177	179	1.99	4	B25620C0158K883
2000	80	33.3	11.0	1.2	≤ 60	1.8	116	223	229	2.56	3	B25620B0208K883
2300	80	33.3	11.0	1.3	≤ 90	1.8	116	248	254	2.85	3	B25620B0238K883
3000	100	38.5	12.8	1.2	≤ 100	1.4	116	345	351	4.14	3	B25620B0308K883

<sup>1</sup> Please refer to current derating section for more details

<sup>2</sup> ESR at 1 kHz (typical value)

Other configurations and capacitance tolerances upon request

$V_{RDC} = 1100 \text{ V DC} / V_{TT} = 1650 \text{ V DC, } 10\text{s} / V_{TC} = 4000 \text{ V AC, } 10\text{s}$ 

$C_R$ $\mu\text{F}$	$I_{MAX}^1$ A	$I_s$ kA	$\hat{I}$ kA	ESR <sup>2</sup> m $\Omega$	$L_{self}$ nH	$R_{TH}$ K/W	D mm	H <sub>c</sub> mm	H <sub>r</sub> mm	Weight kg	Fig.	Ordering code
140	50	7.7	2.6	1.8	≤ 40	4	85	70	76	0.45	1	B25620B1147K101
140	50	7.7	2.6	1.8	≤ 40	4	85	74	76	0.48	2	B25620C1147K101
230	50	7.2	2.3	1.9	≤ 40	3.3	85	95	101	0.58	1	B25620B1237K101
280	75	15.5	5.1	1.2	≤ 40	2.9	116	70	76	0.88	3	B25620B1287K103
310	50	7.7	2.6	2.3	≤ 40	2.9	85	120	126	0.71	1	B25620B1317K101
310	50	7.7	2.6	2.3	≤ 40	2.9	85	124	126	0.74	2	B25620C1317K101
420	63	8.8	2.9	2.4	≤ 40	2.8	85	135	141	0.87	1	B25620B1427A101*
420	63	8.8	2.9	2.4	≤ 40	2.8	85	139	141	0.9	2	B25620C1427A101*
420	75	17.3	5.8	1.7	≤ 40	2.4	85	155	161	1	1	B25620B1427K101
420	75	17.3	5.8	1.7	≤ 40	2.4	85	159	161	1.03	2	B25620C1427K101
450	75	14.9	4.9	1.3	≤ 40	2.3	116	95	101	1.13	3	B25620B1457K103
480	80	15.6	5.2	1.8	≤ 60	2.1	85	173	179	1.1	1	B25620B1487K101
480	80	15.6	5.2	1.8	≤ 60	2.1	85	177	179	1.13	2	B25620C1487K101
610	80	15.1	5.0	1.7	≤ 40	2.2	116	120	126	1.4	3	B25620B1617K103
650	80	13.4	4.4	1.8	≤ 90	1.9	85	248	254	1.6	1	B25620B1657K101
700	80	15.1	5.0	1.7	≤ 40	2.1	116	132	138	1.55	3	B25620B1707K103
940	100	29.4	9.9	1.2	≤ 60	2	116	173	179	1.95	3	B25620B1947K103
1100	100	27.7	9.3	1.3	≤ 100	1.8	116	223	229	2.56	3	B25620B1118K103
1400	100	28.9	9.6	1.3	≤ 90	1.8	116	248	254	2.85	3	B25620B1148K103
1500	100	29.3	9.7	1.5	≤ 90	1.7	116	273	279	3.13	3	B25620B1158K103
1900	100	34.4	11.5	1.2	≤ 100	1.4	116	345	351	4.14	3	B25620B1198K103

\* Capacitance tolerance A: -15% to 0%

<sup>1</sup> Please refer to current derating section for more details

<sup>2</sup> ESR at 1 kHz (typical value)

Other configurations and capacitance tolerances upon request

$V_{RDC} = 1200 \text{ V DC} / V_{TT} = 1800 \text{ V DC, } 10\text{s} / V_{TC} = 4000 \text{ V AC, } 10\text{s}$ 

$C_R$ $\mu\text{F}$	$I_{MAX}^1$ A	$I_s$ kA	$\hat{I}$ kA	ESR <sup>2</sup> m $\Omega$	$L_{self}$ nH	$R_{TH}$ K/W	D mm	$H_c$ mm	$H_T$ mm	Weight kg	Fig.	Ordering code
120	50	7.1	2.4	1.9	$\leq 40$	4	85	70	76	0.45	1	B25620B1127K201
180	50	7.1	2.4	2.1	$\leq 40$	3.3	85	95	101	0.58	1	B25620B1187K201
250	50	7.1	2.4	2.4	$\leq 40$	2.9	85	120	126	0.71	1	B25620B1257K201
280	50	7.1	2.4	2.5	$\leq 40$	2.8	85	132	138	0.87	1	B25620B1287K201
300	65	14.0	4.7	1.8	$\leq 40$	2.4	85	155	161	1	1	B25620B1307K201
350	65	13.6	4.5	1.9	$\leq 60$	2.1	85	173	179	1.1	1	B25620B1357K201
360	70	15.2	5.1	1.6	$\leq 40$	2.3	116	95	101	1.13	3	B25620B1367K203
500	75	15.3	5.1	1.7	$\leq 40$	2.2	116	120	126	1.4	3	B25620B1507K203
520	70	14.9	4.9	1.6	$\leq 60$	1.9	85	223	229	1.4	1	B25620B1527K201
570	75	15.4	5.1	1.7	$\leq 40$	2.1	116	132	138	1.55	3	B25620B1577K203
600	70	15.1	5.0	1.7	$\leq 90$	1.9	85	248	254	1.6	1	B25620B1607K201
620	80	29.3	9.7	1.3	$\leq 60$	2.1	116	155	161	1.75	3	B25620B1627K203
730	100	30.8	10.2	1.3	$\leq 60$	2	116	173	179	1.95	3	B25620B1737K203
1000	100	30.7	10.2	1.4	$\leq 90$	1.8	116	223	229	2.56	3	B25620B1108K203
1200	100	29.7	9.9	1.4	$\leq 90$	1.8	116	248	254	2.85	3	B25620B1128K203
1600	100	36.7	12.3	1.3	$\leq 100$	1.4	116	345	351	4.14	3	B25620B1168K203

<sup>1</sup> Please refer to current derating section for more details

<sup>2</sup> ESR at 1 kHz (typical value)

Other configurations and capacitance tolerances upon request

$V_{RDC} = 1320 \text{ V DC} / V_{TT} = 1980 \text{ V DC, 10s} / V_{TC} = 4000 \text{ V AC, 10s}$ 

$C_R$ $\mu\text{F}$	$I_{MAX}^1$ A	$I_s$ kA	$\hat{I}$ kA	ESR <sup>2</sup> m $\Omega$	$L_{self}$ nH	$R_{TH}$ K/W	D mm	$H_c$ mm	$H_T$ mm	Weight kg	Fig.	Ordering code
100	45	6.6	2.2	2.2	≤ 40	4	85	70	76	0.45	1	B25620B1107K321
160	48	6.8	2.3	2.3	≤ 40	3.3	85	95	101	0.58	1	B25620B1167K321
220	45	7.4	2.5	2.6	≤ 40	2.9	85	120	126	0.71	1	B25620B1227K321
220	45	7.4	2.5	2.6	≤ 40	2.9	85	124	126	0.74	2	B25620C1227K321
260	45	7.6	2.6	2.7	≤ 40	2.8	85	132	138	0.87	1	B25620B1267K321
260	45	7.6	2.6	2.7	≤ 40	2.8	85	136	138	0.9	2	B25620C1267K321
310	65	14.3	4.8	1.7	≤ 40	2.3	116	95	101	1.13	3	B25620B1317K323
340	70	14.8	5.0	2.1	≤ 60	2.1	85	173	179	1.1	1	B25620B1347K321
340	70	14.8	5.0	2.1	≤ 60	2.1	85	177	179	1.13	2	B25620C1347K321
400	70	12.4	4.1	2.2	≤ 90	1.9	85	223	229	1.4	1	B25620B1407K321
420	65	14.1	4.7	1.8	≤ 40	2.2	116	120	126	1.4	3	B25620B1427K323
480	70	14.1	4.7	1.8	≤ 40	2.1	116	132	138	1.55	3	B25620B1487K323
500	70	13.8	4.6	2.3	≤ 90	1.9	85	248	254	1.6	1	B25620B1507K321
520	80	26.9	8.9	1.4	≤ 40	2.1	116	155	161	1.75	3	B25620B1527K323
660	100	27.8	9.3	1.4	≤ 90	2	116	173	179	1.95	3	B25620B1667K323
880	100	27.4	9.1	1.6	≤ 90	1.8	116	223	229	2.56	3	B25620B1887K323
940	100	26.9	8.9	1.6	≤ 90	1.8	116	248	254	2.85	3	B25620B1947K323
1000	100	26.4	8.8	1.6	≤ 90	1.7	116	273	279	3.13	3	B25620B1108K323
1300	100	36.3	12.1	1.4	≤ 100	1.4	116	345	351	4.14	3	B25620B1138K323

<sup>1</sup> Please refer to current derating section for more details

<sup>2</sup> ESR at 1 kHz (typical value)

Other configurations and capacitance tolerances upon request

$V_{RDC} = 1500 \text{ V DC} / V_{TT} = 2250 \text{ V DC, 10s} / V_{TC} = 4000 \text{ V AC, 10s}$ 

$C_R$ $\mu\text{F}$	$I_{MAX}^1$ A	$I_s$ kA	$\hat{I}$ kA	ESR <sup>2</sup> m $\Omega$	$L_{self}$ nH	$R_{TH}$ K/W	D mm	$H_c$ mm	$H_T$ mm	Weight kg	Fig.	Ordering Code
90	40	6.4	2.1	2.4	$\leq 40$	4	85	70	76	0.45	1	B25620B1906K501
140	40	6.4	2.1	2.6	$\leq 40$	3.3	85	95	101	0.58	1	B25620B1147K501
190	40	6.4	2.1	2.8	$\leq 40$	2.9	85	120	126	0.71	1	B25620B1197K501
220	40	6.6	2.2	2.7	$\leq 40$	2.8	85	132	138	0.87	1	B25620B1227K501
230	50	12.9	4.3	2.3	$\leq 40$	2.4	85	155	161	1	1	B25620B1237K501
270	50	12.4	4.1	1.8	$\leq 40$	2.3	116	95	101	1.13	3	B25620B1277K503
280	50	12.9	4.3	2.3	$\leq 60$	2.1	85	173	179	1.1	1	B25620B1287K501
370	50	12.5	4.2	2.3	$\leq 40$	2.2	116	120	126	1.4	3	B25620B1377K503
380	70	12.8	4.3	2.5	$\leq 60$	1.9	85	223	229	1.4	1	B25620B1387K501
420	50	12.5	4.2	2.3	$\leq 40$	2.1	116	132	139	1.55	3	B25620B1427K503
440	70	13.1	4.4	2.6	$\leq 90$	1.9	85	248	254	1.6	1	B25620B1447K501
450	60	25.2	8.4	1.7	$\leq 60$	2.1	116	155	161	1.75	3	B25620B1457K503
550	60	25.2	8.4	1.6	$\leq 60$	2	116	173	179	1.95	3	B25620B1557K503
740	80	25.0	8.3	1.8	$\leq 90$	1.8	116	223	229	2.56	3	B25620B1747K503
840	80	25.1	8.4	1.8	$\leq 90$	1.8	116	248	254	2.85	3	B25620B1847K503
1100	100	33.3	11.1	1.5	$\leq 100$	1.4	116	345	351	4.14	3	B25620B1118K503

<sup>1</sup> Please refer to current derating section for more details

<sup>2</sup> ESR at 1 kHz (typical value)

Other configurations and capacitance tolerances upon request

$V_{RDC} = 2000 \text{ V DC} / V_{TT} = 3000 \text{ V DC}, 10\text{s} / V_{TC} = 4000 \text{ V AC}, 10\text{s}$ 

$C_R$ $\mu\text{F}$	$I_{MAX}^1$ A	$I_s$ kA	$\hat{I}$ kA	ESR <sup>2</sup> m $\Omega$	$L_{self}$ nH	$R_{TH}$ K/W	D mm	H <sub>c</sub> mm	H <sub>T</sub> mm	Weight kg	Fig.	Ordering Code
40	35	4.5	1.5	3.3	≤ 60	4	85	70	76	0.45	1	B25620B1406K981
40	35	4.5	1.5	3.3	≤ 60	4	85	74	76	0.48	2	B25620C1406K981
70	40	4.9	1.6	3.5	≤ 60	3.3	85	95	101	0.58	1	B25620B1706K981
70	40	4.9	1.6	3.5	≤ 60	3.3	85	99	101	0.61	2	B25620C1706K981
100	40	4.9	1.6	3.6	≤ 60	2.9	85	120	126	0.71	1	B25620B1107K981
110	40	4.6	1.5	3.6	≤ 60	2.8	85	132	138	0.87	1	B25620B1117K981
145	50	10.0	3.4	2.7	≤ 60	2.1	85	173	179	1.1	1	B25620B1147K981
145	50	10.0	3.4	2.7	≤ 60	2.1	85	177	179	1.13	2	B25620C1147K981
190	60	9.6	3.2	2.8	≤ 60	2.2	116	120	126	1.4	3	B25620B1197K983
200	70	9.3	3.1	2.8	≤ 90	1.9	85	223	229	1.4	1	B25620B1207K981
215	60	9.6	3.2	2.9	≤ 40	2.1	116	132	138	1.55	3	B25620B1217K983
220	70	9.0	3.0	2.8	≤ 90	1.9	85	248	254	1.6	1	B25620B1227K981
230	80	17.8	5.9	1.8	≤ 40	2.1	116	155	161	1.75	3	B25620B1237K983
295	80	18.8	6.3	1.9	≤ 60	2	116	173	179	1.95	3	B25620B1297K983
380	80	17.8	5.9	2.2	≤ 90	1.8	116	223	229	2.56	3	B25620B1387K983
440	80	18.2	6.1	2.5	≤ 90	1.8	116	248	254	2.85	3	B25620B1447K983
460	100	18.2	6.0	2.8	≤ 90	1.7	116	263	269	3.0	3	B25620B1467K983
510	100	19.3	6.4	3	≤ 90	1.7	116	273	279	3.13	3	B25620B1517K983
600	100	25.1	8.4	2.2	≤ 100	1.4	116	345	351	4.14	3	B25620B1607K983

<sup>1</sup> Please refer to current derating section for more details

<sup>2</sup> ESR at 1 kHz (typical value)

Other configurations and capacitance tolerances upon request

### Display of ordering codes for EPCOS products

The ordering code for one and the same EPCOS product can be represented differently in data sheets, data books, other publications, on the EPCOS website, or in order-related documents such as shipping notes, order confirmations and product labels. The varying representations of the ordering codes are due to different processes employed and do not affect the specifications of the respective products. Detailed information can be found on the Internet under [www.epcos.com/orderingcodes](http://www.epcos.com/orderingcodes)

**2. Current derating**
**2.1 Current derating graphs for capacitors 700 V<sub>RDC</sub>**
**B25620B0287K701**

**B25620B0477K701**

**B25620B0567K703**

**B25620B0627K701**

**B25620B0707K701/ B25620C0707K701**

**B25620B0757K701**

**B25620B0907K703**

**B25620B0957K701**

**B25620B0128K743**



**B25620B0138K701**



**B25620B0148K703**



**B25620B0158K703**



**B25620B0198K703**



**B25620B0268K703**



**B25620B0308K703**



**B25620B0408K703/ B25620C0408K703**



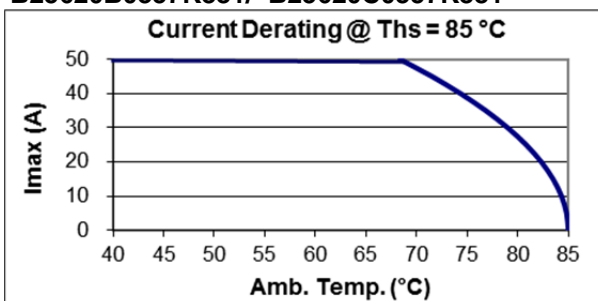

**2.2 Current derating graphs for capacitors 900 V<sub>RDC</sub>**
**B25620B0227K881/ B25620C0227K881**

**B25620B0357K881/ B25620C0357K881**

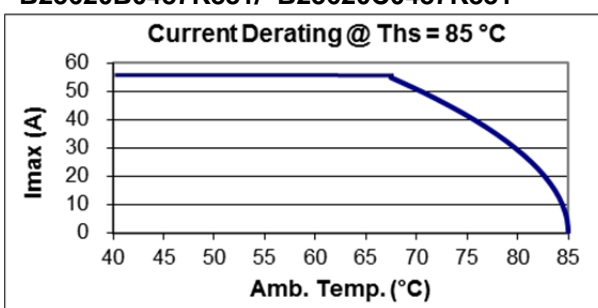
**B25620B0447K883**

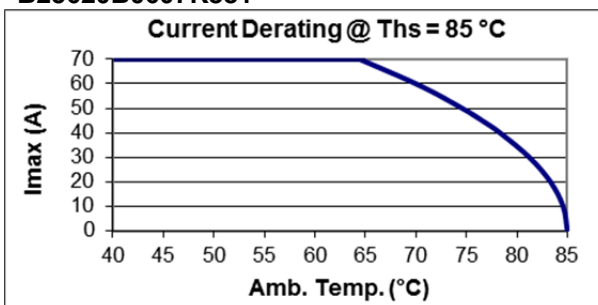
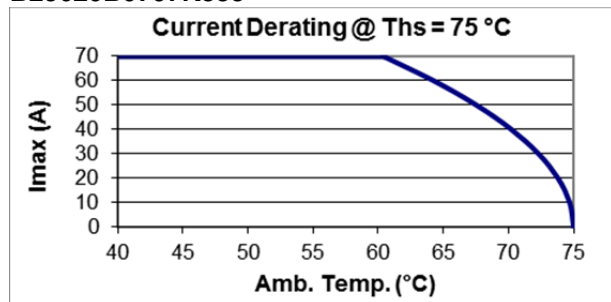
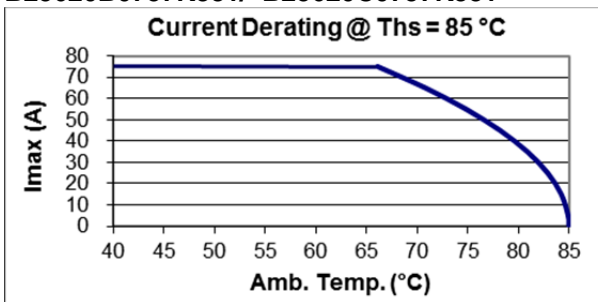
**B25620B0487K881/ B25620C0487K881**

**B25620B0557K881/ B25620C0557K881**

**B25620B0607K881**

**B25620B0707K883**

**B25620B0757K881/ B25620C0757K881**

**B25620B0907K881**



**B25620B0977K883**



**B25620B0108K881**

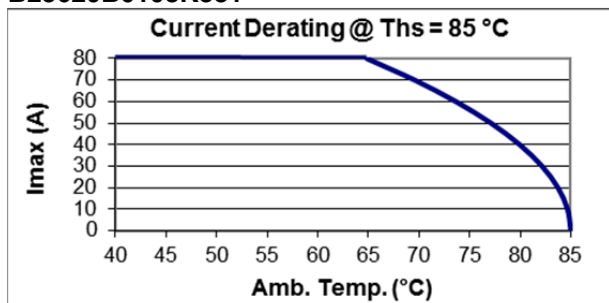

**B25620B0118K883**

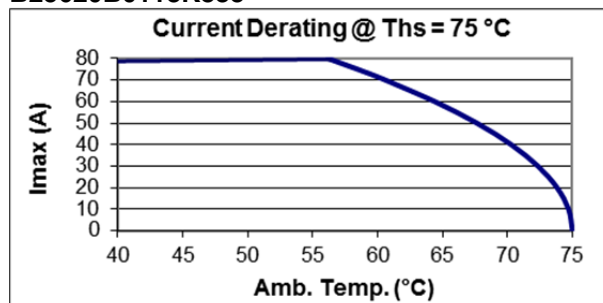

**B25620B0128K883**



**B25620B0158K883/ B25620C0158K883**

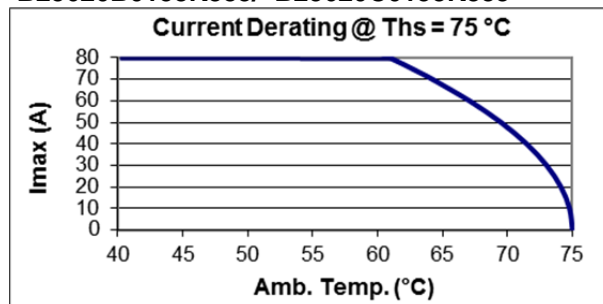

**B25620B0208K883**



**B25620B0238K883**

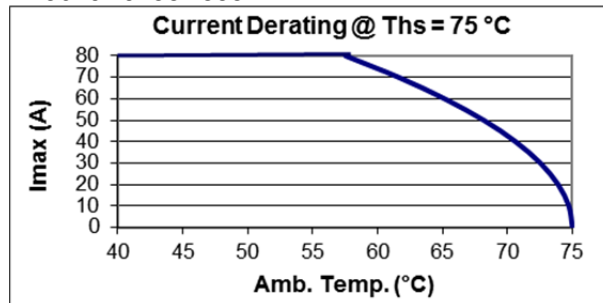

**B25620B0308K883**

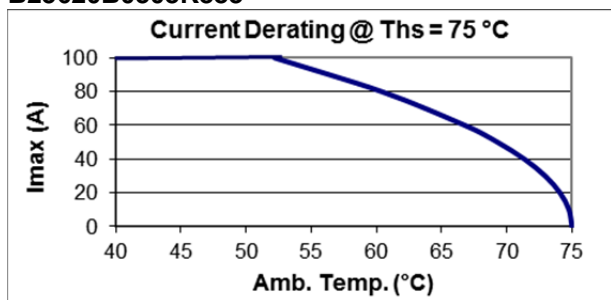

**2.3 Current derating graphs for capacitors 1100 V<sub>RDC</sub>**

**B25620B1147K101/ B25620C1147K101**

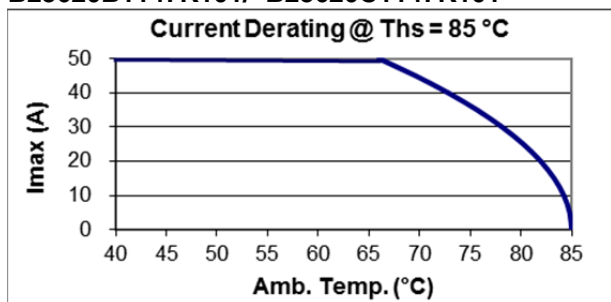

**B25620B1237K101**

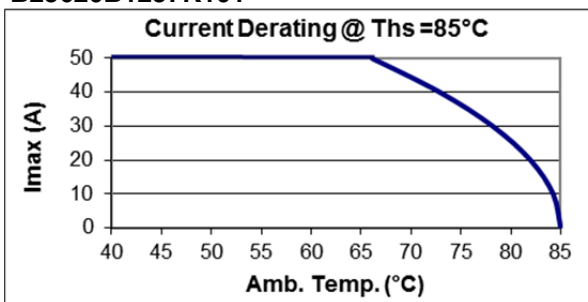

**B25620B1287K103**

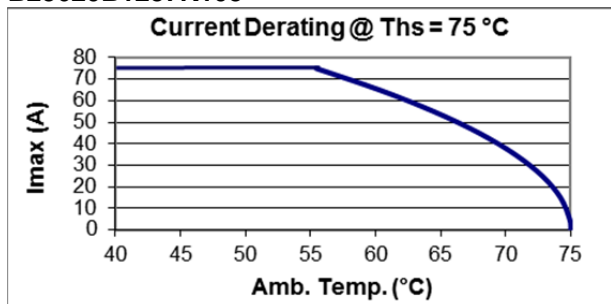

**B25620B1317K101/ B25620C1317K101**

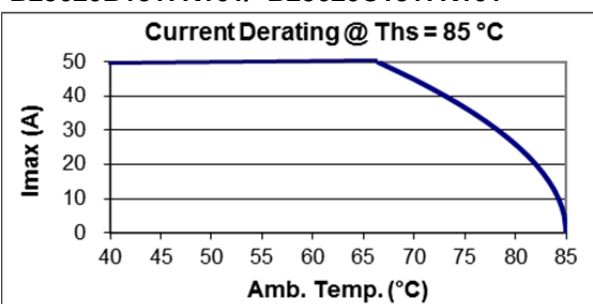

**B25620B1427A101/ B25620C1427A101**

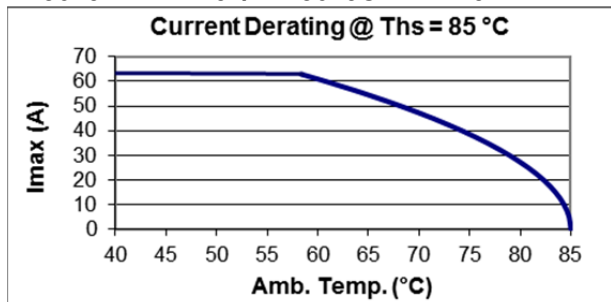

**B25620B1427K101/ B25620C1427K101**

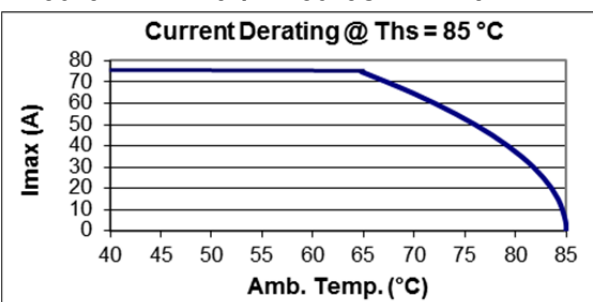

**B25620B1457K103**



**B25620B1487K101/ B25620C1487K101**

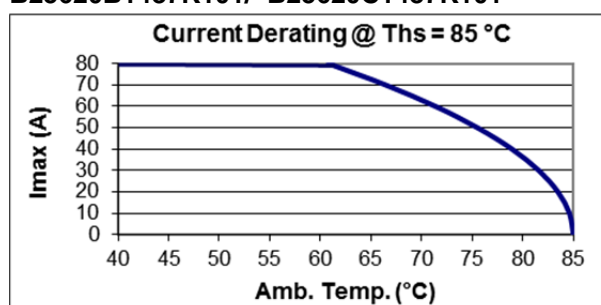

**B25620B1617K103**



**B25620B1657K101**

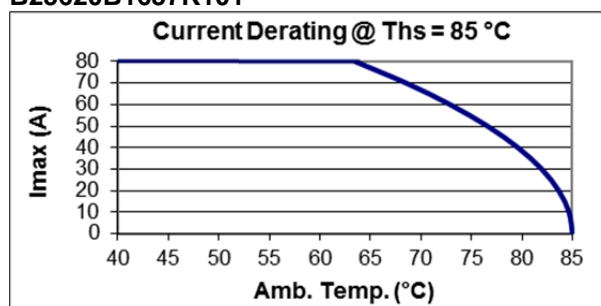

**B25620B1707K103**

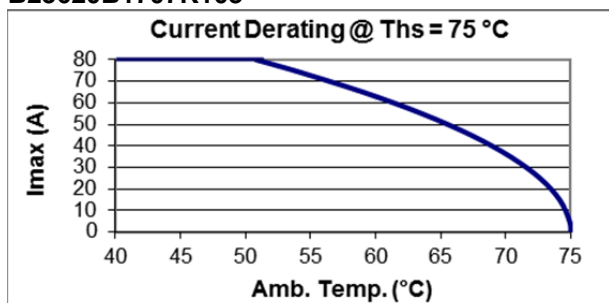

**B25620B1947K103**

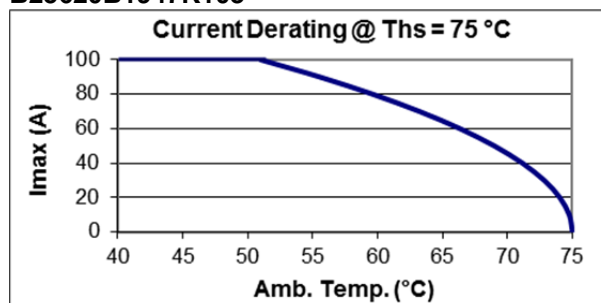

**B25620B1118K103**

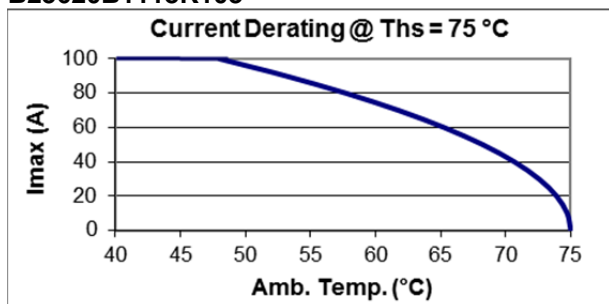

**B25620B1148K103**

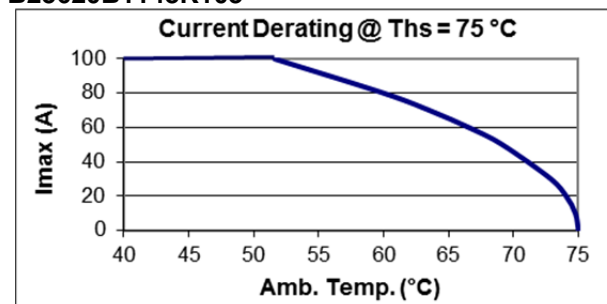

**B25620B1158K103**



**B25620B1198K103**



**2.4 Current derating graphs for capacitors 1200 V<sub>RDC</sub>**

**B25620B1127K201**



**B25620B1187K201**



**B25620B1257K201**

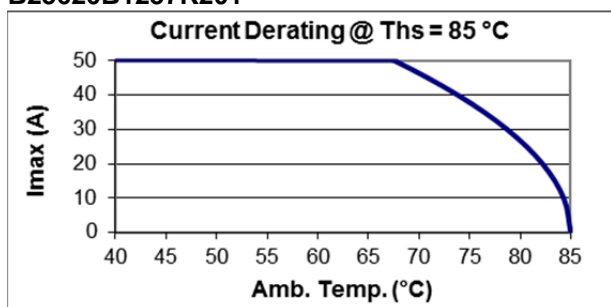

**B25620B1287K201**

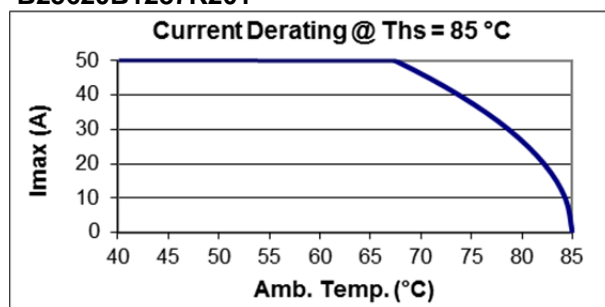

**B25620B1307K201**

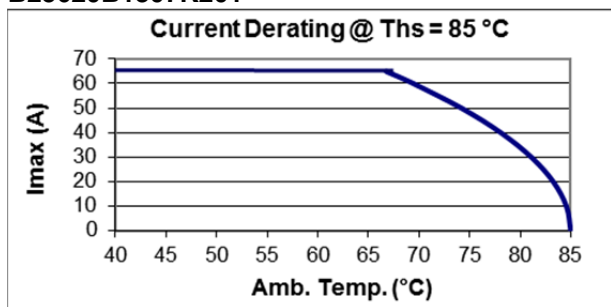

**B25620B1357K201**

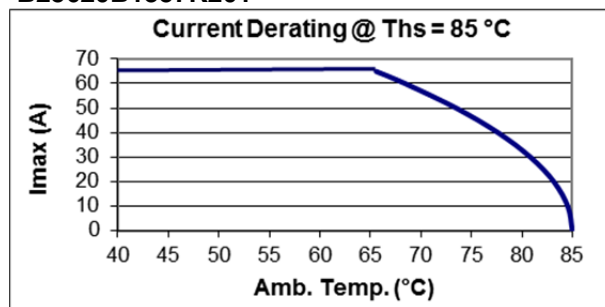

**B25620B1367K203**



**B25620B1507K203**



**B25620B1527K201**



**B25620B1577K203**



**B25620B1607K201**



**B25620B1627K203**



**B25620B1737K203**



**B25620B1108K203**



**B25620B1128K203**

**B25620B1168K203**

Current derating graphs are based on typical values. Graphs for capacitors rated 1320 / 1500/2000 U<sub>NDC</sub> are available upon request.

### 3. Service life



Service life  $t_{LD}$  at different hotspot temperature ( $\Theta_{hs}$ ) and voltage V

For capacitors with diameter 116 mm a maximum hot spot temperature of +85 °C is allowed during short term operation (maximum 10% of the total load duration) without further reduction of the service life.

The expected lifetime is a calculated value based on real application data and life endurance test for this capacitor series. The lifetime calculation correlates the time of test, voltage and temperature always comparing testing conditions to real application data and its own ageing factors. In order to determine the ageing factor used for this capacitor design it was performed life endurance tests with different stress is voltage and temperature. Failure criteria is capacitance drop higher than 3%.

4. FIT



The FIT (Failure In Time) of a component is defined as the number of expected failures in 10<sup>9</sup> hours of operation. The FIT rate is calculated on the basis of the number of components operating in the field and the estimated hours of operation. All the reports of failures are taken into consideration for this calculation, which is updated every year.

The other values in the graph are given as indication and calculated based on acceleration factors.



### Cautions and warnings

- In case of dents of more than 1 mm depth or any other mechanical damage, capacitors must not be used at all.
- Check tightness of the connections/terminals periodically.
- The energy stored in capacitors may be lethal. To prevent any chance of shock, discharge and short-circuit the capacitor before handling.
- Failure to follow cautions may result, worst case, in premature failures, bursting and fire.
- EPCOS AG is not responsible for any kind of possible damages to persons or things due to improper installation and application of capacitors for power electronics.

### Safety

- Electrical or mechanical misapplication of capacitors may be hazardous. Personal injury or property damage may result from bursting of the capacitor or from expulsion of oil or melted material due to mechanical disruption of the capacitor.
- Ensure good, effective grounding for capacitor enclosures.
- Observe appropriate safety precautions during operation (self-recharging phenomena and the high energy contained in capacitors).
- Handle capacitors carefully, because they may still be charged even after disconnection.
- The terminals of capacitors, connected bus bars and cables as well as other devices may also be energized.
- Follow good engineering practice.

### Thermal load

After installation of the capacitor it is necessary to verify that maximum hot-spot temperature is not exceeded at extreme service conditions.

### Mechanical protection

The capacitor has to be installed in a way that mechanical damages and dents in the aluminum can are avoided.

### Storage and operating conditions

Do not use or store capacitors in corrosive atmosphere, especially where chloride gas, sulfide gas, acid, alkali, salt or the like are present. In dusty environments regular maintenance and cleaning especially of the terminals is required to avoid conductive path between phases and/or phases and ground.

The maximum storage temperature is +85 °C.

### Service life expectancy

Electrical components do not have an unlimited service life expectancy; this applies to self-healing capacitors, too. The maximum service life expectancy may vary depending on the application the capacitor is used in.

## Important notes

The following applies to all products named in this publication:

1. Some parts of this publication contain **statements about the suitability of our products for certain areas of application**. These statements are based on our knowledge of typical requirements that are often placed on our products in the areas of application concerned. We nevertheless expressly point out **that such statements cannot be regarded as binding statements about the suitability of our products for a particular customer application**. As a rule, EPCOS is either unfamiliar with individual customer applications or less familiar with them than the customers themselves. For these reasons, it is always ultimately incumbent on the customer to check and decide whether an EPCOS product with the properties described in the product specification is suitable for use in a particular customer application.
2. We also point out that **in individual cases, a malfunction of electronic components or failure before the end of their usual service life cannot be completely ruled out in the current state of the art, even if they are operated as specified**. In customer applications requiring a very high level of operational safety and especially in customer applications in which the malfunction or failure of an electronic component could endanger human life or health (e.g. in accident prevention or life-saving systems), it must therefore be ensured by means of suitable design of the customer application or other action taken by the customer (e.g. installation of protective circuitry or redundancy) that no injury or damage is sustained by third parties in the event of malfunction or failure of an electronic component.
3. **The warnings, cautions and product-specific notes must be observed.**
4. In order to satisfy certain technical requirements, **some of the products described in this publication may contain substances subject to restrictions in certain jurisdictions (e.g. because they are classed as hazardous)**. Useful information on this will be found in our Material Data Sheets on the Internet ([www.epcos.com/material](http://www.epcos.com/material)). Should you have any more detailed questions, please contact our sales offices.
5. We constantly strive to improve our products. Consequently, **the products described in this publication may change from time to time**. The same is true of the corresponding product specifications. Please check therefore to what extent product descriptions and specifications contained in this publication are still applicable before or when you place an order. We also **reserve the right to discontinue production and delivery of products**. Consequently, we cannot guarantee that all products named in this publication will always be available. The aforementioned does not apply in the case of individual agreements deviating from the foregoing for customer-specific products.
6. Unless otherwise agreed in individual contracts, **all orders are subject to the current version of the "General Terms of Delivery for Products and Services in the Electrical Industry" published by the German Electrical and Electronics Industry Association (ZVEI)**.
7. **Our manufacturing sites serving the automotive business apply the IATF 16949 standard**. The IATF certifications confirm our compliance with requirements regarding the quality management system in the automotive industry. Referring to customer requirements and customer specific requirements ("CSR") TDK always has and will continue to have the policy of respecting individual agreements. Even if IATF 16949 may appear to support the acceptance of unilateral requirements, we hereby like to emphasize that **only requirements mutually agreed upon can and will be implemented in our Quality Management System**. For clarification purposes we like to point out that obligations from IATF 16949 shall only become legally binding if individually agreed upon.

## Important notes

8. The trade names EPCOS, CeraCharge, CeraDiode, CeraLink, CeraPad, CeraPlas, CSMP, CTVS, DeltaCap, DigiSiMic, ExoCore, FilterCap, FormFit, LeaXield, MiniBlue, MiniCell, MKD, MKK, MotorCap, PCC, PhaseCap, PhaseCube, PhaseMod, PhiCap, PowerHap, PQSine, PQvar, SIFERRIT, SIFI, SIKOREL, SilverCap, SIMDAD, SiMic, SIMID, SineFormer, SIOV, ThermoFuse, WindCap are **trademarks registered or pending** in Europe and in other countries. Further information will be found on the Internet at [www.epcos.com/trademarks](http://www.epcos.com/trademarks).

Release 2018-06

# Mouser Electronics

Authorized Distributor

Click to View Pricing, Inventory, Delivery & Lifecycle Information:

## [EPCOS / TDK:](#)

[B25620B1118K103](#) [B25620B1147K101](#) [B25620B1167K321](#) [B25620B1227K321](#) [B25620B1237K101](#)  
[B25620B1347K321](#) [B25620B1406K981](#) [B25620B1487K101](#) [B25620B1706K981](#) [B25620B1117K981](#)  
[B25620B1427A101](#) [B25620B1147K981](#) [B25620B1267K321](#) [B25620B1317K101](#) [B25620C1427A101](#)  
[B25620B0227K881](#) [B25620B0487K881](#) [B25620B0557K881](#) [B25620B0357K881](#) [B25620B0757K881](#)  
[B25620B1108K203](#) [B25620B1667K323](#) [B25620B1487K323](#) [B25620C1347K321](#) [B25620B0977K883](#)  
[B25620B1427K323](#) [B25620B1457K103](#) [B25620B1577K203](#) [B25620B0707K883](#) [B25620B1707K103](#)  
[B25620B1947K103](#) [B25620B1297K983](#) [B25620B0118K883](#) [B25620B1317K323](#) [B25620B0128K743](#)  
[B25620B0158K883](#) [B25620B0627K701](#) [B25620B1158K103](#) [B25620B0287K701](#) [B25620C0757K881](#)  
[B25620B0707K701](#) [B25620C1406K981](#) [B25620B1737K203](#) [B25620B1517K983](#) [B25620B0447K883](#)  
[B25620C1487K101](#) [B25620B1108K323](#) [B25620C1267K321](#) [B25620B0148K703](#) [B25620B1197K983](#)  
[B25620B0567K703](#) [B25620C1427K101](#) [B25620B1217K983](#) [B25620B1427K101](#) [B25620B1617K103](#)  
[B25620C0158K883](#) [B25620C1706K981](#) [B25620B1467K983](#) [B25620B1367K203](#)



Компания «ЭлектроПласт» предлагает заключение долгосрочных отношений при поставках импортных электронных компонентов на взаимовыгодных условиях!

Наши преимущества:

- Оперативные поставки широкого спектра электронных компонентов отечественного и импортного производства напрямую от производителей и с крупнейших мировых складов;
- Поставка более 17-ти миллионов наименований электронных компонентов;
- Поставка сложных, дефицитных, либо снятых с производства позиций;
- Оперативные сроки поставки под заказ (от 5 рабочих дней);
- Экспресс доставка в любую точку России;
- Техническая поддержка проекта, помощь в подборе аналогов, поставка прототипов;
- Система менеджмента качества сертифицирована по Международному стандарту ISO 9001;
- Лицензия ФСБ на осуществление работ с использованием сведений, составляющих государственную тайну;
- Поставка специализированных компонентов (Xilinx, Altera, Analog Devices, Intersil, Interpoint, Microsemi, Aeroflex, Peregrine, Syfer, Eurofarad, Texas Instrument, Miteq, Cobham, E2V, MA-COM, Hittite, Mini-Circuits, General Dynamics и др.);

Помимо этого, одним из направлений компании «ЭлектроПласт» является направление «Источники питания». Мы предлагаем Вам помощь Конструкторского отдела:

- Подбор оптимального решения, техническое обоснование при выборе компонента;
- Подбор аналогов;
- Консультации по применению компонента;
- Поставка образцов и прототипов;
- Техническая поддержка проекта;
- Защита от снятия компонента с производства.



#### Как с нами связаться

**Телефон:** 8 (812) 309 58 32 (многоканальный)

**Факс:** 8 (812) 320-02-42

**Электронная почта:** [org@eplast1.ru](mailto:org@eplast1.ru)

**Адрес:** 198099, г. Санкт-Петербург, ул. Калинина, дом 2, корпус 4, литера А.