

# MAX17681 Evaluation Kit

# Evaluates: MAX17681 for Isolated +24V Output Configuration

## General Description

The MAX17681EVKITF is a fully assembled and tested circuit board that demonstrates the performance of the MAX17681 high-efficiency, iso-buck DC-DC Converter. The EV kit operates over a wide input-voltage range of 17V to 36V and uses primary-side feedback to regulate the output voltage. The EV kit output is programmed to +24V at 100mA, with  $\pm 8\%$  output voltage regulation.

The EV kit comes installed with the MAX17681 in a 10-pin (3mm x 2mm) TDFN package.

## Features

- 17V to 36V Input Voltage Range
- +24V, 100mA Continuous Current
- EN/UVLO Input
- 200kHz Switching Frequency
- Overcurrent Protection
- No Optocoupler
- Delivers up to 2.4W Output Power
- Overtemperature Protection
- Proven PCB Layout

Ordering Information appears at end of data sheet.

## Quick Start

### Recommended Equipment

- One 15V–60V DC, 0.5A power supply
- One resistive load 100mA sink capacity
- Two digital multimeters (DMM)

**Caution: Do not turn on the power supply until all connections are completed.**

### Test Procedure

The EV kit comes with the default output configuration programmed to +24V.

- 1) Verify that J1 is open.
- 2) Verify that R7 is not installed.
- 3) Set the power supply output to 24V. Disable the power supply.
- 4) Connect the positive terminal of the power supply to the  $V_{IN}$  PCB pad and the negative terminal to the nearest PGND PCB pad. Connect a 100mA resistive load across the +24V PCB pad and the GND0 PCB pad.
- 5) Connect a DMM configured in voltmeter mode across the +24V PCB pad and the nearest GND0 PCB pad.
- 6) Enable the input power supply.
- 7) Verify that output voltage is at +24V (with allowable tolerance of  $\pm 8\%$ ) with respect to GND0.
- 8) If required, vary the input voltage from 17V to 36V, and the load current from 0mA to 100mA and verify that output voltage is at +24V (with allowable tolerance of  $\pm 8\%$ ).

**Detailed Description**

The MAX17681EVKITF evaluation kit (EV kit) is a fully assembled and tested circuit board that demonstrates the performance of the MAX17681 high efficiency, iso-buck DC-DC converter designed to provide an isolated power up to 2.4W. The EV kit generates +24V, 100mA from a 17V to 36V input supply. The EV kit features a forced PWM control scheme that provides constant switching-frequency of 200kHz operation at all load and line conditions.

The EV kit includes an EN/UVLO PCB pad to monitor and program the EN/UVLO pin of the MAX17681. The  $V_{PRI}$  PCB pad helps measure the regulated primary output voltage ( $V_{PRI}$ ). An additional  $\overline{RESET}$  PCB pad is available for monitoring the health of primary output voltage ( $V_{PRI}$ ).  $\overline{RESET}$  is pulled low if FB voltage drops below 92.5% of its set value.  $\overline{RESET}$  goes high impedance 1024 clock cycles after FB voltage rises above 95.5% of its set value. The programmable soft-start feature allows users to reduce the input inrush current.

The iso-buck is a synchronous-buck-converter-based topology, useful for generating isolated outputs at low power level without using an optocoupler. The detailed procedure for setting the soft-start time, ENABLE/UVLO divider, primary output voltage ( $V_{PRI}$ ) selection, adjusting

the primary output voltage, primary inductance selection, turns-ratio selection, output capacitor selection, output diode selection and external loop compensation are given in MAX17681 IC data sheet.

**Enable Control (J1)**

The EN/UVLO pin on the device serves as an on/off control while also allowing the user to program the input undervoltage-lockout (UVLO) threshold. J1 configures the EV kit’s output for turn-on/turn-off control. Install a shunt across J1 pins 2-3 to disable  $V_{OUT}$ . See [Table 1](#) for proper J1 configurations.

**NOTE 1:** The secondary output diodes D1 is rated to carry short-circuit current only for few 100’s of ms and is not rated to carry the continuous short-circuit current.

**NOTE 2:** The iso-buck converter typically needs 10% minimum load to regulate the output voltage. In this design when the +24V rail is healthy, the U2 sinks the minimum load current required to regulate the output voltages within ±8% regulation.

**Table 1. Enable Control (EN/UVLO) (J1) Jumper Settings**

SHUNT POSITION	EN/UVLO PIN	$V_{OUT}$
J1		
1-2	Connected to $V_{IN}$	Always Enabled
2-3	Connected to GND	Always Disabled
Open*	Connected to midpoint of R1, R2 resistor-divider	Enabled at $V_{IN} \geq 15.5V$

\*Default position.

EV Kit Performance Report

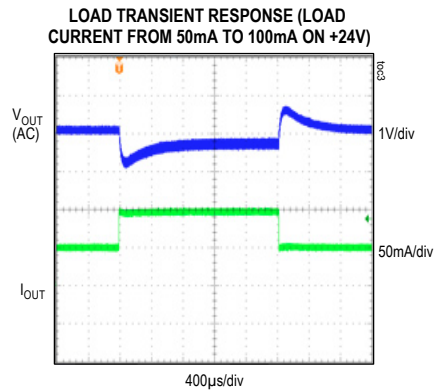
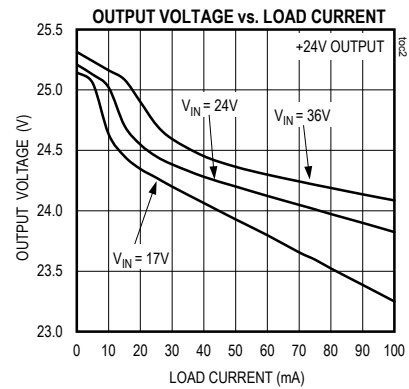
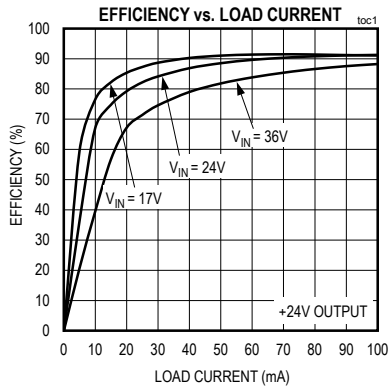

## MAX17681 Evaluation Kit

Evaluates: MAX17681 for Isolated  
+24V Output Configuration

### Component Suppliers

SUPPLIER	WEBSITE
Würth Elektronik	www.we-online.com
Murata Americas	www.murata.com
Panasonic Corp.	www.panasonic.com

**Note:** Indicate that you are using the MAX17681 when contacting these component suppliers.

### Component Information, PCB Layout, and Schematic

See the following links for component information, PCB layout diagrams, and schematic.

- [MAX17681F EV BOM](#)
- [MAX17681F EV PCB Layout](#)
- [MAX17681F EV Schematic](#)

### Ordering Information

PART	TYPE
MAX17681EVKITF#	EVKIT

#Denotes RoHS compliant.

## Revision History

REVISION NUMBER	REVISION DATE	DESCRIPTION	PAGES CHANGED
0	3/16	Initial release	—
1	4/16	Updated <i>General Description</i> section and <i>Bill of Materials</i>	1–2

For pricing, delivery, and ordering information, please contact Maxim Direct at 1-888-629-4642, or visit Maxim Integrated's website at [www.maximintegrated.com](http://www.maximintegrated.com).

*Maxim Integrated cannot assume responsibility for use of any circuitry other than circuitry entirely embodied in a Maxim Integrated product. No circuit patent licenses are implied. Maxim Integrated reserves the right to change the circuitry and specifications without notice at any time.*

S NO	Designation	Qty	Description	Manufacturer Partnumber-1	Manufacturer Partnumber-2	Manufacturer Partnumber-3	Manufacturer Partnumber-4
1	C1	1	1 $\mu$ F $\pm$ 10%, 50V, X7R Ceramic capacitor (1206)	Murata GRM31CR71H105KA61	KEMET C1206C105K5RAC	Murata GRM31MR71H105KA88	
2	C2	1	1 $\mu$ F $\pm$ 10% 16V X7R Ceramic capacitor (0603)	Murata GRM188R71C105KA12	KEMET C0603C105K4RAC	TDK C1608X7R1C105K	TAIYO YUDEN EMK107B7105KA
3	C3	1	0.033UFnF $\pm$ 10%, 25V, X7R ceramic capacitor (0402)	Murata GRM155R71E333KA88			
4	C4	1	0.082UFnF $\pm$ 10%, 16V, X7R ceramic capacitor (0402)	Murata GRM155R71C823K	KEMET C0402C823K4RAC		
5	C5	1	820pF $\pm$ 5%, 50V, X7R ceramic capacitor (0402)	Murata GRM155R71H821K	KEMET C0402C821K5RAC		
6	C6	1	10uF $\pm$ 10%, 16V, X7R ceramic capacitor (1206)	Murata GRM31CR71C106KAC7			
7	C7	1	0.01uF $\pm$ 10%, 50V, X7R ceramic capacitor (0402)	Murata GRM155R71H103KA88	KEMET C0402C103K5RAC		
8	C8	1	22uF, 20%, 50V, ALUMINUM ELECTROLYTIC CAPACITOR 6.60*6.60mm,	Panasonic EEEFK1H220P			
9	C9	1	2.2uF $\pm$ 10%, 50V, X7R ceramic capacitor (1206)	Murata GRM31CR71H225KA88	TAIYO YUDEN UMK316B7225K		
10	C10	1	1000pF $\pm$ 10%, 1500V, X7R ceramic capacitor (1206)	AVX 1206SC102KAT			
11	D1	1	100V/1A, PowerDI <sup>®</sup> 123	Diode Inc. DFLS1100-7			
12	J1	1	3-pin headers	SULLINS ELECTRONICS CORP PEC03SAAN			
13	R1	1	3.01M Ohm $\pm$ 1% resistor (0402)	VISHAY DALE CRCW04023M01FK			
14	R2	1	261K Ohm $\pm$ 1% resistor (0402)	VISHAY DALE CRCW0402261KFK			
15	R3	1	110K Ohm $\pm$ 1% resistor (0402)	VISHAY DALE CRCW0402110KFK			
16	R4	1	10.5k $\Omega$ $\pm$ 1% resistor (0402)	PANASONIC ERJ-2RKF1052			
17	R5	1	3.74k $\Omega$ $\pm$ 1% resistor (0402)	PANASONIC ERJ2RKF3741			
18	R6	1	100k $\Omega$ $\pm$ 5% resistor (0402)	PANASONIC ERJ-2GEJ104X			
19	R7	1	OPEN (0402)				

20	R8	1	22Ω ±1% resistor (0402)	VISHAY DALE CRCW040222R0FK			
21	R9	1	90.9kΩ ±1% resistor (0402)	PANASONIC ERJ- 2RKF9092X			
22	R10	1	10kΩ ±1% resistor (0402)	VISHAY DALE CRCW040210K0JN			
23	T1	1	EP10, 8-pin SMT, 80μH, 1.2A, (5-8):(4-1)=2.4:1	WURTH ELECTRONICS INC. 750342860			
24	U1	1	MAX17681 TDFN10 3*2mm Iso buck DC-DC converter	MAX17681ATB+			
25	U2	1	Shunt regulator SOT25	Diode Inc. TL431BW5			

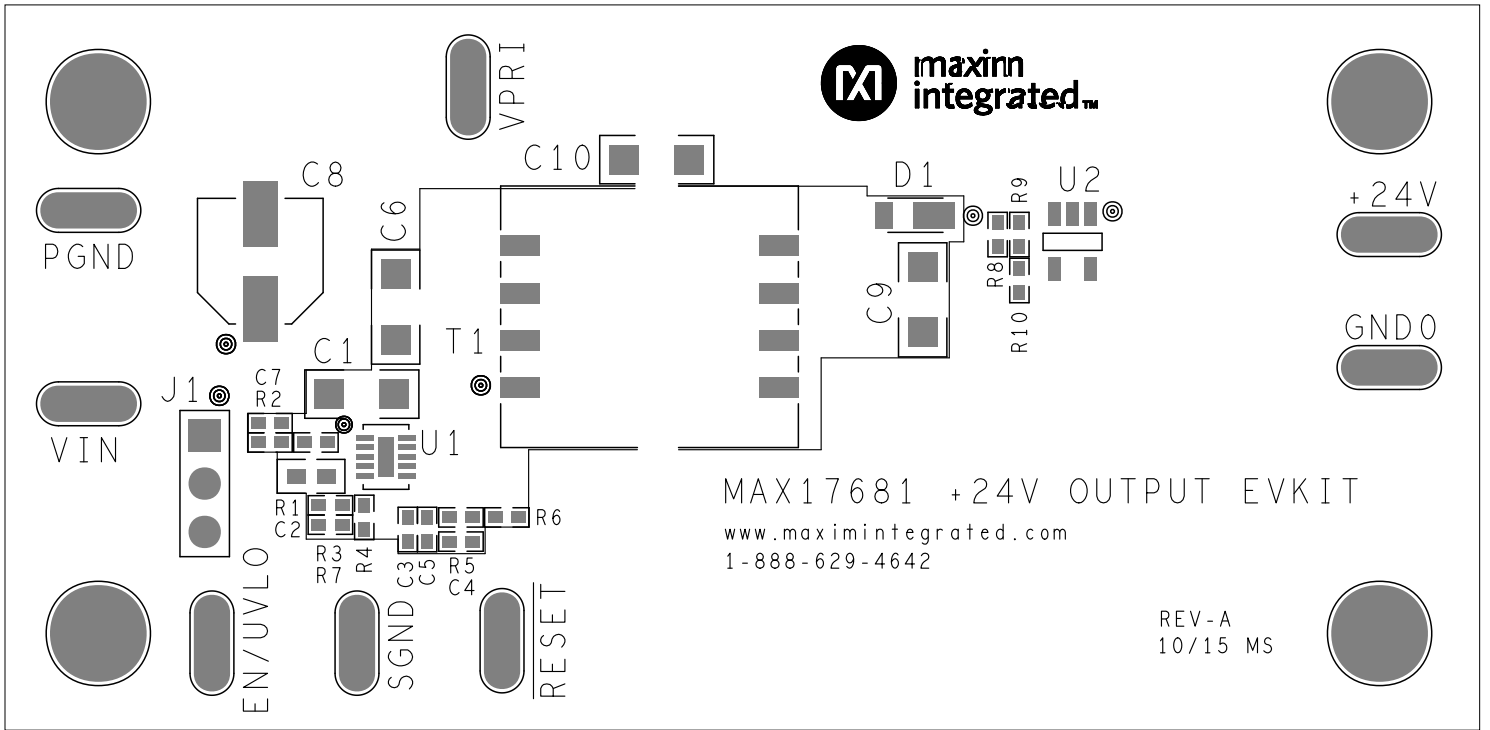

**TOP SILKSCREEN**



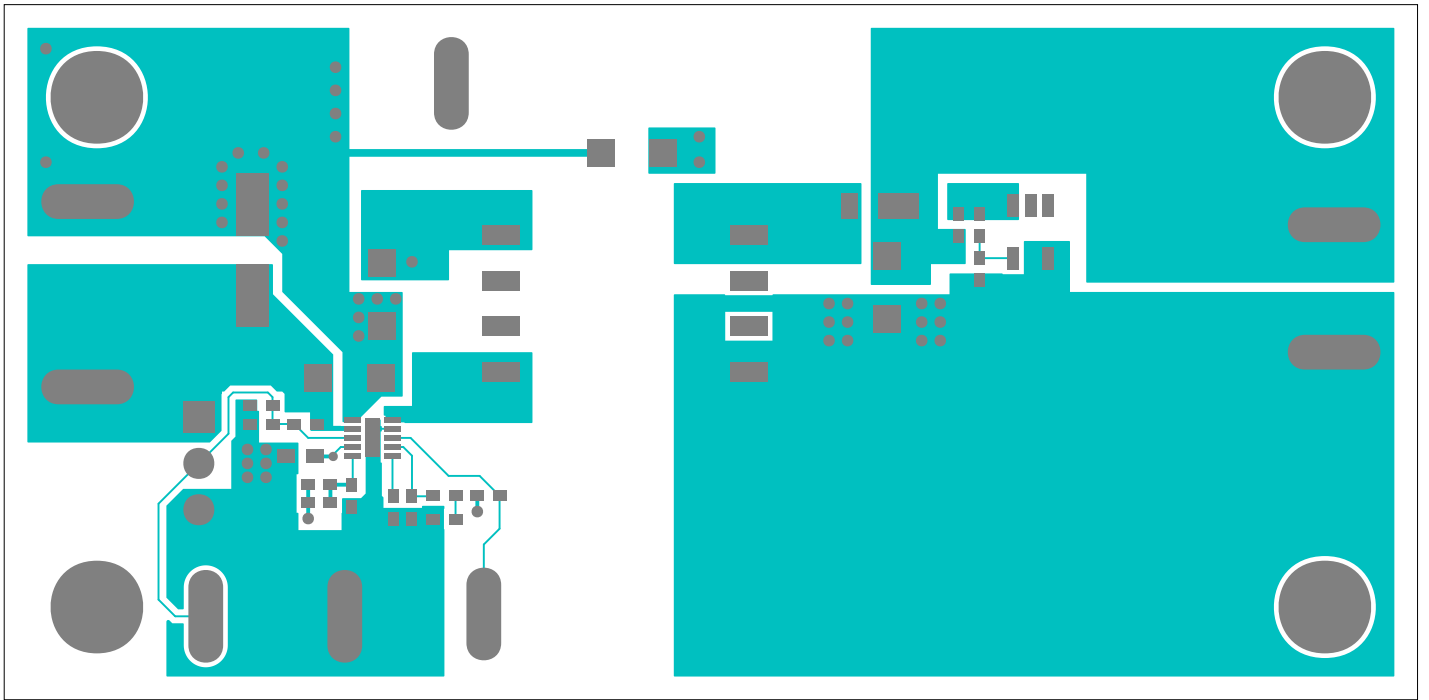

**TOP**

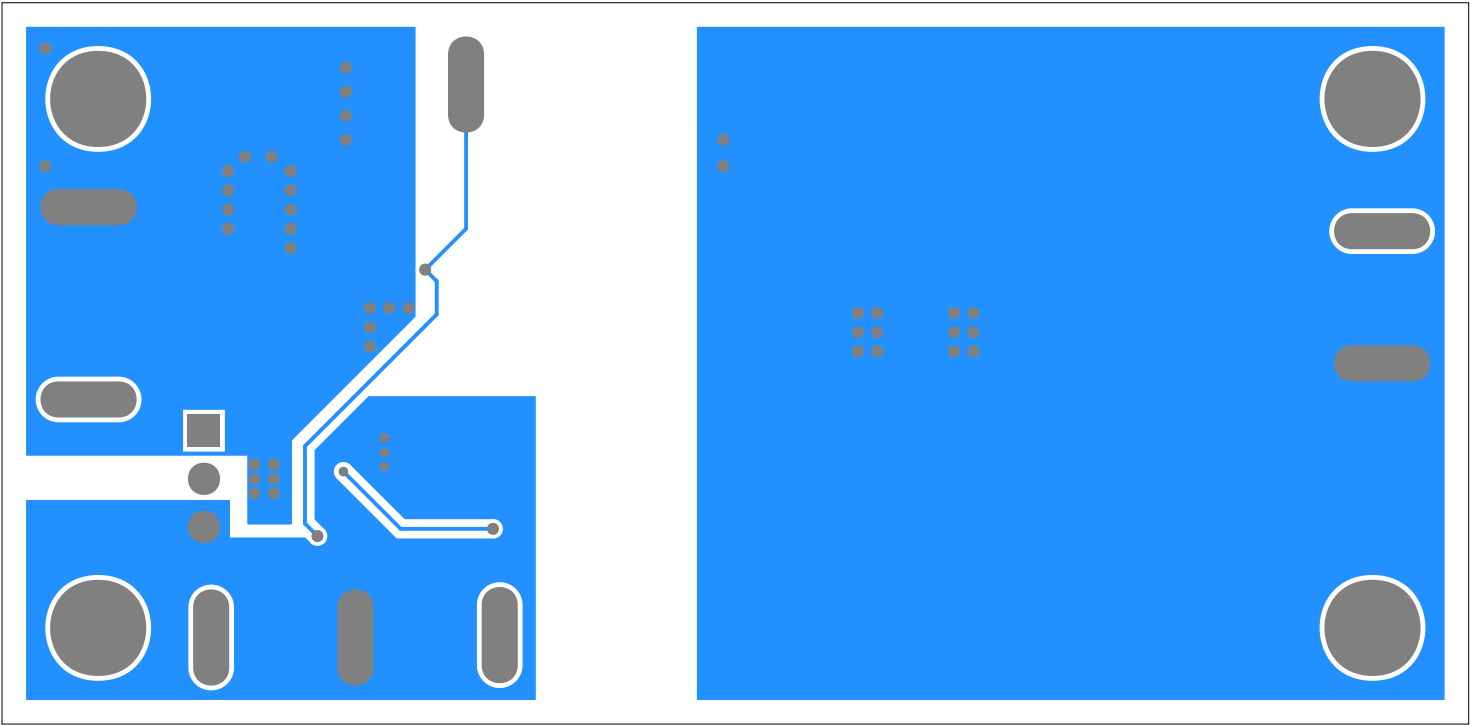

**BOTTOM**

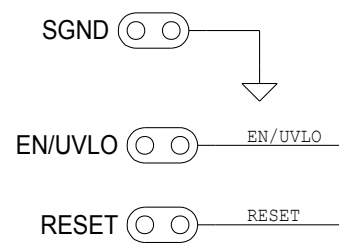
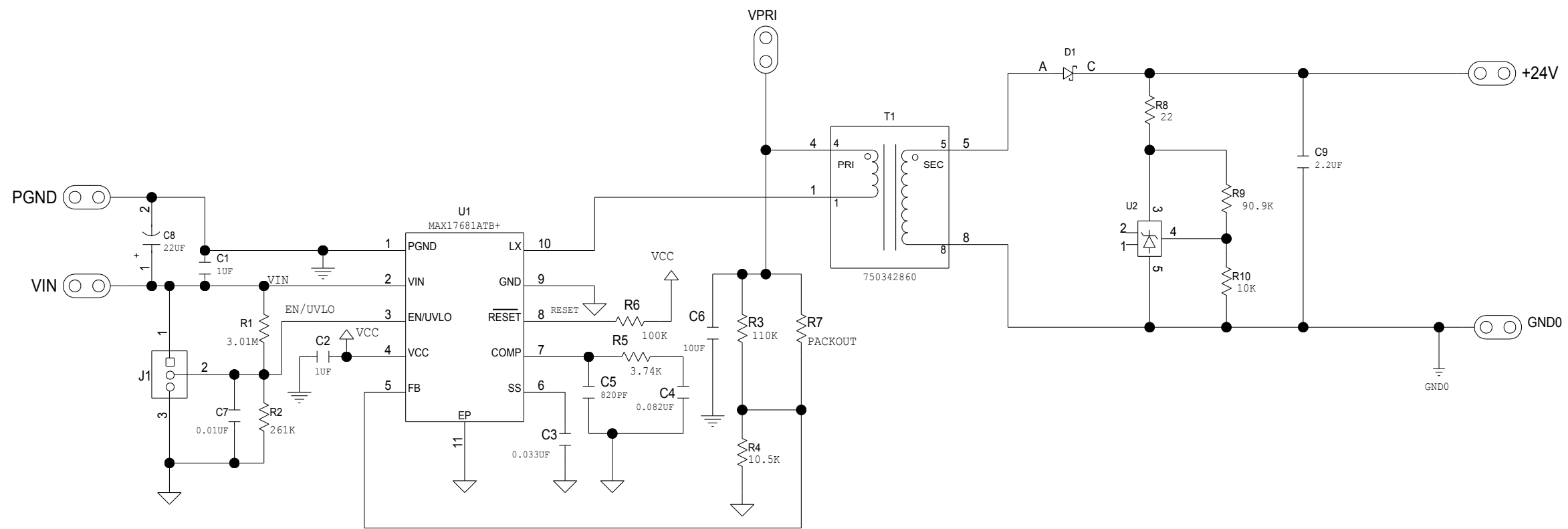



Компания «ЭлектроПласт» предлагает заключение долгосрочных отношений при поставках импортных электронных компонентов на взаимовыгодных условиях!

Наши преимущества:

- Оперативные поставки широкого спектра электронных компонентов отечественного и импортного производства напрямую от производителей и с крупнейших мировых складов;
- Поставка более 17-ти миллионов наименований электронных компонентов;
- Поставка сложных, дефицитных, либо снятых с производства позиций;
- Оперативные сроки поставки под заказ (от 5 рабочих дней);
- Экспресс доставка в любую точку России;
- Техническая поддержка проекта, помощь в подборе аналогов, поставка прототипов;
- Система менеджмента качества сертифицирована по Международному стандарту ISO 9001;
- Лицензия ФСБ на осуществление работ с использованием сведений, составляющих государственную тайну;
- Поставка специализированных компонентов (Xilinx, Altera, Analog Devices, Intersil, Interpoint, Microsemi, Aeroflex, Peregrine, Syfer, Eurofarad, Texas Instrument, Miteq, Cobham, E2V, MA-COM, Hittite, Mini-Circuits, General Dynamics и др.);

Помимо этого, одним из направлений компании «ЭлектроПласт» является направление «Источники питания». Мы предлагаем Вам помощь Конструкторского отдела:

- Подбор оптимального решения, техническое обоснование при выборе компонента;
- Подбор аналогов;
- Консультации по применению компонента;
- Поставка образцов и прототипов;
- Техническая поддержка проекта;
- Защита от снятия компонента с производства.



#### Как с нами связаться

**Телефон:** 8 (812) 309 58 32 (многоканальный)

**Факс:** 8 (812) 320-02-42

**Электронная почта:** [org@eplast1.ru](mailto:org@eplast1.ru)

**Адрес:** 198099, г. Санкт-Петербург, ул. Калинина, дом 2, корпус 4, литера А.