

Terminal Junction Systems

MIL-T-81714 Series I Class D



MIL-T-81714 Series I Junction Modules

QPL-approved MIL-T-81714 modules and MIL-C-39029/1 contacts are available in four standard sizes accommodating 12-26 AWG wires in both feedback and feedthru types with full a selection of bussing arrangements. The complete MIL-T-81714 Series I Terminal Junction System includes the following products.



Feedback Modules
Feedthru Modules



Electronic Modules



Ground Modules



Single In-Line Splices
Dual In-Line Splices
Electronic Splices



Mounting Tracks

Key Features and Benefits

Integral Socket/Bus Bar

The patented integral socket/bus bar assembly provides superior electrical characteristics and assures mechanical integrity over a long product life. This unique design totally eliminates all solder or welded joints which could cause variation in electrical and/or mechanical performance

Integral Contacts

Integral female contacts and bus bar have no mechanical functions- only the electrical conductivity function and are highly conductive alloy for optimum electrical performance.

Split Socket Design

Split Socket Design, conforming to the mating pin diameter, provides peripheral surface wipe and contact, while utilizing the maximum mating surfaces of pin and socket.

High Density Modules

A recently introduced series of high density modules which conform to all dimensional and performance requirements of MIL-T-81714/17 is now available from Amphenol Pcd. The high density modules accept 21 size 22 contacts in a compact 3x7 configuration, with a wide variety of bus arrangements. The construction features one-piece screw machine contacts with a split socket design for maximum performance. Contacts are securely packaged within a polyetherimide housing.

Class D Modules System

Amphenol Pcd was the first supplier to qualify module and track systems to high performance MIL-T-81714 Series I Class D requirements. Class D systems combine the maximum high temperature and high fluid resistance performance parameters previously divided among three module classes A,B, and C.

Electronic Splices

TJSE electronic modules can be supplied with a wide variety of diodes, resistors, capacitors, and fuses within the splice itself. TJSE electronic splices meet the electrical parameters of MIL-81714/24 and allow customers to incorporate system modifications into a wire bundle, avoiding changes in panles modules.



Military Qualified, QPL-Listed

MIL-T-81714 Series I, Class D

Class D Feedback Modules

| Military P/N | Amphenol Pcd P/N | Page |
|---------------|------------------|------|
| M81714/1-DA1 | TJM122701 | 36 |
| M81714/1-DB1 | TJM122702 | 36 |
| M81714/1-DB2 | TJM122703 | 36 |
| M81714/1-DB3 | TJM122704 | 36 |
| M81714/1-DC1 | TJM122705 | 36 |
| M81714/1-DC2 | TJM122706 | 36 |
| M81714/1-DC3 | TJM122710 | 36 |
| M81714/1-DC4 | TJM122712 | 36 |
| M81714/1-DD1 | TJM122707 | 36 |
| M81714/1-DD2 | TJM122711 | 36 |
| M81714/1-DE1 | TJM122708 | 36 |
| | | |
| M81714/2-DA1 | TJM120701 | 37 |
| M81714/2-DB1 | TJM120702 | 37 |
| M81714/2-DB2 | TJM120703 | 37 |
| M81714/2-DB3 | TJM120704 | 37 |
| M81714/2-DC1 | TJM120705 | 37 |
| M81714/2-DC2 | TJM120706 | 37 |
| M81714/2-DC3 | TJM120710 | 37 |
| M81714/2-DC4 | TJM120712 | 37 |
| M81714/2-DD1 | TJM120707 | 37 |
| M81714/2-DD2 | TJM120711 | 37 |
| M81714/2-DE1 | TJM120708 | 37 |
| | | |
| M81714/3-DA1 | TJM116701 | 38 |
| M81714/3-DB1 | TJM116702 | 38 |
| M81714/3-DB2 | TJM116703 | 38 |
| M81714/3-DC1 | TJM116705 | 38 |
| M81714/3-DC2 | TJM116706 | 38 |
| M81714/3-DD1 | TJM116707 | 38 |
| | | |
| M81714/4-DA1 | TJM112701 | 39 |
| M81714/4-DB1 | TJM112702 | 39 |
| M81714/4-DB2 | TJM112703 | 39 |
| M81714/4-DC1 | TJM112705 | 39 |
| M81714/4-DC2 | TJM112706 | 39 |
| M81714/4-DD1 | TJM112707 | 39 |
| | | |
| M81714/17-D30 | TJHD22700 | 40 |
| M81714/17-D31 | TJHD22701 | 40 |
| M81714/17-D32 | TJHD22702 | 40 |
| M81714/17-D33 | TJHD22703 | 40 |
| M81714/17-D34 | TJHD22704 | 40 |
| M81714/17-D35 | TJHD22705 | 40 |
| M81714/17-D36 | TJHD22706 | 40 |
| M81714/17-D37 | TJHD22707 | 40 |
| M81714/17-D38 | TJHD22708 | 40 |
| M81714/17-D39 | TJHD22709 | 40 |
| M81714/17-D40 | TJHD22710 | 40 |
| M81714/17-D42 | TJHD22712 | 40 |
| M81714/17-D43 | TJHD22713 | 40 |
| M81714/17-D44 | TJHD22714 | 40 |
| M81714/17-D45 | TJHD22715 | 40 |

Class D Feedthru Modules

| Military P/N | Amphenol Pcd P/N | Page |
|--------------|------------------|------|
| M81714/6-DA1 | TJM222701 | 36 |
| M81714/6-DB1 | TJM222702 | 36 |
| M81714/6-DB2 | TJM222703 | 36 |
| M81714/6-DB3 | TJM222704 | 36 |
| M81714/6-DC1 | TJM222705 | 36 |
| M81714/6-DC2 | TJM222706 | 36 |
| M81714/6-DD1 | TJM222707 | 36 |
| M81714/6-DE1 | TJM222708 | 36 |
| M81714/6-DJ1 | TJM222709 | 36 |
| | | |
| M81714/7-DA1 | TJM220701 | 37 |
| M81714/7-DB1 | TJM220702 | 37 |
| M81714/7-DB2 | TJM220703 | 37 |
| M81714/7-DB3 | TJM220704 | 37 |
| M81714/7-DC1 | TJM220705 | 37 |
| M81714/7-DC2 | TJM220706 | 37 |
| M81714/7-DD1 | TJM220707 | 37 |
| M81714/7-DE1 | TJM220708 | 37 |
| M81714/7-DJ1 | TJM220709 | 37 |
| | | |
| M81714/8-DA1 | TJM216701 | 38 |
| M81714/8-DB1 | TJM216702 | 38 |
| M81714/8-DB2 | TJM216703 | 38 |
| M81714/8-DC1 | TJM216705 | 38 |
| M81714/8-DC2 | TJM216706 | 38 |
| M81714/8-DD1 | TJM216707 | 38 |
| M81714/8-DG1 | TJM216708 | 38 |
| M81714/8-DH1 | TJM216709 | 38 |
| | | |
| M81714/9-DA1 | TJM212701 | 39 |
| M81714/9-DB2 | TJM212702 | 39 |
| M81714/9-DB3 | TJM212703 | 39 |
| M81714/9-DC1 | TJM212705 | 39 |
| M81714/9-DC2 | TJM212706 | 39 |
| M81714/9-DD1 | TJM212707 | 39 |
| M81714/9-DH1 | TJM212709 | 39 |

Terminal Junction Modules

M81714/1, /6 Series I Size 22 Class D



Operating Range

Temperature:
-65°C to 200°C

Insulation Resistance:
5000 Megaohms @ 25°C

Dielectric Withstanding Voltage:
1500 VRMS at Sea Level
200 VRMS at 100,000 ft.

Current Rating
5 Amps

Vibration & Shock:
MIL-T-81714 Paragraph
3.5.5 and 3.5.8

Materials

Module Body:
Polyetherimide per ASTM-D5205

Grommet:
Silicone Blend Elastomer per A-A-59588

Contact Retainers:
Stainless Steel

Internal Socket Contacts:
Copper Alloy, Hard Gold Plated in
Accordance with MIL-G-45204

Accepts Multiple Wire Sizes:
Size 22, 24, 26 AWG

Amphenol Pcd Terminal Junction Modules

| Bussing Configurations | Feedback | | Feedthru | | Contact | | |
|------------------------|--------------|-----------|--------------|-----------|---------|-------------------|------------|
| | Military P/N | APCD P/N | Military P/N | APCD P/N | QTY* | Size ¹ | P/N M39029 |
| | M81714/1-DA1 | TJM122701 | M81714/6-DA1 | TJM222701 | 10 | 16/22 | /1-100 |
| | M81714/1-DB1 | TJM122702 | M81714/6-DB1 | TJM222702 | 10 | 16/22 | /1-100 |
| | M81714/1-DB2 | TJM122703 | M81714/6-DB2 | TJM222703 | 10 | 16/22 | /1-100 |
| | M81714/1-DB3 | TJM122704 | M81714/6-DB3 | TJM222704 | 10 | 16/22 | /1-100 |
| | M81714/1-DC1 | TJM122705 | M81714/6-DC1 | TJM222705 | 10 | 16/22 | /1-100 |
| | M81714/1-DC2 | TJM122706 | M81714/6-DC2 | TJM222706 | 10 | 16/22 | /1-100 |
| | M81714/1-DC3 | TJM122710 | | | 10 | 16/22 | /1-100 |
| | M81714/1-DC4 | TJM122712 | | | 10 | 16/22 | /1-100 |
| | M81714/1-DD1 | TJM122707 | M81714/6-DD1 | TJM222707 | 10 | 16/22 | /1-100 |
| | M81714/1-DD2 | TJM122711 | | | 10 | 16/22 | /1-100 |
| | M81714/1-DE1 | TJM122708 | M81714/6-DE1 | TJM222708 | 10 | 16/22 | /1-100 |
| | | | M81714/6-DJ1 | TJM222709 | 10 | 16/22 | /1-100 |

* Contact quantity for feedthru is double feedback. Quantity figure denotes number of contacts accommodated by module. Modules are supplied with one additional spare contact and sealing plug.
¹ Mating Pin / Wire Barrel

Terminal Junction Module Dimensions

Feedback Dimensions



Feedthru Dimensions



M81714/2, /7

Series I Size 20 Class D

Terminal Junction Modules

Operating Range

Temperature:

-65°C to 200°C

Insulation Resistance:

5000 Megaohms @ 25°C

Dielectric Withstanding Voltage:

1500 VRMS at Sea Level

200 VRMS at 100,000 ft.

Current Rating

7.5 Amps

Vibration & Shock:

MIL-T-81714 Paragraph

3.5.5 and 3.5.8

Materials

Module Body:

Polyetherimide per ASTM-D5205

Grommet:

Silicone Blend Elastomer per A-A-59588

Contact Retainers:

Stainless steel

Socket Contacts:

Copper Alloy, Hard Gold Plated in

Accordance with MIL-G-45204

Accepts Multiple Wire Sizes:

Size 20, 22, 24 AWG



Amphenol Pcd Terminal Junction Modules

| Bussing Configurations | Feedback | | Feedthru | | QTY* | Size ¹ | P/N M39029 |
|------------------------|--------------|-----------|--------------|-----------|------|-------------------|------------|
| | Military P/N | APCD P/N | Military P/N | APCD P/N | | | |
| | M81714/2-DA1 | TJM120701 | M81714/7-DA1 | TJM220701 | 10 | 16/20 | /1-101 |
| | M81714/2-DB1 | TJM120702 | M81714/7-DB1 | TJM220702 | 10 | 16/20 | /1-101 |
| | M81714/2-DB2 | TJM120703 | M81714/7-DB2 | TJM220703 | 10 | 16/20 | /1-101 |
| | M81714/2-DB3 | TJM120704 | M81714/7-DB3 | TJM220704 | 10 | 16/20 | /1-101 |
| | M81714/2-DC1 | TJM120705 | M81714/7-DC1 | TJM220705 | 10 | 16/20 | /1-101 |
| | M81714/2-DC2 | TJM120706 | M81714/7-DC2 | TJM220706 | 10 | 16/20 | /1-101 |
| | M81714/2-DC3 | TJM120710 | | | 10 | 16/20 | /1-101 |
| | M81714/2-DC4 | TJM120712 | | | 10 | 16/20 | /1-101 |
| | M81714/2-DD1 | TJM120707 | M81714/7-DD1 | TJM220707 | 10 | 16/20 | /1-101 |
| | M81714/2-DD2 | TJM120711 | | | 10 | 16/20 | /1-101 |
| | M81714/2-DE1 | TJM120708 | M81714/7-DE1 | TJM220708 | 10 | 16/20 | /1-101 |
| | | | M81714/7-DJ1 | TJM220709 | 10 | 16/20 | /1-101 |

* Contact quantity for feedthru is double feedback. Quantity figure denotes number of contacts accommodated by module. Modules are supplied with one additional spare contact and sealing plug.
¹ Mating Pin / Wire Barrel

Terminal Junction Module Dimensions

Feedback Dimensions



Feedthru Dimensions

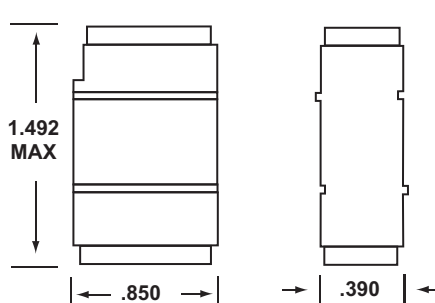

Amphenol Pcd

Terminal Junction Modules

M81714/3, /8 Series I Size 16 Class D



Operating Range

Temperature:
-65°C to 200°C

Insulation Resistance:
5000 Megaohms @ 25°C

Dielectric Withstanding Voltage:
1500 VRMS at Sea Level
200 VRMS at 100,000 ft.

Current Rating
13 Amps

Vibration & Shock:
MIL-T-81714 Paragraph
3.5.5 and 3.5.8

Materials

Module Body:
Polyetherimide per ASTM-D5205

Grommet:
Silicone Blend Elastomer per A-A-59588

Contact Retainers:
Stainless Steel

Socket Contacts:
Copper Alloy, Hard Gold Plated in
Accordance with MIL-G-45204

Accepts Multiple Wire Sizes:
Size 16, 18, 20 AWG

Amphenol Pcd Terminal Junction Modules

| Bussing Configurations | Feedback | | Feedthru | | Contact | | |
|------------------------|--------------|-----------|--------------|-----------|---------|-------------------|------------|
| | Military P/N | APCD P/N | Military P/N | APCD P/N | QTY* | Size ¹ | P/N M39029 |
| | M81714/3-DA1 | TJM116701 | M81714/8-DA1 | TJM216701 | 8 | 14/16 | /1-102 |
| | M81714/3-DB1 | TJM116702 | M81714/8-DB1 | TJM216702 | 8 | 14/16 | /1-102 |
| | M81714/3-DB2 | TJM116703 | M81714/8-DB2 | TJM216703 | 8 | 14/16 | /1-102 |
| | M81714/3-DC1 | TJM116705 | M81714/8-DC1 | TJM216705 | 8 | 14/16 | /1-102 |
| | M81714/3-DC2 | TJM116706 | M81714/8-DC2 | TJM216706 | 8 | 14/16 | /1-102 |
| | M81714/3-DD1 | TJM116707 | M81714/8-DD1 | TJM216707 | 8 | 14/16 | /1-102 |
| | | | M81714/8-DG1 | TJM216708 | 8 | 14/16 | /1-102 |
| | | | M81714/8-DH1 | TJM216709 | 8 | 14/16 | /1-102 |

* Contact quantity for feedthru is double feedback. Quantity figure denotes number of contacts accommodated by module. Modules are supplied with one additional spare contact and sealing plug.
¹ Mating Pin / Wire Barrel

Terminal Junction Module Dimensions

Feedback Dimensions



Feedthru Dimensions



M81714/4, /9

Series I Size 12 Class D

Terminal Junction Modules

Operating Range

Temperature:

-65°C to 200°C

Insulation Resistance:

5000 Megaohms @ 25°C

Dielectric Withstanding Voltage:

1500 VRMS at Sea Level

200 VRMS at 100,000 ft.

Current Rating

23 Amps

Vibration & Shock:

MIL-T-81714 Paragraph

3.5.5 and 3.5.8

Materials

Module Body:

Polyetherimide per ASTM-D5205

Grommet:

Silicone Blend Elastomer per A-A-59588

Contact Retainers:

Stainless steel

Internal Socket Contacts:

Copper Alloy, Hard Gold Plated in

Accordance with MIL-G-45204

Accepts Multiple Wire Sizes:

Size 12, 14 AWG



Terminal Junction Modules

| Bussing Configurations | Feedback | | Feedthru | | Contact | | |
|------------------------|--------------|-----------|---------------|-----------|---------|-------------------|------------|
| | Military P/N | APCD P/N | Military P/N | APCD P/N | QTY* | Size ¹ | P/N M39029 |
| | M81714/4-DA1 | TJM112701 | M81714/9-DA1 | TJM212701 | 8 | 12/12 | /1-103 |
| | M81714/4-DB1 | TJM112702 | M81714/9-DB1 | TJM212702 | 8 | 12/12 | /1-103 |
| | M81714/4-DB2 | TJM112703 | M81714/9-DB2 | TJM212703 | 8 | 12/12 | /1-103 |
| | M81714/4-DC1 | TJM112705 | M/81714/9-DC1 | TJM212705 | 8 | 12/12 | /1-103 |
| | M81714/4-DC2 | TJM112706 | M81714/9-DC2 | TJM212706 | 8 | 12/12 | /1-103 |
| | M81714/4-DD1 | TJM112707 | M81714/9-DD1 | TJM212707 | 8 | 12/12 | /1-103 |
| | | | M81714/9-DH1 | TJM212709 | 8 | 12/12 | /1-103 |

* Contact quantity for feedthru is double feedback. Quantity figure denotes number of contacts accommodated by module. Modules are supplied with one additional spare contact and sealing plug.

¹ Mating Pin / Wire Barrel

Terminal Junction Module Dimensions

Feedback Dimensions

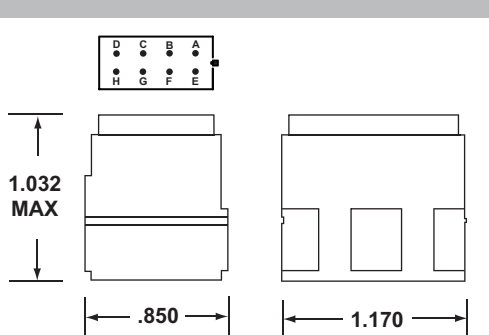

Feedthru Dimensions

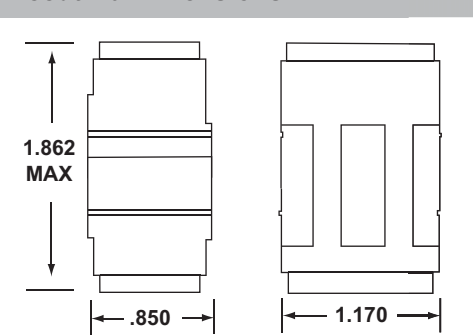

Amphenol Pcd

M81714/17 High Density Modules

Series I Size 22D Class D

Terminal Junction Modules



Operating Range

Temperature:
-65°C to 200°C

Insulation Resistance:
5000 Megaohms @ 25°C

Dielectric Withstanding Voltage:
1000 VRMS at Sea Level
200 VRMS at 110,000 ft.

Current Rating
5 Amps

Vibration & Shock:
MIL-T-81714 Paragraph
3.5.5 and 3.5.8

Materials

Module Body:
Polyetherimide per ASTM-D5205

Grommet:
Silicone Blend Elastomer per A-A-59588

Contact Retainers:
Stainless Steel

Internal Socket Contacts:
Copper Alloy, Hard Gold Plated in
Accordance with MIL-G-45204

Accepts Multiple Wire Sizes:
Size 22, 26 AWG

Amphenol Pcd Terminal Junction Modules

| Bussing Configurations | Feedback | |
|------------------------|---------------|-----------|
| | Military P/N | APCD P/N |
| | M81714/17-D30 | TJHD22700 |
| | M81714/17-D31 | TJHD22701 |
| | M81714/17-D32 | TJHD22702 |
| | M81714/17-D33 | TJHD22703 |
| | M81714/17-D34 | TJHD22704 |
| | M81714/17-D35 | TJHD22705 |
| | M81714/17-D36 | TJHD22706 |
| | M81714/17-D37 | TJHD22707 |

| Bussing Configurations | Feedback | |
|------------------------|---------------|-----------|
| | Military P/N | APCD P/N |
| | M81714/17-D38 | TJHD22708 |
| | M81714/17-D39 | TJHD22709 |
| | M81714/17-D40 | TJHD22710 |
| | M81714/17-D42 | TJHD22712 |
| | M81714/17-D43 | TJHD22713 |
| | M81714/17-D44 | TJHD22714 |
| | M81714/17-D45 | TJHD22715 |

Contacts Supplied: M39029/1-507 Qty 22

Terminal Junction Module Dimensions



Feedback Dimensions



Bussing Configuration



Contacts Supplied: M39029/1-507
Quantity Supplied: 22

M81714/27 Ground Stud Modules

Series II Size 22, 20, 16, 12, Class D

Operating Range

Temperature:

-65°C to 200°C

Current Rating

5 Amps (Size 22)

7.5 Amps (Size 20)

13 Amps (Size 16)

23 Amps (Size 12)

Vibration & Shock:

MIL-T-81714 Paragraph

3.5.5 and 3.5.8

Materials

Module Body:

Polyetherimide per ASTM-D5205

Grommet:

Silicone Blend Elastomer per A-A-59588

Mounting Stud:

Copper Alloy, Gold Plated per SAE-AMS-2422.

Contact Retainers:

Stainless Steel

Internal Socket Contacts:

Copper Alloy, Hard Gold Plated in Accordance with MIL-G-45204

Terminal Junction Modules



Terminal Grounding Modules Part Numbers

| Part Numbers | | Contact | | |
|-------------------------|-----------|---------|-------------------|------------|
| Military Equivalent P/N | APCD P/N | QTY* | Size ¹ | P/N M39029 |
| M81714/27-22 | TJG122701 | 10 | 16/22 | /1-100 |
| M81714/27-20 | TJG120701 | 10 | 16/20 | /1-101 |
| M81714/27-16 | TJG116701 | 8 | 14/16 | /1-102 |
| M81714/27-12 | TJG112701 | 8 | 12/12 | /1-103 |

* Mating End/ Wire Barrel

¹ Quantity figure denotes number of contacts accommodated by module. Modules are supplied with two additional spare contacts and sealing plugs

Product Description

Multi-contact grounding/bus connection modules are provided with an integral threaded grounding stud. The stud is electrically and mechanically common to all internal contacts of the module.

Electrical connection and mechanical mounting are achieved through a single #10-32 stud. The modules are dimensional identical to the equivalent MIL-T-81714/27 grounding stud modules.

Direct mounting to a ground plane or ground wire with the terminal lug creates a convenient multi-wire sealed grounding device.

Direct attachment to a bus bar transforms the device into a bus connection module for multi-contact power distribution, sensing or metering.

All modules are furnished with complete mounting hardware.

Terminal Junction Module Dimensions

Top View

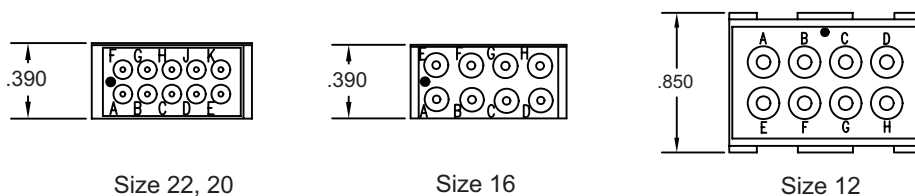

Size 22, 20

Size 16

Size 12

Side View

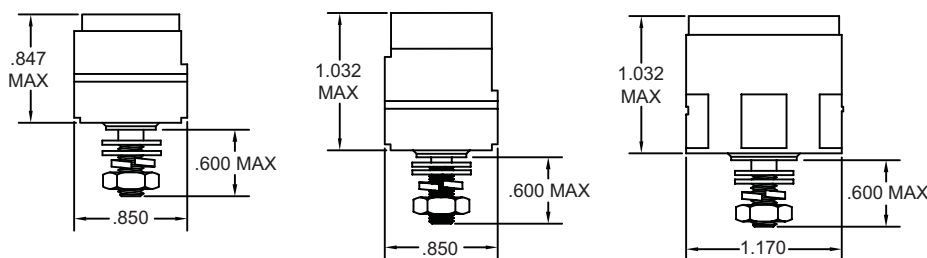

Size 22, 20

Size 16

Size 12

Amphenol Pcd

Electronic Terminal Junction Modules

MIL-T-81714/26 Compatible Class D

Terminal Junction Modules



Operating Range

Temperature:

-65°C to 200°C*

Insulation Resistance:

5000 Megaohms Min. @ 25°C*

Dielectric Withstanding Voltage:

1500 VRMS at Sea Level

200 VRMS at 100,000 ft.*

Vibration & Shock:

Per MIL-T-81714

Paragraph 3.5.5 & 3.5.9*

Current Rating:

7.5 amps*

Materials

Module Body:

Polyetherimide per ASTM-D-5205

Grommet:

Silicone Rubber per A-A-59588

Contact Retainers:

Stainless Steel

Internal Contact:

Copper Alloy, Gold Finish

* May vary due to internal electronic component

Amphenol Pcd Terminal Junction Module

Product Description

Electronic Terminal Junction modules meet all dimensional and performance requirements of M81714/26 and are specifically developed for electronic component packaging. Available for size 20 and 22 contacts, these modules function as highly efficient and reliable Electronic component packages. They improve system efficiency and density by permitting various electronic components such as diodes, resistors, fuses, and capacitors, which usually take up valuable space elsewhere in the system, to be securely packaged within the module housing.

Amphenol Pcd electronic modules offer significant design, material and construction improvements over competitive modules. Hand soldering operations have been completely eliminated. Electronic components are encapsulated in a semi-rigid elastomer that provides electrical spacing and insulation as well as shock and vibration protection.

Typical commercially available diode configurations are indicated on this page. A broad variety of additional configurations are available, and modules can be customized to meet specific customer designs. Please contact Amphenol Pcd to review requirements and discuss available options.

| Circuit Diagram | APCD P/N | Diode P/N | Quantity |
|-----------------|-----------|-------------|----------|
| | TJE120810 | JANTX1N5552 | 5 |
| | TJE120811 | JANTX1N5552 | 4 |
| | TJE120815 | 1N4005 | 2 |
| | TJE120998 | BYW56 | 2 |
| | TJE120999 | BYW56 | 2 |

Terminal Junction Module Dimensions

Top View



Side View



Electronic Terminal Junction Modules

MIL-T-81714/26 Compatible Class D

Terminal Junction Modules

Amphenol Pcd's Electronic Terminal Junction Modules are available with a variety of components and in a wide range of configurations. Components available include but are not limited to diodes, resistors, fuses, capacitors, thyristors, and inductors, and are also available with multiple components within one module. The following are currently available Electronic Terminal Junction Modules, although there are new configurations produced regularly and customized components are also available.



Amphenol Pcd Electronic Terminal Junction Modules

| Circuit Diagram | APCD P/N | Part | Part P/N | Quantity |
|-----------------|-----------|-----------|-------------|----------|
| | TJE120514 | Capacitor | 620pF | 1 |
| | TJE120816 | Diode | IN4003 | 3 |
| | TJE120817 | Diode | IN4003 | 2 |
| | TJE120818 | Diode | IN4003 | 3 |
| | TJE120819 | Diode | IN4003 | 3 |
| | TJE120820 | Diode | IN4003 | 3 |
| | TJE120822 | Diode | IN4007 | 5 |
| | TJE120824 | Diode | JANTX1N5618 | 5 |
| | TJE120826 | Diode | IN4006 | 2 |
| | TJE120827 | Diode | JANTX1N5552 | 2 |
| | TJE120828 | Diode | JANTX1N5618 | 2 |
| | TJE120829 | Diode | 1N5618 | 2 |
| | TJE120831 | Diode | 1N5618 | 2 |
| | TJE120833 | Diode | 1N5418 | 2 |

| Circuit Diagram | APCD P/N | Part | Part P/N | Quantity |
|-----------------|-----------|----------|--------------------------|----------|
| | TJE120900 | Resistor | 10 K Ω , 1/8 W | 5 |
| | TJE120902 | Resistor | 150K Ω , 1/8 W | 5 |
| | TJE120903 | Resistor | 33 Ω , 1/4 W | 2 |
| | TJE120904 | Resistor | 1K Ω , 1/8 W | 2 |
| | TJE120905 | Resistor | 1K Ω , 1/2 W | 2 |
| | TJE120906 | Resistor | 150 Ω , 1/2 W | 1 |
| | TJE120907 | Resistor | 180 Ω , 1/2 W | 1 |
| | TJE120908 | Resistor | Various Ω , 1/2 W | 5 |
| | TJE120920 | Resistor | 54K, 6K Ω , 1/2W | 2 |
| | TJE120921 | Resistor | 500K Ω , 1 W | 5 |
| | TJE120922 | Resistor | Various Ω , 1/2 W | 5 |
| | TJE120924 | Resistor | 1K Ω , 1/4 W | 4 |
| | TJE120927 | Fuse | 1 AMP | 5 |
| | TJE120928 | Resistor | 1.3K Ω , 1/2 W | 5 |

Terminal Junction Splices

Single/ Dual/ Diode M81714/11, /12,/24 Series I

Terminal Junction Splices



Operating Range

Temperature:
-65°C to 200°C

Insulation Resistance:
5000 Megaohms Min.

Dielectric Withstanding Voltage:
1500 VRMS at Sea Level
200 VRMS at 100,000 ft.

Vibration & Shock:
Per AS-81714
Paragraph 3.5.5 & 3.5.8

Materials

Insulator Body:
Polyetherimide per ASTM-D-5205

Grommet:
Silicone Rubber per A-A-59588

Internal Contact:
Copper Alloy, Gold Finish
Accordance with MIL-G-45204

Product Description

Single and Dual Splices and Electronic Splices are designed to provide a quick and efficient solution to customer wiring requirements.

Single and Dual Wire Splices meet MIL-T-81714/11 & 12 requirements and are highly resistant to temperature and fluids.

TJSE electronic modules can be supplied with a wide variety of diodes, resistors, capacitors, and fuses within the splice itself. TJSE electronic splices meet the electronic parameters of MIL-81714/24 and allow customers to incorporate system modifications into a wire bundle, avoiding changes in panels or boards.

Typical examples are represented to the right, but customer specific designs are welcomed, and an extensive list of existing splices are available on the next page.

Single Wire Splices

| | Contacts | | Part Numbers | | |
|--|---------------|-----------|--------------|-------|--------------|
| | Military P/N | APCD P/N | Quantity | Size* | Part No. |
| | M81714/11-22D | TJS322700 | 2 | 16/22 | M39029/1-100 |
| | M81714/11-20D | TJS320700 | 2 | 16/20 | M39029/1-101 |
| | M81714/11-12D | TJS316700 | 2 | 14/16 | M39029/1-102 |
| | M81714/11-16D | TJS312700 | 2 | 12/12 | M39029/1-103 |

Dual Wire Splices

| Bussing Type | Part Numbers | | Contacts | | Diameter | |
|--------------|---------------|-----------|----------|------------------|----------|------|
| | MIL P/N 81714 | APCD P/N | Quantity | Size* P/N M39029 | A | B |
| | /12-22D-1 | TJS322701 | 4 | 16/22 /1-100 | .400 | .275 |
| | /12-20D-1 | TJS320701 | 4 | 16/20 /1-101 | .400 | .275 |
| | /12-16D-1 | TJS316701 | 4 | 14/16 /1-102 | .500 | .300 |
| | /12-22D-2 | TJS322702 | 4 | 16/22 /1-100 | .400 | .275 |
| | /12-20D-2 | TJS320702 | 4 | 16/20 /1-101 | .400 | .275 |
| | /12-16D-2 | TJS316702 | 4 | 14/16 /1-102 | .500 | .300 |

Electronic Splices

| Circuit Type | Part Numbers | | Diode | | Contacts | |
|--------------|--------------|-------------|----------|-------|----------|------------|
| | APCD P/N | Diode P/N | Quantity | Size* | Quantity | P/N M39029 |
| | TJSE22707 | JANTX1N5622 | 1 | 16/22 | 4 | 1-100 |
| | TJSE20705 | JANTX1N5622 | 1 | 16/20 | 4 | 1-101 |
| | TJSE22709 | JANTX1N5622 | 2 | 16/22 | 4 | 1-100 |
| | TJSE20705 | JANTX1N5622 | 2 | 16/20 | 4 | 1-101 |

*Mating Pin Wire Barrel

Relay Socket Dimensions

Single Splice

1.552 Max
.250 ± .025 Diameter

Double Splice

Dimension C
Size 20/22 1.552 Max
Size 16 1.922 Max

Electronic Splice

2.000 Max
.275 Max

Electronic Terminal Junction Splices

MIL-T-81714/24 Compatible Class D

Terminal Junction Modules

Amphenol Pcd's Electronic Terminal Junction Splices are available with a variety of components and in a wide range of configurations. Components available include but are not limited to diodes, resistors, fuses, capacitors, thyristors, and inductors, and are also available with multiple components within one module. The following are currently available Electronic Terminal Junction Splices, although there are new configurations produced regularly and customized components are also available.



Amphenol Pcd Terminal Junction Splices

| Circuit Diagram | APCD P/N | Part | Part P/N | Quantity |
|-----------------|-----------|-----------|---------------------|----------|
| | TJSE20501 | Inductor | 1 100 μ H | 1 |
| | TJSE20503 | Fuse | 5 AMP 125V | 1 |
| | TJSE20505 | Resistor | RW81 38 Ω 1W | 1 |
| | TJSE20506 | Resistor | 120 Ω 1/4W | 2 |
| | TJSE20509 | Diode | 5 Amp | 2 |
| | TJSE20510 | Diode | 1 Amp 125V | 1 |
| | TJSE20513 | Capacitor | 620pF | 1 |
| | TJSE20520 | Capacitor | 390pF | 5 |
| | TJSE20523 | Resistor | 15K Ω 1/4W | 1 |
| | TJSE20525 | Resistor | 10K Ω 1/4W | 1 |
| | TJSE20526 | Resistor | 910 Ω 1/4W | 1 |
| | TJSE20553 | Resistor | 1K Ω 1/2W | 1 |
| | TJSE20554 | Resistor | 18K Ω 1/2W | 2 |
| | TJSE20555 | Resistor | 18K Ω 1/2W | 1 |

| Circuit Diagram | APCD P/N | Part | Part P/N | Quantity |
|-----------------|-----------|----------|-----------------------|----------|
| | TJSE20599 | Diode | JANTX1N5554 | 1 |
| | TJSE20602 | Diode | JANTX1N5618 | 2 |
| | TJSE20703 | Diode | 1N5819 | 2 |
| | TJSE20705 | Diode | JANTX1N5622 | 1 |
| | TJSE20706 | Diode | JANTX1N5622 | 2 |
| | TJSE20710 | Diode | 1N5622 | 1 |
| | TJSE20711 | Diode | 1N4006 | 2 |
| | TJSE22503 | Fuse | 5 AMP 125V | 1 |
| | TJSE22514 | Resistor | 10K Ω , 1/4 W | 1 |
| | TJSE22517 | Resistor | 120 Ω , 1 W | 1 |
| | TJSE22523 | Resistor | 75K Ω , 1/2 W | 2 |
| | TJSE22707 | Diode | JANTX1N5622 | 2 |
| | TJSE20599 | Diode | 1N5622 | 1 |
| | TJSE20599 | Resistor | 78.7 Ω , 1/4 W | 2 |

Terminal Junction Modules

M81714/5, /10, /16 Series I

Terminal Junction Module Mounting Tracks



Operating Range

Temperature:
-65° to 200°C

Corrosion:

No Exposure of Base Metal
After 48 Hours of Salt Spray

Magnetic Permeability:
2.0 MU Max.

Vibration and Shock:

Per MIL-T-81714 Paragraph
3.5.5 and 3.5.8

Materials

Rail:

Aluminum Alloy, Black Anodized
Finish per MIL-A-8625

Locking Clamp Screw:

Corrosion Resistant, Passivated,
Self Locking

Product Description

Amphenol Pcd offers feedback and feedthru mounting tracks, as well as a light weight feedback type with weight reduction cutouts per MIL-T-81714/16 for weight critical applications.

One track holds all module sizes. With size 22,20,16 modules requiring one mounting space and size 12 requiring three.

Each track unit consists of an aluminum alloy track and MIL-T-81714/16 anodized black locking clamp. The stainless steel clamp screw is self locking to meet vibration, shock and temperature variation requirements.

Feedback Track Dimensions



Feedback Mounting Tracks

| Standard | | Lightweight | | Dimensions | | |
|--------------|-----------|--------------|-----------|----------------|------|------|
| Military P/N | APCD P/N | Military P/N | APCD P/N | Mounting Pos.* | A | B |
| M81714/5-1 | TJT701010 | M81714/16-1 | TJT703010 | 10 | 5.29 | 4.79 |
| | TJT701002 | | TJT703002 | 2 | 2.17 | 1.67 |
| M81714/5-2 | TJT701003 | M81714/16-2 | TJT703003 | 3 | 2.56 | 2.06 |
| M81714/5-3 | TJT701004 | M81714/16-3 | TJT703004 | 4 | 2.95 | 2.45 |
| M81714/5-4 | TJT701005 | M81714/16-4 | TJT703005 | 5 | 3.34 | 2.84 |
| M81714/5-5 | TJT701006 | M81714/16-5 | TJT703006 | 6 | 3.73 | 3.23 |
| M81714/5-6 | TJT701007 | M81714/16-6 | TJT703007 | 7 | 4.12 | 3.62 |
| M81714/5-7 | TJT701008 | M81714/16-7 | TJT703008 | 8 | 4.51 | 4.01 |
| M81714/5-8 | TJT701009 | M81714/16-8 | TJT703009 | 9 | 4.90 | 4.40 |
| M81714/5-9 | TJT701011 | M81714/16-9 | TJT703011 | 11 | 5.68 | 5.18 |
| M81714/5-10 | TJT701012 | M81714/16-10 | TJT703012 | 12 | 6.07 | 5.57 |
| M81714/5-11 | TJT701013 | M81714/16-11 | TJT703013 | 13 | 6.46 | 5.96 |
| M81714/5-12 | TJT701014 | M81714/16-12 | TJT703014 | 14 | 6.85 | 6.35 |
| M81714/5-13 | TJT701015 | M81714/16-13 | TJT703015 | 15 | 7.24 | 6.74 |
| | TJT701016 | | TJT703016 | 16 | 7.63 | 7.13 |
| | TJT701017 | | TJT703017 | 17 | 8.02 | 7.52 |
| | TJT701018 | | TJT703018 | 18 | 8.41 | 7.91 |
| | TJT701019 | | TJT703019 | 19 | 8.80 | 8.30 |
| | TJT701020 | | TJT703020 | 20 | 9.19 | 8.69 |

*Divide by 3 for Size 12 Module Mounting

Feedthru Track Dimensions



Feedthru Mounting Tracks

| Standard | | Dimensions | | |
|--------------|-----------|----------------|------|------|
| Military P/N | APCD P/N | Mounting Pos.* | A" | B" |
| M81714/10-1 | TJT702010 | 10 | 5.55 | 5.05 |
| | TJT702002 | 2 | 2.43 | 1.91 |
| M81714/10-2 | TJT702003 | 3 | 2.82 | 2.32 |
| M81714/10-3 | TJT702004 | 4 | 3.21 | 2.71 |
| M81714/10-4 | TJT702005 | 5 | 3.60 | 3.10 |
| M81714/10-5 | TJT702006 | 6 | 3.90 | 3.49 |
| M81714/10-6 | TJT702007 | 7 | 4.38 | 3.88 |
| M81714/10-7 | TJT702008 | 8 | 4.77 | 4.27 |
| M81714/10-8 | TJT702009 | 9 | 5.16 | 4.66 |

*Divide by 3 for Size 12 Module Mounting



Компания «ЭлектроПласт» предлагает заключение долгосрочных отношений при поставках импортных электронных компонентов на взаимовыгодных условиях!

Наши преимущества:

- Оперативные поставки широкого спектра электронных компонентов отечественного и импортного производства напрямую от производителей и с крупнейших мировых складов;
- Поставка более 17-ти миллионов наименований электронных компонентов;
- Поставка сложных, дефицитных, либо снятых с производства позиций;
- Оперативные сроки поставки под заказ (от 5 рабочих дней);
- Экспресс доставка в любую точку России;
- Техническая поддержка проекта, помощь в подборе аналогов, поставка прототипов;
- Система менеджмента качества сертифицирована по Международному стандарту ISO 9001;
- Лицензия ФСБ на осуществление работ с использованием сведений, составляющих государственную тайну;
- Поставка специализированных компонентов (Xilinx, Altera, Analog Devices, Intersil, Interpoint, Microsemi, Aeroflex, Peregrine, Syfer, Eurofarad, Texas Instrument, Miteq, Cobham, E2V, MA-COM, Hittite, Mini-Circuits, General Dynamics и др.);

Помимо этого, одним из направлений компании «ЭлектроПласт» является направление «Источники питания». Мы предлагаем Вам помощь Конструкторского отдела:

- Подбор оптимального решения, техническое обоснование при выборе компонента;
- Подбор аналогов;
- Консультации по применению компонента;
- Поставка образцов и прототипов;
- Техническая поддержка проекта;
- Защита от снятия компонента с производства.



Как с нами связаться

Телефон: 8 (812) 309 58 32 (многоканальный)

Факс: 8 (812) 320-02-42

Электронная почта: org@eplast1.ru

Адрес: 198099, г. Санкт-Петербург, ул. Калинина, дом 2, корпус 4, литера А.