

Terminal Junction Systems

MIL-T-81714 Series I Class D



MIL-T-81714 Series I Junction Modules

QPL-approved MIL-T-81714 modules and MIL-C-39029/1 contacts are available in four standard sizes accommodating 12-26 AWG wires in both feedback and feedthru types with full a selection of bussing arrangements. The complete MIL-T-81714 Series I Terminal Junction System includes the following products.



Feedback Modules
Feedthru Modules



Electronic Modules



Ground Modules



Single In-Line Splices
Dual In-Line Splices
Electronic Splices



Mounting Tracks

Key Features and Benefits

Integral Socket/Bus Bar

The patented integral socket/bus bar assembly provides superior electrical characteristics and assures mechanical integrity over a long product life. This unique design totally eliminates all solder of welded joints which could cause variation in electrical and/or mechanical performance

Integral Contacts

Integral female contacts and bus bar have no mechanical functions- only the electrical conductivity function and are highly conductive alloy for optimum electrical performance.

Split Socket Design

Split Socket Design, conforming to the mating pin diameter, provides peripheral surface wipe and contact, while utilizing the maximum mating surfaces of pin and socket.

High Density Modules

A recently introduced series of high density modules which conform to all dimensional and performance requirements of MIL-T-81714/17 is now available from Amphenol Pcd. The high density modules accept 21 size 22 contacts in a compact 3x7 configuration, with a wide variety of bus arrangements. The construction features one-piece screw machine contacts with a split socket design for maximum performance. Contacts are securely packaged within a polyetherimide housing.

Class D Modules System

Amphenol Pcd was the first supplier to qualify module and track systems to high performance MIL-T-81714 Series I Class D requirements. Class D systems combine the maximum high temperature and high fluid resistance performance parameters previously divided among three module classes A,B, and C.

Electronic Splices

TJSE electronic modules can be supplied with a wide variety of diodes, resistors, capacitors, and fuses within the splice itself. TJSE electronic splices meet the electrical parameters of MIL-81714/24 and allow customers to incorporate system modifications into a wire bundle, avoiding changes in panles modules.



Military Qualified, QPL-Listed

MIL-T-81714 Series I, Class D

Class D Feedback Modules

Military P/N	Amphenol Pcd P/N	Page
M81714/1-DA1	TJM122701	36
M81714/1-DB1	TJM122702	36
M81714/1-DB2	TJM122703	36
M81714/1-DB3	TJM122704	36
M81714/1-DC1	TJM122705	36
M81714/1-DC2	TJM122706	36
M81714/1-DC3	TJM122710	36
M81714/1-DC4	TJM122712	36
M81714/1-DD1	TJM122707	36
M81714/1-DD2	TJM122711	36
M81714/1-DE1	TJM122708	36
M81714/2-DA1	TJM120701	37
M81714/2-DB1	TJM120702	37
M81714/2-DB2	TJM120703	37
M81714/2-DB3	TJM120704	37
M81714/2-DC1	TJM120705	37
M81714/2-DC2	TJM120706	37
M81714/2-DC3	TJM120710	37
M81714/2-DC4	TJM120712	37
M81714/2-DD1	TJM120707	37
M81714/2-DD2	TJM120711	37
M81714/2-DE1	TJM120708	37
M81714/3-DA1	TJM116701	38
M81714/3-DB1	TJM116702	38
M81714/3-DB2	TJM116703	38
M81714/3-DC1	TJM116705	38
M81714/3-DC2	TJM116706	38
M81714/3-DD1	TJM116707	38
M81714/4-DA1	TJM112701	39
M81714/4-DB1	TJM112702	39
M81714/4-DB2	TJM112703	39
M81714/4-DC1	TJM112705	39
M81714/4-DC2	TJM112706	39
M81714/4-DD1	TJM112707	39
M81714/17-D30	TJHD22700	40
M81714/17-D31	TJHD22701	40
M81714/17-D32	TJHD22702	40
M81714/17-D33	TJHD22703	40
M81714/17-D34	TJHD22704	40
M81714/17-D35	TJHD22705	40
M81714/17-D36	TJHD22706	40
M81714/17-D37	TJHD22707	40
M81714/17-D38	TJHD22708	40
M81714/17-D39	TJHD22709	40
M81714/17-D40	TJHD22710	40
M81714/17-D42	TJHD22712	40
M81714/17-D43	TJHD22713	40
M81714/17-D44	TJHD22714	40
M81714/17-D45	TJHD22715	40

Class D Feedthru Modules

Military P/N	Amphenol Pcd P/N	Page
M81714/6-DA1	TJM222701	36
M81714/6-DB1	TJM222702	36
M81714/6-DB2	TJM222703	36
M81714/6-DB3	TJM222704	36
M81714/6-DC1	TJM222705	36
M81714/6-DC2	TJM222706	36
M81714/6-DD1	TJM222707	36
M81714/6-DE1	TJM222708	36
M81714/6-DJ1	TJM222709	36
M81714/7-DA1	TJM220701	37
M81714/7-DB1	TJM220702	37
M81714/7-DB2	TJM220703	37
M81714/7-DB3	TJM220704	37
M81714/7-DC1	TJM220705	37
M81714/7-DC2	TJM220706	37
M81714/7-DD1	TJM220707	37
M81714/7-DE1	TJM220708	37
M81714/7-DJ1	TJM220709	37
M81714/8-DA1	TJM216701	38
M81714/8-DB1	TJM216702	38
M81714/8-DB2	TJM216703	38
M81714/8-DC1	TJM216705	38
M81714/8-DC2	TJM216706	38
M81714/8-DD1	TJM216707	38
M81714/8-DG1	TJM216708	38
M81714/8-DH1	TJM216709	38
M81714/9-DA1	TJM212701	39
M81714/9-DB2	TJM212702	39
M81714/9-DB3	TJM212703	39
M81714/9-DC1	TJM212705	39
M81714/9-DC2	TJM212706	39
M81714/9-DD1	TJM212707	39
M81714/9-DH1	TJM212709	39

Terminal Junction Modules

M81714/1, /6 Series I Size 22 Class D



Operating Range

Temperature:
-65°C to 200°C
Insulation Resistance:
5000 Megaohms @ 25°C
Dielectric Withstanding Voltage:
1500 VRMS at Sea Level
200 VRMS at 100,000 ft.
Current Rating
5 Amps
Vibration & Shock:
MIL-T-81714 Paragraph
3.5.5 and 3.5.8

Materials

Module Body:
Polyetherimide per ASTM-D5205
Grommet:
Silicone Blend Elastomer per A-A-59588
Contact Retainers:
Stainless Steel
Internal Socket Contacts:
Copper Alloy, Hard Gold Plated in
Accordance with MIL-G-45204
Accepts Multiple Wire Sizes:
Size 22, 24, 26 AWG

Amphenol Pcd Terminal Junction Modules

Bussing Configurations	Feedback		Feedthru		Contact		
	Military P/N	APCD P/N	Military P/N	APCD P/N	QTY*	Size ¹	P/N M39029
	M81714/1-DA1	TJM122701	M81714/6-DA1	TJM222701	10	16/22	/1-100
	M81714/1-DB1	TJM122702	M81714/6-DB1	TJM222702	10	16/22	/1-100
	M81714/1-DB2	TJM122703	M81714/6-DB2	TJM222703	10	16/22	/1-100
	M81714/1-DB3	TJM122704	M81714/6-DB3	TJM222704	10	16/22	/1-100
	M81714/1-DC1	TJM122705	M81714/6-DC1	TJM222705	10	16/22	/1-100
	M81714/1-DC2	TJM122706	M81714/6-DC2	TJM222706	10	16/22	/1-100
	M81714/1-DC3	TJM122710			10	16/22	/1-100
	M81714/1-DC4	TJM122712			10	16/22	/1-100
	M81714/1-DD1	TJM122707	M81714/6-DD1	TJM222707	10	16/22	/1-100
	M81714/1-DD2	TJM122711			10	16/22	/1-100
	M81714/1-DE1	TJM122708	M81714/6-DE1	TJM222708	10	16/22	/1-100
			M81714/6-DJ1	TJM222709	10	16/22	/1-100

* Contact quantity for feedthru is double feedback. Quantity figure denotes number of contacts accommodated by module. Modules are supplied with one additional spare contact and sealing plug.
¹ Mating Pin / Wire Barrel

Terminal Junction Module Dimensions

Feedback Dimensions

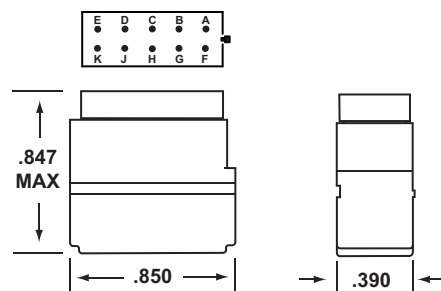

Feedthru Dimensions

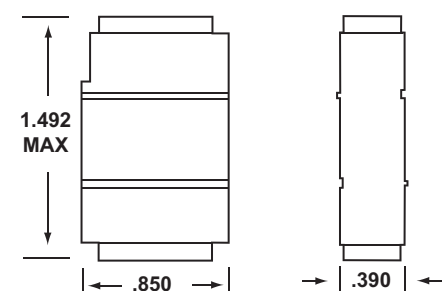

M81714/2, /7

Series I Size 20 Class D

Terminal Junction Modules

Operating Range

Temperature:

-65°C to 200°C

Insulation Resistance:

5000 Megaohms @ 25°C

Dielectric Withstanding Voltage:

1500 VRMS at Sea Level

200 VRMS at 100,000 ft.

Current Rating

7.5 Amps

Vibration & Shock:

MIL-T-81714 Paragraph

3.5.5 and 3.5.8

Materials

Module Body:

Polyetherimide per ASTM-D5205

Grommet:

Silicone Blend Elastomer per A-A-59588

Contact Retainers:

Stainless steel

Socket Contacts:

Copper Alloy, Hard Gold Plated in

Accordance with MIL-G-45204

Accepts Multiple Wire Sizes:

Size 20, 22, 24 AWG



Amphenol Pcd Terminal Junction Modules

Bussing Configurations	Feedback		Feedthru		Contact		
	Military P/N	APCD P/N	Military P/N	APCD P/N	QTY*	Size ¹	P/N M39029
	M81714/2-DA1	TJM120701	M81714/7-DA1	TJM220701	10	16/20	/1-101
	M81714/2-DB1	TJM120702	M81714/7-DB1	TJM220702	10	16/20	/1-101
	M81714/2-DB2	TJM120703	M81714/7-DB2	TJM220703	10	16/20	/1-101
	M81714/2-DB3	TJM120704	M81714/7-DB3	TJM220704	10	16/20	/1-101
	M81714/2-DC1	TJM120705	M81714/7-DC1	TJM220705	10	16/20	/1-101
	M81714/2-DC2	TJM120706	M81714/7-DC2	TJM220706	10	16/20	/1-101
	M81714/2-DC3	TJM120710			10	16/20	/1-101
	M81714/2-DC4	TJM120712			10	16/20	/1-101
	M81714/2-DD1	TJM120707	M81714/7-DD1	TJM220707	10	16/20	/1-101
	M81714/2-DD2	TJM120711			10	16/20	/1-101
	M81714/2-DE1	TJM120708	M81714/7-DE1	TJM220708	10	16/20	/1-101
			M81714/7-DJ1	TJM220709	10	16/20	/1-101

* Contact quantity for feedthru is double feedback. Quantity figure denotes number of contacts accommodated by module. Modules are supplied with one additional spare contact and sealing plug.
¹ Mating Pin / Wire Barrel

Terminal Junction Module Dimensions

Feedback Dimensions



Feedthru Dimensions

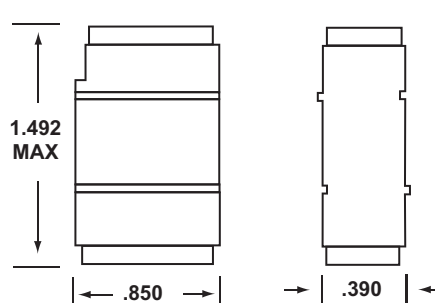

Amphenol Pcd

Terminal Junction Modules

M81714/3, /8 Series I Size 16 Class D



Operating Range

Temperature:
-65°C to 200°C

Insulation Resistance:
5000 Megaohms @ 25°C

Dielectric Withstanding Voltage:
1500 VRMS at Sea Level
200 VRMS at 100,000 ft.

Current Rating
13 Amps

Vibration & Shock:
MIL-T-81714 Paragraph
3.5.5 and 3.5.8

Materials

Module Body:
Polyetherimide per ASTM-D5205

Grommet:
Silicone Blend Elastomer per A-A-59588

Contact Retainers:
Stainless Steel

Socket Contacts:
Copper Alloy, Hard Gold Plated in
Accordance with MIL-G-45204

Accepts Multiple Wire Sizes:
Size 16, 18, 20 AWG

Amphenol Pcd Terminal Junction Modules

Bussing Configurations	Feedback		Feedthru		Contact		
	Military P/N	APCD P/N	Military P/N	APCD P/N	QTY*	Size ¹	P/N M39029
	M81714/3-DA1	TJM116701	M81714/8-DA1	TJM216701	8	14/16	/1-102
	M81714/3-DB1	TJM116702	M81714/8-DB1	TJM216702	8	14/16	/1-102
	M81714/3-DB2	TJM116703	M81714/8-DB2	TJM216703	8	14/16	/1-102
	M81714/3-DC1	TJM116705	M81714/8-DC1	TJM216705	8	14/16	/1-102
	M81714/3-DC2	TJM116706	M81714/8-DC2	TJM216706	8	14/16	/1-102
	M81714/3-DD1	TJM116707	M81714/8-DD1	TJM216707	8	14/16	/1-102
			M81714/8-DG1	TJM216708	8	14/16	/1-102
			M81714/8-DH1	TJM216709	8	14/16	/1-102

* Contact quantity for feedthru is double feedback. Quantity figure denotes number of contacts accommodated by module. Modules are supplied with one additional spare contact and sealing plug.
¹ Mating Pin / Wire Barrel

Terminal Junction Module Dimensions



Feedback Dimensions



Feedthru Dimensions

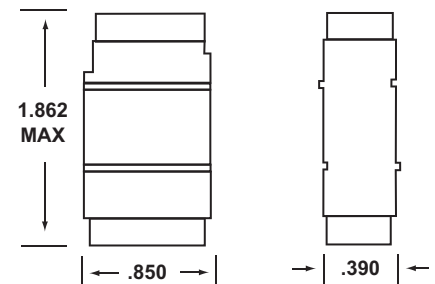

M81714/4, /9

Series I Size 12 Class D

Terminal Junction Modules

Operating Range

Temperature:

-65°C to 200°C

Insulation Resistance:

5000 Megaohms @ 25°C

Dielectric Withstanding Voltage:

1500 VRMS at Sea Level

200 VRMS at 100,000 ft.

Current Rating

23 Amps

Vibration & Shock:

MIL-T-81714 Paragraph

3.5.5 and 3.5.8

Materials

Module Body:

Polyetherimide per ASTM-D5205

Grommet:

Silicone Blend Elastomer per A-A-59588

Contact Retainers:

Stainless steel

Internal Socket Contacts:

Copper Alloy, Hard Gold Plated in

Accordance with MIL-G-45204

Accepts Multiple Wire Sizes:

Size 12, 14 AWG



Terminal Junction Modules

Bussing Configurations	Feedback		Feedthru		Contact		
	Military P/N	APCD P/N	Military P/N	APCD P/N	QTY*	Size ¹	P/N M39029
	M81714/4-DA1	TJM112701	M81714/9-DA1	TJM212701	8	12/12	/1-103
	M81714/4-DB1	TJM112702	M81714/9-DB1	TJM212702	8	12/12	/1-103
	M81714/4-DB2	TJM112703	M81714/9-DB2	TJM212703	8	12/12	/1-103
	M81714/4-DC1	TJM112705	M/81714/9-DC1	TJM212705	8	12/12	/1-103
	M81714/4-DC2	TJM112706	M81714/9-DC2	TJM212706	8	12/12	/1-103
	M81714/4-DD1	TJM112707	M81714/9-DD1	TJM212707	8	12/12	/1-103
			M81714/9-DH1	TJM212709	8	12/12	/1-103

* Contact quantity for feedthru is double feedback. Quantity figure denotes number of contacts accommodated by module. Modules are supplied with one additional spare contact and sealing plug.

¹ Mating Pin / Wire Barrel

Terminal Junction Module Dimensions

Feedback Dimensions

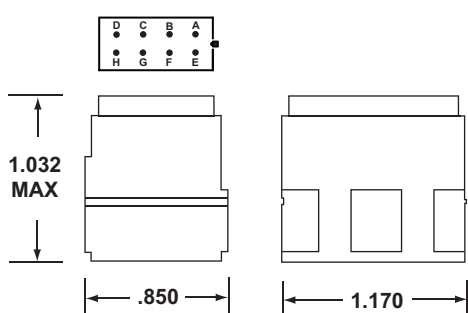

Feedthru Dimensions

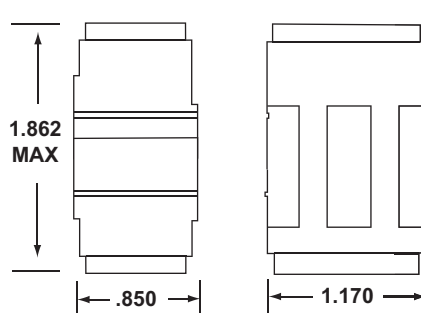

Amphenol Pcd

M81714/17 High Density Modules

Series I Size 22D Class D

Terminal Junction Modules



Operating Range

Temperature:
-65°C to 200°C

Insulation Resistance:
5000 Megaohms @ 25°C

Dielectric Withstanding Voltage:
1000 VRMS at Sea Level
200 VRMS at 110,000 ft.

Current Rating
5 Amps

Vibration & Shock:
MIL-T-81714 Paragraph
3.5.5 and 3.5.8

Materials

Module Body:
Polyetherimide per ASTM-D5205

Grommet:
Silicone Blend Elastomer per A-A-59588

Contact Retainers:
Stainless Steel

Internal Socket Contacts:
Copper Alloy, Hard Gold Plated in
Accordance with MIL-G-45204

Accepts Multiple Wire Sizes:
Size 22, 26 AWG

Amphenol Pcd Terminal Junction Modules

Bussing Configurations	Feedback	
	Military P/N	APCD P/N
	M81714/17-D30	TJHD22700
	M81714/17-D31	TJHD22701
	M81714/17-D32	TJHD22702
	M81714/17-D33	TJHD22703
	M81714/17-D34	TJHD22704
	M81714/17-D35	TJHD22705
	M81714/17-D36	TJHD22706
	M81714/17-D37	TJHD22707

Bussing Configurations	Feedback	
	Military P/N	APCD P/N
	M81714/17-D38	TJHD22708
	M81714/17-D39	TJHD22709
	M81714/17-D40	TJHD22710
	M81714/17-D42	TJHD22712
	M81714/17-D43	TJHD22713
	M81714/17-D44	TJHD22714
	M81714/17-D45	TJHD22715

Contacts Supplied: M39029/1-507 Qty 22

Terminal Junction Module Dimensions

Feedback Dimensions

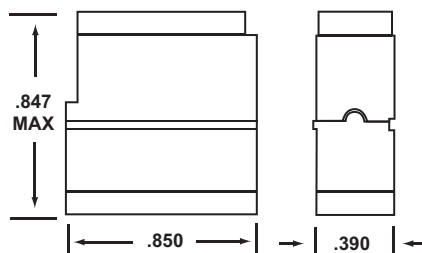

Bussing Configuration

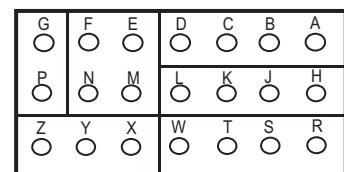

Contacts Supplied: M39029/1-507
Quantity Supplied: 22



M81714/27 Ground Stud Modules

Series II Size 22, 20, 16, 12, Class D

Operating Range

Temperature:

-65°C to 200°C

Current Rating

5 Amps (Size 22)

7.5 Amps (Size 20)

13 Amps (Size 16)

23 Amps (Size 12)

Vibration & Shock:

MIL-T-81714 Paragraph

3.5.5 and 3.5.8

Materials

Module Body:

Polyetherimide per ASTM-D5205

Grommet:

Silicone Blend Elastomer per A-A-59588

Mounting Stud:

Copper Alloy, Gold Plated per SAE-AMS-2422.

Contact Retainers:

Stainless Steel

Internal Socket Contacts:

Copper Alloy, Hard Gold Plated in Accordance with MIL-G-45204

Terminal Junction Modules



Terminal Grounding Modules Part Numbers

Part Numbers		Contact		
Military Equivalent P/N	APCD P/N	QTY*	Size ¹	P/N M39029
M81714/27-22	TJG122701	10	16/22	/1-100
M81714/27-20	TJG120701	10	16/20	/1-101
M81714/27-16	TJG116701	8	14/16	/1-102
M81714/27-12	TJG112701	8	12/12	/1-103

* Mating End/ Wire Barrel

¹ Quantity figure denotes number of contacts accommodated by module. Modules are supplied with two additional spare contacts and sealing plugs

Product Description

Multi-contact grounding/bus connection modules are provided with an integral threaded grounding stud. The stud is electrically and mechanically common to all internal contacts of the module.

Electrical connection and mechanical mounting are achieved through a single #10-32 stud. The modules are dimensional identical to the equivalent MIL-T-81714/27 grounding stud modules.

Direct mounting to a ground plane or ground wire with the terminal lug creates a convenient multi-wire sealed grounding device.

Direct attachment to a bus bar transforms the device into a bus connection module for multi-contact power distribution, sensing or metering.

All modules are furnished with complete mounting hardware.

Terminal Junction Module Dimensions

Top View



Side View

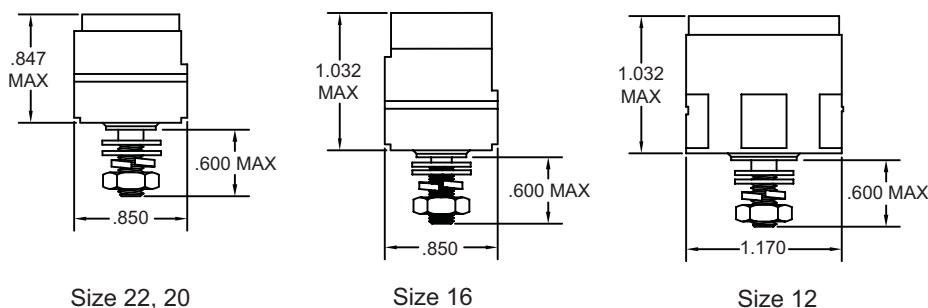

Amphenol Pcd

Electronic Terminal Junction Modules

MIL-T-81714/26 Compatible Class D

Terminal Junction Modules



Operating Range

Temperature:
-65°C to 200°C*

Insulation Resistance:
5000 Megaohms Min. @ 25°C*

Dielectric Withstanding Voltage:
1500 VRMS at Sea Level
200 VRMS at 100,000 ft.*

Vibration & Shock:
Per MIL-T-81714
Paragraph 3.5.5 & 3.5.9*

Current Rating:
7.5 amps*

Materials

Module Body:
Polyetherimide per ASTM-D-5205

Grommet:
Silicone Rubber per A-A-59588

Contact Retainers:
Stainless Steel

Internal Contact:
Copper Alloy, Gold Finish

* May vary due to internal electronic component

Amphenol Pcd Terminal Junction Module

Product Description

Electronic Terminal Junction modules meet all dimensional and performance requirements of M81714/26 and are specifically developed for electronic component packaging. Available for size 20 and 22 contacts, these modules function as highly efficient and reliable Electronic component packages. They improve system efficiency and density by permitting various electronic components such as diodes, resistors, fuses, and capacitors, which usually take up valuable space elsewhere in the system, to be securely packaged within the module housing.

Amphenol Pcd electronic modules offer significant design, material and construction improvements over competitive modules. Hand soldering operations have been completely eliminated. Electronic components are encapsulated in a semi-rigid elastomer that provides electrical spacing and insulation as well as shock and vibration protection.

Typical commercially available diode configurations are indicated on this page. A broad variety of additional configurations are available, and modules can be customized to meet specific customer designs. Please contact Amphenol Pcd to review requirements and discuss available options.

Circuit Diagram	APCD P/N	Diode P/N	Quantity
	TJE120810	JANTX1N5552	5
	TJE120811	JANTX1N5552	4
	TJE120815	1N4005	2
	TJE120998	BYW56	2
	TJE120999	BYW56	2

Terminal Junction Module Dimensions

Top View

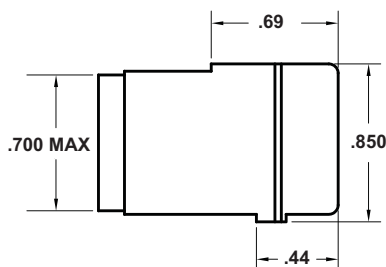

Side View

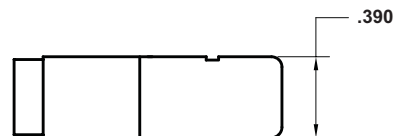

Electronic Terminal Junction Modules

MIL-T-81714/26 Compatible Class D

Terminal Junction Modules

Amphenol Pcd's Electronic Terminal Junction Modules are available with a variety of components and in a wide range of configurations. Components available include but are not limited to diodes, resistors, fuses, capacitors, thyristors, and inductors, and are also available with multiple components within one module. The following are currently available Electronic Terminal Junction Modules, although there are new configurations produced regularly and customized components are also available.



Amphenol Pcd Electronic Terminal Junction Modules

Circuit Diagram	APCD P/N	Part	Part P/N	Quantity
	TJE120514	Capacitor	620pF	1
	TJE120816	Diode	IN4003	3
	TJE120817	Diode	IN4003	2
	TJE120818	Diode	IN4003	3
	TJE120819	Diode	IN4003	3
	TJE120820	Diode	IN4003	3
	TJE120822	Diode	IN4007	5
	TJE120824	Diode	JANTX1N5618	5
	TJE120826	Diode	IN4006	2
	TJE120827	Diode	JANTX1N5552	2
	TJE120828	Diode	JANTX1N5618	2
	TJE120829	Diode	1N5618	2
	TJE120831	Diode	1N5618	2
	TJE120833	Diode	1N5418	2

Circuit Diagram	APCD P/N	Part	Part P/N	Quantity
	TJE120900	Resistor	10 K Ω , 1/8 W	5
	TJE120902	Resistor	150K Ω , 1/8 W	5
	TJE120903	Resistor	33 Ω , 1/4 W	2
	TJE120904	Resistor	1K Ω , 1/8 W	2
	TJE120905	Resistor	1K Ω , 1/2 W	2
	TJE120906	Resistor	150 Ω , 1/2 W	1
	TJE120907	Resistor	180 Ω , 1/2 W	1
	TJE120908	Resistor	Various Ω , 1/2 W	5
	TJE120920	Resistor	54K, 6K Ω , 1/2W	2
	TJE120921	Resistor	500K Ω , 1 W	5
	TJE120922	Resistor	Various Ω , 1/2 W	5
	TJE120924	Resistor	1K Ω , 1/4 W	4
	TJE120927	Fuse	1 AMP	5
	TJE120928	Resistor	1.3K Ω , 1/2 W	5

Terminal Junction Splices

Single/ Dual/ Diode M81714/11, /12,/24 Series I

Terminal Junction Splices



Operating Range

Temperature:
-65°C to 200°C

Insulation Resistance:
5000 Megaohms Min.

Dielectric Withstanding Voltage:
1500 VRMS at Sea Level
200 VRMS at 100,000 ft.

Vibration & Shock:
Per AS-81714
Paragraph 3.5.5 & 3.5.8

Materials

Insulator Body:
Polyetherimide per ASTM-D-5205

Grommet:
Silicone Rubber per A-A-59588

Internal Contact:
Copper Alloy, Gold Finish
Accordance with MIL-G-45204

Product Description

Single and Dual Splices and Electronic Splices are designed to provide a quick and efficient solution to customer wiring requirements.

Single and Dual Wire Splices meet MIL-T-81714/11 & 12 requirements and are highly resistant to temperature and fluids.

TJSE electronic modules can be supplied with a wide variety of diodes, resistors, capacitors, and fuses within the splice itself. TJSE electronic splices meet the electronic parameters of MIL-81714/24 and allow customers to incorporate system modifications into a wire bundle, avoiding changes in panels or boards.

Typical examples are represented to the right, but customer specific designs are welcomed, and an extensive list of existing splices are available on the next page.

Single Wire Splices

	Contacts		Part Numbers		
	Military P/N	APCD P/N	Quantity	Size*	Part No.
	M81714/11-22D	TJS322700	2	16/22	M39029/1-100
	M81714/11-20D	TJS320700	2	16/20	M39029/1-101
	M81714/11-12D	TJS316700	2	14/16	M39029/1-102
	M81714/11-16D	TJS312700	2	12/12	M39029/1-103

Dual Wire Splices

Bussing Type	Part Numbers		Contacts		Diameter	
	MIL P/N 81714	APCD P/N	Quantity	Size* P/N M39029	A	B
	/12-22D-1	TJS322701	4	16/22 /1-100	.400	.275
	/12-20D-1	TJS320701	4	16/20 /1-101	.400	.275
	/12-16D-1	TJS316701	4	14/16 /1-102	.500	.300
	/12-22D-2	TJS322702	4	16/22 /1-100	.400	.275
	/12-20D-2	TJS320702	4	16/20 /1-101	.400	.275
	/12-16D-2	TJS316702	4	14/16 /1-102	.500	.300

Electronic Splices

Circuit Type	Part Numbers		Diode		Contacts	
	APCD P/N	Diode P/N	Quantity	Size*	Quantity P/N M39029	
	TJSE22707	JANTX1N5622	1	16/22	4	1-100
	TJSE20705	JANTX1N5622	1	16/20	4	1-101
	TJSE22709	JANTX1N5622	2	16/22	4	1-100
	TJSE20705	JANTX1N5622	2	16/20	4	1-101

*Mating Pin Wire Barrel

Relay Socket Dimensions

Single Splice

1.552 Max
Diameter .250 ± .025

Double Splice

Dimension C
Size 20/22 1.552 Max
Size 16 1.922 Max

Electronic Splice

2.000 Max
Diameter .275 Max

Electronic Terminal Junction Splices

MIL-T-81714/24 Compatible Class D

Terminal Junction Modules

Amphenol Pcd's Electronic Terminal Junction Splices are available with a variety of components and in a wide range of configurations. Components available include but are not limited to diodes, resistors, fuses, capacitors, thyristors, and inductors, and are also available with multiple components within one module. The following are currently available Electronic Terminal Junction Splices, although there are new configurations produced regularly and customized components are also available.



Amphenol Pcd Terminal Junction Splices

Circuit Diagram	APCD P/N	Part	Part P/N	Quantity
	TJSE20501	Inductor	1 100 μ H	1
	TJSE20503	Fuse	5 AMP 125V	1
	TJSE20505	Resistor	RW81 38 Ω 1W	1
	TJSE20506	Resistor	120 Ω 1/4W	2
	TJSE20509	Diode	5 Amp	2
	TJSE20510	Diode	1 Amp 125V	1
	TJSE20513	Capacitor	620pF	1
	TJSE20520	Capacitor	390pF	5
	TJSE20523	Resistor	15K Ω 1/4W	1
	TJSE20525	Resistor	10K Ω 1/4W	1
	TJSE20526	Resistor	910 Ω 1/4W	1
	TJSE20553	Resistor	1K Ω 1/2W	1
	TJSE20554	Resistor	18K Ω 1/2W	2
	TJSE20555	Resistor	18K Ω 1/2W	1

Circuit Diagram	APCD P/N	Part	Part P/N	Quantity
	TJSE20599	Diode	JANTX1N5554	1
	TJSE20602	Diode	JANTX1N5618	2
	TJSE20703	Diode	1N5819	2
	TJSE20705	Diode	JANTX1N5622	1
	TJSE20706	Diode	JANTX1N5622	2
	TJSE20710	Diode	1N5622	1
	TJSE20711	Diode	1N4006	2
	TJSE22503	Fuse	5 AMP 125V	1
	TJSE22514	Resistor	10K Ω , 1/4 W	1
	TJSE22517	Resistor	120 Ω , 1 W	1
	TJSE22523	Resistor	75K Ω , 1/2 W	2
	TJSE22707	Diode	JANTX1N5622	2
	TJSE20599	Diode	1N5622	1
	TJSE20599	Resistor	78.7 Ω , 1/4 W	2

Terminal Junction Modules

M81714/5, /10, /16 Series I

Terminal Junction Module Mounting Tracks



Operating Range

Temperature:
-65° to 200°C

Corrosion:

No Exposure of Base Metal
After 48 Hours of Salt Spray

Magnetic Permeability:
2.0 MU Max.

Vibration and Shock:

Per MIL-T-81714 Paragraph
3.5.5 and 3.5.8

Materials

Rail:

Aluminum Alloy, Black Anodized
Finish per MIL-A-8625

Locking Clamp Screw:

Corrosion Resistant, Passivated,
Self Locking

Product Description

Amphenol Pcd offers feedback and feedthru mounting tracks, as well as a light weight feedback type with weight reduction cutouts per MIL-T-81714/16 for weight critical applications.

One track holds all module sizes. With size 22,20,16 modules requiring one mounting space and size 12 requiring three.

Each track unit consists of an aluminum alloy track and MIL-T-81714/16 anodized black locking clamp. The stainless steel clamp screw is self locking to meet vibration, shock and temperature variation requirements.

Feedback Track Dimensions



Feedback Mounting Tracks

Standard		Lightweight		Dimensions		
Military P/N	APCD P/N	Military P/N	APCD P/N	Mounting Pos.*	A	B
M81714/5-1	TJT701010	M81714/16-1	TJT703010	10	5.29	4.79
	TJT701002		TJT703002	2	2.17	1.67
M81714/5-2	TJT701003	M81714/16-2	TJT703003	3	2.56	2.06
M81714/5-3	TJT701004	M81714/16-3	TJT703004	4	2.95	2.45
M81714/5-4	TJT701005	M81714/16-4	TJT703005	5	3.34	2.84
M81714/5-5	TJT701006	M81714/16-5	TJT703006	6	3.73	3.23
M81714/5-6	TJT701007	M81714/16-6	TJT703007	7	4.12	3.62
M81714/5-7	TJT701008	M81714/16-7	TJT703008	8	4.51	4.01
M81714/5-8	TJT701009	M81714/16-8	TJT703009	9	4.90	4.40
M81714/5-9	TJT701011	M81714/16-9	TJT703011	11	5.68	5.18
M81714/5-10	TJT701012	M81714/16-10	TJT703012	12	6.07	5.57
M81714/5-11	TJT701013	M81714/16-11	TJT703013	13	6.46	5.96
M81714/5-12	TJT701014	M81714/16-12	TJT703014	14	6.85	6.35
M81714/5-13	TJT701015	M81714/16-13	TJT703015	15	7.24	6.74
	TJT701016		TJT703016	16	7.63	7.13
	TJT701017		TJT703017	17	8.02	7.52
	TJT701018		TJT703018	18	8.41	7.91
	TJT701019		TJT703019	19	8.80	8.30
	TJT701020		TJT703020	20	9.19	8.69

*Divide by 3 for Size 12 Module Mounting

Feedthru Track Dimensions



Feedthru Mounting Tracks

Standard		Dimensions		
Military P/N	APCD P/N	Mounting Pos.*	A"	B"
M81714/10-1	TJT702010	10	5.55	5.05
	TJT702002	2	2.43	1.91
M81714/10-2	TJT702003	3	2.82	2.32
M81714/10-3	TJT702004	4	3.21	2.71
M81714/10-4	TJT702005	5	3.60	3.10
M81714/10-5	TJT702006	6	3.90	3.49
M81714/10-6	TJT702007	7	4.38	3.88
M81714/10-7	TJT702008	8	4.77	4.27
M81714/10-8	TJT702009	9	5.16	4.66

*Divide by 3 for Size 12 Module Mounting



Компания «ЭлектроПласт» предлагает заключение долгосрочных отношений при поставках импортных электронных компонентов на взаимовыгодных условиях!

Наши преимущества:

- Оперативные поставки широкого спектра электронных компонентов отечественного и импортного производства напрямую от производителей и с крупнейших мировых складов;
- Поставка более 17-ти миллионов наименований электронных компонентов;
- Поставка сложных, дефицитных, либо снятых с производства позиций;
- Оперативные сроки поставки под заказ (от 5 рабочих дней);
- Экспресс доставка в любую точку России;
- Техническая поддержка проекта, помощь в подборе аналогов, поставка прототипов;
- Система менеджмента качества сертифицирована по Международному стандарту ISO 9001;
- Лицензия ФСБ на осуществление работ с использованием сведений, составляющих государственную тайну;
- Поставка специализированных компонентов (Xilinx, Altera, Analog Devices, Intersil, Interpoint, Microsemi, Aeroflex, Peregrine, Syfer, Eurofarad, Texas Instrument, Miteq, Cobham, E2V, MA-COM, Hittite, Mini-Circuits, General Dynamics и др.);

Помимо этого, одним из направлений компании «ЭлектроПласт» является направление «Источники питания». Мы предлагаем Вам помощь Конструкторского отдела:

- Подбор оптимального решения, техническое обоснование при выборе компонента;
- Подбор аналогов;
- Консультации по применению компонента;
- Поставка образцов и прототипов;
- Техническая поддержка проекта;
- Защита от снятия компонента с производства.



Как с нами связаться

Телефон: 8 (812) 309 58 32 (многоканальный)

Факс: 8 (812) 320-02-42

Электронная почта: org@eplast1.ru

Адрес: 198099, г. Санкт-Петербург, ул. Калинина, дом 2, корпус 4, литера А.