

Transition-mode PFC controller

Features

- Proprietary multiplier design for minimum THD
- Very accurate adjustable output overvoltage protection
- Ultra-low (30 μ A) Start-up current
- Low (2.5mA) quiescent current
- Digital leading-edge blanking on current sense
- Disable function on E/A input
- 1% (@ $T_J = 25\text{ }^\circ\text{C}$) internal reference voltage
- -600/+800mA totem pole gate driver with active pull-down during UVLO and voltage clamp
- DIP-8/SO-8 packages



Applications

PFC pre-regulators for:

- IEC61000-3-2 compliant SMPS (Flat TV, monitors, desktop PC, games)
- HI-END AC-DC adapter/charger up to 400W
- Electronic ballast
- Entry level server & web server

Figure 1. Block diagram

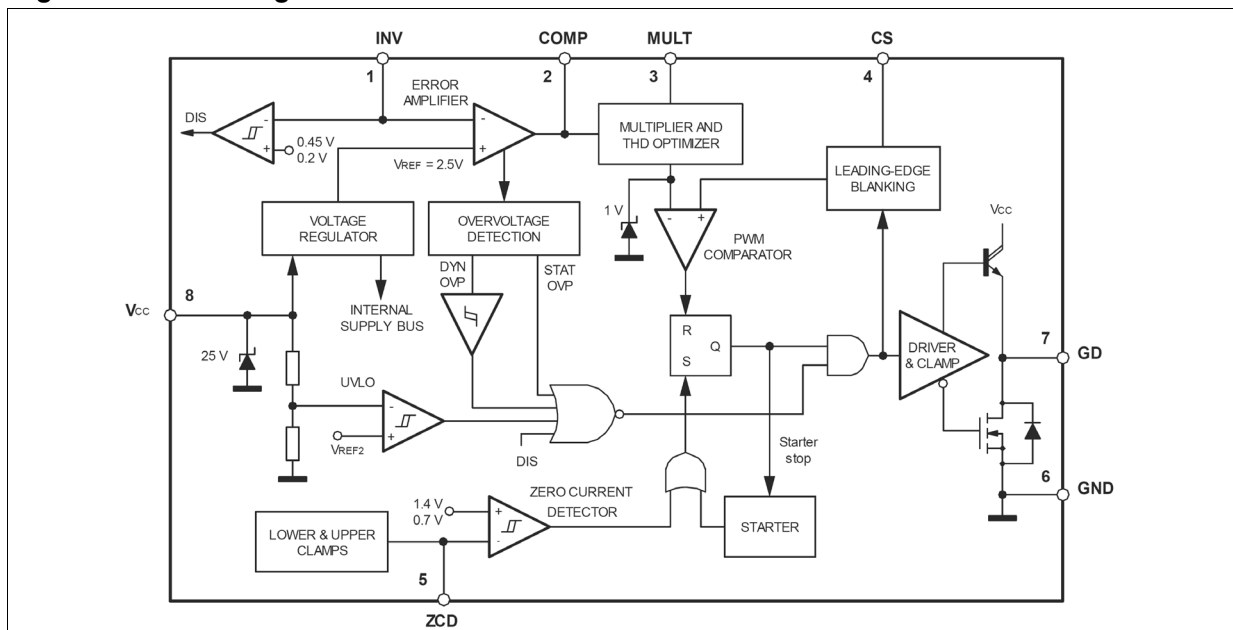

Table 1. Device summary

Order codes	Package	Packaging
L6562AN	DIP-8	Tube
L6562AD	SO-8	Tube
L6562ADTR	SO-8	Tape & Reel

Contents

1	Description	3
2	Pin settings	4
2.1	Pin connection	4
2.2	Pin description	4
3	Maximum ratings	5
4	Thermal data	5
5	Electrical characteristics	6
6	Typical electrical characteristic	9
7	Application information	13
7.1	Overvoltage protection	13
7.2	Disable function	14
7.3	THD optimizer circuit	14
7.4	Operating with no auxiliary winding on the boost inductor	16
7.5	Comparison between the L6562A and the L6562	17
8	Application examples and ideas	18
9	Package mechanical data	22
10	Revision history	25

1 Description

The L6562A is a current-mode PFC controller operating in Transition Mode (TM). Coming with the same pin-out as its predecessors L6561 and L6562, it offers improved performance.

The highly linear multiplier includes a special circuit, able to reduce AC input current distortion, that allows wide-range-mains operation with an extremely low THD, even over a large load range.

The output voltage is controlled by means of a voltage-mode error amplifier and an accurate (1% @ $T_J = 25^\circ\text{C}$) internal voltage reference.

The device features extremely low consumption (60 μA max. before start-up and <5 mA operating) and includes a disable function suitable for IC remote ON/OFF, which makes it easier to comply with energy saving requirements (Blue Angel, EnergyStar, Energy2000, etc.).

An effective two-step OVP enables to safely handle overvoltages either occurring at start-up or resulting from load disconnection.

The totem-pole output stage, capable of 600 mA source and 800 mA sink current, is suitable to drive high current MOSFETs or IGBTs. This, combined with the other features and the possibility to operate with the proprietary Fixed-Off-Time control, makes the device an excellent low-cost solution for EN61000-3-2 compliant SMPS in excess of 350W.

2 Pin settings

2.1 Pin connection

Figure 2. Pin connection (top view)



2.2 Pin description

Table 2. Pin description

Pin N°	Name	Description
1	INV	Inverting input of the error amplifier. The information on the output voltage of the PFC pre-regulator is fed into this pin through a resistor divider. The pin doubles as an ON/OFF control input.
2	COMP	Output of the error amplifier. A compensation network is placed between this pin and INV to achieve stability of the voltage control loop and ensure high power factor and low THD.
3	MULT	Main input to the multiplier. This pin is connected to the rectified mains voltage via a resistor divider and provides the sinusoidal reference to the current loop.
4	CS	Input to the PWM comparator. The current flowing in the MOSFET is sensed through a resistor, the resulting voltage is applied to this pin and compared with an internal sinusoidal-shaped reference, generated by the multiplier, to determine MOSFET's turn-off. The pin is equipped with 200 ns leading-edge blanking for improved noise immunity.
5	ZCD	Boost inductor's demagnetization sensing input for transition-mode operation. A negative-going edge triggers MOSFET's turn-on.
6	GND	Ground. Current return for both the signal part of the IC and the gate driver.
7	GD	Gate driver output. The totem pole output stage is able to drive power MOSFET's and IGBT's with a peak current of 600 mA source and 800 mA sink. The high-level voltage of this pin is clamped at about 12V to avoid excessive gate voltages in case the pin is supplied with a high Vcc.
8	Vcc	Supply Voltage of both the signal part of the IC and the gate driver. The supply voltage upper limit is extended to 22V min. to provide more headroom for supply voltage changes.

3 Maximum ratings

Table 3. Absolute maximum ratings

Symbol	Pin	Parameter	Value	Unit
V_{CC}	8	IC supply voltage ($I_{CC} \leq 20\text{mA}$)	Self-limited	V
I_{GD}	7	Output totem pole peak current	Self-limited	A
---	1 to 4	Analog inputs & outputs	-0.3 to 8	V
I_{ZCD}	5	Zero current detector max. current	± 10	mA

4 Thermal data

Table 4. Thermal data

Symbol	Parameter	Value		Unit
		SO8	DIP8	
R_{thJA}	Max. Thermal Resistance, Junction-to-ambient	150	100	$^{\circ}\text{C}/\text{W}$
P_{TOT}	Power Dissipation @ $T_A = 50^{\circ}\text{C}$	0.65	1	W
T_J	Junction Temperature Operating range	-40 to 150		$^{\circ}\text{C}$
T_{STG}	Storage Temperature	-55 to 150		$^{\circ}\text{C}$

5 Electrical characteristics

Table 5. Electrical characteristics

 (-25°C < T_J < +125°C, V_{CC} = 12V, C_o = 1nF; unless otherwise specified)

Symbol	Parameter	Test condition	Min	Typ	Max	Unit
Supply voltage						
V _{CC}	Operating range	After turn-on	10.5		22.5	V
V _{CCOn}	Turn-on threshold	(1)	11.7	12.5	13.3	V
V _{CCOff}	Turn-off threshold	(1)	9.5	10	10.5	V
Hys	Hysteresis		2.2		2.8	V
V _Z	Zener Voltage	I _{CC} = 20mA	22.5	25	28	V
Supply current						
I _{start-up}	Start-up current	Before turn-on, V _{CC} = 11V		30	60	μA
I _q	Quiescent current	After turn-on		2.5	3.75	mA
I _{CC}	Operating supply current	@ 70kHz		3.5	5	mA
I _q	Quiescent current	During OVP (either static or dynamic) or V _{INV} ≤ 150mV		1.7	2.2	mA
Multiplier input						
I _{MULT}	Input bias current	V _{MULT} = 0 to 4V			-1	μA
V _{MULT}	Linear operation range		0 to 3			V
$\frac{\Delta V_{cs}}{\Delta V_{MULT}}$	Output max. slope	V _{MULT} = 0 to 1V, V _{COMP} = Upper clamp	1	1.1		V/V
K	Gain ⁽²⁾	V _{MULT} = 1V, V _{COMP} = 4V,	0.32	0.38	0.44	V
Error amplifier						
V _{INV}	Voltage feedback input threshold	T _J = 25 °C	2.475	2.5	2.525	V
		10.5V < V _{CC} < 22.5V ⁽¹⁾	2.455		2.545	
	Line regulation	V _{CC} = 10.5V to 22.5V		2	5	mV
I _{INV}	Input bias current	V _{INV} = 0 to 3V			-1	μA
G _v	Voltage gain	Open loop	60	80		dB
GB	Gain-bandwidth product			1		MHz
I _{COMP}	Source current	V _{COMP} = 4V, V _{INV} = 2.4V	-2	-3.5	-5	mA
	Sink current	V _{COMP} = 4V, V _{INV} = 2.6V	2.5	4.5		mA

Table 5. Electrical characteristics (continued)(-25°C < T_J < +125°C, V_{CC} = 12V, C_o = 1nF; unless otherwise specified)

Symbol	Parameter	Test condition	Min	Typ	Max	Unit
V _{COMP}	Upper clamp voltage	I _{SOURCE} = 0.5mA	5.3	5.7	6	V
	Lower clamp voltage	I _{SINK} = 0.5mA ⁽¹⁾	2.1	2.25	2.4	V
V _{INVdis}	Disable threshold		150	200	250	mV
V _{INVen}	Restart threshold		380	450	520	mV
Output overvoltage						
I _{OVP}	Dynamic OVP triggering current		23.5	27	30.5	μA
Hys	Hysteresis	(3)		20		μA
	Static OVP threshold	(1)	2.1	2.25	2.4	V
Current sense comparator						
I _{CS}	Input bias current	V _{CS} = 0			-1	μA
t _{LEB}	Leading edge blanking		100	200	300	ns
td _(H-L)	Delay to output			175		ns
V _{CS}	Current sense clamp	V _{COMP} = Upper clamp, V _{MULT} = 1.5V	1.0	1.08	1.16	V
V _{CSoffset}	Current sense offset	V _{MULT} = 0		25		mV
		V _{MULT} = 2.5V		5		
Zero current detector						
V _{ZCDH}	Upper clamp voltage	I _{ZCD} = 2.5mA	5.0	5.7	6.5	V
V _{ZCDL}	Lower clamp voltage	I _{ZCD} = - 2.5mA	-0.3	0	0.3	V
V _{ZCDA}	Arming voltage (positive-going edge)	(3)		1.4		V
V _{ZCDT}	Triggering voltage (negative-going edge)	(3)		0.7		V
I _{ZCDb}	Input bias current	V _{ZCD} = 1 to 4.5V		2		μA
I _{ZCDsrc}	Source current capability		-2.5			mA
I _{ZCDsnk}	Sink current capability		2.5			mA
Starter						
t _{START}	Start timer period		75	190	300	μs

Table 5. Electrical characteristics (continued)(-25°C < T_J < +125°C, V_{CC} = 12V, C_o = 1nF; unless otherwise specified)

Symbol	Parameter	Test condition	Min	Typ	Max	Unit
Gate driver						
V _{OL}	Output low voltage	I _{sink} = 100mA		0.6	1.2	V
V _{OH}	Output high voltage	I _{source} = 5mA	9.8	10.3		V
I _{srcpk}	Peak source current		-0.6			A
I _{snkpk}	Peak sink current		0.8			A
t _f	Voltage fall time			30	70	ns
t _r	Voltage rise time			60	110	ns
V _{Oclamp}	Output clamp voltage	I _{source} = 5mA; V _{cc} = 20 V	10	12	15	V
	UVLO saturation	V _{cc} = 0 to V _{CCon} , I _{sink} = 2 mA			1.1	V

1. All the parameters are in tracking
2. The multiplier output is given by: $V_{cs} = K \cdot V_{MULT} \cdot (V_{COMP} - 2.5)$
3. Parameters guaranteed by design, functionality tested in production.

6 Typical electrical characteristic

Figure 3. Supply current vs supply voltage



Figure 4. Start-up & UVLO vs T_J

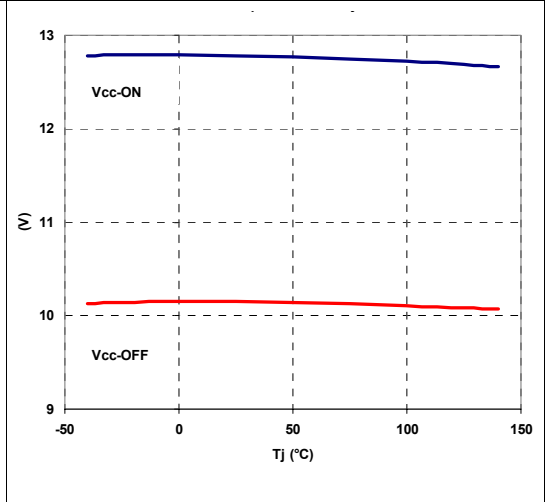

Figure 5. IC consumption vs T_J

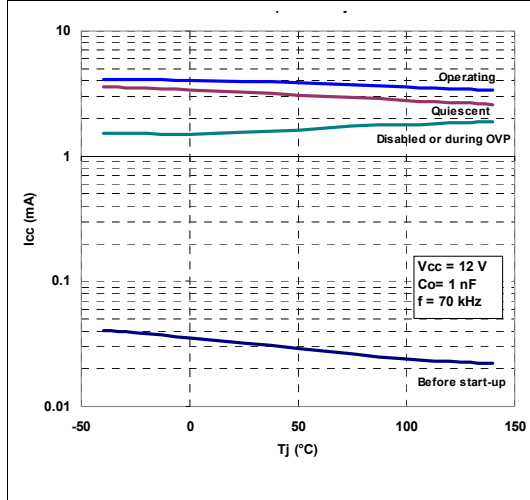

Figure 6. Vcc Zener voltage vs T_J

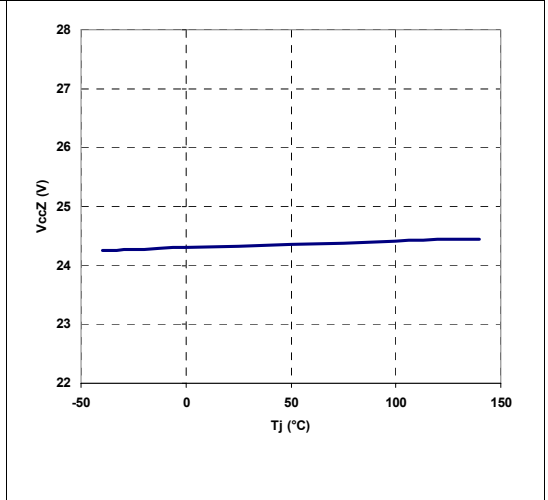

Figure 7. Feedback reference vs T_J

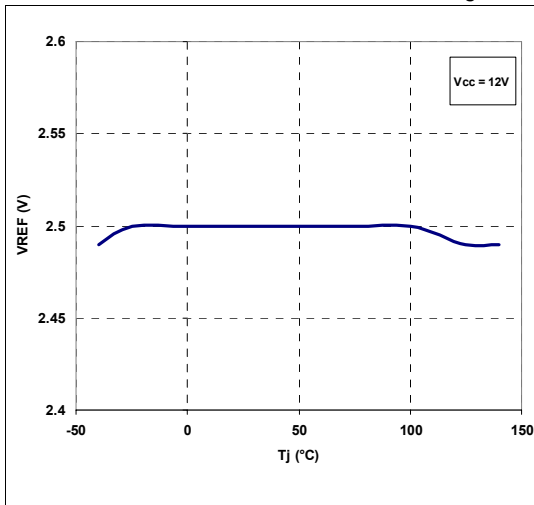

Figure 8. OVP current vs T_J

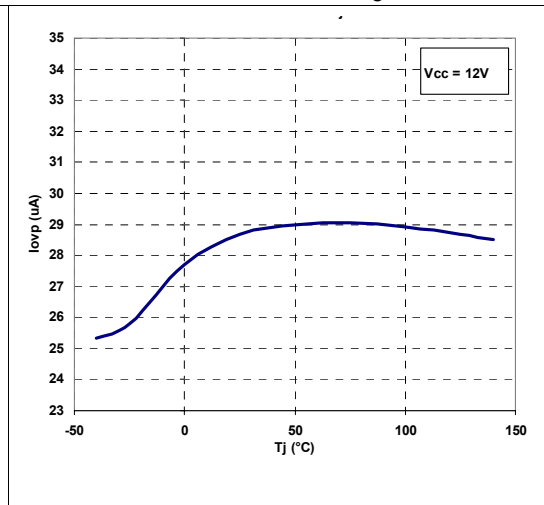

Figure 9. E/A output clamp levels vs T_J

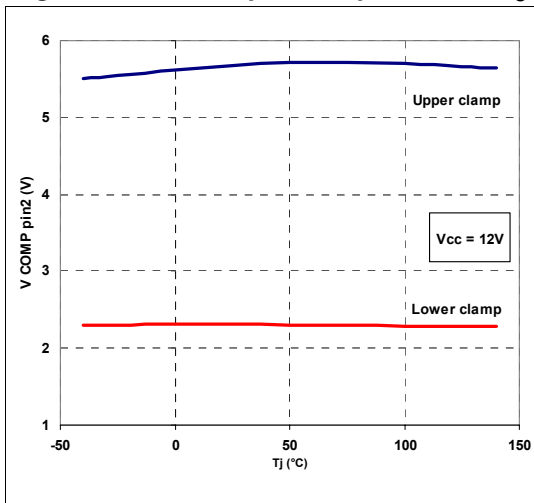

Figure 10. Delay-to-output vs T_J

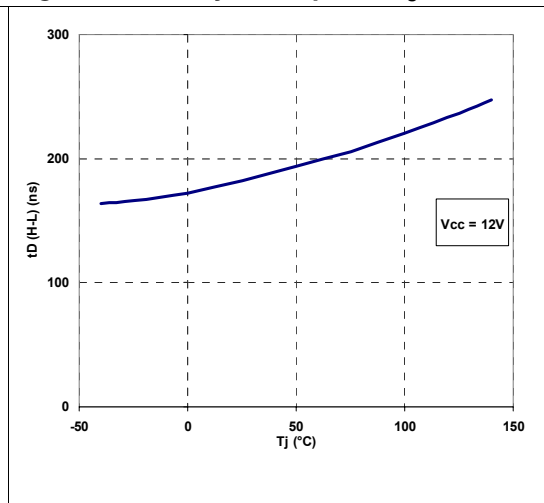

Figure 11. Multiplier characteristic

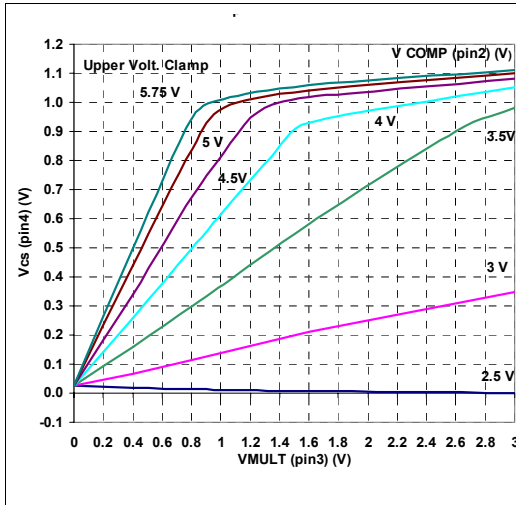

Figure 12. Vcs clamp vs T_J

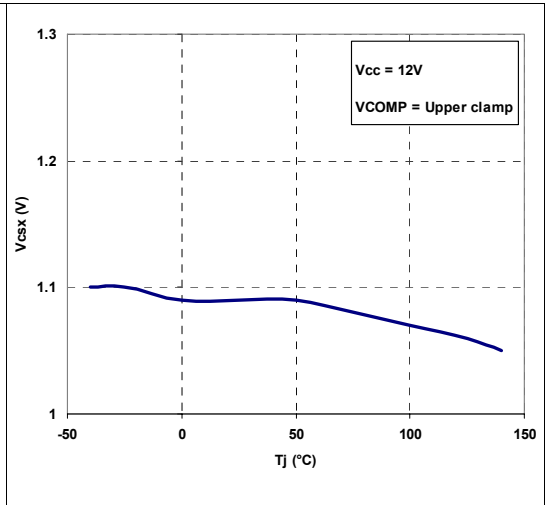

Figure 13. ZCD clamp levels vs T_J

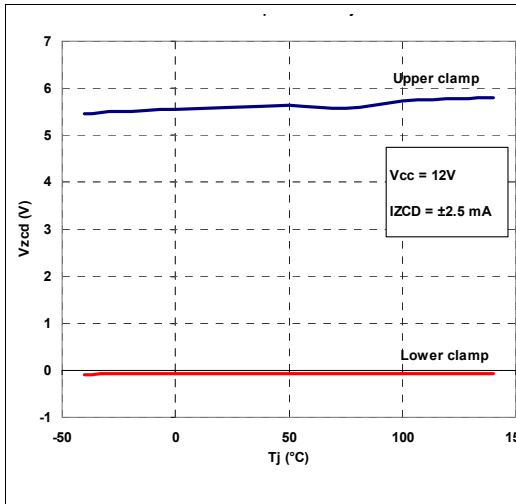

Figure 14. Start-up timer vs T_J

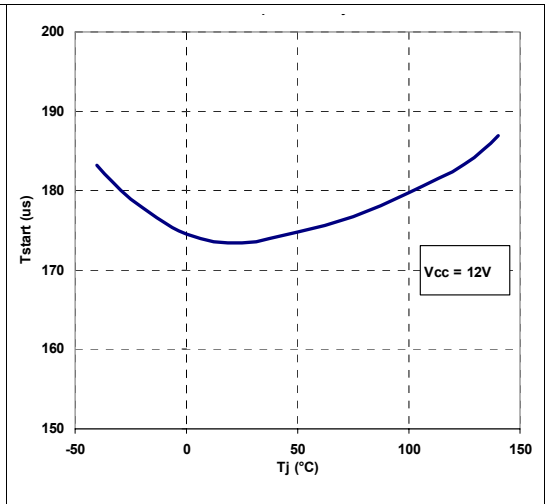

Figure 15. Gate-driver output low saturation



Figure 16. Gate-drive output high saturation



Figure 17. Gate-drive clamp vs TJ



Figure 18. Output gate drive low saturation vs TJ during UVLO



7 Application information

7.1 Overvoltage protection

Under steady-state conditions, the voltage control loop keeps the output voltage V_o of a PFC pre-regulator close to its nominal value, set by the resistors R_1 and R_2 of the output divider. Neglecting ripple components, the current through R_1 , I_{R1} , equals that through R_2 , I_{R2} . Considering that the non-inverting input of the error amplifier is internally referenced at 2.5V, also the voltage at pin INV will be 2.5V, then:

Equation 1

$$I_{R2} = I_{R1} = \frac{2.5}{R_2} = \frac{V_o - 2.5}{R_1}$$

If the output voltage experiences an abrupt change $\Delta V_o > 0$ due to a load drop, the voltage at pin INV will be kept at 2.5V by the local feedback of the error amplifier, a network connected between pins INV and COMP that introduces a long time constant to achieve high PF (this is why ΔV_o can be large). As a result, the current through R_2 will remain equal to $2.5/R_2$ but that through R_1 will become:

Equation 2

$$I'_{R1} = \frac{V_o - 2.5 + \Delta V_o}{R_1}$$

The difference current $\Delta I_{R1} = I'_{R1} - I_{R2} = I'_{R1} - I_{R1} = \Delta V_o / R_1$ will flow through the compensation network and enter the error amplifier output (pin COMP). This current is monitored inside the device and if it reaches about $24\mu A$ the output voltage of the multiplier is forced to decrease, thus smoothly reducing the energy delivered to the output. As the current exceeds $27\mu A$, the OVP is triggered (Dynamic OVP): the gate-drive is forced low to switch off the external power transistor and the IC put in an idle state. This condition is maintained until the current falls below approximately $7\mu A$, which re-enables the internal starter and allows switching to restart. The output ΔV_o that is able to trigger the Dynamic OVP function is then:

Equation 3

$$\Delta V_o = R_1 \cdot 20 \cdot 10^{-6}$$

An important advantage of this technique is that the OV level can be set independently of the regulated output voltage: the latter depends on the ratio of R_1 to R_2 , the former on the individual value of R_1 . Another advantage is the precision: the tolerance of the detection current is 13%, i.e. 13% tolerance on ΔV_o . Since $\Delta V_o \ll V_o$, the tolerance on the absolute value will be proportionally reduced.

Example: $V_o = 400V$, $\Delta V_o = 40V$. Then: $R_1 = 40V/27\mu A \approx 1.5M\Omega$;
 $R_2 = 1.5 M\Omega \cdot 2.5/(400-2.5) = 9.43k\Omega$. The tolerance on the OVP level due to the L6562A will be $40 \cdot 0.13 = 5.3V$, that is $\pm 1.2\%$.

When the load of a PFC pre-regulator is very low, the output voltage tends to stay steadily above the nominal value, which cannot be handled by the Dynamic OVP. If this occurs, however, the error amplifier output will saturate low; hence, when this is detected the external power transistor is switched off and the IC put in an idle state (Static OVP). Normal operation is resumed as the error amplifier goes back into its linear region. As a result, the device will work in burst-mode, with a repetition rate that can be very low.

When either OVP is activated the quiescent consumption of the IC is reduced to minimize the discharge of the Vcc capacitor and increase the hold-up capability of the IC supply system.

7.2 Disable function

The INV pin doubles its function as a not-latched IC disable: a voltage below 0.2V shuts down the IC and reduces its consumption at a lower value. To restart the IC, the voltage on the pin must exceed 0.45 V. The main usage of this function is a remote ON/OFF control input that can be driven by a PWM controller for power management purposes. However it also offers a certain degree of additional safety since it will cause the IC to shutdown in case the lower resistor of the output divider is shorted to ground or if the upper resistor is missing or fails open.

7.3 THD optimizer circuit

The device is equipped with a special circuit that reduces the conduction dead-angle occurring to the AC input current near the zero-crossings of the line voltage (crossover distortion). In this way the THD (Total Harmonic Distortion) of the current is considerably reduced.

A major cause of this distortion is the inability of the system to transfer energy effectively when the instantaneous line voltage is very low. This effect is magnified by the high-frequency filter capacitor placed after the bridge rectifier, which retains some residual voltage that causes the diodes of the bridge rectifier to be reverse-biased and the input current flow to temporarily stop.

Figure 19. THD optimization: standard TM PFC controller (left side) and L6562A (right side)



To overcome this issue the circuit embedded in the device forces the PFC pre-regulator to process more energy near the line voltage zero-crossings as compared to that commanded by the control loop. This will result in both minimizing the time interval where energy transfer is lacking and fully discharging the high-frequency filter capacitor after the bridge. The effect of the circuit is shown in figure 2, where the key waveforms of a standard TM PFC controller are compared to those of the L6562A.

Essentially, the circuit artificially increases the ON-time of the power switch with a positive offset added to the output of the multiplier in the proximity of the line voltage zero-crossings. This offset is reduced as the instantaneous line voltage increases, so that it becomes negligible as the line voltage moves toward the top of the sinusoid.

To maximally benefit from the THD optimizer circuit, the high-frequency filter capacitor after the bridge rectifier should be minimized, compatibly with EMI filtering needs. A large capacitance, in fact, introduces a conduction dead-angle of the AC input current in itself - even with an ideal energy transfer by the PFC pre-regulator - thus making the action of the optimizer circuit little effective.

7.4 Operating with no auxiliary winding on the boost inductor

To generate the synchronization signal on the ZCD pin, the typical approach requires the connection between the pin and an auxiliary winding of the boost inductor through a limiting resistor. When the device is supplied by the cascaded DC-DC converter, it is necessary to introduce a supplementary winding to the PFC choke just to operate the ZCD pin.

Another solution could be implemented by simply connecting the ZCD pin to the drain of the power MOSFET through an R-C network as shown in figure 3: in this way the high-frequency edges experienced by the drain will be transferred to the ZCD pin, hence arming and triggering the ZCD comparator.

Also in this case the resistance value must be properly chosen to limit the current sourced/sunk by the ZCD pin. In typical applications with output voltages around 400V, recommended values for these components are 22pF (or 33pF) for C_{ZCD} and 330k for R_{ZCD} . With these values proper operation is guaranteed even with few volts difference between the regulated output voltage and the peak input voltage

Figure 20. ZCD pin synchronization without auxiliary winding



7.5 Comparison between the L6562A and the L6562

The L6562A is not a direct drop-in replacement of the L6562, even if both have the same pin-out. One function (Disable) has been relocated.

Table 2 compares the two devices, i.e. those parameters that may result in different values of the external components. The parameters that have the most significant impact on the design, i.e. that definitely require external component changes when converting an L6562-based design to the L6562A, are highlighted in bold.

Table 6. L6562A vs. L6562

Parameter	L6562	L6562A
IC turn-on & turn-off thresholds (typ.)	12/9.5 V	12.5/10 V
Turn-off threshold spread (max.)	±0.8 V	±0.5 V
IC consumption before start-up (max.)	70 µA	60 µA
Multiplier gain (typ.)	0.6	0.38
Current sense reference clamp (typ.)	1.7 V	1.08 V
Current sense propagation delay (delay-to-output) (typ.)	200 ns	175 ns
Dynamic OVP triggering current (typ.)	40 µA	27 µA
ZCD arm/trigger/clamp thresholds (typ.)	2.1/1.4/0.7 V	1.4/0.7/0 V
Enable threshold (typ.)	0.3 V ⁽¹⁾	0.45 V ⁽²⁾
Gate-driver internal drop (max.)	2.6 V	2.2 V
Leading-edge blanking on current sense	No	Yes
Reference voltage accuracy (overall)	2.4%	1.8%

1. Function located on pin 5 (ZCD)

2. Function located on pin 1 (INV)

The lower value (-36%) for the clamp level of the current sense reference voltage allows the use of a lower sense resistor for the same peak current, with a proportional reduction of the associated power dissipation. Essentially, the advantage is the reduction of the power dissipated in a single point (hotspot), which is a considerable benefit in applications where heat removal is critical, e.g. in adapters enclosed in a sealed plastic case. The lower value for the Dynamic OVP triggering current allows the use of a higher resistance value (+48%) for the upper resistor of the divider sensing the output voltage of the PFC stage (keeping the same overvoltage level) with no significant increase of noise sensitivity. This reduction goes in favor of standby consumption in applications required to comply with energy saving regulations.

8 Application examples and ideas

Figure 21. Demo board EVL6562A-TM-80W, wide-range mains : electrical schematic

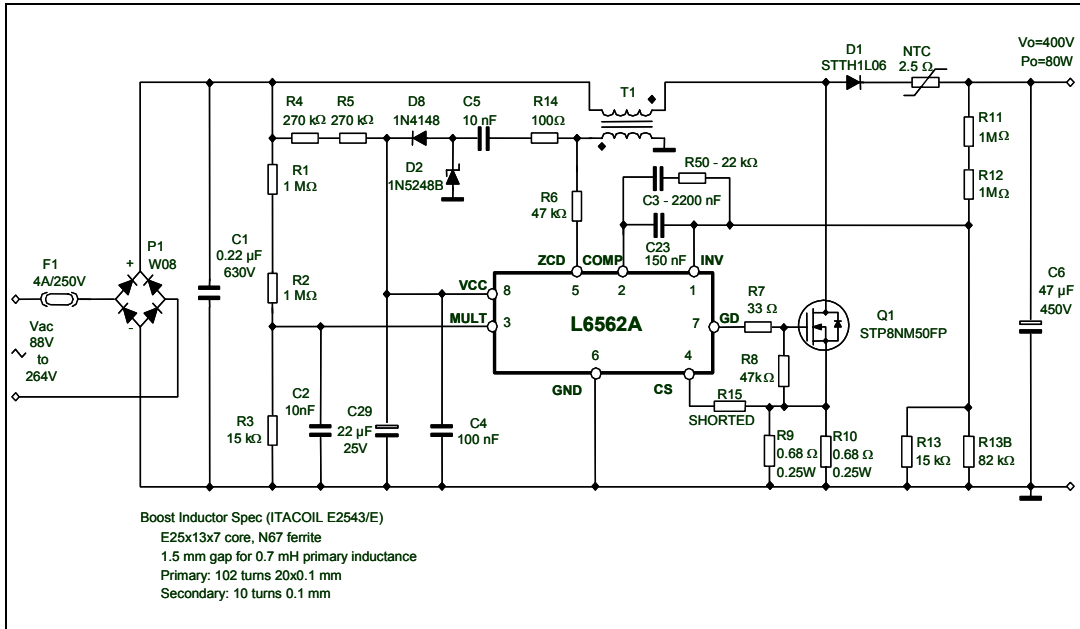

Figure 22. L6562A 80W TM PFC evaluation board: compliance to EN61000-3-2 standard



Figure 23. L6562A 80W TM PFC evaluation board: compliance to JEIDA-MITI standard



Figure 24. Figure 3 - L6562A 80W TM PFC Evaluation board: Input Current waveform @230V-50Hz – 80W load



Figure 25. Figure 4- L6562A 80W TM PFC Evaluation board: Input Current waveform @100V-50Hz – 80W load

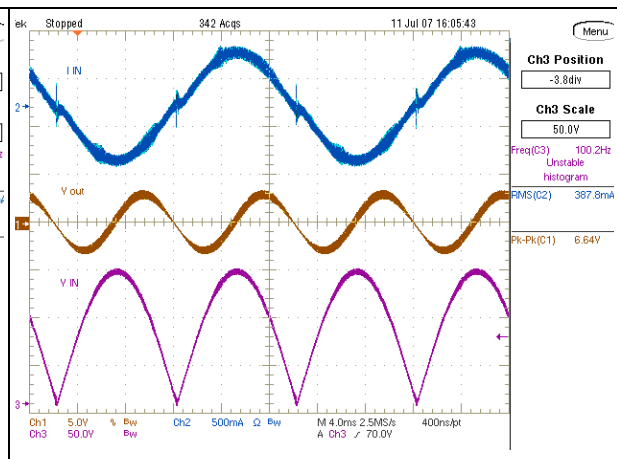

Figure 26. L6562A 80W TM PFC evaluation board: Power Factor vs Vin

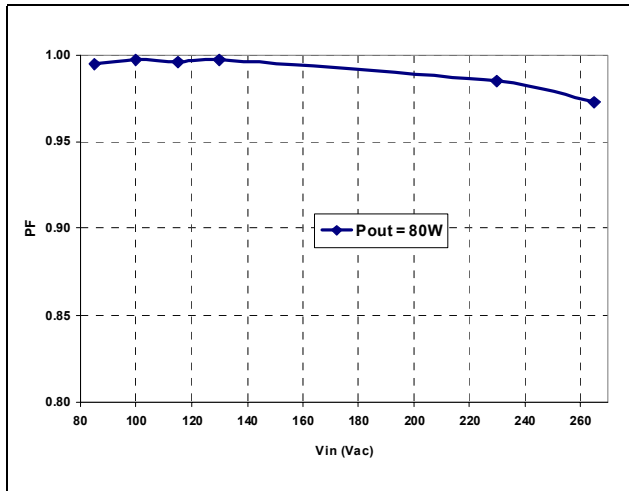

Figure 27. L6562A 80W TM PFC evaluation board: THD vs Vin

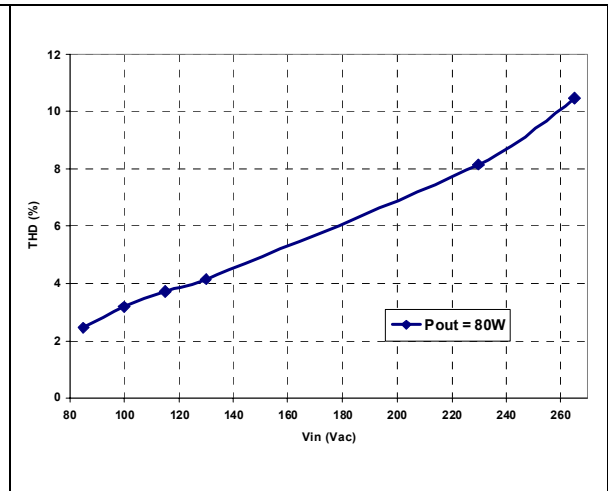

Figure 28. L6562A 80W TM PFC evaluation board: efficiency vs Vin

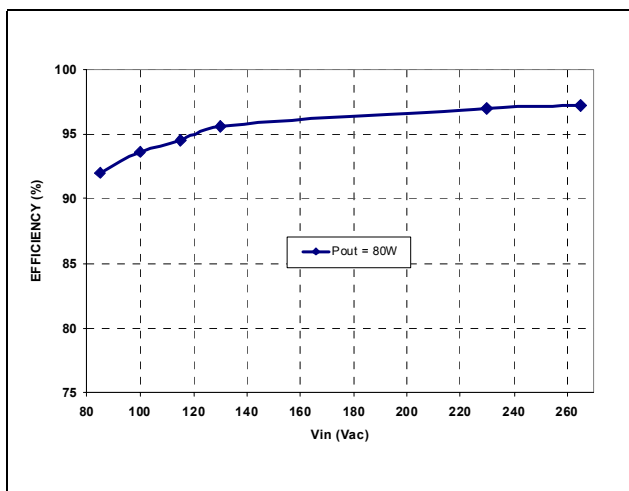
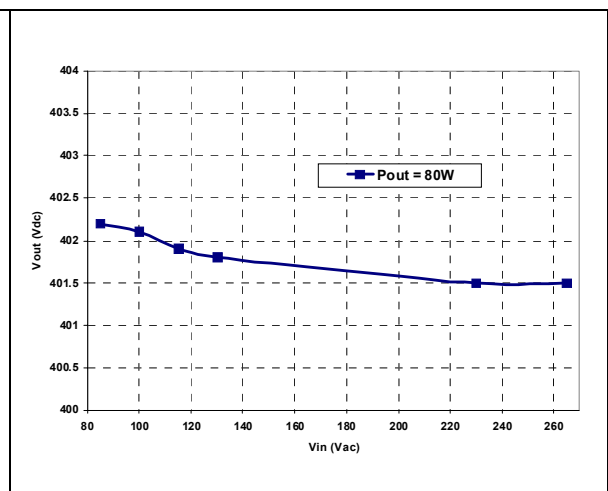

Figure 29. L6562A 80W TM PFC Evaluation board: Static Vout regulation vs Vin



9 Package mechanical data

In order to meet environmental requirements, ST offers these devices in ECOPACK® packages. These packages have a Lead-free second level interconnect . The category of second level interconnect is marked on the package and on the inner box label, in compliance with JEDEC Standard JESD97. The maximum ratings related to soldering conditions are also marked on the inner box label. ECOPACK is an ST trademark. ECOPACK specifications are available at: www.st.com

Table 7. DIP-8 mechanical data

Dim.	mm			Inch		
	Min	Typ	Max	Min	Typ	Max
A		3.32			0.131	
a1	0.51			0.020		
B	1.15		1.65	0.045		0.065
b	0.356		0.55	0.014		0.022
b1	0.204		0.304	0.008		0.012
D			10.92			0.430
E	7.95		9.75	0.313		0.384
e		2.54			0.100	
e3		7.62			0.300	
e4		7.62			0.300	
F			6.6			0.260
I			5.08			0.200
L	3.18		3.81	0.125		0.150
Z			1.52			0.060

Figure 31. Package dimensions



Table 8. SO-8 mechanical data

Dim.	mm.			inch		
	Min	Typ	Max	Min	Typ	Max
A	1.35		1.75	0.053		0.069
A1	0.10		0.25	0.004		0.010
A2	1.10		1.65	0.043		0.065
B	0.33		0.51	0.013		0.020
C	0.19		0.25	0.007		0.010
D (1)	4.80		5.00	0.189		0.197
E	3.80		4.00	0.15		0.157
e		1.27			0.050	
H	5.80		6.20	0.228		0.244
h	0.25		0.50	0.010		0.020
L	0.40		1.27	0.016		0.050
k	0° (min.), 8° (max.)					
ddd			0.10			0.004

1. Dimensions D does not include mold flash, protrusions or gate burrs. Mold flash, protrusions or gate burrs shall not exceed 0.15mm (.006inch) in total (both side).

Figure 32. Package dimensions



10 Revision history

Table 9. Revision history

Date	Revision	Changes
03-Mar-2007	1	First release
28-Jun-2007	2	Updated electrical characteristics
07-Aug-2007	3	Added <i>Chapter 6: Typical electrical characteristic on page 9</i>

Please Read Carefully:

Information in this document is provided solely in connection with ST products. STMicroelectronics NV and its subsidiaries ("ST") reserve the right to make changes, corrections, modifications or improvements, to this document, and the products and services described herein at any time, without notice.

All ST products are sold pursuant to ST's terms and conditions of sale.

Purchasers are solely responsible for the choice, selection and use of the ST products and services described herein, and ST assumes no liability whatsoever relating to the choice, selection or use of the ST products and services described herein.

No license, express or implied, by estoppel or otherwise, to any intellectual property rights is granted under this document. If any part of this document refers to any third party products or services it shall not be deemed a license grant by ST for the use of such third party products or services, or any intellectual property contained therein or considered as a warranty covering the use in any manner whatsoever of such third party products or services or any intellectual property contained therein.

UNLESS OTHERWISE SET FORTH IN ST'S TERMS AND CONDITIONS OF SALE ST DISCLAIMS ANY EXPRESS OR IMPLIED WARRANTY WITH RESPECT TO THE USE AND/OR SALE OF ST PRODUCTS INCLUDING WITHOUT LIMITATION IMPLIED WARRANTIES OF MERCHANTABILITY, FITNESS FOR A PARTICULAR PURPOSE (AND THEIR EQUIVALENTS UNDER THE LAWS OF ANY JURISDICTION), OR INFRINGEMENT OF ANY PATENT, COPYRIGHT OR OTHER INTELLECTUAL PROPERTY RIGHT.

UNLESS EXPRESSLY APPROVED IN WRITING BY AN AUTHORIZED ST REPRESENTATIVE, ST PRODUCTS ARE NOT RECOMMENDED, AUTHORIZED OR WARRANTED FOR USE IN MILITARY, AIR CRAFT, SPACE, LIFE SAVING, OR LIFE SUSTAINING APPLICATIONS, NOR IN PRODUCTS OR SYSTEMS WHERE FAILURE OR MALFUNCTION MAY RESULT IN PERSONAL INJURY, DEATH, OR SEVERE PROPERTY OR ENVIRONMENTAL DAMAGE. ST PRODUCTS WHICH ARE NOT SPECIFIED AS "AUTOMOTIVE GRADE" MAY ONLY BE USED IN AUTOMOTIVE APPLICATIONS AT USER'S OWN RISK.

Resale of ST products with provisions different from the statements and/or technical features set forth in this document shall immediately void any warranty granted by ST for the ST product or service described herein and shall not create or extend in any manner whatsoever, any liability of ST.

ST and the ST logo are trademarks or registered trademarks of ST in various countries.

Information in this document supersedes and replaces all information previously supplied.

The ST logo is a registered trademark of STMicroelectronics. All other names are the property of their respective owners.

© 2007 STMicroelectronics - All rights reserved

STMicroelectronics group of companies

Australia - Belgium - Brazil - Canada - China - Czech Republic - Finland - France - Germany - Hong Kong - India - Israel - Italy - Japan - Malaysia - Malta - Morocco - Singapore - Spain - Sweden - Switzerland - United Kingdom - United States of America

www.st.com



Компания «ЭлектроПласт» предлагает заключение долгосрочных отношений при поставках импортных электронных компонентов на взаимовыгодных условиях!

Наши преимущества:

- Оперативные поставки широкого спектра электронных компонентов отечественного и импортного производства напрямую от производителей и с крупнейших мировых складов;
- Поставка более 17-ти миллионов наименований электронных компонентов;
- Поставка сложных, дефицитных, либо снятых с производства позиций;
- Оперативные сроки поставки под заказ (от 5 рабочих дней);
- Экспресс доставка в любую точку России;
- Техническая поддержка проекта, помощь в подборе аналогов, поставка прототипов;
- Система менеджмента качества сертифицирована по Международному стандарту ISO 9001;
- Лицензия ФСБ на осуществление работ с использованием сведений, составляющих государственную тайну;
- Поставка специализированных компонентов (Xilinx, Altera, Analog Devices, Intersil, Interpoint, Microsemi, Aeroflex, Peregrine, Syfer, Eurofarad, Texas Instrument, Miteq, Cobham, E2V, MA-COM, Hittite, Mini-Circuits, General Dynamics и др.);

Помимо этого, одним из направлений компании «ЭлектроПласт» является направление «Источники питания». Мы предлагаем Вам помощь Конструкторского отдела:

- Подбор оптимального решения, техническое обоснование при выборе компонента;
- Подбор аналогов;
- Консультации по применению компонента;
- Поставка образцов и прототипов;
- Техническая поддержка проекта;
- Защита от снятия компонента с производства.



Как с нами связаться

Телефон: 8 (812) 309 58 32 (многоканальный)

Факс: 8 (812) 320-02-42

Электронная почта: org@eplast1.ru

Адрес: 198099, г. Санкт-Петербург, ул. Калинина, дом 2, корпус 4, литера А.