

Features

- Low Insertion Loss: 0.3 dB @ 900 MHz
- Low Current Consumption: <15 μ A @ +2.5 V
- Positive or Negative 2.5 to 8 V Control
- Lead-Free SOT-363 Package
- 100% Matte Tin Plating over Copper
- Halogen-Free "Green" Mold Compound
- 260°C Reflow Compatible
- RoHS* Compliant Version of SW-437

Description

M/A-COM's MASWSS0166 is a GaAs monolithic switch in a lead-free SOT-363 surface mount plastic package. The MASWSS0166 is ideally suited for applications where very low power consumption, low insertion loss, very small size and low cost are required.

Typical applications are dual band systems that require switching between small signal components such as filter banks, single band LNA's and converters. The MASWSS0166 can be used in applications up to 0.25 Watts in systems such as cellular, PCS, DCS1800, GSM, CDMA, W-CDMA and other analog/digital wireless communications systems.

The MASWSS0166 is fabricated using a mature 0.5 micron GaAs PHEMT process. The process features full passivation for increased performance and reliability.

Absolute Maximum Ratings ^{1,2}

Parameter	Absolute Maximum
Input Power (0.5-3.0 GHz) 3 V Control 5 V Control	+30 dBm +33 dBm
Operating Voltage	+8.5 Volts
Operating Temperature	-40°C to +85°C
Storage Temperature	-65°C to +150°C

1. Exceeding any one or combination of these limits may cause permanent damage to this device.
2. M/A-COM does not recommend sustained operation near these survivability limits.

Functional Schematic:

Positive Control Voltage

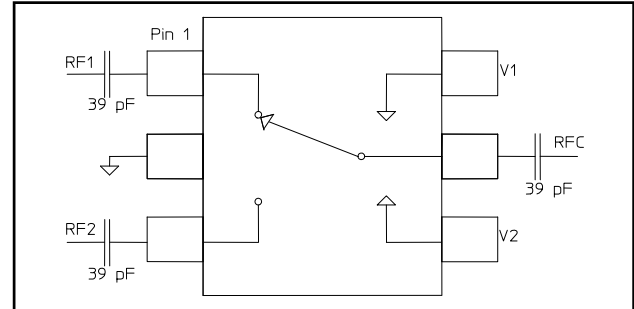

Functional Schematic:

Negative Control Voltage

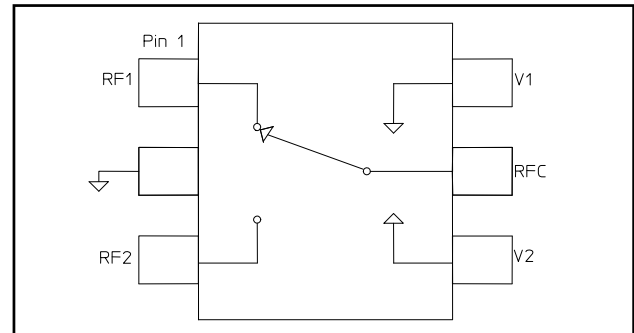

Pin Configuration

Pin No.	Function	Description
1	RF1	RF in/out
2	GND	RF Ground
3	RF2	RF in/out
4	V2	V Control 2
5	RFC	RF Common
6	V1	V Control 1

Ordering Information ³

Part Number	Package
MASWSS0166	Bulk Packaging
MASWSS0166TR-3000	3000 piece reel
MASWSS0166SMB	Sample Test Board

3. Reference Application Note M513 for reel size information.

* Restrictions on Hazardous Substances, European Union Directive 2002/95/EC.

ADVANCED: Data Sheets contain information regarding a product M/A-COM Technology Solutions is considering for development. Performance is based on target specifications, simulated results, and/or prototype measurements. Commitment to develop is not guaranteed.
PRELIMINARY: Data Sheets contain information regarding a product M/A-COM Technology Solutions has under development. Performance is based on engineering tests. Specifications are typical. Mechanical outline has been fixed. Engineering samples and/or test data may be available. Commitment to produce in volume is not guaranteed.

• **North America** Tel: 800.366.2266 / Fax: 978.366.2266
 • **Europe** Tel: 44.1908.574.200 / Fax: 44.1908.574.300
 • **Asia/Pacific** Tel: 81.44.844.8296 / Fax: 81.44.844.8298
 Visit www.macomtech.com for additional data sheets and product information.

M/A-COM Technology Solutions Inc. and its affiliates reserve the right to make changes to the product(s) or information contained herein without notice.

GaAs SPDT Switch DC - 3.0 GHz

Rev. V2

Electrical Specifications: $T_A = 25^\circ\text{C}$, $V_c = 0\text{ V} / -2.5\text{ V}$, $Z_0 = 50\Omega$ ⁴

Parameter	Test Conditions	Units	Min.	Typ.	Max.
Insertion Loss	DC - 1 GHz	dB	—	0.3	0.4
	1 - 2 GHz	dB	—	0.4	0.5
	2 - 3 GHz	dB	—	0.55	0.7
Isolation	DC - 1 GHz	dB	19	21	—
	1 - 2 GHz	dB	13	15	—
	2 - 3 GHz	dB	10	12	—
VSWR	DC - 3 GHz	Ratio	—	1.2:1	—
P_{1dB}	500 MHz - 3 GHz, $ V_c = 2.7\text{ V}$	dBm	—	24	—
P_{1dB}	500 MHz - 3 GHz, $ V_c = 5\text{ V}$	dBm	—	27	—
Input IP_2	2-Tone, 900 MHz, 5 MHz spacing, $ V_c = 2.7\text{ V}$	dBm	—	81	—
Input IP_3	2-Tone 900 MHz, 5 MHz spacing, $ V_c = 2.7\text{ V}$	dBm	—	55	—
Trise, Tfall Ton, Toff Transients	10% to 90% RF, 90% to 10% RF	nS	—	10	—
	50% Control to 90% RF, 50% Control to 10% RF	nS	—	20	—
	In-Band	mV	—	10	—
Control Current	$ V_c = 2.5\text{ V}$	μA	—	4	15

4. For positive voltage control, external DC blocking capacitors are required on all RF ports.

Lead-Free SOT-363 Plastic Package[†]

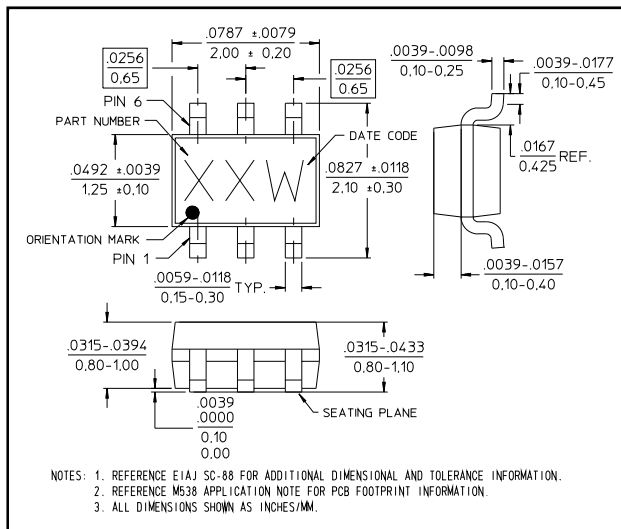

[†] Reference Application Note M538 for lead-free solder reflow recommendations.

Truth Table^{5,6}

V1	V2	RFC-RF1	RFC-RF2
0	1	On	Off
1	0	Off	On

- Differential voltage, $V(\text{state } 1) - V(\text{state } 0)$, must be +2.5 V minimum and must not exceed 8 V.
- 0 = -8 V to 0 V, 1 = -5.5 V to 8 V

Handling Procedures

Please observe the following precautions to avoid damage:

Static Sensitivity

Gallium Arsenide Integrated Circuits are sensitive to electrostatic discharge (ESD) and can be damaged by static electricity. Proper ESD control techniques should be used when handling these devices.

Typical Performance Curves

Insertion Loss (Negative Voltage Control)

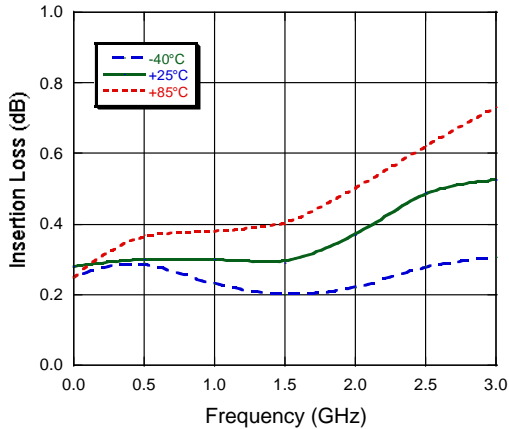

Insertion Loss (Positive Voltage Control)

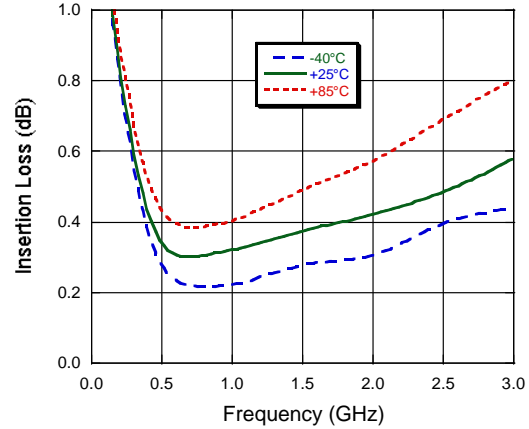

Isolation

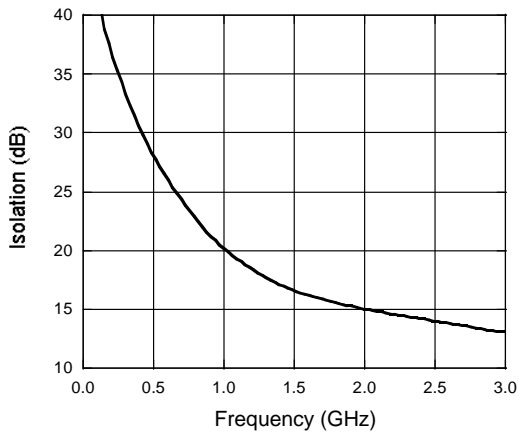

VSWR

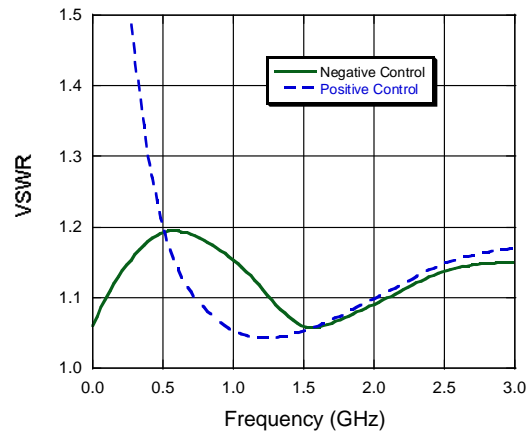



Компания «ЭлектроПласт» предлагает заключение долгосрочных отношений при поставках импортных электронных компонентов на взаимовыгодных условиях!

Наши преимущества:

- Оперативные поставки широкого спектра электронных компонентов отечественного и импортного производства напрямую от производителей и с крупнейших мировых складов;
- Поставка более 17-ти миллионов наименований электронных компонентов;
- Поставка сложных, дефицитных, либо снятых с производства позиций;
- Оперативные сроки поставки под заказ (от 5 рабочих дней);
- Экспресс доставка в любую точку России;
- Техническая поддержка проекта, помощь в подборе аналогов, поставка прототипов;
- Система менеджмента качества сертифицирована по Международному стандарту ISO 9001;
- Лицензия ФСБ на осуществление работ с использованием сведений, составляющих государственную тайну;
- Поставка специализированных компонентов (Xilinx, Altera, Analog Devices, Intersil, Interpoint, Microsemi, Aeroflex, Peregrine, Syfer, Eurofarad, Texas Instrument, Miteq, Cobham, E2V, MA-COM, Hittite, Mini-Circuits, General Dynamics и др.);

Помимо этого, одним из направлений компании «ЭлектроПласт» является направление «Источники питания». Мы предлагаем Вам помощь Конструкторского отдела:

- Подбор оптимального решения, техническое обоснование при выборе компонента;
- Подбор аналогов;
- Консультации по применению компонента;
- Поставка образцов и прототипов;
- Техническая поддержка проекта;
- Защита от снятия компонента с производства.



Как с нами связаться

Телефон: 8 (812) 309 58 32 (многоканальный)

Факс: 8 (812) 320-02-42

Электронная почта: org@eplast1.ru

Адрес: 198099, г. Санкт-Петербург, ул. Калинина, дом 2, корпус 4, литера А.