



Main

Range of product	Modicon M251
Product or component type	Logic controller
[Us] rated supply voltage	24 V DC

Complementary

Number of I/O expansion module	7 with local I/O architecture 14 with remote I/O architecture
Supply voltage limits	20.4...28.8 V
Inrush current	<= 50 A
Power consumption in W	32.6...40.4 W with max number of I/O expansion module
Memory capacity	8 MB program 64 MB system memory RAM
Data backed up	128 MB built-in flash memory backup of user programs
Data storage equipment	<= 32 GB SD card optional
Battery type	BR2032 lithium non-rechargeable, battery life: 4 yr
Backup time	2 years at 77 °F (25 °C)
Execution time for 1 KInstruction	0.3 ms event and periodic task 0.7 ms other instruction
Execution time per instruction	0.022 µs
Application structure	8 event tasks 4 cyclic master tasks 3 cyclic master tasks + 1 freewheeling task 8 external event tasks
Realtime clock	With
Clock drift	<= 60 s/month at 77 °F (25 °C)
Integrated connection type	USB port with mini B USB 2.0 connector Non isolated serial link "serial" with RJ45 connector; physical interface: RS232/RS485 Dual-port "Ethernet" with RJ45 connector CANopen J1939 with SUB-D 9 connector
Supply	5 V at 200 mA serial link supply with "serial" marking
Transmission rate	1.2...115.2 kbit/s (115.2 kbit/s by default) for bus length of 15 m - communication protocol: RS485 1.2...115.2 kbit/s (115.2 kbit/s by default) for bus length of 9.84 ft (3 m) - communication protocol: RS232 480 Mbit/s for bus length of 9.84 ft (3 m) - communication protocol: USB
Communication port protocol	USB port - USB protocol ; transmission frame: SoMachine-Network Non isolated serial link - Modbus protocol ; transmission frame: RTU/ASCII or SoMachine-Network with master/slave method
Port Ethernet	"Ethernet" marking 10BASE-T/100BASE-TX - 2 port copper cable
Web services	Web server
Communication service	DHCP client Downloading Ethernet/IP slave device IEC VAR ACCESS Modbus TCP client Modbus TCP server Modbus TCP slave device

The information provided in this documentation contains general descriptions and/or technical characteristics of the products contained herein. This documentation is not intended as a substitute for and is not to be used for determining suitability or reliability of these products for specific user applications. It is the duty of any such user or integrator to perform the appropriate and complete risk analysis, evaluation and testing of the products with respect to the relevant specific application or use thereof. Neither Schneider Electric Industries SAS nor any of its affiliates or subsidiaries shall be responsible or liable for misuse of the information contained herein.

	Monitoring NGVL Programming Updating firmware SMS notifications SNMP client/server FTP client/server SQL client Send and receive email from the controller based on TCP/UDP library Web server (WebVisu & XWeb system) OPC UA server DNS client
Maximum number of connections	8 Modbus server 8 Modbus client 16 Ethernet/IP target 4 FTP server 10 web server 8 SoMachine protocol
CANopen feature profile	DR 303-1 DS 301 V4.02
Number of slave	<= 63 CANopen
Local signalling	1 LED red module error (ERR) 1 LED green PWR 1 LED green RUN 1 LED green SD card access (SD) 1 LED red BAT 1 LED green SL 1 LED red I/O error (I/O) 1 LED red bus fault on TM4 (TM4) 1 LED green Ethernet port activity 1 LED green CANopen run 1 LED green CANopen error
Electrical connection	Removable screw terminal block power supply with pitch 5.08 mm adjustment
Insulation	Non-insulated between supply and internal logic Between supply and ground at 500 V AC
Marking	CE
Surge withstand	1 kV (shielded cable) with common mode protection conforming to EN/IEC 61000-4-5 1 kV (power lines) with common mode protection conforming to EN/IEC 61000-4-5 0.5 kV (power lines) with differential mode protection conforming to EN/IEC 61000-4-5
Mounting support	Top hat type TH35-15 rail conforming to IEC 60715 Top hat type TH35-7.5 rail conforming to IEC 60715 Plate or panel with fixing kit
Height	3.54 in (90 mm)
Depth	3.74 in (95 mm)
Width	2.13 in (54 mm)
Product weight	0.49 lb(US) (0.22 kg)

Environment

standards	UL 508 CSA C22.2 No 142 ANSI/ISA 12-12-01 UL 1604 CSA C22.2 No 213 EN/IEC 61131-2 : 2007 Marine specification (LR, ABS, DNV, GL)
product certifications	CSA CULus
resistance to electrostatic discharge	4 kV (on contact) conforming to EN/IEC 61000-4-2 8 kV (in air) conforming to EN/IEC 61000-4-2
resistance to electromagnetic fields	9.14 V/yd (10 V/m) (80 MHz...1 GHz) conforming to EN/IEC 61000-4-3 2.74 V/yd (3 V/m) (1.4 GHz...2 GHz) conforming to EN/IEC 61000-4-3 0.91 V/yd (1 V/m) (2 GHz...3 GHz) conforming to EN/IEC 61000-4-3
resistance to fast transients	2 kV (power lines) conforming to EN/IEC 61000-4-4 1 kV (Ethernet line) conforming to EN/IEC 61000-4-4 1 kV (serial link) conforming to EN/IEC 61000-4-4
resistance to conducted disturbances	10 V (0.15...80 MHz) conforming to EN/IEC 61000-4-6 3 V (0.1...80 MHz) conforming to Marine specification (LR, ABS, DNV, GL) 10 V (spot frequency (2, 3, 4, 6.2, 8.2, 12.6, 16.5, 18.8, 22, 25 MHz)) conforming to

electromagnetic emission	Conducted emissions - test level: 120...69 dB μ V/m QP (power lines) at 10...150 kHz conforming to EN/IEC 55011 Conducted emissions - test level: 63 dB μ V/m QP (power lines) at 1.5...30 MHz conforming to EN/IEC 55011 Radiated emissions - test level: 40 dB μ V/m QP class A (10 m) at 30...230 MHz conforming to EN/IEC 55011 Conducted emissions - test level: 79...63 dB μ V/m QP (power lines) at 150...1500 kHz conforming to EN/IEC 55011 Radiated emissions - test level: 47 dB μ V/m QP class A (10 m) at 230...1000 MHz conforming to EN/IEC 55011
immunity to microbreaks	10 ms
ambient air temperature for operation	14...131 °F (-10...55 °C) horizontal installation -10...35 °C vertical installation
ambient air temperature for storage	-13...158 °F (-25...70 °C)
relative humidity	10...95 % without condensation in operation 10...95 % without condensation in storage
IP degree of protection	IP20 with protective cover in place
pollution degree	2
operating altitude	0...6561.68 ft (0...2000 m)
storage altitude	0...9842.52 ft (0...3000 m)
vibration resistance	3.5 mm at 5...8.4 Hz on symmetrical rail 3 gn at 8.4...150 Hz on symmetrical rail 3.5 mm at 5...8.4 Hz on panel mounting 3 gn at 8.4...150 Hz on panel mounting
shock resistance	15 gn during 11 ms

Offer Sustainability

Green Premium product	Green Premium product
Compliant - since 1350 - Schneider Electric declaration of conformity	Compliant - since 1350 - Schneider Electric declaration of conformity
Reference not containing SVHC above the threshold	Reference not containing SVHC above the threshold
Available	Available
Available	Available
WARNING: This product can expose you to chemicals including:	WARNING: This product can expose you to chemicals including:
Lead and lead compounds, which is known to the State of California to cause cancer and birth defects or other reproductive harm.	Lead and lead compounds, which is known to the State of California to cause cancer and birth defects or other reproductive harm.
For more information go to www.p65warnings.ca.gov	For more information go to www.p65warnings.ca.gov

Dimensions

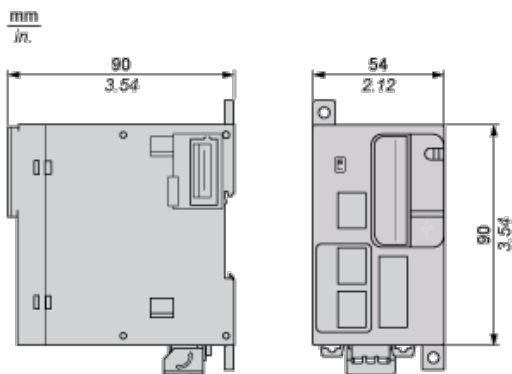

Clearance

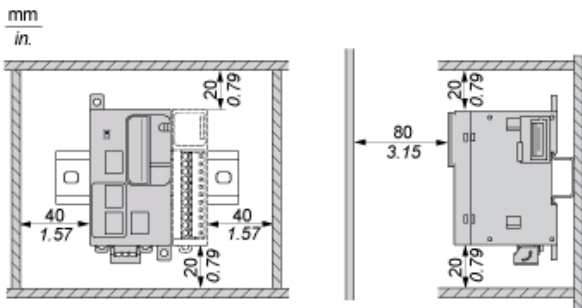

Mounting Position

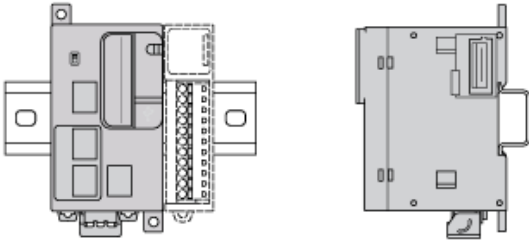

NOTE: Keep adequate spacing for proper ventilation and to maintain an ambient temperature between -10°C (14°F) and 55°C (131°F).

Acceptable Mounting

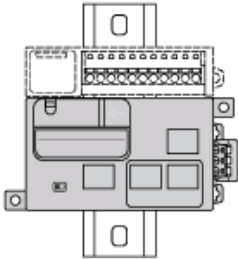

NOTE: Expansion modules must be mounted above the controller.

Incorrect Mounting

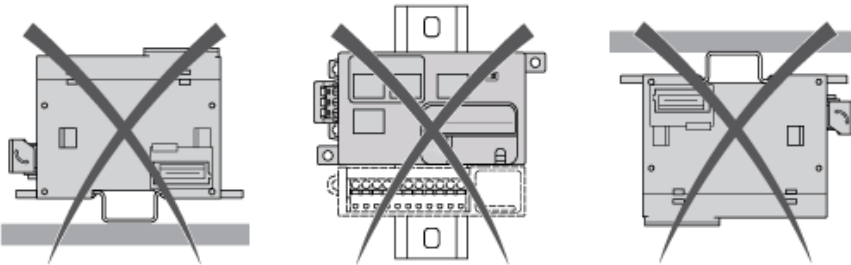

Direct Mounting on a Panel Surface

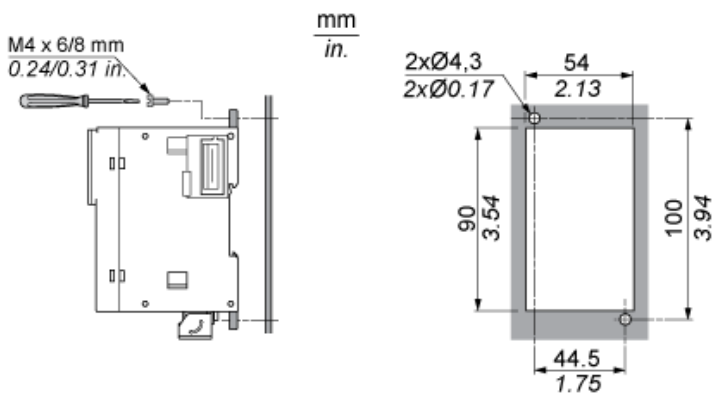

USB Connection to a PC



Ethernet Connection to a PC



CANopen

Wiring

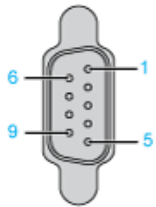

Pin	Signal	Description
1	–	Reserved
2	CAN_L	CAN_L bus line
3	CAN_GND	CAN ground
4	–	Reserved
5	(CAN_SHLD)	Optional CAN shield
6	GND	Ground
7	CAN_H	CAN_H bus line
8	–	Reserved
9	(CAN_V+)	Optional CAN external positive supply



Компания «ЭлектроПласт» предлагает заключение долгосрочных отношений при поставках импортных электронных компонентов на взаимовыгодных условиях!

Наши преимущества:

- Оперативные поставки широкого спектра электронных компонентов отечественного и импортного производства напрямую от производителей и с крупнейших мировых складов;
- Поставка более 17-ти миллионов наименований электронных компонентов;
- Поставка сложных, дефицитных, либо снятых с производства позиций;
- Оперативные сроки поставки под заказ (от 5 рабочих дней);
- Экспресс доставка в любую точку России;
- Техническая поддержка проекта, помощь в подборе аналогов, поставка прототипов;
- Система менеджмента качества сертифицирована по Международному стандарту ISO 9001;
- Лицензия ФСБ на осуществление работ с использованием сведений, составляющих государственную тайну;
- Поставка специализированных компонентов (Xilinx, Altera, Analog Devices, Intersil, Interpoint, Microsemi, Aeroflex, Peregrine, Syfer, Eurofarad, Texas Instrument, Miteq, Cobham, E2V, MA-COM, Hittite, Mini-Circuits, General Dynamics и др.);

Помимо этого, одним из направлений компании «ЭлектроПласт» является направление «Источники питания». Мы предлагаем Вам помощь Конструкторского отдела:

- Подбор оптимального решения, техническое обоснование при выборе компонента;
- Подбор аналогов;
- Консультации по применению компонента;
- Поставка образцов и прототипов;
- Техническая поддержка проекта;
- Защита от снятия компонента с производства.



Как с нами связаться

Телефон: 8 (812) 309 58 32 (многоканальный)

Факс: 8 (812) 320-02-42

Электронная почта: org@eplast1.ru

Адрес: 198099, г. Санкт-Петербург, ул. Калинина, дом 2, корпус 4, литера А.