



Is Now Part of



**ON Semiconductor®**

To learn more about ON Semiconductor, please visit our website at  
[www.onsemi.com](http://www.onsemi.com)

Please note: As part of the Fairchild Semiconductor integration, some of the Fairchild orderable part numbers will need to change in order to meet ON Semiconductor's system requirements. Since the ON Semiconductor product management systems do not have the ability to manage part nomenclature that utilizes an underscore (\_), the underscore (\_) in the Fairchild part numbers will be changed to a dash (-). This document may contain device numbers with an underscore (\_). Please check the ON Semiconductor website to verify the updated device numbers. The most current and up-to-date ordering information can be found at [www.onsemi.com](http://www.onsemi.com). Please email any questions regarding the system integration to [Fairchild\\_questions@onsemi.com](mailto:Fairchild_questions@onsemi.com).

ON Semiconductor and the ON Semiconductor logo are trademarks of Semiconductor Components Industries, LLC dba ON Semiconductor or its subsidiaries in the United States and/or other countries. ON Semiconductor owns the rights to a number of patents, trademarks, copyrights, trade secrets, and other intellectual property. A listing of ON Semiconductor's product/patent coverage may be accessed at [www.onsemi.com/site/pdf/Patent-Marking.pdf](http://www.onsemi.com/site/pdf/Patent-Marking.pdf). ON Semiconductor reserves the right to make changes without further notice to any products herein. ON Semiconductor makes no warranty, representation or guarantee regarding the suitability of its products for any particular purpose, nor does ON Semiconductor assume any liability arising out of the application or use of any product or circuit, and specifically disclaims any and all liability, including without limitation special, consequential or incidental damages. Buyer is responsible for its products and applications using ON Semiconductor products, including compliance with all laws, regulations and safety requirements or standards, regardless of any support or applications information provided by ON Semiconductor. "Typical" parameters which may be provided in ON Semiconductor data sheets and/or specifications can and do vary in different applications and actual performance may vary over time. All operating parameters, including "Typicals" must be validated for each customer application by customer's technical experts. ON Semiconductor does not convey any license under its patent rights nor the rights of others. ON Semiconductor products are not designed, intended, or authorized for use as a critical component in life support systems or any FDA Class 3 medical devices or medical devices with a same or similar classification in a foreign jurisdiction or any devices intended for implantation in the human body. Should Buyer purchase or use ON Semiconductor products for any such unintended or unauthorized application, Buyer shall indemnify and hold ON Semiconductor and its officers, employees, subsidiaries, affiliates, and distributors harmless against all claims, costs, damages, and expenses, and reasonable attorney fees arising out of, directly or indirectly, any claim of personal injury or death associated with such unintended or unauthorized use, even if such claim alleges that ON Semiconductor was negligent regarding the design or manufacture of the part. ON Semiconductor is an Equal Opportunity/Affirmative Action Employer. This literature is subject to all applicable copyright laws and is not for resale in any manner.



# FDD3510H

## Dual N & P-Channel PowerTrench<sup>®</sup> MOSFET

N-Channel: 80V, 13.9A, 80mΩ P-Channel: -80V, -9.4A, 190mΩ

### Features

Q1: N-Channel

- Max  $r_{DS(on)}$  = 80mΩ at  $V_{GS} = 10V$ ,  $I_D = 4.3A$
- Max  $r_{DS(on)}$  = 88mΩ at  $V_{GS} = 6V$ ,  $I_D = 4.1A$

Q2: P-Channel

- Max  $r_{DS(on)}$  = 190mΩ at  $V_{GS} = -10V$ ,  $I_D = -2.8A$
- Max  $r_{DS(on)}$  = 224mΩ at  $V_{GS} = -4.5V$ ,  $I_D = -2.6A$
- 100% UIL Tested
- RoHS Compliant

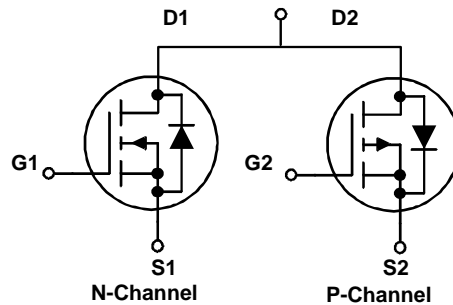
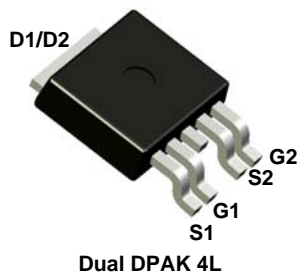


### General Description

These dual N and P-Channel enhancement mode Power MOSFETs are produced using Fairchild Semiconductor's advanced PowerTrench<sup>®</sup> process that has been especially tailored to minimize on-state resistance and yet maintain superior switching performance.

### Applications

- Inverter
- H-Bridge



### MOSFET Maximum Ratings $T_C = 25^\circ\text{C}$ unless otherwise noted

Symbol	Parameter	Q1	Q2	Units
$V_{DS}$	Drain to Source Voltage	80	-80	V
$V_{GS}$	Gate to Source Voltage	$\pm 20$	$\pm 20$	V
$I_D$	Drain Current - Continuous $T_C = 25^\circ\text{C}$	13.9	-9.4	A
	- Continuous $T_A = 25^\circ\text{C}$	4.3	-2.8	
	- Pulsed	20	-10	
$P_D$	Power Dissipation for Single Operation $T_C = 25^\circ\text{C}$ (Note 1)	35	32	W
	$T_A = 25^\circ\text{C}$ (Note 1a)	3.1		
	$T_A = 25^\circ\text{C}$ (Note 1b)	1.3		
$E_{AS}$	Single Pulse Avalanche Energy (Note 3)	37	54	mJ
$T_J, T_{STG}$	Operating and Storage Junction Temperature Range	-55 to +150		$^\circ\text{C}$

### Thermal Characteristics

$R_{\theta JC}$	Thermal Resistance, Junction to Case, Single Operation for Q1 (Note 1)	3.5	$^\circ\text{C/W}$
$R_{\theta JC}$	Thermal Resistance, Junction to Case, Single Operation for Q2 (Note 1)	3.9	

### Package Marking and Ordering Information

Device Marking	Device	Package	Reel Size	Tape Width	Quantity
FDD3510H	FDD3510H	TO-252-4L	13"	16mm	2500 units

FDD3510H Dual N & P-Channel PowerTrench<sup>®</sup> MOSFET

### Electrical Characteristics $T_J = 25^\circ\text{C}$ unless otherwise noted

Symbol	Parameter	Test Conditions	Type	Min	Typ	Max	Units
--------	-----------	-----------------	------	-----	-----	-----	-------

#### Off Characteristics

$BV_{DSS}$	Drain to Source Breakdown Voltage	$I_D = 250\mu\text{A}, V_{GS} = 0\text{V}$ $I_D = -250\mu\text{A}, V_{GS} = 0\text{V}$	Q1 Q2	80 -80			V
$\frac{\Delta BV_{DSS}}{\Delta T_J}$	Breakdown Voltage Temperature Coefficient	$I_D = 250\mu\text{A}$ , referenced to $25^\circ\text{C}$ $I_D = -250\mu\text{A}$ , referenced to $25^\circ\text{C}$	Q1 Q2		84 -67	mV	$^\circ\text{C}$
$I_{DSS}$	Zero Gate Voltage Drain Current	$V_{DS} = 64\text{V}, V_{GS} = 0\text{V}$ $V_{DS} = -64\text{V}, V_{GS} = 0\text{V}$	Q1 Q2			1 -1	$\mu\text{A}$
$I_{GSS}$	Gate to Source Leakage Current	$V_{GS} = \pm 20\text{V}, V_{DS} = 0\text{V}$	Q1 Q2			$\pm 100$ $\pm 100$	nA nA

#### On Characteristics

$V_{GS(th)}$	Gate to Source Threshold Voltage	$V_{GS} = V_{DS}, I_D = 250\mu\text{A}$ $V_{GS} = V_{DS}, I_D = -250\mu\text{A}$	Q1 Q2	2.0 -1.0	2.6 -1.6	4.0 -3.0	V
$\frac{\Delta V_{GS(th)}}{\Delta T_J}$	Gate to Source Threshold Voltage Temperature Coefficient	$I_D = 250\mu\text{A}$ , referenced to $25^\circ\text{C}$ $I_D = -250\mu\text{A}$ , referenced to $25^\circ\text{C}$	Q1 Q2		-6.7 4.6	mV	$^\circ\text{C}$
$r_{DS(on)}$	Static Drain to Source On Resistance	$V_{GS} = 10\text{V}, I_D = 4.3\text{A}$ $V_{GS} = 6.0\text{V}, I_D = 4.1\text{A}$ $V_{GS} = 10\text{V}, I_D = 4.3\text{A}, T_J = 125^\circ\text{C}$	Q1		64 70 121	80 88 152	m $\Omega$
		$V_{GS} = -10\text{V}, I_D = -2.8\text{A}$ $V_{GS} = -4.5\text{V}, I_D = -2.6\text{A}$ $V_{GS} = -10\text{V}, I_D = -2.8\text{A}, T_J = 125^\circ\text{C}$	Q2		153 184 259	190 224 322	
$g_{FS}$	Forward Transconductance	$V_{DD} = 10\text{V}, I_D = 4.3\text{A}$ $V_{DD} = -5\text{V}, I_D = -2.8\text{A}$	Q1 Q2		15 6.8		S

#### Dynamic Characteristics

$C_{iss}$	Input Capacitance	Q1 $V_{DS} = 40\text{V}, V_{GS} = 0\text{V}, f = 1\text{MHz}$	Q1 Q2		600 660	800 880	pF
$C_{oss}$	Output Capacitance	Q2	Q1 Q2		56 50	75 70	pF
$C_{rss}$	Reverse Transfer Capacitance	$V_{DS} = -40\text{V}, V_{GS} = 0\text{V}, f = 1\text{MHz}$	Q1 Q2		27 25	41 40	pF
$R_g$	Gate Resistance	$f = 1\text{MHz}$	Q1 Q2		1.7 7.2		$\Omega$

#### Switching Characteristics

$t_{d(on)}$	Turn-On Delay Time	Q1	Q1 Q2		7 6	13 11	ns
$t_r$	Rise Time	$V_{DD} = 40\text{V}, I_D = 4.3\text{A},$ $V_{GS} = 10\text{V}, R_{GEN} = 6\Omega$	Q1		2	10	ns
			Q2		3	10	
$t_{d(off)}$	Turn-Off Delay Time	Q2 $V_{DD} = -40\text{V}, I_D = -2.8\text{A},$ $V_{GS} = -10\text{V}, R_{GEN} = 6\Omega$	Q1		16	29	ns
			Q2		25	40	
$t_f$	Fall Time	$V_{GS} = -10\text{V}, R_{GEN} = 6\Omega$	Q1		2	10	ns
			Q2		5	10	
$Q_{g(TOT)}$	Total Gate Charge	Q1 $V_{GS} = 10\text{V}, V_{DD} = 40\text{V}, I_D = 4.3\text{A}$	Q1		13	18	nC
			Q2		14	20	
$Q_{gs}$	Gate to Source Charge	Q2	Q1		2.3		nC
			Q2		1.9		
$Q_{gd}$	Gate to Drain "Miller" Charge	$V_{GS} = -10\text{V}, V_{DD} = -40\text{V}, I_D = -2.8\text{A}$	Q1		3.2		nC
			Q2		2.9		

## Electrical Characteristics $T_J = 25^\circ\text{C}$ unless otherwise noted

Symbol	Parameter	Test Conditions	Type	Min	Typ	Max	Units
--------	-----------	-----------------	------	-----	-----	-----	-------

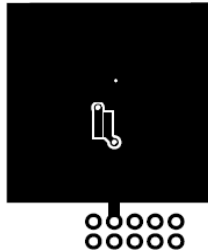
### Drain-Source Diode Characteristics

$V_{SD}$	Source to Drain Diode Forward Voltage	$V_{GS} = 0V, I_S = 2.6A$ (Note 2) $V_{GS} = 0V, I_S = -2.6A$ (Note 2)	Q1 Q2		0.8 -0.8	1.2 -1.2	V
$t_{rr}$	Reverse Recovery Time	Q1 $I_F = 4.3A, di/dt = 100A/s$	Q1 Q2		29 30	46 48	ns
$Q_{rr}$	Reverse Recovery Charge	Q2 $I_F = -2.8A, di/dt = 100A/s$	Q1 Q2		28 30	45 48	nC

#### Notes:

- $R_{\theta JA}$  is determined with the device mounted on a  $1\text{in}^2$  pad 2 oz copper pad on a  $1.5 \times 1.5$  in. board of FR-4 material.  $R_{\theta JC}$  is guaranteed by design while  $R_{\theta CA}$  is determined by the user's board design.

Q1



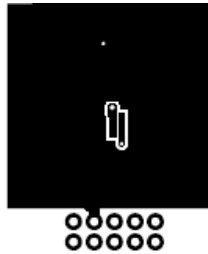
a.  $40^\circ\text{C/W}$  when mounted on a  $1\text{in}^2$  pad of 2 oz copper

Scale 1 : 1 on letter size paper



b.  $96^\circ\text{C/W}$  when mounted on a minimum pad of 2 oz copper

Q2



a.  $40^\circ\text{C/W}$  when mounted on a  $1\text{in}^2$  pad of 2 oz copper

Scale 1 : 1 on letter size paper

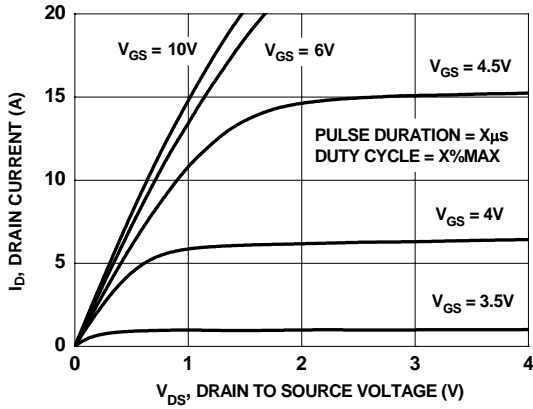


b.  $96^\circ\text{C/W}$  when mounted on a minimum pad of 2 oz copper

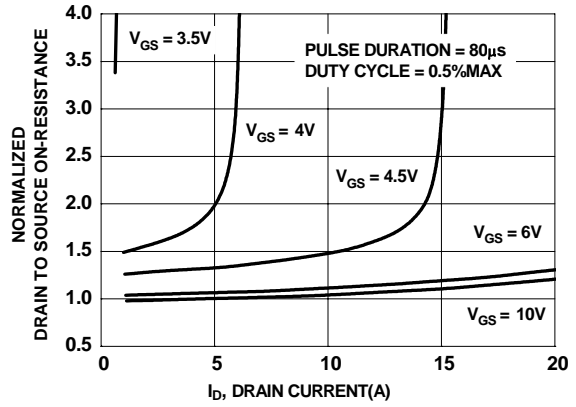
- Pulse Test: Pulse Width  $< 300\mu\text{s}$ , Duty cycle  $< 2.0\%$ .

- Starting  $T_J = 25^\circ\text{C}$ , N-ch:  $L = 3\text{mH}, I_{AS} = 5A, V_{DD} = 80V, V_{GS} = 10V$ ; P-ch:  $L = 3\text{mH}, I_{AS} = -6A, V_{DD} = -80V, V_{GS} = -10V$ .

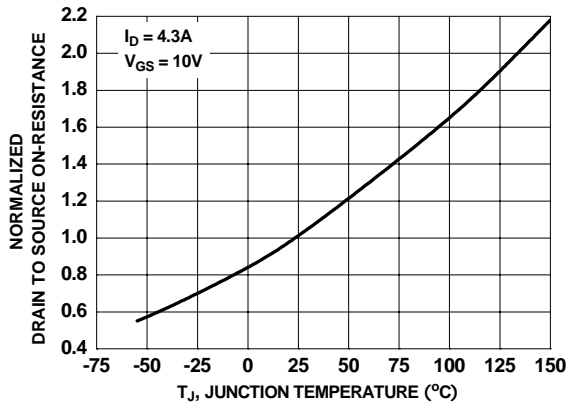
**Typical Characteristics (Q1 N-Channel)**  $T_J = 25^\circ\text{C}$  unless otherwise noted



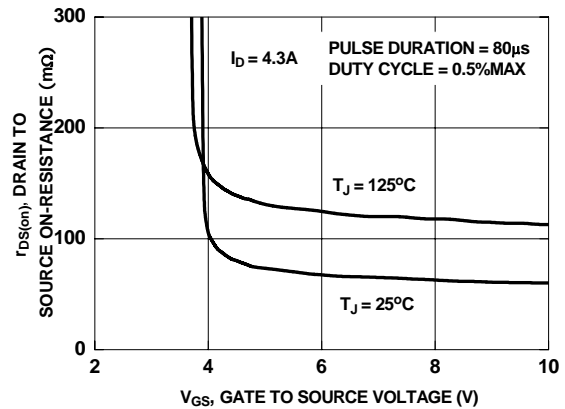
**Figure 1. On Region Characteristics**



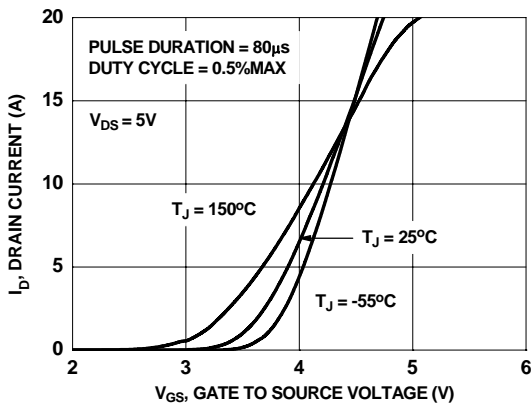
**Figure 2. Normalized On-Resistance vs Drain Current and Gate Voltage**



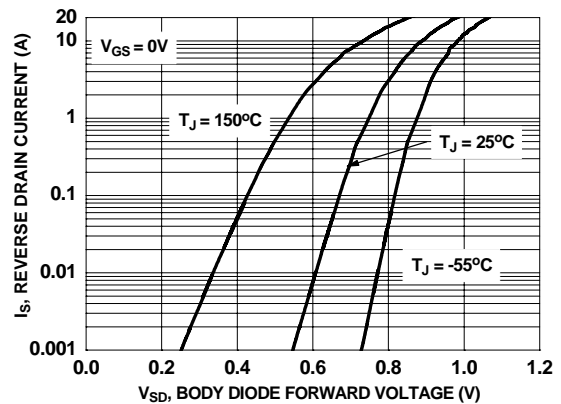
**Figure 3. Normalized On Resistance vs Junction Temperature**



**Figure 4. On-Resistance vs Gate to Source Voltage**

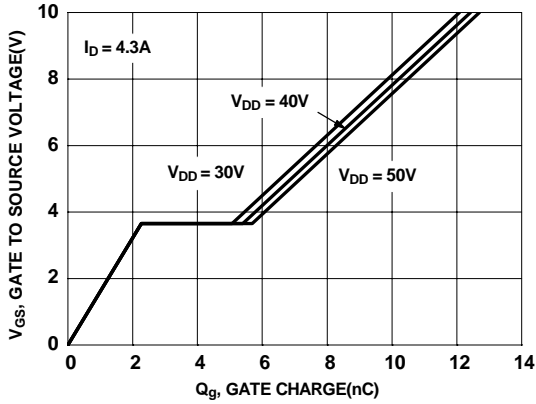


**Figure 5. Transfer Characteristics**

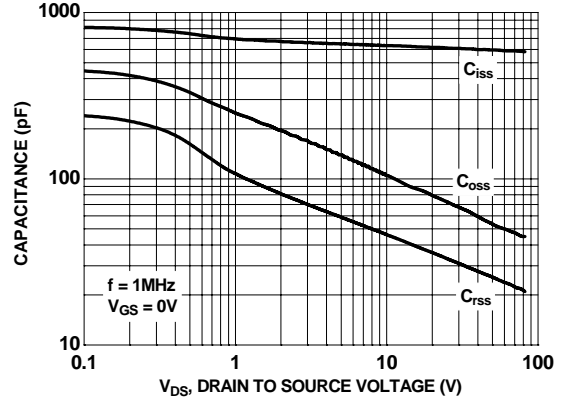


**Figure 6. Source to Drain Diode Forward Voltage vs Source Current**

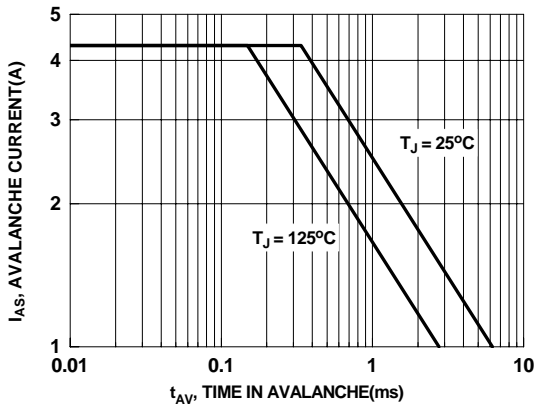
**Typical Characteristics (Q1 N-Channel)**  $T_J = 25^\circ\text{C}$  unless otherwise noted



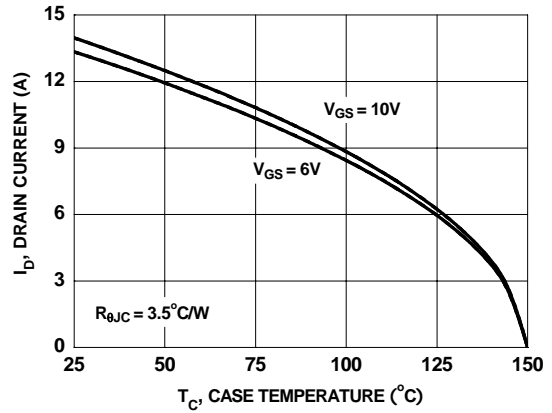
**Figure 7. Gate Charge Characteristics**



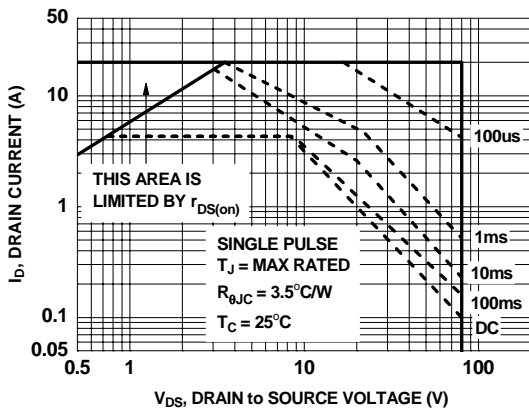
**Figure 8. Capacitance vs Drain to Source Voltage**



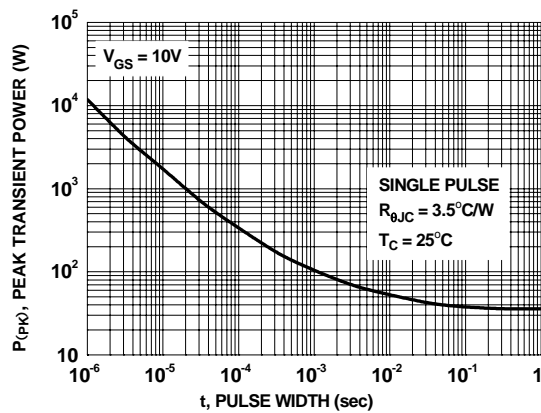
**Figure 9. Unclamped Inductive Switching Capability**



**Figure 10. Maximum Continuous Drain Current vs Case Temperature**

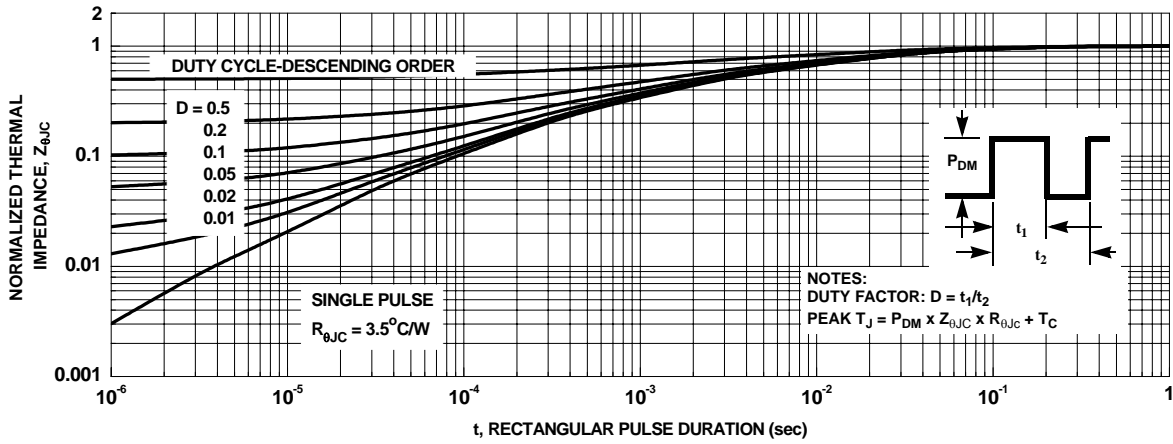


**Figure 11. Forward Bias Safe Operating Area**

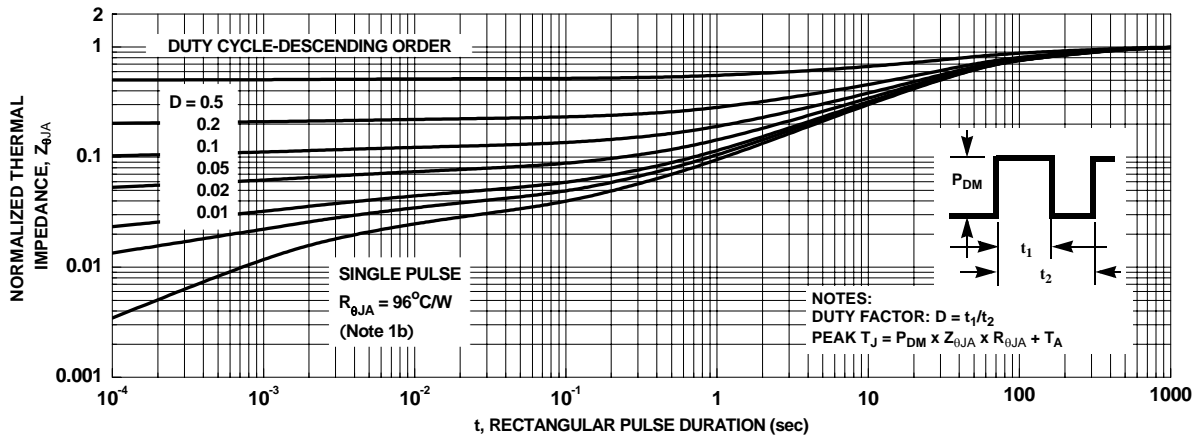


**Figure 12. Single Pulse Maximum Power Dissipation**

**Typical Characteristics (Q1 N-Channel)**  $T_J = 25^\circ\text{C}$  unless otherwise noted



**Figure 13. Transient Thermal Response Curve**



**Figure 14. Transient Thermal Response Curve**

**Typical Characteristics (Q2 P-Channel)**  $T_J = 25^\circ\text{C}$  unless otherwise noted

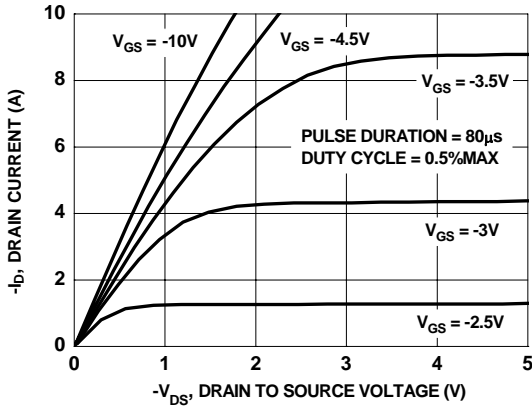


Figure 15. On-Region Characteristics

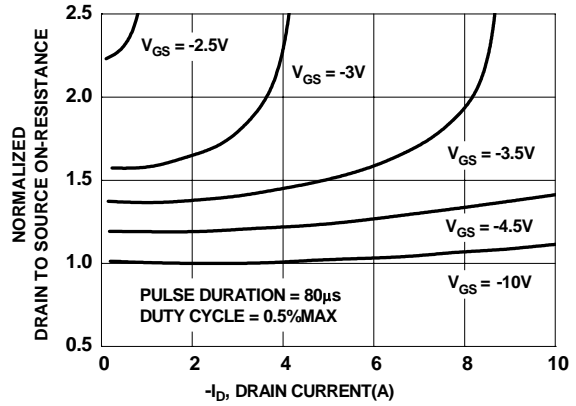


Figure 16. Normalized on-Resistance vs Drain Current and Gate Voltage

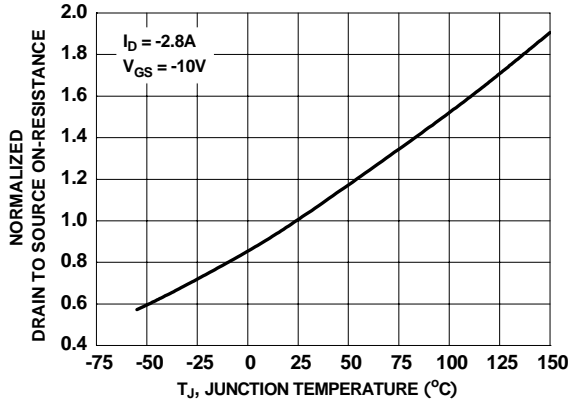


Figure 17. Normalized On-Resistance vs Junction Temperature

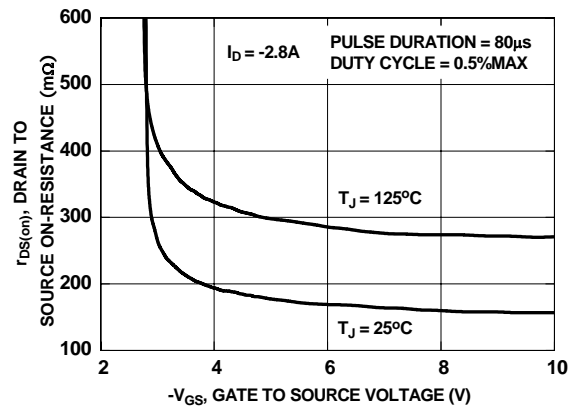


Figure 18. On-Resistance vs Gate to Source Voltage

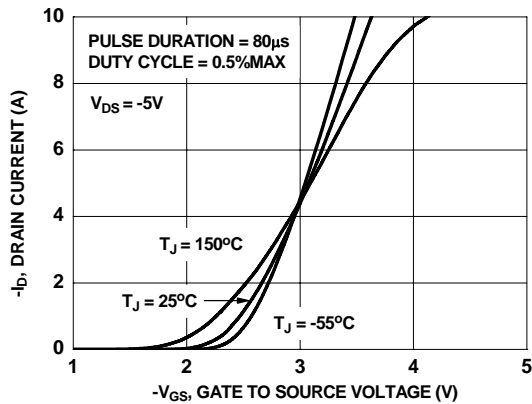


Figure 19. Transfer Characteristics

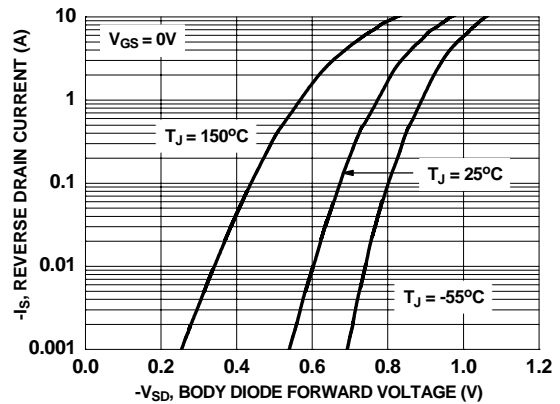
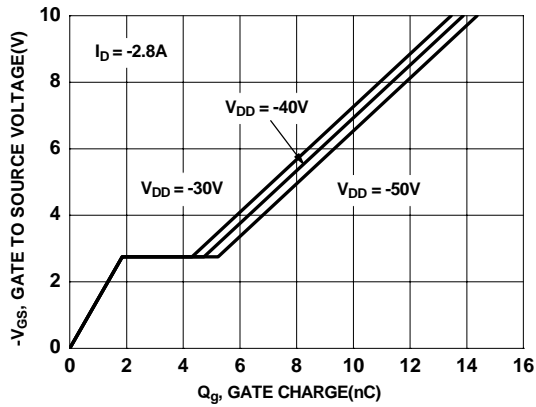


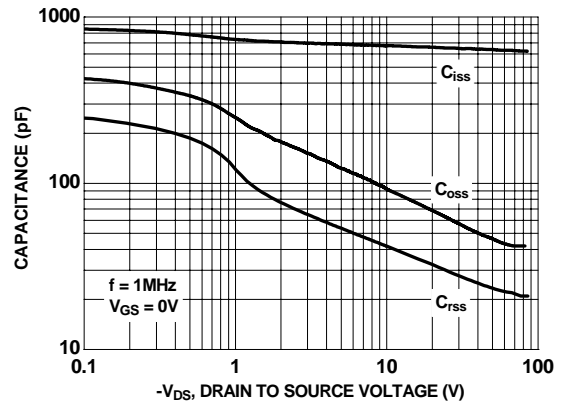
Figure 20. Source to Drain Diode Forward Voltage vs Source Current



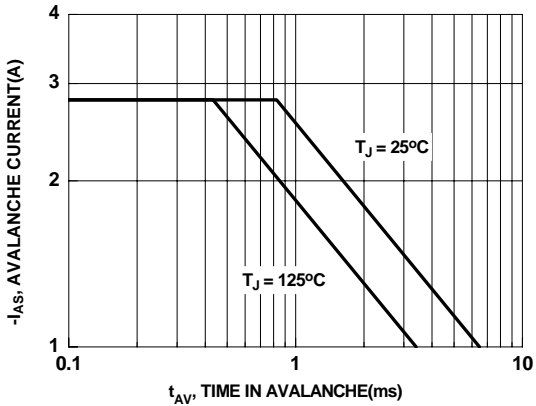
**Typical Characteristics (Q2 P-Channel)**  $T_J = 25^\circ\text{C}$  unless otherwise noted



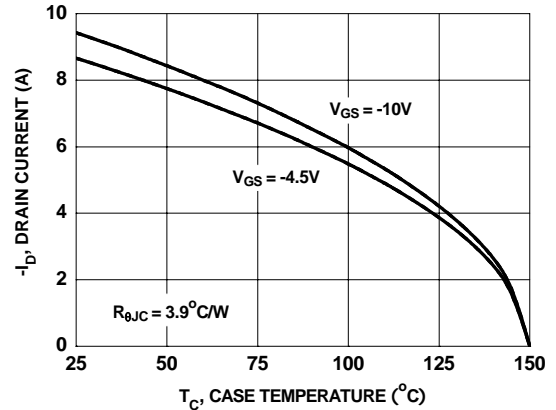
**Figure 21. Gate Charge Characteristics**



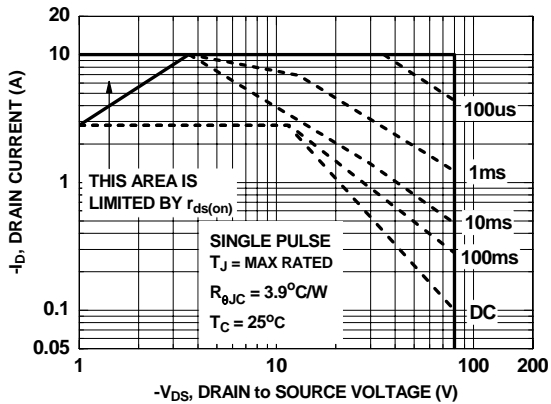
**Figure 22. Capacitance vs Drain to Source Voltage**



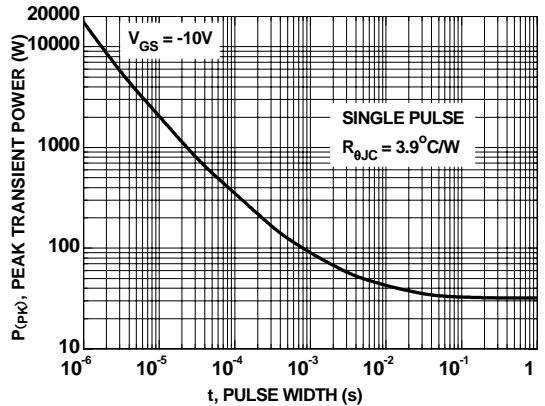
**Figure 23. Unclamped Inductive Switching Capability**



**Figure 24. Maximum Continuous Drain Current vs Case Temperature**

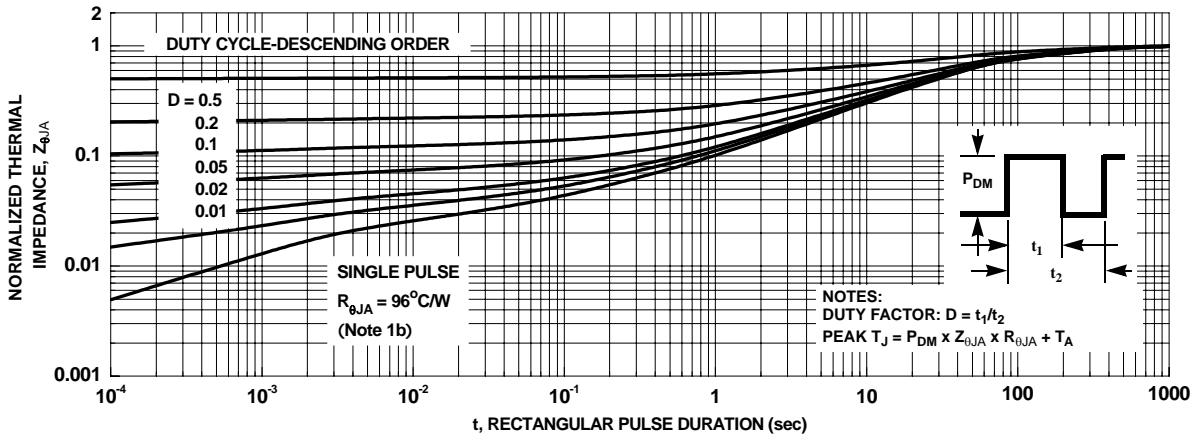
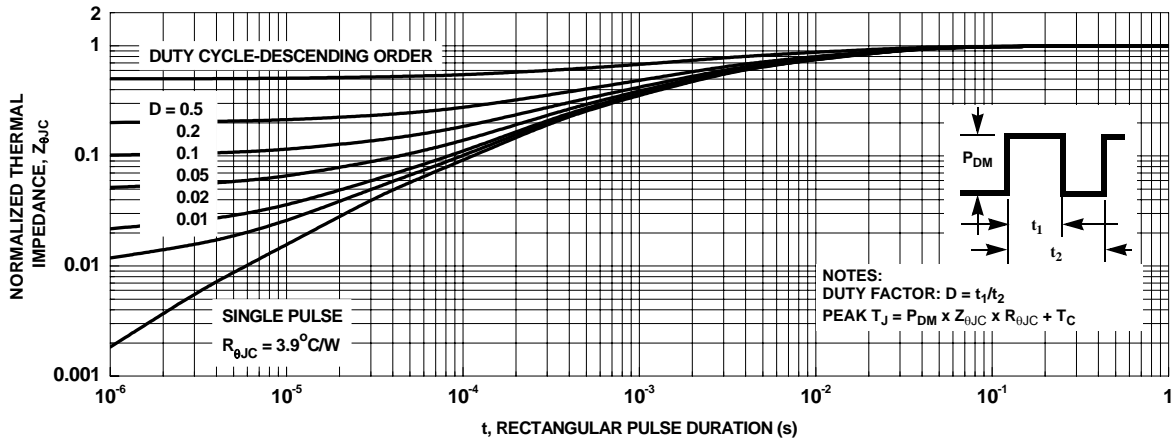


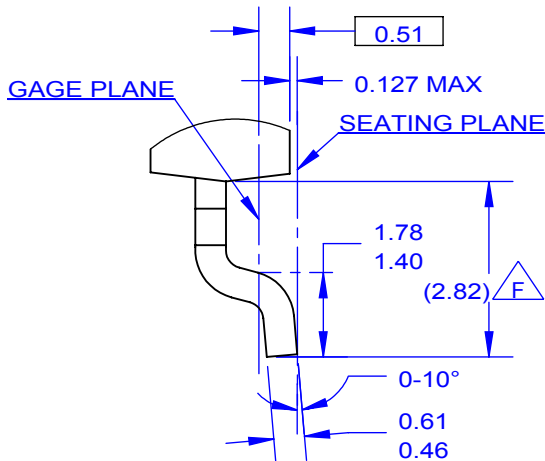
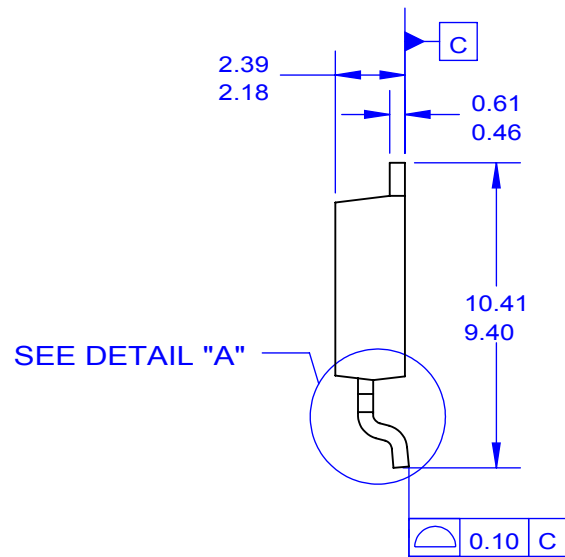
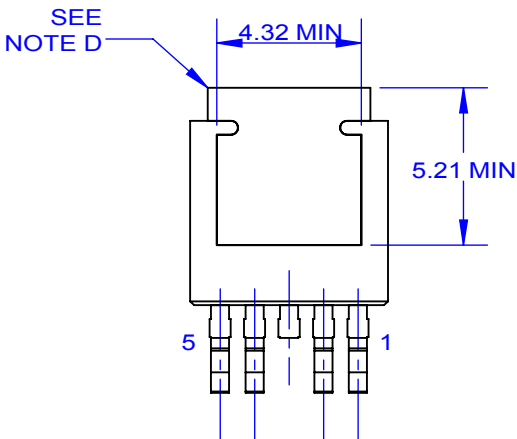
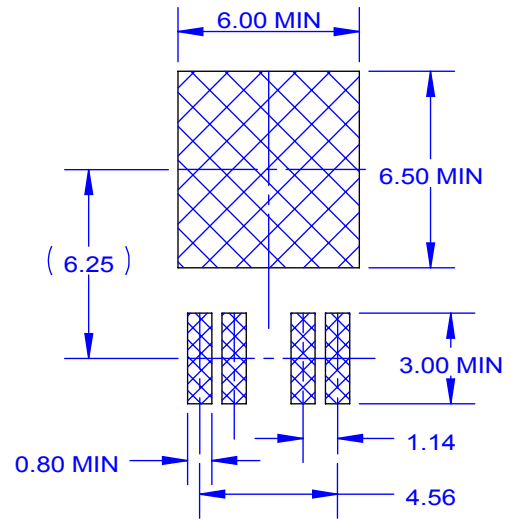
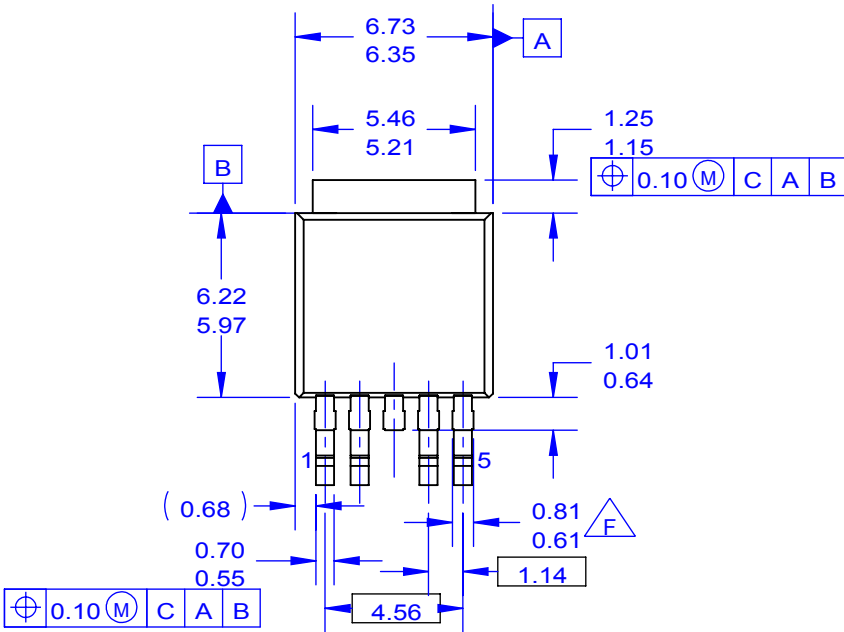
**Figure 25. Forward Bias Safe Operating Area**



**Figure 26. Single Pulse Maximum Power Dissipation**

**Typical Characteristics (Q2 P-Channel)**  $T_J = 25^\circ\text{C}$  unless otherwise noted





DETAIL A  
SCALE 2:1

NOTES: UNLESS OTHERWISE SPECIFIED

- A. THIS PACKAGE CONFORMS TO JEDEC, TO252 VARIATION AD.
- B. ALL DIMENSIONS ARE IN MILLIMETERS.
- C. DIMENSIONS ARE EXCLUSIVE OF BURRS, MOLD FLASH AND TIE BAR PROTRUSIONS
- D. HEATSINK TOP EDGE COULD BE IN CHAMFERED CORNERS OR EDGE PROTRUSION.
- E. DIMENSIONS AND TOLERANCES AS PER ASME Y14.5-2009.
- F. EXCEPTION TO TO-252 STANDARD.
- G. FILE NAME: TO252B05REV3
- H. FAIRCHILDSEMICONDUCTOR

ON Semiconductor and  are trademarks of Semiconductor Components Industries, LLC dba ON Semiconductor or its subsidiaries in the United States and/or other countries. ON Semiconductor owns the rights to a number of patents, trademarks, copyrights, trade secrets, and other intellectual property. A listing of ON Semiconductor's product/patent coverage may be accessed at [www.onsemi.com/site/pdf/Patent-Marking.pdf](http://www.onsemi.com/site/pdf/Patent-Marking.pdf). ON Semiconductor reserves the right to make changes without further notice to any products herein. ON Semiconductor makes no warranty, representation or guarantee regarding the suitability of its products for any particular purpose, nor does ON Semiconductor assume any liability arising out of the application or use of any product or circuit, and specifically disclaims any and all liability, including without limitation special, consequential or incidental damages. Buyer is responsible for its products and applications using ON Semiconductor products, including compliance with all laws, regulations and safety requirements or standards, regardless of any support or applications information provided by ON Semiconductor. "Typical" parameters which may be provided in ON Semiconductor data sheets and/or specifications can and do vary in different applications and actual performance may vary over time. All operating parameters, including "Typicals" must be validated for each customer application by customer's technical experts. ON Semiconductor does not convey any license under its patent rights nor the rights of others. ON Semiconductor products are not designed, intended, or authorized for use as a critical component in life support systems or any FDA Class 3 medical devices or medical devices with a same or similar classification in a foreign jurisdiction or any devices intended for implantation in the human body. Should Buyer purchase or use ON Semiconductor products for any such unintended or unauthorized application, Buyer shall indemnify and hold ON Semiconductor and its officers, employees, subsidiaries, affiliates, and distributors harmless against all claims, costs, damages, and expenses, and reasonable attorney fees arising out of, directly or indirectly, any claim of personal injury or death associated with such unintended or unauthorized use, even if such claim alleges that ON Semiconductor was negligent regarding the design or manufacture of the part. ON Semiconductor is an Equal Opportunity/Affirmative Action Employer. This literature is subject to all applicable copyright laws and is not for resale in any manner.

## PUBLICATION ORDERING INFORMATION

### LITERATURE FULFILLMENT:

Literature Distribution Center for ON Semiconductor  
19521 E. 32nd Pkwy, Aurora, Colorado 80011 USA  
**Phone:** 303-675-2175 or 800-344-3860 Toll Free USA/Canada  
**Fax:** 303-675-2176 or 800-344-3867 Toll Free USA/Canada  
**Email:** [orderlit@onsemi.com](mailto:orderlit@onsemi.com)

**N. American Technical Support:** 800-282-9855 Toll Free  
USA/Canada  
**Europe, Middle East and Africa Technical Support:**  
Phone: 421 33 790 2910  
**Japan Customer Focus Center**  
Phone: 81-3-5817-1050

**ON Semiconductor Website:** [www.onsemi.com](http://www.onsemi.com)  
**Order Literature:** <http://www.onsemi.com/orderlit>  
For additional information, please contact your local  
Sales Representative

# Mouser Electronics

Authorized Distributor

Click to View Pricing, Inventory, Delivery & Lifecycle Information:

[ON Semiconductor:](#)

[FDD3510H](#)



Компания «ЭлектроПласт» предлагает заключение долгосрочных отношений при поставках импортных электронных компонентов на взаимовыгодных условиях!

Наши преимущества:

- Оперативные поставки широкого спектра электронных компонентов отечественного и импортного производства напрямую от производителей и с крупнейших мировых складов;
- Поставка более 17-ти миллионов наименований электронных компонентов;
- Поставка сложных, дефицитных, либо снятых с производства позиций;
- Оперативные сроки поставки под заказ (от 5 рабочих дней);
- Экспресс доставка в любую точку России;
- Техническая поддержка проекта, помощь в подборе аналогов, поставка прототипов;
- Система менеджмента качества сертифицирована по Международному стандарту ISO 9001;
- Лицензия ФСБ на осуществление работ с использованием сведений, составляющих государственную тайну;
- Поставка специализированных компонентов (Xilinx, Altera, Analog Devices, Intersil, Interpoint, Microsemi, Aeroflex, Peregrine, Syfer, Eurofarad, Texas Instrument, Miteq, Cobham, E2V, MA-COM, Hittite, Mini-Circuits, General Dynamics и др.);

Помимо этого, одним из направлений компании «ЭлектроПласт» является направление «Источники питания». Мы предлагаем Вам помощь Конструкторского отдела:

- Подбор оптимального решения, техническое обоснование при выборе компонента;
- Подбор аналогов;
- Консультации по применению компонента;
- Поставка образцов и прототипов;
- Техническая поддержка проекта;
- Защита от снятия компонента с производства.



#### Как с нами связаться

**Телефон:** 8 (812) 309 58 32 (многоканальный)

**Факс:** 8 (812) 320-02-42

**Электронная почта:** [org@eplast1.ru](mailto:org@eplast1.ru)

**Адрес:** 198099, г. Санкт-Петербург, ул. Калинина, дом 2, корпус 4, литера А.