

# 10MHz, 6V/ $\mu$ s, Dual/Quad Rail-to-Rail Input and Output Precision C-Load Op Amps

## FEATURES

- Rail-to-Rail Input and Output
- 475 $\mu$ V Max  $V_{OS}$  from  $V^+$  to  $V^-$
- Gain-Bandwidth Product: 10MHz
- Slew Rate: 6V/ $\mu$ s
- Low Supply Current per Amplifier: 1.7mA
- Input Offset Current: 65nA Max
- Input Bias Current: 650nA Max
- Open-Loop Gain: 1000V/mV Min
- Low Input Noise Voltage: 12nV/ $\sqrt{\text{Hz}}$  Typ
- Wide Supply Range: 2.2V to  $\pm 15$ V
- Large Output Drive Current: 30mA
- Stable for Capacitive Loads Up to 10,000pF
- Dual in 8-Pin PDIP and SO Package
- Quad in Narrow 14-Pin SO

## APPLICATIONS

- Driving A-to-D Converters
- Active Filters
- Rail-to-Rail Buffer Amplifiers
- Low Voltage Signal Processing
- Battery-Powered Systems

LT, LT, LTC, LTM, Linear Technology and the Linear logo are registered trademarks and C-Load is a trademark of Linear Technology Corporation. All other trademarks are the property of their respective owners.

## DESCRIPTION

The LT<sup>®</sup>1498/LT1499 are dual/quad, rail-to-rail input and output precision C-Load<sup>™</sup> op amps with a 10MHz gain-bandwidth product and a 6V/ $\mu$ s slew rate.

The LT1498/LT1499 are designed to maximize input dynamic range by delivering precision performance over the full supply voltage. Using a patented technique, both input stages of the LT1498/LT1499 are trimmed, one at the negative supply and the other at the positive supply. The resulting guaranteed common mode rejection is much better than other rail-to-rail input op amps. When used as a unity-gain buffer in front of single supply 12-bit A-to-D converters, the LT1498/LT1499 are guaranteed to add less than 1LSB of error even in single 3V supply systems.

With 110dB of supply rejection, the LT1498/LT1499 maintain their performance over a supply range of 2.2V to 36V and are specified for 3V, 5V and  $\pm 15$ V supplies. The inputs can be driven beyond the supplies without damage or phase reversal of the output. These op amps remain stable while driving capacitive loads up to 10,000pF.

The LT1498 is available with the standard dual op amp configuration in 8-pin PDIP and SO packaging. The LT1499 features the standard quad op amp configuration and is available in a 14-pin plastic SO package. These devices can be used as plug-in replacements for many standard op amps to improve input/output range and precision.

## TYPICAL APPLICATION

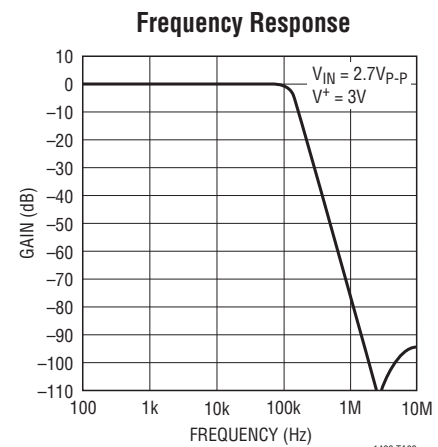

# LT1498/LT1499

## ABSOLUTE MAXIMUM RATINGS (Note 1)

Total Supply Voltage ( $V^+$ to $V^-$ ).....	36V	Specified Temperature Range (Note 4)	
Input Current.....	$\pm 10\text{mA}$	LT1498/LT1499.....	$-40^\circ\text{C}$ to $85^\circ\text{C}$
Output Short-Circuit Duration (Note 2).....	Continuous	LT1498H/LT1499H.....	$-40^\circ\text{C}$ to $125^\circ\text{C}$
Operating Temperature Range		LT1498MP.....	$-55^\circ\text{C}$ to $125^\circ\text{C}$
LT1498/LT1499.....	$-40^\circ\text{C}$ to $85^\circ\text{C}$	Junction Temperature.....	$150^\circ\text{C}$
LT1498H/LT1499H.....	$-40^\circ\text{C}$ to $125^\circ\text{C}$	Storage Temperature Range.....	$-65^\circ\text{C}$ to $150^\circ\text{C}$
LT1498MP.....	$-55^\circ\text{C}$ to $125^\circ\text{C}$	Lead Temperature (Soldering, 10 sec).....	$300^\circ\text{C}$

## PIN CONFIGURATION

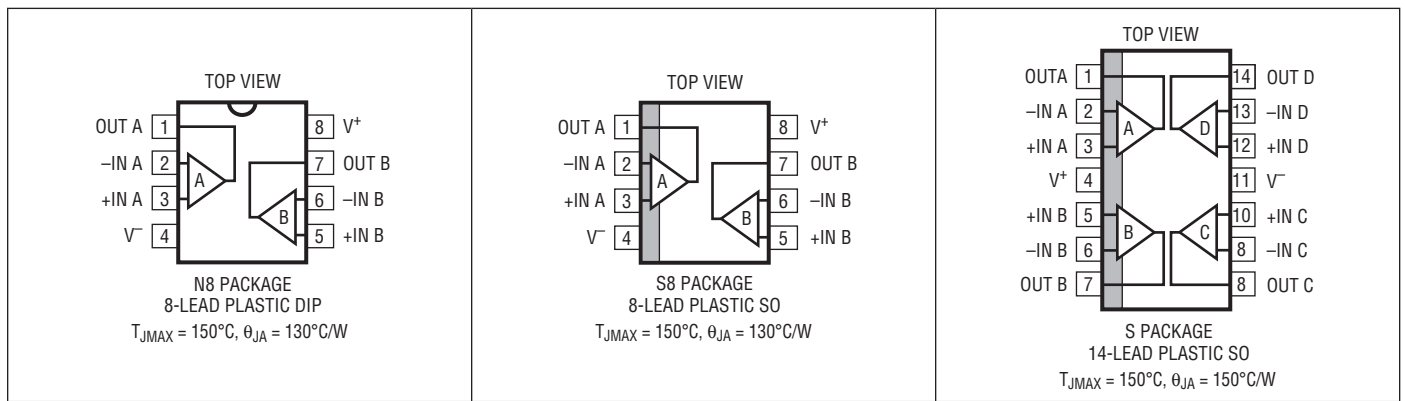

## ORDER INFORMATION

LEAD FREE FINISH	TAPE AND REEL	PART MARKING*	PACKAGE DESCRIPTION	SPECIFIED TEMPERATURE RANGE
LT1498CN8#PBF	LT1498CN8#TRPBF	LT1498CN8	8-Lead Plastic PDIP	$0^\circ\text{C}$ to $70^\circ\text{C}$
LT1498CS8#PBF	LT1498CS8#TRPBF	1498	8-Lead Plastic SO	$0^\circ\text{C}$ to $70^\circ\text{C}$
LT1498IN8#PBF	LT1498IN8#TRPBF	LT1498IN8	8-Lead Plastic PDIP	$-40^\circ\text{C}$ to $85^\circ\text{C}$
LT1498IS8#PBF	LT1498IS8#TRPBF	1498I	8-Lead Plastic SO	$-40^\circ\text{C}$ to $85^\circ\text{C}$
LT1498HS8#PBF	LT1498HS8#TRPBF	1498H	8-Lead Plastic SO	$-40^\circ\text{C}$ to $125^\circ\text{C}$
LT1498MPS8#PBF	LT1498MPS8#TRPBF	1498MP	8-Lead Plastic SO	$-55^\circ\text{C}$ to $125^\circ\text{C}$
LT1499CS#PBF	LT1499CS#TRPBF	LT1499CS	14-Lead Plastic SO	$0^\circ\text{C}$ to $70^\circ\text{C}$
LT1499IS#PBF	LT1499IS#TRPBF	LT1499IS	14-Lead Plastic SO	$-40^\circ\text{C}$ to $85^\circ\text{C}$
LT1499HS#PBF	LT1499HS#TRPBF	LT1499HS	14-Lead Plastic SO	$-40^\circ\text{C}$ to $125^\circ\text{C}$

Consult LTC Marketing for parts specified with wider operating temperature ranges. \*The temperature grade is identified by a label on the shipping container. Consult LTC Marketing for information on non-standard lead based finish parts.

For more information on lead free part marking, go to: <http://www.linear.com/leadfree/>  
For more information on tape and reel specifications, go to: <http://www.linear.com/tapeandree/>

**ELECTRICAL CHARACTERISTICS**  $T_A = 25^\circ\text{C}$ ,  $V_S = 5\text{V}$ ,  $0\text{V}$ ;  $V_S = 3\text{V}$ ,  $0\text{V}$ ;  $V_{CM} = V_{OUT} = \text{half supply}$ , unless otherwise noted.

SYMBOL	PARAMETER	CONDITIONS	MIN	TYP	MAX	UNITS
$V_{OS}$	Input Offset Voltage	$V_{CM} = V^+$		150	475	$\mu\text{V}$
		$V_{CM} = V^-$		150	475	$\mu\text{V}$
$\Delta V_{OS}$	Input Offset Voltage Shift	$V_{CM} = V^- \text{ to } V^+$		150	425	$\mu\text{V}$
	Input Offset Voltage Match (Channel-to-Channel)	$V_{CM} = V^+, V^-$ (Note 5)		200	750	$\mu\text{V}$
$I_B$	Input Bias Current	$V_{CM} = V^+$	0	250	650	nA
		$V_{CM} = V^-$	-650	-250	0	nA
$\Delta I_B$	Input Bias Current Shift	$V_{CM} = V^- \text{ to } V^+$		500	1300	nA
	Input Bias Current Match (Channel-to-Channel)	$V_{CM} = V^+$ (Note 5) $V_{CM} = V^-$ (Note 5)	0 -100	10 -10	100 0	nA nA
$I_{OS}$	Input Offset Current	$V_{CM} = V^+$		5	65	nA
		$V_{CM} = V^-$		5	65	nA
$\Delta I_{OS}$	Input Offset Current Shift	$V_{CM} = V^- \text{ to } V^+$		10	130	nA
	Input Noise Voltage	0.1Hz to 10Hz		400		nV <sub>p-p</sub>
$e_n$	Input Noise Voltage Density	$f = 1\text{kHz}$		12		nV/ $\sqrt{\text{Hz}}$
$i_n$	Input Noise Current Density	$f = 1\text{kHz}$		0.3		pA/ $\sqrt{\text{Hz}}$
$C_{IN}$	Input Capacitance			5		pF
$A_{VOL}$	Large-Signal Voltage Gain	$V_S = 5\text{V}$ , $V_O = 75\text{mV to } 4.8\text{V}$ , $R_L = 10\text{k}$	600	3800		V/mV
		$V_S = 3\text{V}$ , $V_O = 75\text{mV to } 2.8\text{V}$ , $R_L = 10\text{k}$	500	2000		V/mV
CMRR	Common Mode Rejection Ratio	$V_S = 5\text{V}$ , $V_{CM} = V^- \text{ to } V^+$	81	90		dB
		$V_S = 3\text{V}$ , $V_{CM} = V^- \text{ to } V^+$	76	86		dB
		CMRR Match (Channel-to-Channel) (Note 5)	$V_S = 5\text{V}$ , $V_{CM} = V^- \text{ to } V^+$ $V_S = 3\text{V}$ , $V_{CM} = V^- \text{ to } V^+$	75 70	91 86	
PSRR	Power Supply Rejection Ratio	$V_S = 2.2\text{V to } 12\text{V}$ , $V_{CM} = V_O = 0.5\text{V}$	88	105		dB
	PSRR Match (Channel-to-Channel) (Note 5)	$V_S = 2.2\text{V to } 12\text{V}$ , $V_{CM} = V_O = 0.5\text{V}$	82	103		dB
$V_{OL}$	Output Voltage Swing (Low) (Note 6)	No Load		14	30	mV
		$I_{SINK} = 0.5\text{mA}$		35	70	mV
		$I_{SINK} = 2.5\text{mA}$		90	200	mV
$V_{OH}$	Output Voltage Swing (High) (Note 6)	No Load		2.5	10	mV
		$I_{SOURCE} = 0.5\text{mA}$		50	100	mV
		$I_{SOURCE} = 2.5\text{mA}$		140	250	mV
$I_{SC}$	Short-Circuit Current	$V_S = 5\text{V}$	$\pm 12.5$	$\pm 24$		mA
		$V_S = 3\text{V}$	$\pm 12.0$	$\pm 19$		mA
$I_S$	Supply Current per Amplifier			1.7	2.2	mA
GBW	Gain-Bandwidth Product (Note 7)		6.8	10.5		MHz
SR	Slew Rate (Note 8)	$V_S = 5\text{V}$ , $A_V = -1$ , $R_L = \text{Open}$ , $V_O = 4\text{V}$	2.6	4.5		V/ $\mu\text{s}$
		$V_S = 3\text{V}$ , $A_V = -1$ , $R_L = \text{Open}$	2.3	4.0		V/ $\mu\text{s}$

## ELECTRICAL CHARACTERISTICS

The ● denotes the specifications which apply over the temperature range  $0^{\circ}\text{C} < T_A < 70^{\circ}\text{C}$ .  $V_S = 5\text{V}, 0\text{V}$ ;  $V_S = 3\text{V}, 0\text{V}$ ;  $V_{CM} = V_{OUT} = \text{half supply}$ , unless otherwise noted.

SYMBOL	PARAMETER	CONDITIONS	MIN	TYP	MAX	UNITS
$V_{OS}$	Input Offset Voltage	$V_{CM} = V^+$	●	175	650	$\mu\text{V}$
		$V_{CM} = V^- + 0.1\text{V}$	●	175	650	$\mu\text{V}$
$V_{OS\ TC}$	Input Offset Voltage Drift (Note 3)	$V_{CM} = V^+$	●	0.5	2.5	$\mu\text{V}/^{\circ}\text{C}$
		$V_{CM} = V^- + 0.1\text{V}$	●	1.5	4.0	$\mu\text{V}/^{\circ}\text{C}$
$\Delta V_{OS}$	Input Offset Voltage Shift	$V_{CM} = V^- + 0.1\text{V}$ to $V^+$	●	170	600	$\mu\text{V}$
	Input Offset Voltage Match (Channel-to-Channel)	$V_{CM} = V^- + 0.1\text{V}, V^+$ (Note 5)	●	200	900	$\mu\text{V}$
$I_B$	Input Bias Current	$V_{CM} = V^+$	●	0	275	nA
		$V_{CM} = V^- + 0.1\text{V}$	●	-780	-275	0
$\Delta I_B$	Input Bias Current Shift	$V_{CM} = V^- + 0.1\text{V}$ to $V^+$	●	550	1560	nA
	Input Bias Current Match (Channel-to-Channel)	$V_{CM} = V^+$ (Note 5) $V_{CM} = V^- + 0.1\text{V}$ (Note 5)	● ●	0 -170	15 -15	170 0
$I_{OS}$	Input Offset Current	$V_{CM} = V^+$	●	10	85	nA
		$V_{CM} = V^- + 0.1\text{V}$	●	10	85	nA
$\Delta I_{OS}$	Input Offset Current Shift	$V_{CM} = V^- + 0.1\text{V}$ to $V^+$	●	20	170	nA
$A_{VOL}$	Large-Signal Voltage Gain	$V_S = 5\text{V}, V_O = 75\text{mV}$ to $4.8\text{V}, R_L = 10\text{k}$	●	500	2500	V/mV
		$V_S = 3\text{V}, V_O = 75\text{mV}$ to $2.8\text{V}, R_L = 10\text{k}$	●	400	2000	V/mV
CMRR	Common Mode Rejection Ratio	$V_S = 5\text{V}, V_{CM} = V^- + 0.1\text{V}$ to $V^+$	●	78	89	dB
		$V_S = 3\text{V}, V_{CM} = V^- + 0.1\text{V}$ to $V^+$	●	73	85	dB
	CMRR Match (Channel-to-Channel) (Note 5)	$V_S = 5\text{V}, V_{CM} = V^- + 0.1\text{V}$ to $V^+$ $V_S = 3\text{V}, V_{CM} = V^- + 0.1\text{V}$ to $V^+$	● ●	74 69	90 86	dB dB
PSRR	Power Supply Rejection Ratio	$V_S = 2.3\text{V}$ to $12\text{V}, V_{CM} = V_O = 0.5\text{V}$	●	86	102	dB
	PSRR Match (Channel-to-Channel) (Note 5)	$V_S = 2.3\text{V}$ to $12\text{V}, V_{CM} = V_O = 0.5\text{V}$	●	80	102	dB
$V_{OL}$	Output Voltage Swing (Low) (Note 6)	No Load	●	17	35	mV
		$I_{SINK} = 0.5\text{mA}$	●	40	80	mV
		$I_{SINK} = 2.5\text{mA}$	●	110	220	mV
$V_{OH}$	Output Voltage Swing (High) (Note 6)	No Load	●	3.5	15	mV
		$I_{SOURCE} = 0.5\text{mA}$	●	55	120	mV
		$I_{SOURCE} = 2.5\text{mA}$	●	160	300	mV
$I_{SC}$	Short-Circuit Current	$V_S = 5\text{V}$	●	$\pm 12$	$\pm 23$	mA
		$V_S = 3\text{V}$	●	$\pm 10$	$\pm 20$	mA
$I_S$	Supply Current per Amplifier		●	1.9	2.6	mA
GBW	Gain-Bandwidth Product (Note 7)		●	6.1	9	MHz
SR	Slew Rate (Note 8)	$V_S = 5\text{V}, A_V = -1, R_L = \text{Open}, V_O = 4\text{V}$	●	2.5	4.0	V/ $\mu\text{s}$
		$V_S = 3\text{V}, A_V = -1, R_L = \text{Open}$	●	2.2	3.5	V/ $\mu\text{s}$

**ELECTRICAL CHARACTERISTICS** The ● denotes the specifications which apply over the temperature range  $-40^{\circ}\text{C} < T_A < 85^{\circ}\text{C}$ .  $V_S = 5\text{V}, 0\text{V}$ ;  $V_S = 3\text{V}, 0\text{V}$ ;  $V_{\text{CM}} = V_{\text{OUT}} = \text{half supply}$ , unless otherwise noted. (Note 4)

SYMBOL	PARAMETER	CONDITIONS	MIN	TYP	MAX	UNITS
$V_{\text{OS}}$	Input Offset Voltage	$V_{\text{CM}} = V^+$	●	250	750	$\mu\text{V}$
		$V_{\text{CM}} = V^- + 0.1\text{V}$	●	250	750	$\mu\text{V}$
$V_{\text{OS TC}}$	Input Offset Voltage Drift (Note 3)	$V_{\text{CM}} = V^+$	●	0.5	2.5	$\mu\text{V}/^{\circ}\text{C}$
		$V_{\text{CM}} = V^-$	●	1.5	4.0	$\mu\text{V}/^{\circ}\text{C}$
$\Delta V_{\text{OS}}$	Input Offset Voltage Shift	$V_{\text{CM}} = V^- + 0.1\text{V}$ to $V^+$	●	250	650	$\mu\text{V}$
	Input Offset Voltage Match (Channel-to-Channel)	$V_{\text{CM}} = V^- + 0.1\text{V}, V^+$ (Note 5)	●	300	1500	$\mu\text{V}$
$I_B$	Input Bias Current	$V_{\text{CM}} = V^+$	●	0	350	nA
		$V_{\text{CM}} = V^- + 0.1\text{V}$	●	-975	-350	0
$\Delta I_B$	Input Bias Current Shift	$V_{\text{CM}} = V^- + 0.1\text{V}$ to $V^+$	●	700	1950	nA
	Input Bias Current Match (Channel-to-Channel)	$V_{\text{CM}} = V^+$ (Note 5) $V_{\text{CM}} = V^- + 0.1\text{V}$ (Note 5)	● ●	0 -180	30 -30	180 0
$I_{\text{OS}}$	Input Offset Current	$V_{\text{CM}} = V^+$	●	15	110	nA
		$V_{\text{CM}} = V^- + 0.1\text{V}$	●	15	110	nA
$\Delta I_{\text{OS}}$	Input Offset Current Shift	$V_{\text{CM}} = V^- + 0.1\text{V}$ to $V^+$	●	30	220	nA
$A_{\text{VOL}}$	Large-Signal Voltage Gain	$V_S = 5\text{V}, V_O = 75\text{mV}$ to $4.8\text{V}, R_L = 10\text{k}$	●	400	2500	V/mV
		$V_S = 3\text{V}, V_O = 75\text{mV}$ to $2.8\text{V}, R_L = 10\text{k}$	●	300	2000	V/mV
CMRR	Common Mode Rejection Ratio	$V_S = 5\text{V}, V_{\text{CM}} = V^- + 0.1\text{V}$ to $V^+$	●	77	86	dB
		$V_S = 3\text{V}, V_{\text{CM}} = V^- + 0.1\text{V}$ to $V^+$	●	73	81	dB
	CMRR Match (Channel-to-Channel) (Note 5)	$V_S = 5\text{V}, V_{\text{CM}} = V^- + 0.1\text{V}$ to $V^+$ $V_S = 3\text{V}, V_{\text{CM}} = V^- + 0.1\text{V}$ to $V^+$	● ●	72 69	86 83	dB dB
PSRR	Power Supply Rejection Ratio	$V_S = 2.5\text{V}$ to $12\text{V}, V_{\text{CM}} = V_O = 0.5\text{V}$	●	86	100	dB
	PSRR Match (Channel-to-Channel) (Note 5)	$V_S = 2.5\text{V}$ to $12\text{V}, V_{\text{CM}} = V_O = 0.5\text{V}$	●	80	100	dB
$V_{\text{OL}}$	Output Voltage Swing (Low) (Note 6)	No Load	●	18	40	mV
		$I_{\text{SINK}} = 0.5\text{mA}$	●	45	80	mV
		$I_{\text{SINK}} = 2.5\text{mA}$	●	110	220	mV
$V_{\text{OH}}$	Output Voltage Swing (High) (Note 6)	No Load	●	3.5	15	mV
		$I_{\text{SOURCE}} = 0.5\text{mA}$	●	60	120	mV
		$I_{\text{SOURCE}} = 2.5\text{mA}$	●	170	300	mV
$I_{\text{SC}}$	Short-Circuit Current	$V_S = 5\text{V}$	●	$\pm 7.5$	$\pm 15$	mA
		$V_S = 3\text{V}$	●	$\pm 7.5$	$\pm 15$	mA
$I_S$	Supply Current per Amplifier		●	2.0	2.7	mA
GBW	Gain-Bandwidth Product (Note 7)		●	5.8	8.5	MHz
SR	Slew Rate (Note 8)	$V_S = 5\text{V}, A_V = -1, R_L = \text{Open}, V_O = 4\text{V}$	●	2.2	3.6	V/ $\mu\text{s}$
		$V_S = 3\text{V}, A_V = -1, R_L = \text{Open}$	●	1.9	3.2	V/ $\mu\text{s}$

## ELECTRICAL CHARACTERISTICS

The ● denotes the specifications which apply over the temperature range  $-40^{\circ}\text{C} < T_A < 125^{\circ}\text{C}$ .  $V_S = 5\text{V}, 0\text{V}$ ;  $V_S = 3\text{V}, 0\text{V}$ ;  $V_{\text{CM}} = V_{\text{OUT}} = \text{half supply}$ , unless otherwise noted. (Note 4)

SYMBOL	PARAMETER	CONDITIONS	MIN	TYP	MAX	UNITS
$V_{\text{OS}}$	Input Offset Voltage	$V_{\text{CM}} = V^+ - 0.5\text{V}$	●	300	1100	$\mu\text{V}$
		$V_{\text{CM}} = V^- + 0.5\text{V}$	●	300	1100	$\mu\text{V}$
$V_{\text{OS TC}}$	Input Offset Voltage Drift (Note 3)		●	0.5		$\mu\text{V}/^{\circ}\text{C}$
		$V_{\text{CM}} = V^+ - 0.5\text{V}$	●	1.5		$\mu\text{V}/^{\circ}\text{C}$
$\Delta V_{\text{OS}}$	Input Offset Voltage Shift	$V_{\text{CM}} = V^- + 0.5\text{V}$ to $V^+ - 0.5\text{V}$	●	250	2300	$\mu\text{V}$
	Input Offset Voltage Match (Channel-to-Channel)	$V_{\text{CM}} = V^- + 0.5\text{V}, V^+ - 0.5\text{V}$ (Note 5)	●	300	1900	$\mu\text{V}$
$I_B$	Input Bias Current	$V_{\text{CM}} = V^+ - 0.5\text{V}$	●	0	1100	nA
		$V_{\text{CM}} = V^- + 0.5\text{V}$	●	-1100	0	nA
$\Delta I_B$	Input Bias Current Shift	$V_{\text{CM}} = V^- + 0.5\text{V}$ to $V^+ - 0.5\text{V}$	●	900	2200	nA
	Input Bias Current Match (Channel-to-Channel)	$V_{\text{CM}} = V^+ - 0.5\text{V}$ (Note 5) $V_{\text{CM}} = V^- + 0.5\text{V}$ (Note 5)	● ●	0 -400	400 0	nA nA
$I_{\text{OS}}$	Input Offset Current	$V_{\text{CM}} = V^+ - 0.5\text{V}$	●	40	300	nA
		$V_{\text{CM}} = V^- + 0.5\text{V}$	●	40	300	nA
$\Delta I_{\text{OS}}$	Input Offset Current Shift	$V_{\text{CM}} = V^- + 0.5\text{V}$ to $V^+ - 0.5\text{V}$	●	80	600	nA
$A_{\text{VOL}}$	Large-Signal Voltage Gain	$V_S = 5\text{V}, V_O = 0.5\text{V}$ to $4.5\text{V}, R_L = 10\text{k}$	●	40	210	V/mV
		$V_S = 3\text{V}, V_O = 0.5\text{V}$ to $2.5\text{V}, R_L = 10\text{k}$	●	20	210	V/mV
CMRR	Common Mode Rejection Ratio	$V_S = 5\text{V}, V_{\text{CM}} = V^- + 0.5\text{V}$ to $V^+ - 0.5\text{V}$ $V_S = 3\text{V}, V_{\text{CM}} = V^- + 0.5\text{V}$ to $V^+ - 0.5\text{V}$	● ●	66 62	80 75	dB dB
	CMRR Match (Channel-to-Channel) (Note 5)	$V_S = 5\text{V}, V_{\text{CM}} = V^- + 0.5\text{V}$ to $V^+ - 0.5\text{V}$ $V_S = 3\text{V}, V_{\text{CM}} = V^- + 0.5\text{V}$ to $V^+ - 0.5\text{V}$	● ●	62 58	80 75	dB dB
PSRR	Power Supply Rejection Ratio	$V_S = 2.5\text{V}$ to $12\text{V}, V_{\text{CM}} = V_O = 0.5\text{V}$	●	86	100	dB
	PSRR Match (Channel-to-Channel) (Note 5)	$V_S = 2.5\text{V}$ to $12\text{V}, V_{\text{CM}} = V_O = 0.5\text{V}$	●	80	100	dB
$V_{\text{OL}}$	Output Voltage Swing (Low) (Note 6)	No Load	●	22	50	mV
		$I_{\text{SINK}} = 0.5\text{mA}$	●	45	80	mV
		$I_{\text{SINK}} = 2.5\text{mA}$	●	110	220	mV
$V_{\text{OH}}$	Output Voltage Swing (High) (Note 6)	No Load	●	3.5	20	mV
		$I_{\text{SOURCE}} = 0.5\text{mA}$	●	60	120	mV
		$I_{\text{SOURCE}} = 2.5\text{mA}$	●	170	350	mV
$I_{\text{SC}}$	Short-Circuit Current	$V_S = 5\text{V}$	●	$\pm 5$	$\pm 15$	mA
		$V_S = 3\text{V}$	●	$\pm 5$	$\pm 15$	mA
$I_S$	Supply Current per Amplifier		●	2.4	3.0	mA
GBW	Gain-Bandwidth Product (Note 7)		●	5.8	8.5	MHz
SR	Slew Rate (Note 8)	$V_S = 5\text{V}, A_V = -1, R_L = \text{Open}, V_O = 4\text{V}$	●	2.0	3.6	V/ $\mu\text{s}$
		$V_S = 3\text{V}, A_V = -1, R_L = \text{Open}$	●	1.7	3.2	V/ $\mu\text{s}$

**ELECTRICAL CHARACTERISTICS** The ● denotes the specifications which apply over the temperature range  $-55^{\circ}\text{C} < T_A < 125^{\circ}\text{C}$ .  $V_S = 5\text{V}, 0\text{V}$ ;  $V_S = 3\text{V}, 0\text{V}$ ;  $V_{CM} = V_{OUT} = \text{half supply}$ , unless otherwise noted. (Note 4)

SYMBOL	PARAMETER	CONDITIONS	MIN	TYP	MAX	UNITS
$V_{OS}$	Input Offset Voltage	$V_{CM} = V^+ - 0.5\text{V}$	●	300	1100	$\mu\text{V}$
		$V_{CM} = V^- + 0.5\text{V}$	●	300	1100	$\mu\text{V}$
$V_{OS\ TC}$	Input Offset Voltage Drift (Note 3)		●	0.5		$\mu\text{V}/^{\circ}\text{C}$
		$V_{CM} = V^+ - 0.5\text{V}$	●	1.5		$\mu\text{V}/^{\circ}\text{C}$
$\Delta V_{OS}$	Input Offset Voltage Shift	$V_{CM} = V^- + 0.5\text{V}$ to $V^+ - 0.5\text{V}$	●	250	2300	$\mu\text{V}$
	Input Offset Voltage Match (Channel-to-Channel)	$V_{CM} = V^- + 0.5\text{V}, V^+ - 0.5\text{V}$ (Note 5)	●	300	1900	$\mu\text{V}$
$I_B$	Input Bias Current	$V_{CM} = V^+ - 0.5\text{V}$	●	0	450	nA
		$V_{CM} = V^- + 0.5\text{V}$	●	-1100	-450	0
$\Delta I_B$	Input Bias Current Shift	$V_{CM} = V^- + 0.5\text{V}$ to $V^+ - 0.5\text{V}$	●	900	2200	nA
	Input Bias Current Match (Channel-to-Channel)	$V_{CM} = V^+ - 0.5\text{V}$ (Note 5) $V_{CM} = V^- + 0.5\text{V}$ (Note 5)	● ●	0 -400	40 400	nA nA
$I_{OS}$	Input Offset Current	$V_{CM} = V^+ - 0.5\text{V}$	●	40	300	nA
		$V_{CM} = V^- + 0.5\text{V}$	●	40	300	nA
$\Delta I_{OS}$	Input Offset Current Shift	$V_{CM} = V^- + 0.5\text{V}$ to $V^+ - 0.5\text{V}$	●	80	600	nA
$A_{VOL}$	Large-Signal Voltage Gain	$V_S = 5\text{V}, V_O = 0.5\text{V}$ to $4.5\text{V}, R_L = 10\text{k}$	●	40	210	V/mV
		$V_S = 3\text{V}, V_O = 0.5\text{V}$ to $2.5\text{V}, R_L = 10\text{k}$	●	20	210	V/mV
CMRR	Common Mode Rejection Ratio	$V_S = 5\text{V}, V_{CM} = V^- + 0.5\text{V}$ to $V^+ - 0.5\text{V}$ $V_S = 3\text{V}, V_{CM} = V^- + 0.5\text{V}$ to $V^+ - 0.5\text{V}$	● ●	66 62	80 75	dB dB
	CMRR Match (Channel-to-Channel) (Note 5)	$V_S = 5\text{V}, V_{CM} = V^- + 0.5\text{V}$ to $V^+ - 0.5\text{V}$ $V_S = 3\text{V}, V_{CM} = V^- + 0.5\text{V}$ to $V^+ - 0.5\text{V}$	● ●	62 58	80 75	dB dB
PSRR	Power Supply Rejection Ratio	$V_S = 2.5\text{V}$ to $12\text{V}, V_{CM} = V_O = 0.5\text{V}$	●	86	100	dB
	PSRR Match (Channel-to-Channel) (Note 5)	$V_S = 2.5\text{V}$ to $12\text{V}, V_{CM} = V_O = 0.5\text{V}$	●	80	100	dB
$V_{OL}$	Output Voltage Swing (Low) (Note 6)	No Load	●	22	50	mV
		$I_{SINK} = 0.5\text{mA}$	●	45	80	mV
		$I_{SINK} = 2.5\text{mA}$	●	110	220	mV
$V_{OH}$	Output Voltage Swing (High) (Note 6)	No Load	●	3.5	20	mV
		$I_{SOURCE} = 0.5\text{mA}$	●	60	120	mV
		$I_{SOURCE} = 2.5\text{mA}$	●	170	350	mV
$I_{SC}$	Short-Circuit Current	$V_S = 5\text{V}$	●	$\pm 5$	$\pm 15$	mA
		$V_S = 3\text{V}$	●	$\pm 5$	$\pm 15$	mA
$I_S$	Supply Current per Amplifier		●	2.4	3.0	mA
GBW	Gain-Bandwidth Product (Note 7)		●	5.8	8.5	MHz
SR	Slew Rate (Note 8)	$V_S = 5\text{V}, A_V = -1, R_L = \text{Open}, V_O = 4\text{V}$	●	2.0	3.6	V/ $\mu\text{s}$
		$V_S = 3\text{V}, A_V = -1, R_L = \text{Open}$	●	1.7	3.2	V/ $\mu\text{s}$

## ELECTRICAL CHARACTERISTICS $T_A = 25^\circ\text{C}$ , $V_S = \pm 15\text{V}$ , $V_{CM} = 0\text{V}$ , $V_{OUT} = 0\text{V}$ , unless otherwise noted.

SYMBOL	PARAMETER	CONDITIONS	MIN	TYP	MAX	UNITS
$V_{OS}$	Input Offset Voltage	$V_{CM} = V^+$		200	800	$\mu\text{V}$
		$V_{CM} = V^-$		200	800	$\mu\text{V}$
$\Delta V_{OS}$	Input Offset Voltage Shift	$V_{CM} = V^-$ to $V^+$		150	650	$\mu\text{V}$
	Input Offset Voltage Match (Channel-to-Channel)	$V_{CM} = V^+$ , $V^-$ (Note 5)		250	1400	$\mu\text{V}$
$I_B$	Input Bias Current	$V_{CM} = V^+$	0	250	715	nA
		$V_{CM} = V^-$	-715	-250	0	nA
$\Delta I_B$	Input Bias Current Shift	$V_{CM} = V^-$ to $V^+$		500	1430	nA
	Input Bias Current Match (Channel-to-Channel)	$V_{CM} = V^+$ (Note 5) $V_{CM} = V^-$ (Note 5)	0 -120	12 -12	120 0	nA nA
$I_{OS}$	Input Offset Current	$V_{CM} = V^+$		6	70	nA
		$V_{CM} = V^-$		6	70	nA
$\Delta I_{OS}$	Input Offset Current Shift	$V_{CM} = V^-$ to $V^+$		12	140	nA
	Input Noise Voltage	0.1Hz to 10Hz		400		nV <sub>p-p</sub>
$e_n$	Input Noise Voltage Density	$f = 1\text{kHz}$		12		nV/ $\sqrt{\text{Hz}}$
$i_n$	Input Noise Current Density	$f = 1\text{kHz}$		0.3		pA/ $\sqrt{\text{Hz}}$
$A_{VOL}$	Large-Signal Voltage Gain	$V_O = -14.5\text{V}$ to $14.5\text{V}$ , $R_L = 10\text{k}$	1000	5200		V/mV
		$V_O = -10\text{V}$ to $10\text{V}$ , $R_L = 2\text{k}$	500	2300		V/mV
	Channel Separation	$V_O = -10\text{V}$ to $10\text{V}$ , $R_L = 2\text{k}$	116	130		dB
CMRR	Common Mode Rejection Ratio	$V_{CM} = V^-$ to $V^+$	93	106		dB
	CMRR Match (Channel-to-Channel) (Note 5)	$V_{CM} = V^-$ to $V^+$	87	103		dB
PSRR	Power Supply Rejection Ratio	$V_S = \pm 5\text{V}$ to $\pm 15\text{V}$	89	110		dB
	PSRR Match (Channel-to-Channel) (Note 5)	$V_S = \pm 5\text{V}$ to $\pm 15\text{V}$	83	105		dB
$V_{OL}$	Output Voltage Swing (Low) (Note 6)	No Load		18	30	mV
		$I_{SINK} = 0.5\text{mA}$		40	80	mV
		$I_{SINK} = 10\text{mA}$		230	500	mV
$V_{OH}$	Output Voltage Swing (High) (Note 6)	No Load		2.5	10	mV
		$I_{SOURCE} = 0.5\text{mA}$		55	120	mV
		$I_{SOURCE} = 10\text{mA}$		420	800	mV
$I_{SC}$	Short-Circuit Current		$\pm 15$	$\pm 30$		mA
$I_S$	Supply Current per Amplifier			1.8	2.5	mA
GBW	Gain-Bandwidth Product (Note 7)		6.8	10.5		MHz
SR	Slew Rate	$A_V = -1$ , $R_L = \text{Open}$ , $V_O = \pm 10\text{V}$ Measure at $V_O = \pm 5\text{V}$	3.5	6		V/ $\mu\text{s}$



**ELECTRICAL CHARACTERISTICS** The ● denotes the specifications which apply over the temperature range 0°C < T<sub>A</sub> < 70°C. V<sub>S</sub> = ±15V, V<sub>CM</sub> = 0V, V<sub>OUT</sub> = 0V, unless otherwise noted.

SYMBOL	PARAMETER	CONDITIONS	MIN	TYP	MAX	UNITS
V <sub>OS</sub>	Input Offset Voltage	V <sub>CM</sub> = V <sup>+</sup>	●	200	900	μV
		V <sub>CM</sub> = V <sup>-</sup> + 0.1V	●	200	900	μV
V <sub>OS</sub> TC	Input Offset Voltage Drift (Note 3)	V <sub>CM</sub> = V <sup>+</sup>	●	1.0	3.5	μV/°C
			●	2.0	5.0	μV/°C
ΔV <sub>OS</sub>	Input Offset Voltage Shift	V <sub>CM</sub> = V <sup>-</sup> + 0.1V to V <sup>+</sup>	●	200	750	μV
	Input Offset Voltage Match (Channel-to-Channel)	V <sub>CM</sub> = V <sup>-</sup> + 0.1V, V <sup>+</sup> (Note 5)	●	350	1500	μV
I <sub>B</sub>	Input Bias Current	V <sub>CM</sub> = V <sup>+</sup>	●	0	300	nA
		V <sub>CM</sub> = V <sup>-</sup> + 0.1V	●	-875	-300	0
ΔI <sub>B</sub>	Input Bias Current Shift	V <sub>CM</sub> = V <sup>-</sup> + 0.1V to V <sup>+</sup>	●	600	1750	nA
	Input Bias Current Match (Channel-to-Channel)	V <sub>CM</sub> = V <sup>+</sup> (Note 5) V <sub>CM</sub> = V <sup>-</sup> + 0.1V (Note 5)	● ●	0 -180	20 -20	180 0
I <sub>OS</sub>	Input Offset Current	V <sub>CM</sub> = V <sup>+</sup>	●	15	90	nA
		V <sub>CM</sub> = V <sup>-</sup> + 0.1V	●	15	90	nA
ΔI <sub>OS</sub>	Input Offset Current Shift	V <sub>CM</sub> = V <sup>-</sup> + 0.1V to V <sup>+</sup>	●	30	180	nA
A <sub>VOL</sub>	Large-Signal Voltage Gain	V <sub>O</sub> = -14.5V to 14.5V, R <sub>L</sub> = 10k V <sub>O</sub> = -10V to 10V, R <sub>L</sub> = 2k	● ●	900 400	5000 2000	V/mV V/mV
	Channel Separation	V <sub>O</sub> = -10V to 10V, R <sub>L</sub> = 2k	●	112	125	dB
CMRR	Common Mode Rejection Ratio	V <sub>CM</sub> = V <sup>-</sup> + 0.1V to V <sup>+</sup>	●	92	103	dB
	CMRR Match (Channel-to-Channel) (Note 5)	V <sub>CM</sub> = V <sup>-</sup> + 0.1V to V <sup>+</sup>	●	86	103	dB
PSRR	Power Supply Rejection Ratio	V <sub>S</sub> = ±5V to ±15V	●	88	103	dB
	PSRR Match (Channel-to-Channel) (Note 5)	V <sub>S</sub> = ±5V to ±15V	●	82	103	dB
V <sub>OL</sub>	Output Voltage Swing (Low) (Note 6)	No Load	●	18	40	mV
		I <sub>SINK</sub> = 0.5mA	●	45	90	mV
		I <sub>SINK</sub> = 10mA	●	270	520	mV
V <sub>OH</sub>	Output Voltage Swing (High) (Note 6)	No Load	●	3.5	15	mV
		I <sub>SOURCE</sub> = 0.5mA	●	60	120	mV
		I <sub>SOURCE</sub> = 10mA	●	480	1000	mV
I <sub>SC</sub>	Short-Circuit Current		●	±12	±28	mA
I <sub>S</sub>	Supply Current per Amplifier		●	1.9	2.8	mA
GBW	Gain-Bandwidth Product (Note 7)		●	6.1	9	MHz
SR	Slew Rate	A <sub>V</sub> = -1, R <sub>L</sub> = Open, V <sub>O</sub> = ±10V Measured at V <sub>O</sub> = ±5V	●	3.4	5.3	V/μs

## ELECTRICAL CHARACTERISTICS

The ● denotes the specifications which apply over the temperature range  $-40^{\circ}\text{C} < T_A < 85^{\circ}\text{C}$ .  $V_S = \pm 15\text{V}$ ,  $V_{CM} = 0\text{V}$ ,  $V_{OUT} = 0\text{V}$ , unless otherwise noted. (Note 4)

SYMBOL	PARAMETER	CONDITIONS	MIN	TYP	MAX	UNITS
$V_{OS}$	Input Offset Voltage	$V_{CM} = V^+$	●	300	950	$\mu\text{V}$
		$V_{CM} = V^- + 0.1\text{V}$	●	300	950	$\mu\text{V}$
$V_{OS\ TC}$	Input Offset Voltage Drift (Note 3)		●	1.0	3.5	$\mu\text{V}/^{\circ}\text{C}$
		$V_{CM} = V^+$	●	2.0	5.0	$\mu\text{V}/^{\circ}\text{C}$
$\Delta V_{OS}$	Input Offset Voltage Shift	$V_{CM} = V^- + 0.1\text{V}$ to $V^+$	●	250	850	$\mu\text{V}$
	Input Offset Voltage Match (Channel-to-Channel)	$V_{CM} = V^- + 0.1\text{V}$ , $V^+$ (Note 5)	●	350	1800	$\mu\text{V}$
$I_B$	Input Bias Current	$V_{CM} = V^+$	●	0	350	nA
		$V_{CM} = V^- + 0.1\text{V}$	●	-1050	-350	0
$\Delta I_B$	Input Bias Current Shift	$V_{CM} = V^- + 0.1\text{V}$ to $V^+$	●	700	2100	nA
	Input Bias Current Match (Channel-to-Channel)	$V_{CM} = V^+$ (Note 5) $V_{CM} = V^- + 0.1\text{V}$ (Note 5)	● ●	0 -200	20 -20	200 0
$I_{OS}$	Input Offset Current	$V_{CM} = V^+$	●	15	115	nA
		$V_{CM} = V^- + 0.1\text{V}$	●	15	115	nA
$\Delta I_{OS}$	Input Offset Current Shift	$V_{CM} = V^- + 0.1\text{V}$ to $V^+$	●	30	230	nA
$A_{VOL}$	Large-Signal Voltage Gain	$V_O = -14.5\text{V}$ to $14.5\text{V}$ , $R_L = 10\text{k}$ $V_O = -10\text{V}$ to $10\text{V}$ , $R_L = 2\text{k}$	● ●	800 350	5000 2000	V/mV V/mV
	Channel Separation	$V_O = -10\text{V}$ to $10\text{V}$ , $R_L = 2\text{k}$	●	110	120	dB
CMRR	Common Mode Rejection Ratio	$V_{CM} = V^- + 0.1\text{V}$ to $V^+$	●	90	101	dB
	CMRR Match (Channel-to-Channel) (Note 5)	$V_{CM} = V^- + 0.1\text{V}$ to $V^+$	●	86	100	dB
PSRR	Power Supply Rejection Ratio	$V_S = \pm 5\text{V}$ to $\pm 15\text{V}$	●	88	100	dB
	PSRR Match (Channel-to-Channel) (Note 5)	$V_S = \pm 5\text{V}$ to $\pm 15\text{V}$	●	82	100	dB
$V_{OL}$	Output Voltage Swing (Low) (Note 6)	No Load	●	25	50	mV
		$I_{SINK} = 0.5\text{mA}$	●	50	100	mV
		$I_{SINK} = 10\text{mA}$	●	275	520	mV
$V_{OH}$	Output Voltage Swing (High) (Note 6)	No Load	●	3.5	15	mV
		$I_{SOURCE} = 0.5\text{mA}$	●	65	120	mV
		$I_{SOURCE} = 10\text{mA}$	●	500	1000	mV
$I_{SC}$	Short-Circuit Current		●	$\pm 10$	$\pm 18$	mA
$I_S$	Supply Current per Amplifier		●	2.0	3.0	mA
GBW	Gain-Bandwidth Product (Note 7)		●	5.8	8.5	MHz
SR	Slew Rate	$A_V = -1$ , $R_L = \text{Open}$ , $V_O = \pm 10\text{V}$ Measure at $V_O = \pm 5\text{V}$	●	3	4.75	V/ $\mu\text{s}$

**ELECTRICAL CHARACTERISTICS** The ● denotes the specifications which apply over the temperature range  $-40^{\circ}\text{C} < T_A < 125^{\circ}\text{C}$ .  $V_S = \pm 15\text{V}$ ,  $V_{CM} = 0\text{V}$ ,  $V_{OUT} = 0\text{V}$ , unless otherwise noted. (Note 4)

SYMBOL	PARAMETER	CONDITIONS	MIN	TYP	MAX	UNITS
$V_{OS}$	Input Offset Voltage	$V_{CM} = V^+ - 0.5\text{V}$	●	350	1300	$\mu\text{V}$
		$V_{CM} = V^- + 0.5\text{V}$	●	350	1300	$\mu\text{V}$
$V_{OS\ TC}$	Input Offset Voltage Drift (Note 3)		●	1.0		$\mu\text{V}/^{\circ}\text{C}$
		$V_{CM} = V^+ - 0.5\text{V}$	●	2.0		$\mu\text{V}/^{\circ}\text{C}$
$\Delta V_{OS}$	Input Offset Voltage Shift	$V_{CM} = V^- + 0.5\text{V}$ to $V^+ - 0.5\text{V}$	●	250	1500	$\mu\text{V}$
	Input Offset Voltage Match (Channel-to-Channel)	$V_{CM} = V^- + 0.5\text{V}$ , $V^+ - 0.5\text{V}$ (Note 5)	●	400	2200	$\mu\text{V}$
$I_B$	Input Bias Current	$V_{CM} = V^+ - 0.5\text{V}$	●	0	500	nA
		$V_{CM} = V^- + 0.5\text{V}$	●	-1200	-500	0
$\Delta I_B$	Input Bias Current Shift	$V_{CM} = V^- + 0.5\text{V}$ to $V^+ - 0.5\text{V}$	●	1000	2400	nA
	Input Bias Current Match (Channel-to-Channel)	$V_{CM} = V^+ - 0.5\text{V}$ (Note 5) $V_{CM} = V^- + 0.5\text{V}$ (Note 5)	● ●	0 -400	40 -40	400 0
$I_{OS}$	Input Offset Current	$V_{CM} = V^+ - 0.5\text{V}$	●	40	300	nA
		$V_{CM} = V^- + 0.5\text{V}$	●	40	300	nA
$\Delta I_{OS}$	Input Offset Current Shift	$V_{CM} = V^- + 0.5\text{V}$ to $V^+ - 0.5\text{V}$	●	80	600	nA
$A_{VOL}$	Large-Signal Voltage Gain	$V_O = -14.5\text{V}$ to $14.5\text{V}$ , $R_L = 10\text{k}$	●	40	400	V/mV
	Channel Separation	$V_O = -10\text{V}$ to $10\text{V}$ , $R_L = 2\text{k}$	●	110	120	dB
CMRR	Common Mode Rejection Ratio	$V_{CM} = V^- + 0.5\text{V}$ to $V^+ - 0.5\text{V}$	●	86	100	dB
	CMRR Match (Channel-to-Channel) (Note 5)	$V_{CM} = V^- + 0.5\text{V}$ to $V^+ - 0.5\text{V}$	●	80	100	dB
PSRR	Power Supply Rejection Ratio	$V_S = \pm 5\text{V}$ to $\pm 15\text{V}$	●	88	100	dB
	PSRR Match (Channel-to-Channel) (Note 5)	$V_S = \pm 5\text{V}$ to $\pm 15\text{V}$	●	80	100	dB
$V_{OL}$	Output Voltage Swing (Low) (Note 6)	No Load	●	25	75	mV
		$I_{SINK} = 0.5\text{mA}$	●	50	100	mV
		$I_{SINK} = 10\text{mA}$	●	275	520	mV
$V_{OH}$	Output Voltage Swing (High) (Note 6)	No Load	●	3.5	20	mV
		$I_{SOURCE} = 0.5\text{mA}$	●	65	120	mV
		$I_{SOURCE} = 10\text{mA}$	●	500	1400	mV
$I_{SC}$	Short-Circuit Current		●	$\pm 7.5$	$\pm 12$	mA
$I_S$	Supply Current per Amplifier		●	2.5	3.2	mA
GBW	Gain-Bandwidth Product (Note 7)		●	5.8	8.5	MHz
SR	Slew Rate	$A_V = -1$ , $R_L = \text{Open}$ , $V_O = \pm 10\text{V}$ Measure at $V_O = \pm 5\text{V}$	●	2.2	4.75	V/ $\mu\text{s}$

## ELECTRICAL CHARACTERISTICS

The ● denotes the specifications which apply over the temperature range  $-55^{\circ}\text{C} < T_A < 125^{\circ}\text{C}$ .  $V_S = \pm 15\text{V}$ ,  $V_{\text{CM}} = 0\text{V}$ ,  $V_{\text{OUT}} = 0\text{V}$ , unless otherwise noted. (Note 4)

SYMBOL	PARAMETER	CONDITIONS	MIN	TYP	MAX	UNITS
$V_{\text{OS}}$	Input Offset Voltage	$V_{\text{CM}} = V^+ - 0.5\text{V}$	●	350	1300	$\mu\text{V}$
		$V_{\text{CM}} = V^- + 0.5\text{V}$	●	350	1300	$\mu\text{V}$
$V_{\text{OS TC}}$	Input Offset Voltage Drift (Note 3)		●	1.0		$\mu\text{V}/^{\circ}\text{C}$
		$V_{\text{CM}} = V^+ - 0.5\text{V}$	●	2.0		$\mu\text{V}/^{\circ}\text{C}$
$\Delta V_{\text{OS}}$	Input Offset Voltage Shift	$V_{\text{CM}} = V^- + 0.5\text{V}$ to $V^+ - 0.5\text{V}$	●	250	1500	$\mu\text{V}$
	Input Offset Voltage Match (Channel-to-Channel)	$V_{\text{CM}} = V^- + 0.5\text{V}$ , $V^+ - 0.5\text{V}$ (Note 5)	●	400	2200	$\mu\text{V}$
$I_{\text{B}}$	Input Bias Current	$V_{\text{CM}} = V^+ - 0.5\text{V}$	●	0	500	nA
		$V_{\text{CM}} = V^- + 0.5\text{V}$	●	-1200	-500	0
$\Delta I_{\text{B}}$	Input Bias Current Shift	$V_{\text{CM}} = V^- + 0.5\text{V}$ to $V^+ - 0.5\text{V}$	●	1000	2400	nA
	Input Bias Current Match (Channel-to-Channel)	$V_{\text{CM}} = V^+ - 0.5\text{V}$ (Note 5) $V_{\text{CM}} = V^- + 0.5\text{V}$ (Note 5)	● ●	0 -400	40 -40	400 0
$I_{\text{OS}}$	Input Offset Current	$V_{\text{CM}} = V^+ - 0.5\text{V}$	●	40	300	nA
		$V_{\text{CM}} = V^- + 0.5\text{V}$	●	40	300	nA
$\Delta I_{\text{OS}}$	Input Offset Current Shift	$V_{\text{CM}} = V^- + 0.5\text{V}$ to $V^+ - 0.5\text{V}$	●	80	600	nA
$A_{\text{VOL}}$	Large-Signal Voltage Gain	$V_{\text{O}} = -14.5\text{V}$ to $14.5\text{V}$ , $R_{\text{L}} = 10\text{k}$	●	40	400	V/mV
	Channel Separation	$V_{\text{O}} = -10\text{V}$ to $10\text{V}$ , $R_{\text{L}} = 2\text{k}$	●	110	120	dB
CMRR	Common Mode Rejection Ratio	$V_{\text{CM}} = V^- + 0.5\text{V}$ to $V^+ - 0.5\text{V}$	●	86	100	dB
	CMRR Match (Channel-to-Channel) (Note 5)	$V_{\text{CM}} = V^- + 0.5\text{V}$ to $V^+ - 0.5\text{V}$	●	80	100	dB
PSRR	Power Supply Rejection Ratio	$V_{\text{S}} = \pm 5\text{V}$ to $\pm 15\text{V}$	●	88	100	dB
	PSRR Match (Channel-to-Channel) (Note 5)	$V_{\text{S}} = \pm 5\text{V}$ to $\pm 15\text{V}$	●	80	100	dB
$V_{\text{OL}}$	Output Voltage Swing (Low) (Note 6)	No Load	●	25	75	mV
		$I_{\text{SINK}} = 0.5\text{mA}$	●	50	100	mV
		$I_{\text{SINK}} = 10\text{mA}$	●	275	520	mV
$V_{\text{OH}}$	Output Voltage Swing (High) (Note 6)	No Load	●	3.5	20	mV
		$I_{\text{SOURCE}} = 0.5\text{mA}$	●	65	120	mV
		$I_{\text{SOURCE}} = 10\text{mA}$	●	500	1400	mV
$I_{\text{SC}}$	Short-Circuit Current		●	$\pm 7.5$	$\pm 12$	mA
$I_{\text{S}}$	Supply Current per Amplifier		●	2.5	3.2	mA
GBW	Gain-Bandwidth Product (Note 7)		●	5.8	8.5	MHz
SR	Slew Rate	$A_{\text{V}} = -1$ , $R_{\text{L}} = \text{Open}$ , $V_{\text{O}} = \pm 10\text{V}$ Measure at $V_{\text{O}} = \pm 5\text{V}$	●	2.2	4.75	V/ $\mu\text{s}$

**Note 1:** Stresses beyond those listed under Absolute Maximum Ratings may cause permanent damage to the device. Exposure to any Absolute Maximum Rating condition for extended periods may affect device reliability and lifetime.

**Note 2:** A heat sink may be required to keep the junction temperature below the absolute maximum rating when the output is shorted indefinitely.

**Note 3:** This parameter is not 100% tested.

**Note 4:** The LT1498C/LT1499C are guaranteed to meet specified performance from  $0^{\circ}\text{C}$  to  $70^{\circ}\text{C}$ . The LT1498C/LT1499C are designed, characterized and expected to meet specified performance from  $-40^{\circ}\text{C}$  to  $85^{\circ}\text{C}$  but are not tested or QA sampled at these temperatures. The LT1498I/LT1499I are guaranteed to meet specified performance from  $-40^{\circ}\text{C}$  to  $85^{\circ}\text{C}$ . The LT1498H/LT1499H are guaranteed to meet specified performance from  $-40^{\circ}\text{C}$  to  $125^{\circ}\text{C}$ . The LT1498MP is guaranteed to meet specified performance from  $-55^{\circ}\text{C}$  to  $125^{\circ}\text{C}$ .

**Note 5:** Matching parameters are the difference between amplifiers A and D and between B and C on the LT1499; between the two amplifiers on the LT1498.

**Note 6:** Output voltage swings are measured between the output and power supply rails.

**Note 7:**  $V_{\text{S}} = 3\text{V}$ ,  $V_{\text{S}} = \pm 15\text{V}$  GBW limit guaranteed by correlation to 5V tests.

**Note 8:**  $V_{\text{S}} = 3\text{V}$ ,  $V_{\text{S}} = 5\text{V}$  slew rate limit guaranteed by correlation to  $\pm 15\text{V}$  tests.

# TYPICAL PERFORMANCE CHARACTERISTICS

**$V_{OS}$  Distribution,  $V_{CM} = 0V$  (PNP Stage)**

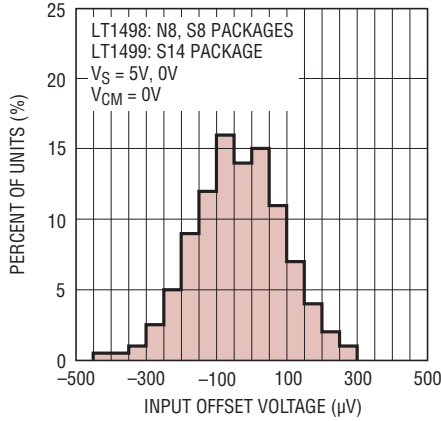

14989 G01

**$V_{OS}$  Distribution  $V_{CM} = 5V$  (NPN Stage)**

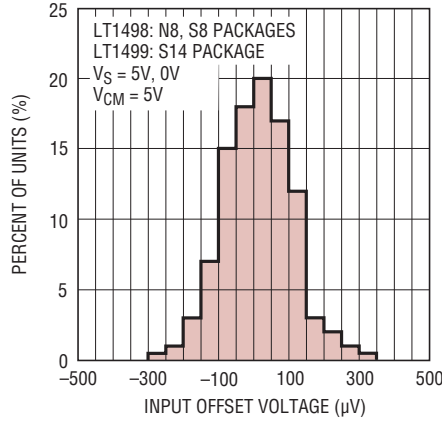

14989 G02

**$\Delta V_{OS}$  Shift for  $V_{CM} = 0V$  to  $5V$**

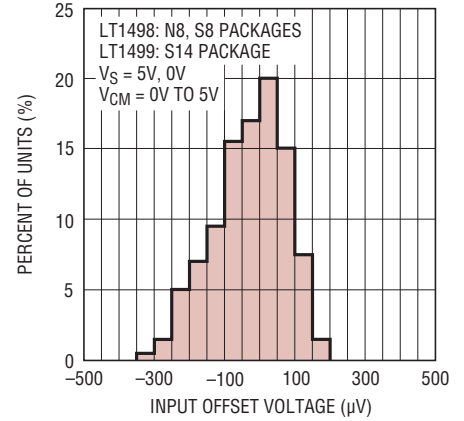

14989 G03

**Supply Current vs Supply Voltage**



14989 G04

**Supply Current vs Temperature**



14989 G05

**Input Bias Current vs Common Mode Voltage**



14989 G06

**Input Bias Current vs Temperature**



14989 G07

**Output Saturation Voltage vs Load Current (Output High)**



14989 G08

**Output Saturation Voltage vs Load Current (Output Low)**



14989 G09

TYPICAL PERFORMANCE CHARACTERISTICS

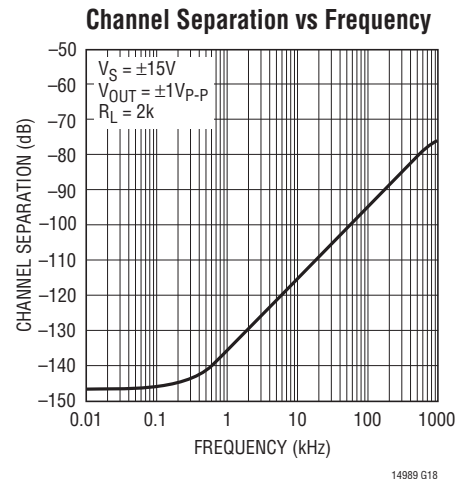
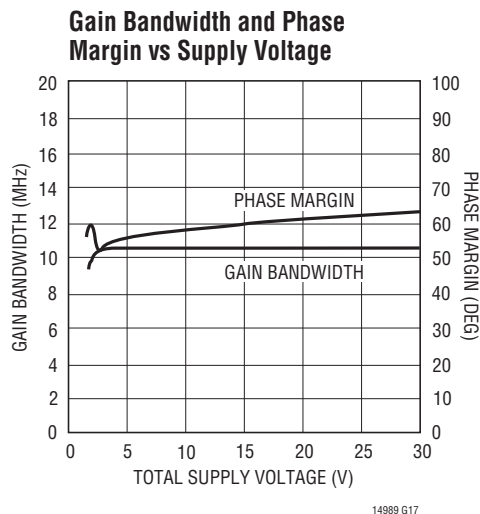
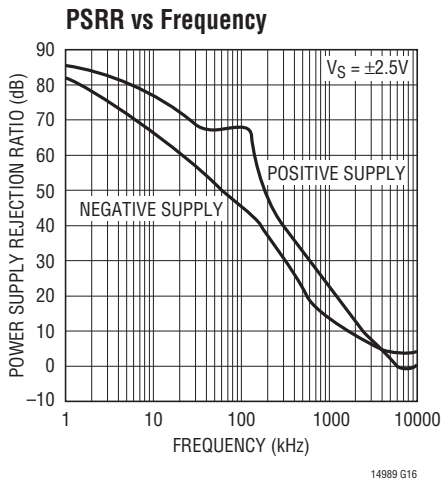
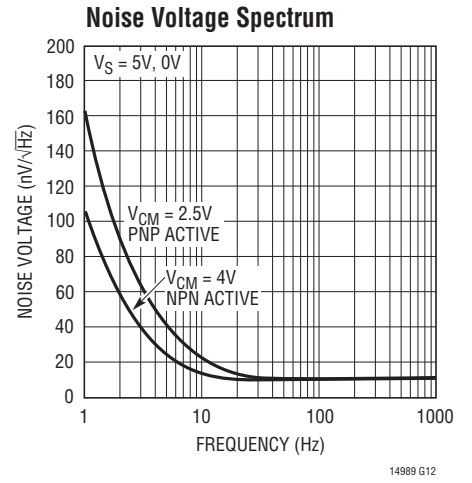
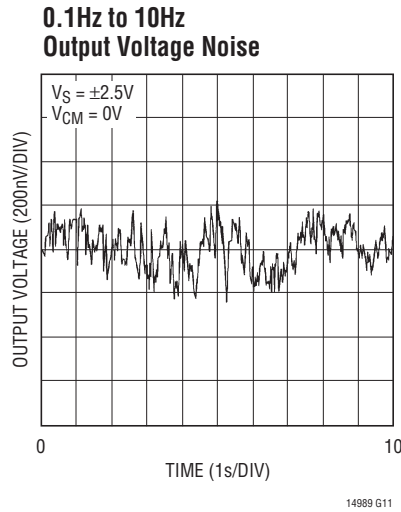
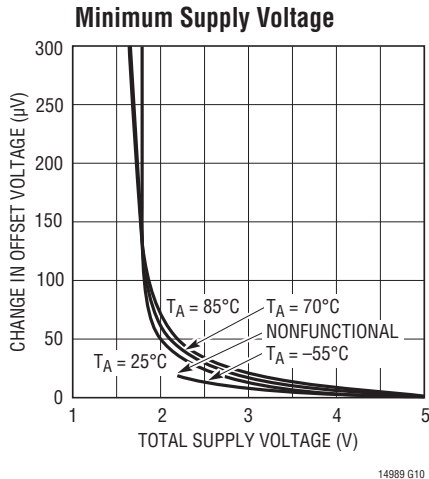

# TYPICAL PERFORMANCE CHARACTERISTICS

**Capacitive Load Handling**

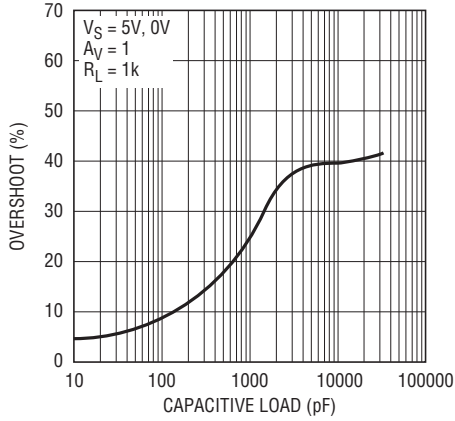

14989 G19

**Slew Rate vs Supply Voltage**

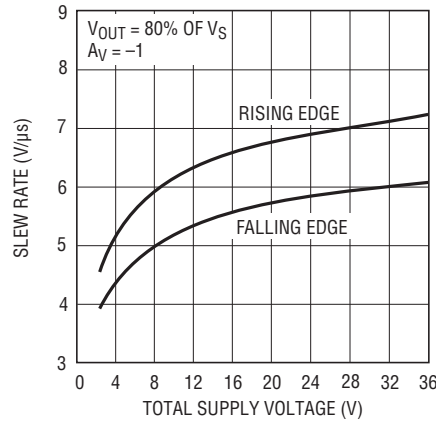

14989 G20

**Output Step vs Settling Time to 0.01%**

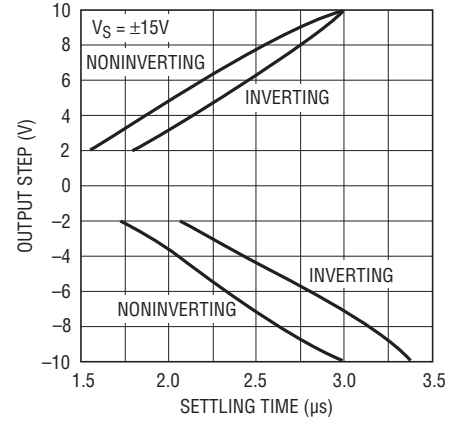

14989 G21

**Open-Loop Gain**



14989 G22

**Open-Loop Gain**

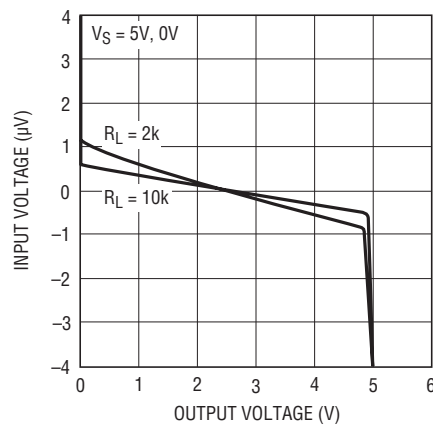

14989 G23

**Warm-Up Drift vs Time**



14989 G24

**Total Harmonic Distortion + Noise vs Peak-to-Peak Voltage**



14989 G25

**Total Harmonic Distortion + Noise vs Frequency**



14989 G26

**TYPICAL PERFORMANCE CHARACTERISTICS**

**5V Small-Signal Response**

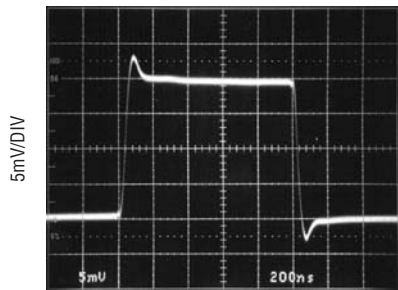

$V_S = 5V$  200ns/DIV 14989 G27  
 $A_V = 1$   
 $V_{IN} = 20mV_{p-p}$  AT 50kHz  
 $R_L = 1k$

**5V Large-Signal Response**

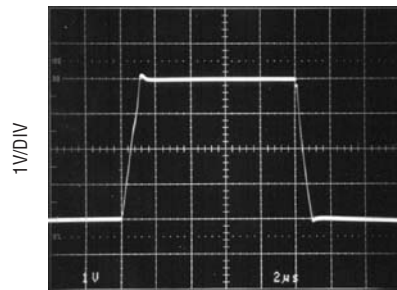

$V_S = 5V$  2µs/DIV 14989 G28  
 $A_V = 1$   
 $V_{IN} = 4V_{p-p}$  AT 10kHz  
 $R_L = 1k$

**±15V Small-Signal Response**

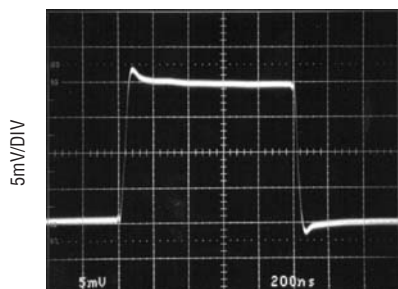

$V_S = \pm 15V$  200ns/DIV 14989 G29  
 $A_V = 1$   
 $V_{IN} = 20mV_{p-p}$  AT 50kHz  
 $R_L = 1k$

**±15V Large-Signal Response**

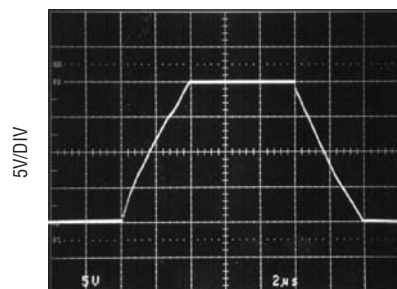

$V_S = \pm 15V$  2µs/DIV 14989 G30  
 $A_V = 1$   
 $V_{IN} = 20V_{p-p}$  AT 10kHz  
 $R_L = 1k$



## APPLICATIONS INFORMATION

### Rail-to-Rail Input and Output

The LT1498/LT1499 are fully functional for an input and output signal range from the negative supply to the positive supply. Figure 1 shows a simplified schematic of the amplifier. The input stage consists of two differential amplifiers, a PNP stage (Q1/Q2) and an NPN stage (Q3/Q4) which are active over different ranges of input common mode voltage. A complementary common emitter output stage (Q14/Q15) is employed allowing the output to swing from rail-to-rail. The devices are fabricated on Linear Technology's proprietary complementary bipolar process to ensure very similar DC and AC characteristics for the output devices (Q14/Q15).

The PNP differential input pair is active for input common mode voltages,  $V_{CM}$ , between the negative supply to approximately 1.3V below the positive supply. As  $V_{CM}$  moves further toward the positive supply, the transistor (Q5) will steer the tail current,  $I_1$ , to the current mirror (Q6/Q7) activating the NPN differential pair, and the PNP differential pair becomes inactive for the rest of the input common mode range up to the positive supply.

The output is configured with a pair of complementary common emitter stages that enables the output to swing from rail to rail. Capacitors (C1 and C2) form local feedback loops that lower the output impedance at high frequencies.

### Input Offset Voltage

The offset voltage changes depending upon which input stage is active. The input offsets are random, but are trimmed to less than  $475\mu\text{V}$ . To maintain the precision characteristics of the amplifier, the change of  $V_{OS}$  over the entire input common mode range (CMRR) is guaranteed to be less than  $425\mu\text{V}$  on a single 5V supply.

### Input Bias Current

The input bias current polarity also depends on the input common mode voltage, as described in the previous section. When the PNP differential pair is active, the input bias currents flow out of the input pins; they flow in opposite direction when the NPN input stage is active. The offset error due to input bias current can be minimized by equalizing the noninverting and inverting input source impedances. This will reduce the error since the input offset currents are much less than the input bias currents.



Figure 1. LT1498 Simplified Schematic Diagram

## APPLICATIONS INFORMATION

### Overdrive Protection

To prevent the output from reversing polarity when the input voltage exceeds the power supplies, two pair of crossing diodes D1 to D4 are employed. When the input voltage exceeds either power supply by approximately 700mV, D1/D2 or D3/D4 will turn on, forcing the output to the proper polarity. For the phase reversal protection to work properly, the input current must be less than 5mA. If the amplifier is to be severely overdriven, an external resistor should be used to limit the overdrive current.

Furthermore, the LT1498/LT1499's input stages are protected by a pair of back-to-back diodes, D5/D6. When a differential voltage of more than 0.7V is applied to the inputs, these diodes will turn on, preventing the Zener breakdown of the input transistors. The current in D5/D6 should be limited to less than 10mA. Internal resistors R6 and R7 (700Ω total) limit the input current for differential input signals of 7V or less. For larger input levels, a resistor in series with either or both inputs should be used to limit the current. Worst-case differential input voltage usually occurs when the output is shorted to ground. In addition, the amplifier is protected against ESD strikes up to 3kV on all pins.

### Capacitive Load

The LT1498/LT1499 are designed for ease of use. The amplifier can drive a capacitive load of more than 10nF without oscillation at unity gain. When driving a heavy capacitive load, the bandwidth is reduced to maintain stability. Figures 2a and 2b illustrate the stability of the device for small-signal and large-signal conditions with capacitive loads. Both the small-signal and large-signal transient response with a 10nF capacitive load are well behaved.

### Feedback Components

To minimize the loading effect of feedback, it is possible to use the high value feedback resistors to set the gain. However, care must be taken to insure that the pole formed by the feedback resistors and the total input capacitance at the inverting input does not degrade the stability of the amplifier. For instance, the LT1498/LT1499 in a noninverting gain of 2, set with two 30k resistors, will probably oscillate with 10pF total input capacitance (5pF input capacitance + 5pF board capacitance). The amplifier has a 2.5MHz crossing frequency and a 60° phase margin at 6dB of gain. The feedback resistors and the total input capacitance create a pole at 1.06MHz that induces 67° of phase shift at 2.5MHz! The solution is simple, either lower the value of the resistors or add a feedback capacitor of 10pF or more.

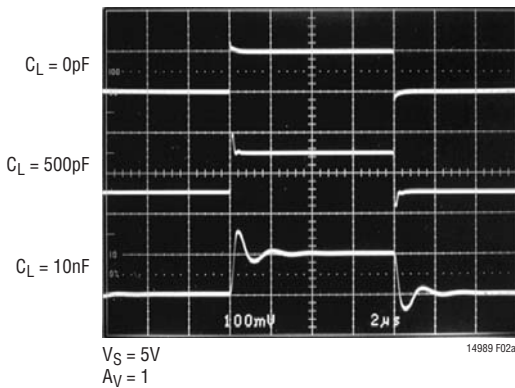

Figure 2a. LT1498 Small-Signal Response

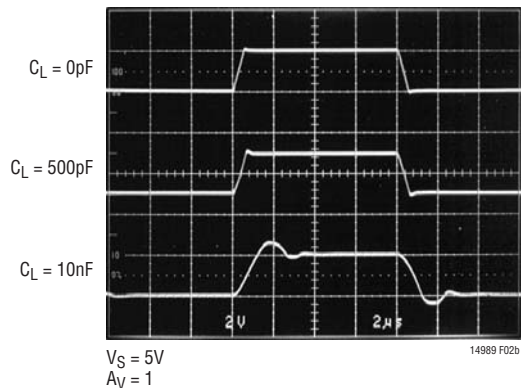
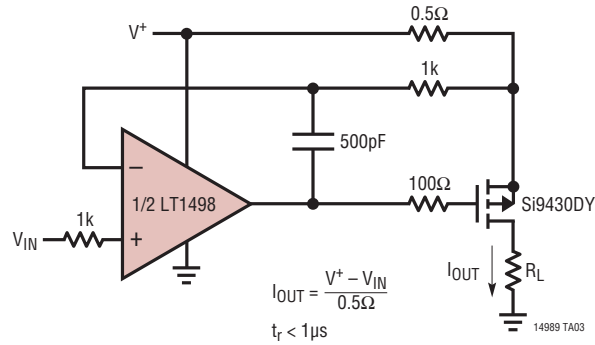

Figure 2b. LT1498 Large-Signal Response

## TYPICAL APPLICATIONS

### 1A Voltage Controlled Current Source



### 1A Voltage Controlled Current Sink

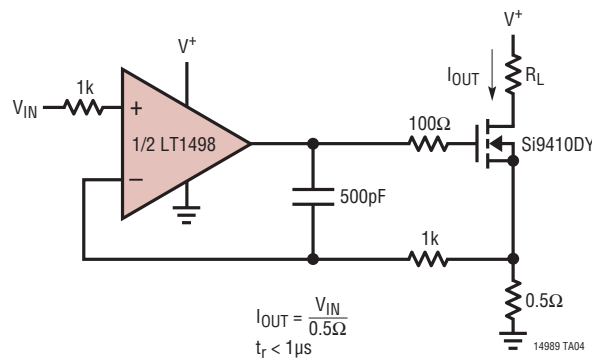

### Input Bias Current Cancellation

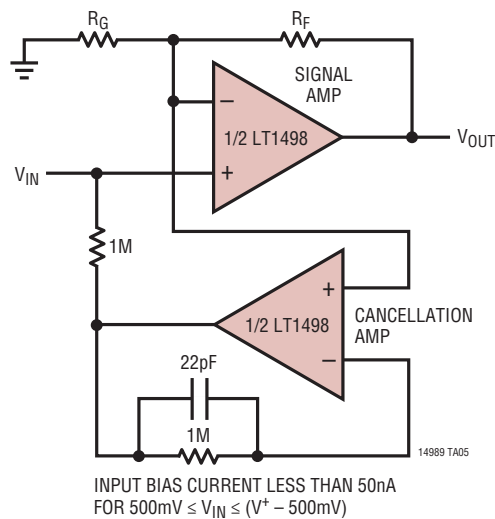

**PACKAGE DESCRIPTION**

**N8 Package**  
**8-Lead PDIP (Narrow .300 Inch)**  
 (Reference LTC DWG # 05-08-1510)



NOTE:  
 1. DIMENSIONS ARE  $\frac{\text{INCHES}}{\text{MILLIMETERS}}$   
 \*THESE DIMENSIONS DO NOT INCLUDE MOLD FLASH OR PROTRUSIONS.  
 MOLD FLASH OR PROTRUSIONS SHALL NOT EXCEED .010 INCH (0.254mm)

# PACKAGE DESCRIPTION

## S8 Package 8-Lead Plastic Small Outline (Narrow .150 Inch) (Reference LTC DWG # 05-08-1610)

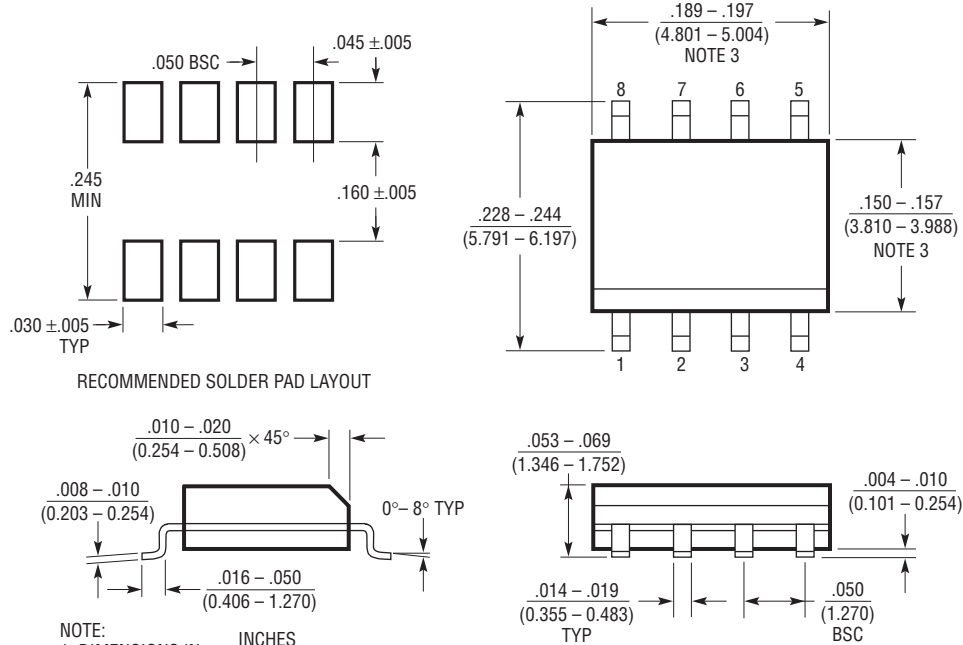

- NOTE:  
 1. DIMENSIONS IN  $\frac{\text{INCHES}}{\text{MILLIMETERS}}$   
 2. DRAWING NOT TO SCALE  
 3. THESE DIMENSIONS DO NOT INCLUDE MOLD FLASH OR PROTRUSIONS.  
 MOLD FLASH OR PROTRUSIONS SHALL NOT EXCEED  $.006"$  ( $0.15\text{mm}$ )

S08 0303

**PACKAGE DESCRIPTION**

**S Package**  
**14-Lead Plastic Small Outline (Narrow .150 Inch)**  
 (Reference LTC DWG # 05-08-1610)



- NOTE:  
 1. DIMENSIONS IN  $\frac{\text{INCHES}}{\text{MILLIMETERS}}$   
 2. DRAWING NOT TO SCALE  
 3. THESE DIMENSIONS DO NOT INCLUDE MOLD FLASH OR PROTRUSIONS.  
 MOLD FLASH OR PROTRUSIONS SHALL NOT EXCEED .006" (0.15mm)

S14 0502

**REVISION HISTORY** (Revision history begins at Rev E)

REV	DATE	DESCRIPTION	PAGE NUMBER
E	10/09	Edit in Absolute Maximum Ratings	2
F	01/10	Added LT1498H/LT1499H (H-Grade) Parts. Reflected throughout the data sheet.	2-24
G	03/10	Updated Part Markings in Order Information Section Updated Conditions for $A_{VOL}$ in Electrical Characteristics Section	2 6, 7

## TYPICAL APPLICATION

### Bidirectional Current Sensor

A bidirectional current sensor for battery-powered systems is shown in Figure 3. Two outputs are provided: one proportional to charge current, the other proportional to discharge current. The circuit takes advantage of the LT1498's rail-to-rail input range and its output phase reversal protection. During the charge cycle, the op amp

A1 forces a voltage equal to  $(I_L)(R_{SENSE})$  across  $R_A$ . This voltage is then amplified at the Charge Out by the ratio of  $R_B$  over  $R_A$ . In this mode, the output of A2 remains high, keeping Q2 off and the Discharge Out low, even though the (+) input of A2 exceeds the positive power supply. During the discharge cycle, A2 and Q2 are active and the operation is similar to the charge cycle.



Figure 3. Bidirectional Current Sensor

## RELATED PARTS

PART NUMBER	DESCRIPTION	COMMENTS
LTC®1152	Rail-to-Rail Input and Output, Zero-Drift Op Amp	High DC Accuracy, 10μV $V_{OS(MAX)}$ , 100nV/°C Drift, 1MHz GBW, 1V/μs Slew Rate, Max Supply Current 2.2mA
LT1211/LT1212	Dual/Quad 14MHz, 7V/μs, Single Supply Precision Op Amps	Input Common Mode Includes Ground, 275μV $V_{OS(MAX)}$ , 6μV/°C Max Drift, Max Supply Current 1.8mA per Op Amp
LT1213/LT1214	Dual/Quad 28MHz, 12V/μs, Single Supply Precision Op Amps	Input Common Mode Includes Ground, 275μV $V_{OS(MAX)}$ , 6μV/°C Max Drift, Max Supply Current 3.5mA per Op Amp
LT1215/LT1216	Dual/Quad 23MHz, 50V/μs, Single Supply Precision Op Amps	Input Common Mode Includes Ground, 450μV $V_{OS(MAX)}$ , Max Supply Current 6.6mA per Op Amp
LT1366/LT1367	Dual/Quad Precision, Rail-to-Rail Input and Output Op Amps	475μV $V_{OS(MAX)}$ , 400kHz GBW, 0.13V/μs Slew Rate, Max Supply Current 520μA per Op Amp
LT1490/LT1491	Dual/Quad Micropower, Rail-to-Rail Input and Output Op Amps	Max Supply Current 50μA per Op Amp, 200kHz GBW, 0.07V/μs Slew Rate, Operates with Inputs 44V Above $V^-$ Independent of $V^+$
LT1884/LT1885	Dual/Quad, Rail-to-Rail Output Picoamp Input Precision Op Amps	$I_{CC} = 650μA$ , $V_{OS} < 50μV$ , $I_B < 400pA$





Компания «ЭлектроПласт» предлагает заключение долгосрочных отношений при поставках импортных электронных компонентов на взаимовыгодных условиях!

Наши преимущества:

- Оперативные поставки широкого спектра электронных компонентов отечественного и импортного производства напрямую от производителей и с крупнейших мировых складов;
- Поставка более 17-ти миллионов наименований электронных компонентов;
- Поставка сложных, дефицитных, либо снятых с производства позиций;
- Оперативные сроки поставки под заказ (от 5 рабочих дней);
- Экспресс доставка в любую точку России;
- Техническая поддержка проекта, помощь в подборе аналогов, поставка прототипов;
- Система менеджмента качества сертифицирована по Международному стандарту ISO 9001;
- Лицензия ФСБ на осуществление работ с использованием сведений, составляющих государственную тайну;
- Поставка специализированных компонентов (Xilinx, Altera, Analog Devices, Intersil, Interpoint, Microsemi, Aeroflex, Peregrine, Syfer, Eurofarad, Texas Instrument, Miteq, Cobham, E2V, MA-COM, Hittite, Mini-Circuits, General Dynamics и др.);

Помимо этого, одним из направлений компании «ЭлектроПласт» является направление «Источники питания». Мы предлагаем Вам помощь Конструкторского отдела:

- Подбор оптимального решения, техническое обоснование при выборе компонента;
- Подбор аналогов;
- Консультации по применению компонента;
- Поставка образцов и прототипов;
- Техническая поддержка проекта;
- Защита от снятия компонента с производства.



#### Как с нами связаться

**Телефон:** 8 (812) 309 58 32 (многоканальный)

**Факс:** 8 (812) 320-02-42

**Электронная почта:** [org@eplast1.ru](mailto:org@eplast1.ru)

**Адрес:** 198099, г. Санкт-Петербург, ул. Калинина, дом 2, корпус 4, литера А.