



### FEATURES

- Patents pending
- Lower Profile
- UL60950 Recognition pending
- ANSI/AAMI ES60601-1, 2 MOOP, 1MOPP Recognition pending
- 4.2kVDC Isolation “Hi Pot Test”
- Substrate Embedded Transformer
- Automated Manufacture
- Industry Standard Footprint
- Short Circuit Protection<sup>3</sup>
- Halogen Free

### PRODUCT OVERVIEW

The NXJ1 series is a new range of low cost, lower profile, fully automated manufacture surface mount DC/DC converters. The NXJ1 series automated manufacturing process with substrate Embedded Transformer, offers increased product reliability and repeatability of performance in a halogen free, iLGA inspectable package. The NXJ1 series, industry standard footprint is compatible with existing designs.

The NXJ1 series has a MSL rating 2, and is compatible with a peak reflow solder temperature of 245°C as per J-STD-020 and J-STD-075.

### SELECTION GUIDE

Order Code <sup>1</sup>	Nominal Input Voltage	Output Voltage	Rated Input Current	Output Current	Load Regulation (Typ)	Load Regulation (Max)	Output Ripple & Noise (Typ)	Output Ripple & Noise (Max)	Efficiency (Min)	Efficiency (Typ)	Switching Frequency (Typ)	Isolation Capacitance	MTTF <sup>2</sup>
	V	V	mA	mA	%	%	mVp-p	mVp-p	%	%	kHz	pF	kHrs
<b>NXJ1S0303MC</b>	3.3	3.3	400	333	10.5	11.5	75	105	66	69.5	80	2	2430
<b>NXJ1S0305MC</b>	3.3	5	400	200	8.5	10	25	45	70	72	90	2.5	3065
<b>NXJ1S0505MC</b>	5	5	250	200	12	13.5	20	50	69	73.5	205	2.5	1988
<b>NXJ1S1205MC</b>	12	5	110	200	6	8.5	22	45	69	72	110	2.5	2244
<b>NXJ1S1212MC</b>	12	12	115	83	4.5	5	15	40	65	71	125	2.5	3473
<b>NXJ1S1215MC</b>	12	15	120	67	4	5	15	40	69	71	135	2.5	3208

### INPUT CHARACTERISTICS

Parameter	Conditions	Min.	Typ.	Max.	Units
Voltage range	Continuous operation, 3V input types	2.97	3.3	3.63	V
	Continuous operation, 5V input types	4.5	5.0	5.5	
	Continuous operation, 12V input types	10.8	12	13.2	
Input reflected ripple current	3V input		6		mA p-p
	5V input		2		
	12V input		2		

### ISOLATION CHARACTERISTICS

Parameter	Conditions	Min.	Typ.	Max.	Units
Isolation voltage	Production tested for 1 second	4200			VDC
	Qualification tested for 1 minute	4200			
Resistance	Viso= 1000VDC	10			GΩ

### OUTPUT CHARACTERISTICS

Parameter	Conditions	Min.	Typ.	Max.	Units	
Rated power	T <sub>A</sub> = -40°C to 85°C			1.0	W	
Voltage set point accuracy	See tolerance envelope					
Line regulation	High V <sub>IN</sub> to low V <sub>IN</sub>	0505 variant		1.15	1.2	%/%
		All other variants		1.1	1.2	

### TEMPERATURE CHARACTERISTICS

Parameter	Conditions	Min.	Typ.	Max.	Units
Specification	All output types	-40		85	°C
Storage		-50		125	
Product temperature rise above ambient	All output types		16		
Cooling	Free air convection				

### ABSOLUTE MAXIMUM RATINGS

Input voltage V <sub>IN</sub> , NXJ1S03 types	5.5V
Input voltage V <sub>IN</sub> , NXJ1S05 types	7V
Input voltage V <sub>IN</sub> , NXJ1S12 types	15V

1. Components are supplied in tape and reel packaging, please refer to package specification section. Orderable part numbers are NXJ1S0505MC-R7 (180 pieces per reel), or NXJ1S0505MC-R13 (800 pieces per reel).

2. Calculated using MIL-HDBK-217 FN2 calculation model with nominal input voltage at full load.

3. Please refer to short circuit application notes.

All specifications typical at T<sub>A</sub>=25°C, nominal input voltage and rated output current unless otherwise specified.



**TECHNICAL NOTES****ISOLATION VOLTAGE**

'Hi Pot Test', 'Flash Tested', 'Withstand Voltage', 'Proof Voltage', 'Dielectric Withstand Voltage' & 'Isolation Test Voltage' are all terms that relate to the same thing, a test voltage, applied for a specified time, across a component designed to provide electrical isolation, to verify the integrity of that isolation.

Murata Power Solutions NXJ1 series of DC/DC converters are all 100% production tested at 4.2kVDC for 1 second and have been qualification tested at 4.2kVDC for 1 minute.

A question commonly asked is, "What is the continuous voltage that can be applied across the part in normal operation?"

The NXJ1 series is pending recognition by Underwriters Laboratory to meet UL60950 for reinforced insulation to a working voltage of 200Vrms. When the insulation in the NXJ1 is not used as a safety barrier, i.e. provides functional isolation only, continuous or switched voltages across the barrier in excess of 1kV are sustainable. Long term reliability testing at these voltages continues. Please contact Murata for further information.

**REPEATED HIGH-VOLTAGE ISOLATION TESTING**

It is well known that repeated high-voltage isolation testing of a barrier component can actually degrade isolation capability, to a lesser or greater degree depending on materials, construction and environment. The NXJ1 series has a PCB embedded isolated transformer, using FR4 as an insulation barrier between primary and secondary windings. While parts can be expected to withstand several times the stated test voltage, the isolation capability does depend on the FR4 insulation properties. Any material, including FR4 is susceptible to eventual chemical degradation when subject to very high applied voltages thus implying that the number of tests should be strictly limited. We therefore strongly advise against repeated high voltage isolation testing, but if it is absolutely required, that the voltage should be reduced by 20% from specified test voltage.

This consideration equally applies to agency recognized parts rated for better than functional isolation where the insulation is always supplemented by a further insulation system of physical spacing or barriers.

**SAFETY APPROVAL****ANSI/AAMI ES60601-1**

The NXJ1 series is pending recognition by Underwriters Laboratory (UL) to meet ANSI/AAMI ES60601-1 medical safety standard providing the following MOOP (Means Of Operator Protection), and MOPP (Means Of Patient Protection). 2 MOOP and 1 MOPP based upon a working voltage of 200Vrms.

**UL 60950**

The NXJ1 series is pending recognition by Underwriters Laboratory (UL) to UL 60950 for reinforced insulation to a working voltage of 200Vrms.

**FUSING**

The NXJ1 Series of converters are not internally fused so to meet the requirements of UL an anti-surge input line fuse should always be used with ratings as defined below.

Input Voltage, 3.3V: 1A

Input Voltage, 5V: 0.5A

Input Voltage, 12V: 0.25A

All fuses should be UL recognized and rated to at least the maximum allowable DC input voltage.

**CHARACTERISATION TEST METHODS**

**Ripple & Noise Characterisation Method**

Ripple and noise measurements are performed with the following test configuration.

C1	1µF X7R multilayer ceramic capacitor, voltage rating to be a minimum of 3 times the output voltage of the DC/DC converter
C2	10µF tantalum capacitor, voltage rating to be a minimum of 1.5 times the output voltage of the DC/DC converter with an ESR of less than 100mΩ at 100 kHz
C3	100nF multilayer ceramic capacitor, general purpose
R1	450Ω resistor, carbon film, ±1% tolerance
R2	50Ω BNC termination
T1	3T of the coax cable through a ferrite toroid
RLOAD	Resistive load to the maximum power rating of the DC/DC converter. Connections should be made via twisted wires

Measured values are multiplied by 10 to obtain the specified values.

**Differential Mode Noise Test Schematic**

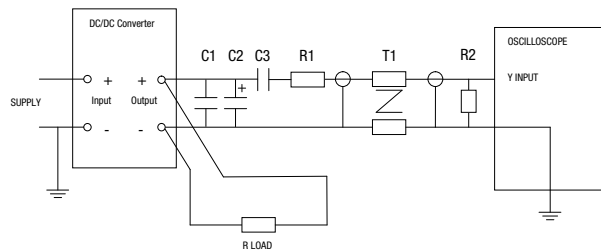

**RoHS COMPLIANCE, MSL AND PSL INFORMATION**



This series is compatible with Pb-Free soldering systems and is also backward compatible with Sn/Pb soldering systems. The NXJ1 series has a process, moisture, and reflow sensitivity classification of MSL2 PSL R7F as defined in J-STD-020 and J-STD-075. This translates to: MSL2 = 1 year floor life, PSL R7F = Peak reflow temperature 245°C with a limitation on the time above liquidus (217°C) which for this series is 90sec max. The pin termination finish on this product series is Gold with a plating thickness of 0.12 microns.

**TOLERANCE ENVELOPES**

The voltage tolerance envelope shows typical load regulation characteristics for this product series. The tolerance envelope is the maximum output voltage variation due to changes in output loading.

**NXJ1S0303MC**

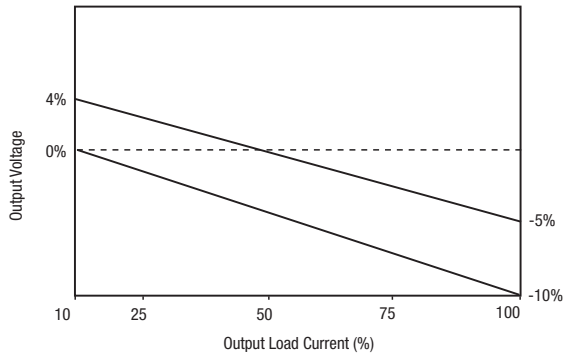

**NXJ1S0305MC**

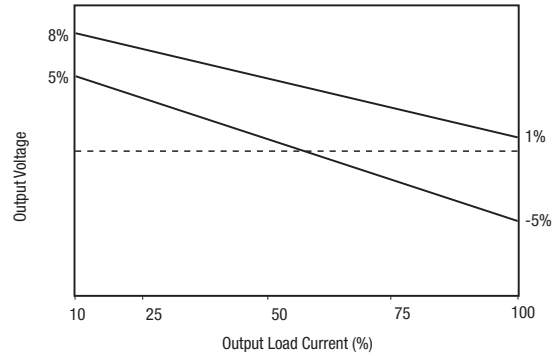

**NXJ1S0505MC**

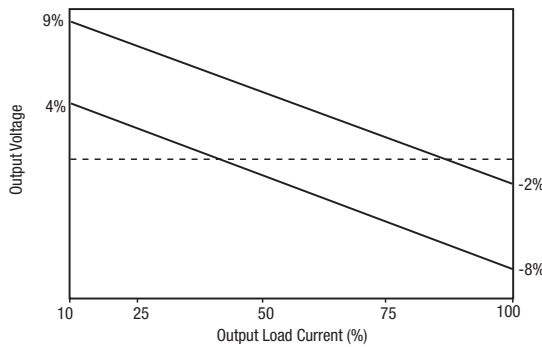

**NXJ1S1205MC**

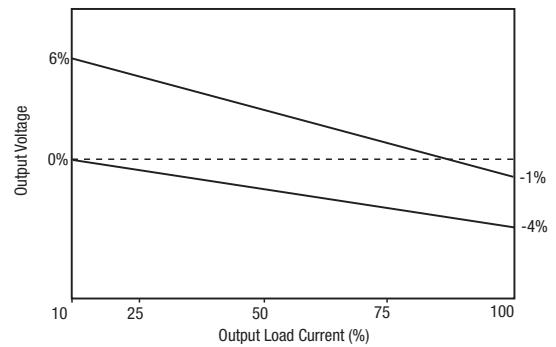

**NXJ1S1212MC**

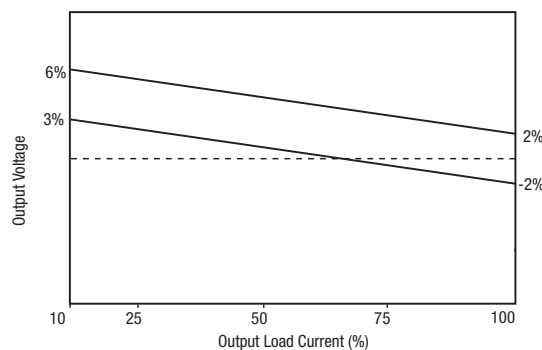

**NXJ1S1215MC**

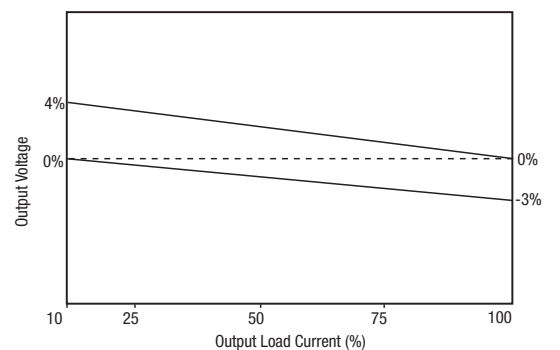

**EFFICIENCY VS LOAD**

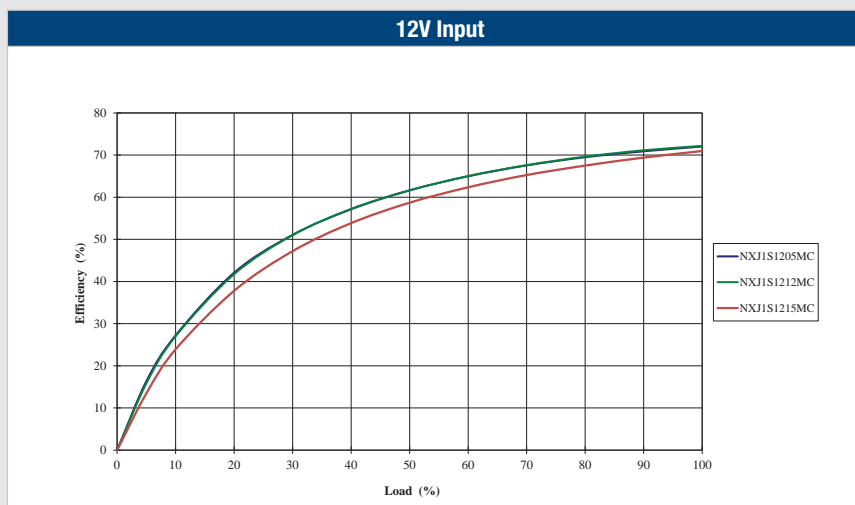
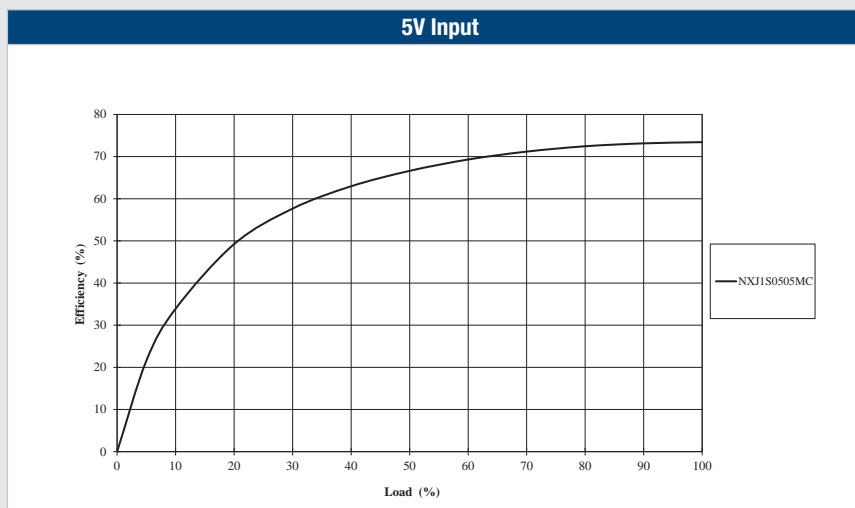
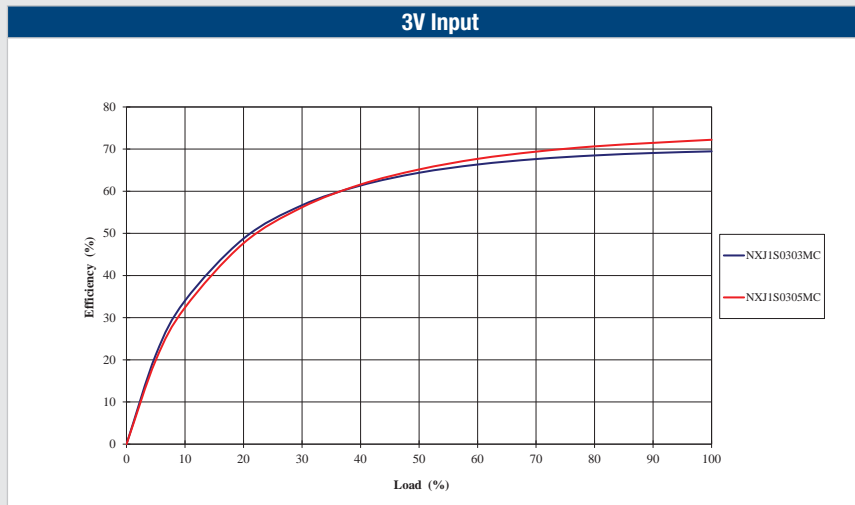

### TEMPERATURE DERATING

The derating graphs are based on the following airflow conditions, for a component mounted on a 25mm x 25mm copper covered pcb and are provided for information only. Actual performance in an application is likely to differ from these results, and a customer should evaluate the thermal environment the NXJ1 is used in, to achieve a recommended maximum component surface temperature of 85°C for the NXJ1S0303SC or 105°C for all other variants.

**NXJ1S0303MC**

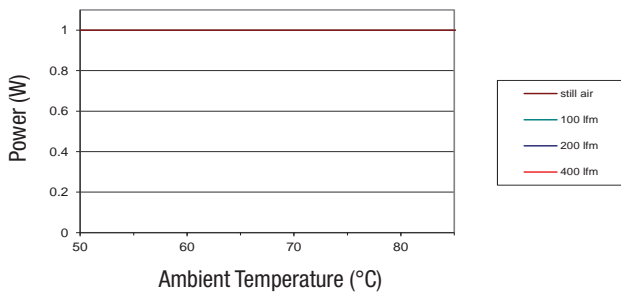

**NXJ1S0305MC**

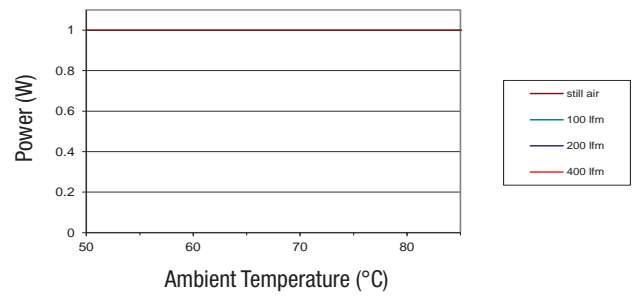

**NXJ1S0505MC**

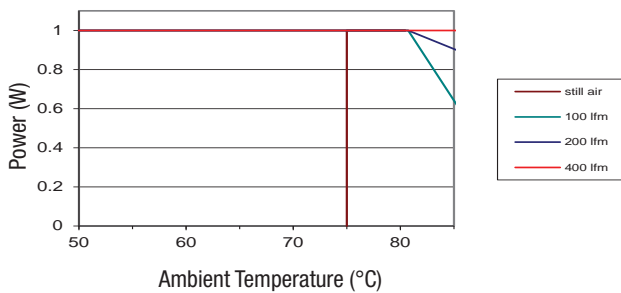

**NXJ1S1205MC**

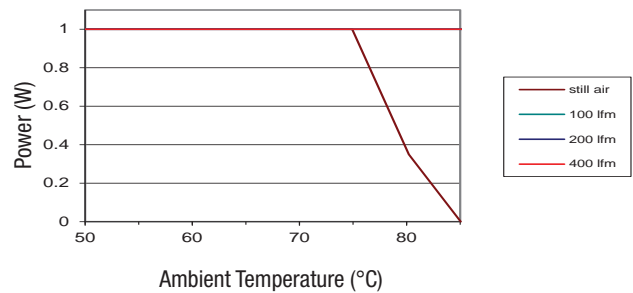

**NXJ1S1212MC**

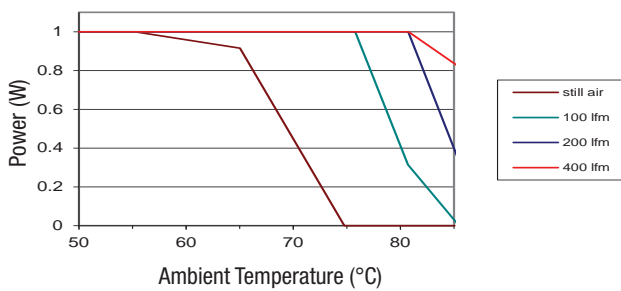

**NXJ1S1215MC**

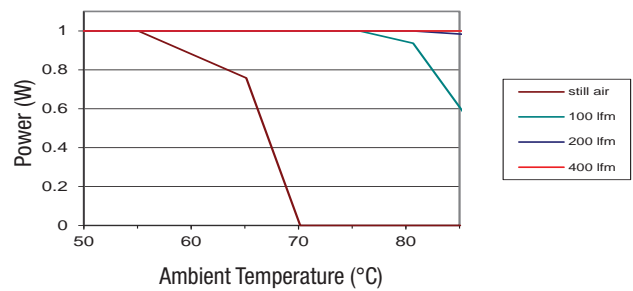

**APPLICATION NOTES**

**Short Circuit Performance**

NXJ1 short circuit protection is not continuous and varies with output voltage and temperature as shown in the following graph:

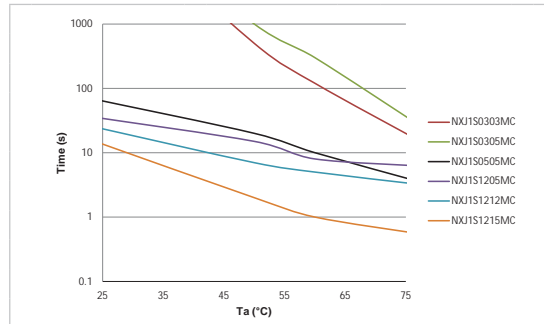

**Advisory Notes**

The NXJ1 series is not hermetically sealed, customers should ensure that parts are fully dried before input power application.

**Minimum Load**

The minimum load to meet datasheet specification is 10% of the full rated load across the specified input voltage range. Lower than 10% minimum loading will result in an increase in output voltage, which may rise to typically double the specified output voltage if the output load falls to less than 5%.

**Capacitive Loading & Start Up**

Typical start up times for this series, with a typical input voltage rise time of 2.2µs with resistive only load, and with added output capacitance of 47µF, are shown in the table below.

Part Number	Resistive Load	Resistive Load and 47µF
	Start-up time (µS)	
NXJ1S0303MC	40	190
NXJ1S0305MC	95	1700
NXJ1S0505MC	50	1100
NXJ1S1205MC	35	600
NXJ1S1212MC	80	2650
NXJ1S1215MC	100	4000

Typical Start-Up Wave Form

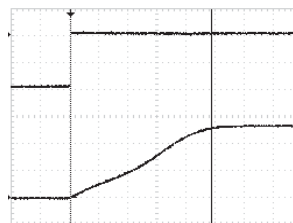

**Output Ripple Reduction**

By using the values of inductance and capacitance stated, the output ripple at the rated load is lowered to 5mV p-p max.

**Component selection**

Capacitor: It is required that the ESR (Equivalent Series Resistance) should be as low as possible, ceramic types are recommended. The voltage rating should be at least twice (except for 15V output), the rated output voltage of the DC/DC converter.

Inductor: The rated current of the inductor should not be less than that of the output of the DC/DC converter. At the rated current, the DC resistance of the inductor should be such that the voltage drop across the inductor is <2% of the rated voltage of the DC/DC converter. The SRF (Self Resonant Frequency) should be >20MHz.

	Inductor			Capacitor
	L, µH	SMD	Through Hole	C, µF
NXJ1S0303MC	4.7	82472C	11R472C	22
NXJ1S0305MC	10	82103C	11R103C	10
NXJ1S0505MC	10	82103C	11R103C	2.2
NXJ1S1205MC	10	82103C	11R103C	4.7
NXJ1S1212MC	22	82223C	11R223C	4.7
NXJ1S1215MC	22	82223C	11R223C	4.7

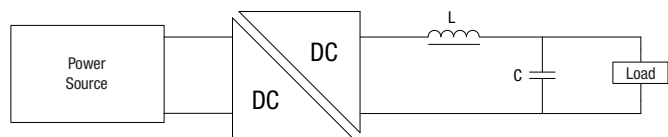

**EMC FILTERING AND SPECTRA**

**FILTERING**

The module includes a basic level of filtering. The following plots show typical spectra with EN 55022 Curve A Quasi-Peak EMC limit, with the addition of an input capacitor of 2.2 $\mu$ F and input inductor of 22 $\mu$ H.

**0303**

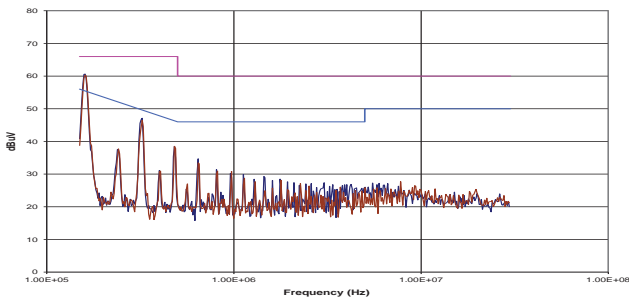

**0305**

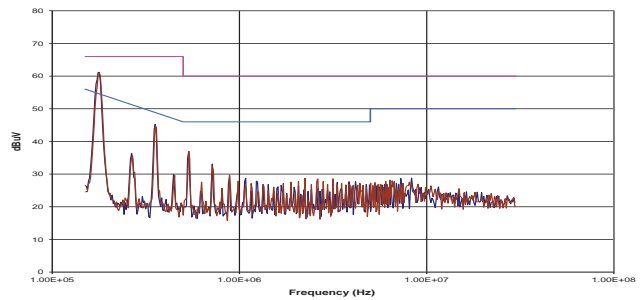

**0505**

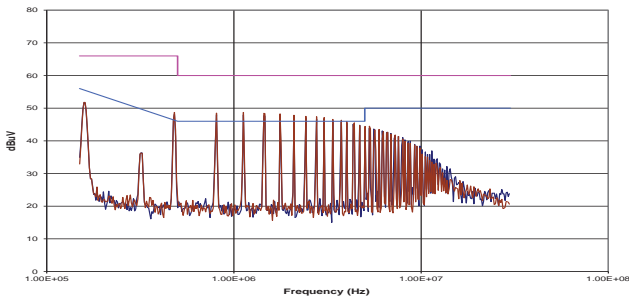

**1205**

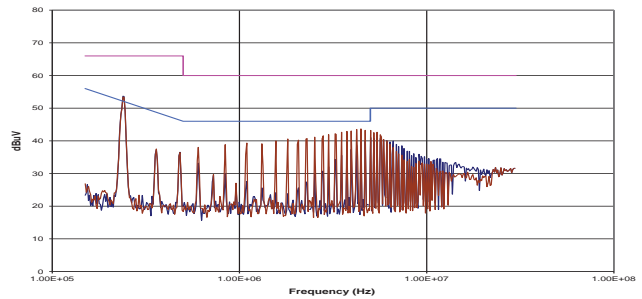

**1212**

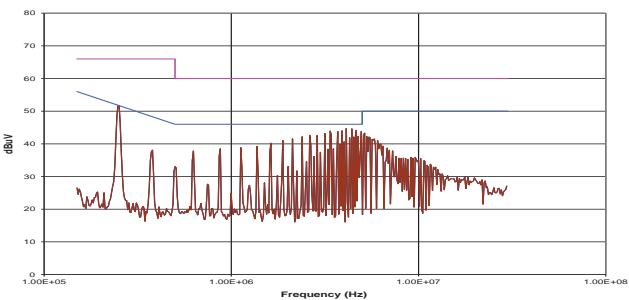

**1215**

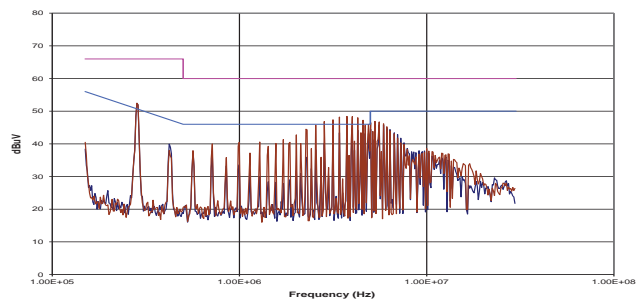



**PACKAGE SPECIFICATIONS**

**Mechanical Dimensions**

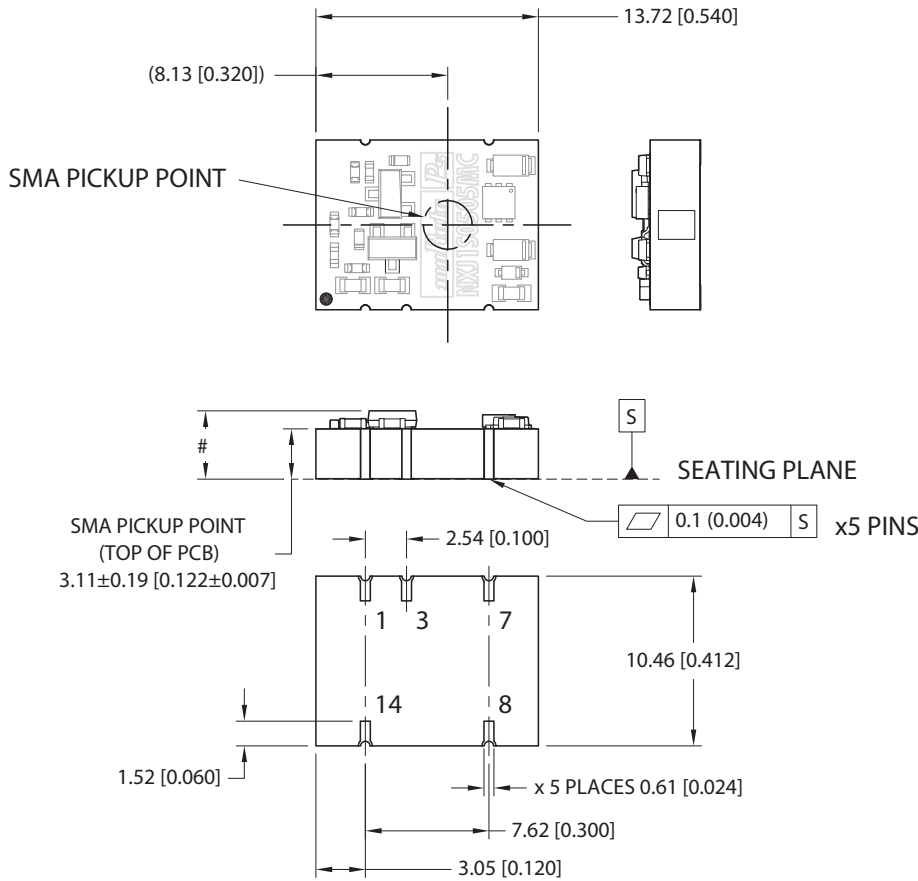

All dimensions in mm(inches). Controlling dimension is mm. Tolerances (unless otherwise stated)  $\pm 0.25$  (0.010).

Weight: 1.12g

**Pin Connections**

Pin	Function
1	-Vin
3	+Vin
7	-Vout
8	+Vout
14	NC

NC - No connection.

**Dimension Information**

Variant	Dim #
NXJ1S0303MC	4.36 $\pm$ 0.35mm
NXJ1S0305MC	[0.172 $\pm$ 0.014]
NXJ1S0505MC	
NXJ1S1205MC	4.16 $\pm$ 0.35mm
NXJ1S1212MC	[0.164 $\pm$ 0.014]
NXJ1S1215MC	

All dimensions in mm(inches). Controlling dimension is mm. Tolerances (unless otherwise stated)  $\pm 0.25$ (0.010).

**Recommended Footprint Details**

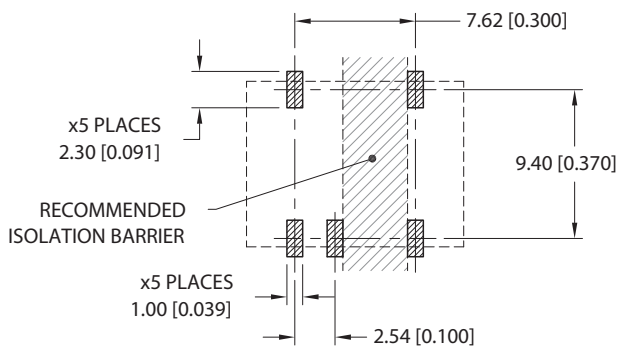

**TAPE & REEL SPECIFICATIONS**

**REEL OUTLINE DIMENSIONS**

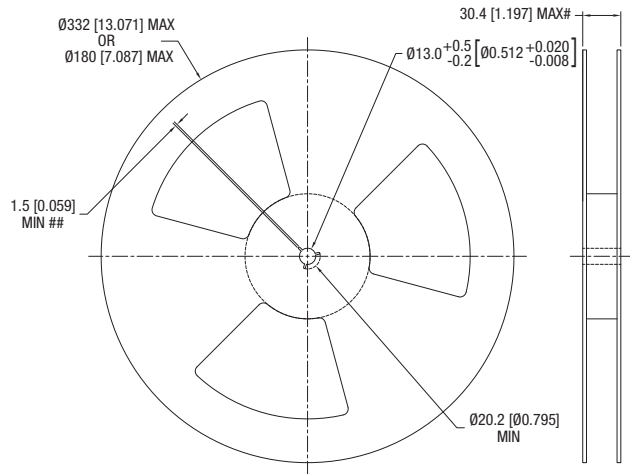

Tape & Reel specifications shall conform with current EIA-481 standard  
 Unless otherwise stated all dimensions in mm(inches)  
 Controlling dimension is mm  
 # Measured at hub  
 ## Six equi-spaced slots on 180mm/7" reel

**REEL PACKAGING DETAILS**

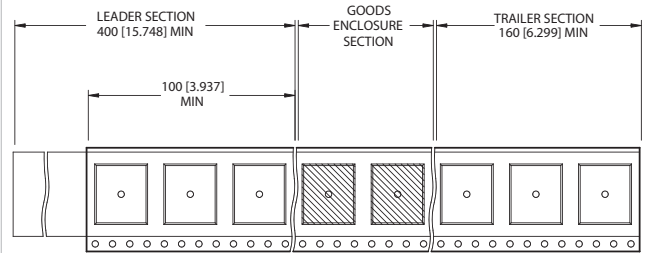

Carrier tape pockets shown are illustrative only - Refer to carrier tape diagram for actual pocket details.  
 Reel Quantity: 7" - 180 or 13" - 800

**TAPE OUTLINE DIMENSIONS**

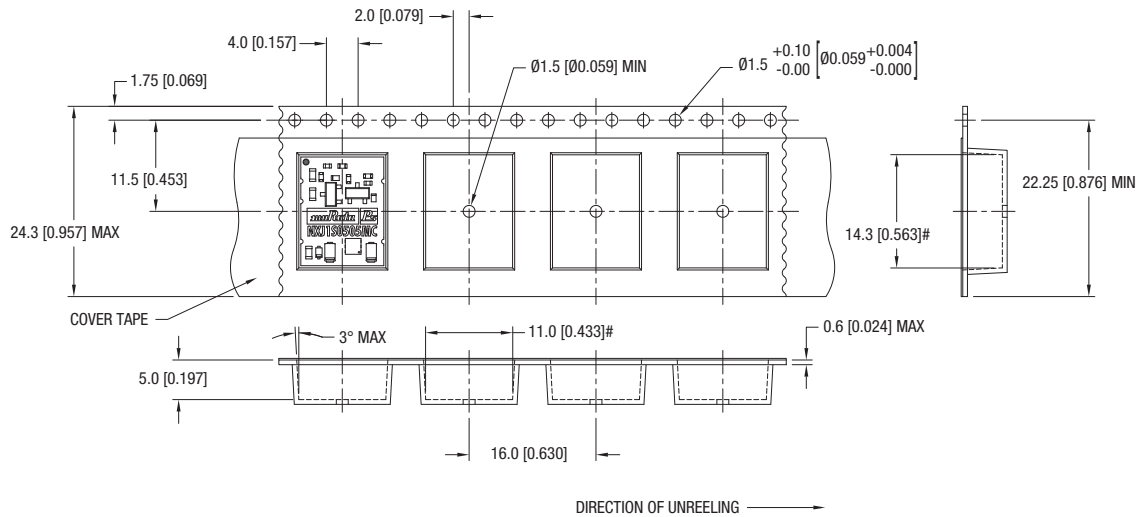

Tape & Reel specifications shall conform with current EIA-481 standard  
 Unless otherwise stated all dimensions in mm(inches) ±0.1mm (±0.004 inches)  
 Controlling dimension is mm  
 Components shall be orientated within the carrier tape as indicated  
 # Measured on a plane 0.3mm above the bottom pocket

Murata Power Solutions, Inc.  
 11 Cabot Boulevard, Mansfield, MA 02048-1151 U.S.A.  
 ISO 9001 and 14001 REGISTERED



This product is subject to the following **operating requirements** and the **Life and Safety Critical Application Sales Policy**:  
 Refer to: <http://www.murata-ps.com/requirements/>

Murata Power Solutions, Inc. makes no representation that the use of its products in the circuits described herein, or the use of other technical information contained herein, will not infringe upon existing or future patent rights. The descriptions contained herein do not imply the granting of licenses to make, use, or sell equipment constructed in accordance therewith. Specifications are subject to change without notice.  
 © 2015 Murata Power Solutions, Inc.



Компания «ЭлектроПласт» предлагает заключение долгосрочных отношений при поставках импортных электронных компонентов на взаимовыгодных условиях!

Наши преимущества:

- Оперативные поставки широкого спектра электронных компонентов отечественного и импортного производства напрямую от производителей и с крупнейших мировых складов;
- Поставка более 17-ти миллионов наименований электронных компонентов;
- Поставка сложных, дефицитных, либо снятых с производства позиций;
- Оперативные сроки поставки под заказ (от 5 рабочих дней);
- Экспресс доставка в любую точку России;
- Техническая поддержка проекта, помощь в подборе аналогов, поставка прототипов;
- Система менеджмента качества сертифицирована по Международному стандарту ISO 9001;
- Лицензия ФСБ на осуществление работ с использованием сведений, составляющих государственную тайну;
- Поставка специализированных компонентов (Xilinx, Altera, Analog Devices, Intersil, Interpoint, Microsemi, Aeroflex, Peregrine, Syfer, Eurofarad, Texas Instrument, Miteq, Cobham, E2V, MA-COM, Hittite, Mini-Circuits, General Dynamics и др.);

Помимо этого, одним из направлений компании «ЭлектроПласт» является направление «Источники питания». Мы предлагаем Вам помощь Конструкторского отдела:

- Подбор оптимального решения, техническое обоснование при выборе компонента;
- Подбор аналогов;
- Консультации по применению компонента;
- Поставка образцов и прототипов;
- Техническая поддержка проекта;
- Защита от снятия компонента с производства.



#### Как с нами связаться

**Телефон:** 8 (812) 309 58 32 (многоканальный)

**Факс:** 8 (812) 320-02-42

**Электронная почта:** [org@eplast1.ru](mailto:org@eplast1.ru)

**Адрес:** 198099, г. Санкт-Петербург, ул. Калинина, дом 2, корпус 4, литера А.