

Product Summary

$V_{(BR)DSS}$	$R_{DS(on) \max}$	$I_D \max$ $T_A = +25^\circ\text{C}$ (Notes 6)
-40V	25m Ω @ $V_{GS} = -10\text{V}$	-7.2A
	45m Ω @ $V_{GS} = -4.5\text{V}$	-5.4A

Description

This MOSFET has been designed to minimize the on-state resistance and yet maintain superior switching performance, making it ideal for high efficiency power management applications.

Applications

- Motor Control
- Backlighting
- DC-DC Converters
- Printer Equipment

Features

- Low $R_{DS(on)}$ – Minimizes conduction losses
- Fast switching speed – Minimizes switching losses
- **Totally Lead-Free & Fully RoHS compliant (Notes 1 & 2)**
- **Halogen and Antimony Free. "Green" Device (Note 3)**
- **Qualified to AEC-Q101 Standards for High Reliability**

Mechanical Data

- Case: POWERDI3333-8
- Case Material: Molded Plastic, "Green" Molding Compound. UL Flammability Classification Rating 94V-0
- Moisture Sensitivity: Level 1 per J-STD-020
- Terminals Connections: See diagram below
- Terminals: Finish - Matte Tin annealed over Copper lead frame. Solderable per MIL-STD-202, Method 208 ⁽³⁾
- Weight: 0.0172 grams (approximate)

POWERDI3333-8

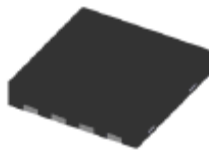

Top View

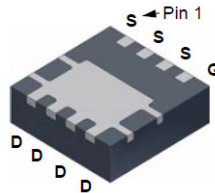

Bottom View

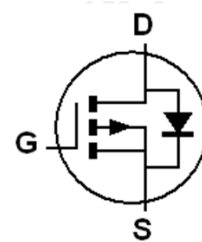

Device symbol

Ordering Information (Note 4)

Product	Marking	Reel Size (inches)	Tape Width (mm)	Quantity per Reel
DMP4025SFG-7	P40	7	8	2,000
DMP4025SFG-13	P40	13	8	3,000

- Notes:
1. No purposely added lead. Fully EU Directive 2002/95/EC (RoHS) & 2011/65/EU (RoHS 2) compliant.
 2. See http://www.diodes.com/quality/lead_free.html for more information about Diodes Incorporated's definitions of Halogen- and Antimony-free, "Green" and Lead-free.
 3. Halogen- and Antimony-free "Green" products are defined as those which contain <900ppm bromine, <900ppm chlorine (<1500ppm total Br + Cl) and <1000ppm antimony compounds.
 4. For packaging details, go to our website at <http://www.diodes.com/products/packages.html>.

Marking Information

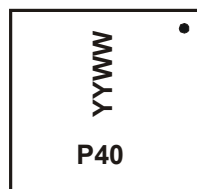

P40 = Product marking code
YYWW = Date Code Marking
YY = Year (ex: 12 = 2012)
WW = Week (01 - 53)

Maximum Ratings (@T_A = +25°C, unless otherwise specified.)

Characteristic			Symbol	Value	Units
Drain-Source Voltage			V _{DSS}	-40	V
Gate-Source Voltage			V _{GSS}	±20	
Continuous Drain Current	V _{GS} = 10V	(Notes 6)	I _D	-7.2	A
		T _A = +70°C (Notes 6)		-5.77	
		(Notes 5)		-4.65	
Pulsed Drain Current	V _{GS} = 10V	(Notes 7)	I _{DM}	-26	

Thermal Characteristics (@T_A = +25°C, unless otherwise specified.)

Characteristic		Symbol	Value	Unit
Power Dissipation	(Note 5)	P _D	0.81	W
Linear Derating Factor	(Note 6)		1.95	
Thermal Resistance, Junction to Ambient	(Note 5)	R _{θJA}	155	°C/W
	(Note 6)		64	
Operating and Storage Temperature Range		T _J , T _{STG}	-55 to +150	°C

- Notes:
- 5. Device mounted on FR-4 substrate PC board, 2oz copper, with minimum recommended pad layout
 - 6. For a device surface mounted on 25mm x 25mm FR4 PCB with 2oz copper, in still air conditions;
 - 7. Same as note (6), except the device is pulsed with D= 0.02 and pulse width 300µs.

Thermal Characteristics

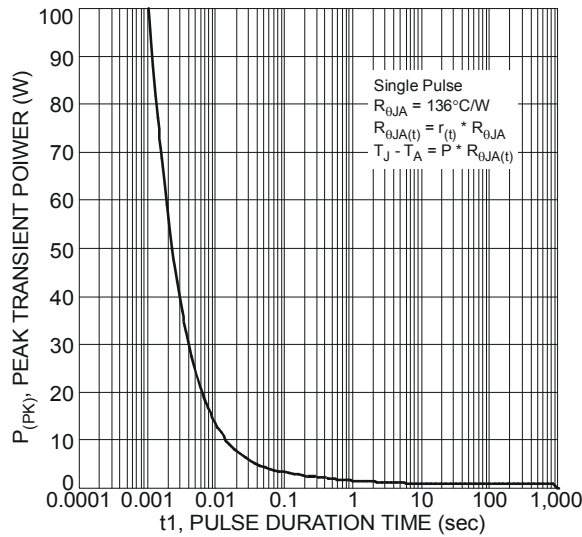

Figure 1 Single Pulse Maximum Power Dissipation

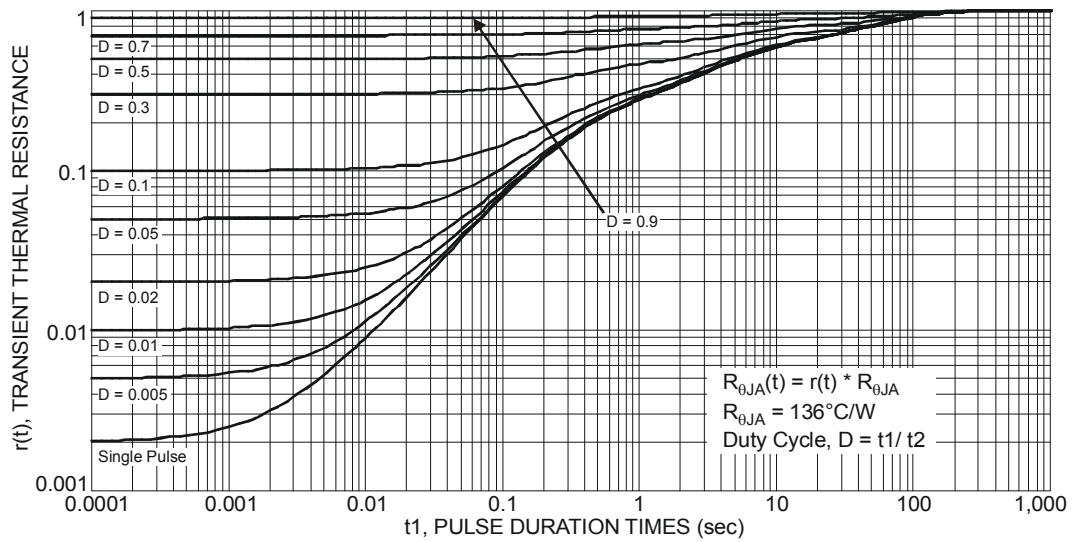

Figure 2 Transient Thermal Resistance

Electrical Characteristics (@ $T_A = +25^\circ\text{C}$, unless otherwise specified.)

Characteristic	Symbol	Min	Typ	Max	Unit	Test Condition
OFF CHARACTERISTICS						
Drain-Source Breakdown Voltage	BV_{DSS}	-40	—	—	V	$I_D = -250\mu\text{A}$, $V_{GS} = 0\text{V}$
Zero Gate Voltage Drain Current	I_{DSS}	—	—	-1.0	μA	$V_{DS} = -40\text{V}$, $V_{GS} = 0\text{V}$
Gate-Source Leakage	I_{GSS}	—	—	± 100	nA	$V_{GS} = \pm 20\text{V}$, $V_{DS} = 0\text{V}$
ON CHARACTERISTICS						
Gate Threshold Voltage	$V_{GS(th)}$	-0.8	-1.3	-1.8	V	$I_D = -250\mu\text{A}$, $V_{DS} = V_{GS}$
Static Drain-Source On-Resistance (Note 8)	$R_{DS(on)}$	—	18	25	m Ω	$V_{GS} = -10\text{V}$, $I_D = -3\text{A}$
			30	45		$V_{GS} = -4.5\text{V}$, $I_D = -3\text{A}$
Forward Transconductance (Notes 8 & 9)	g_{fs}	—	16.6	—	S	$V_{DS} = -5\text{V}$, $I_D = -3\text{A}$
Diode Forward Voltage (Note 8)	V_{SD}	—	-0.7	-1.0	V	$I_S = -1\text{A}$, $V_{GS} = 0\text{V}$
DYNAMIC CHARACTERISTICS (Note 9)						
Input Capacitance	C_{iss}	—	1643	—	pF	$V_{DS} = -20\text{V}$, $V_{GS} = 0\text{V}$ $f = 1\text{MHz}$
Output Capacitance	C_{oss}	—	179	—		
Reverse Transfer Capacitance	C_{rss}	—	128	—		
Gate Resistance	R_g	—	6.43	—	Ω	$V_{DS} = 0\text{V}$, $V_{GS} = 0\text{V}$, $f = 1\text{MHz}$
Total Gate Charge (Note 10)	Q_g	—	14.0	—	nC	$V_{GS} = -4.5\text{V}$ $V_{DS} = -20\text{V}$ $I_D = -3\text{A}$
Total Gate Charge (Note 10)	Q_g	—	33.7	—		
Gate-Source Charge (Note 10)	Q_{gs}	—	5.5	—		
Gate-Drain Charge (Note 10)	Q_{gd}	—	7.3	—		
Turn-On Delay Time (Note 10)	$t_{D(on)}$	—	6.9	—	ns	$V_{DD} = -20\text{V}$, $V_{GS} = -10\text{V}$ $I_D = -3\text{A}$
Turn-On Rise Time (Note 10)	t_r	—	14.7	—		
Turn-Off Delay Time (Note 10)	$t_{D(off)}$	—	53.7	—		
Turn-Off Fall Time (Note 10)	t_f	—	30.9	—		

- Notes:
 8. Measured under pulsed conditions. Pulse width $\leq 300\mu\text{s}$; duty cycle $\leq 2\%$
 9. For design aid only, not subject to production testing.
 10. Switching characteristics are independent of operating junction temperatures.

Typical Characteristics

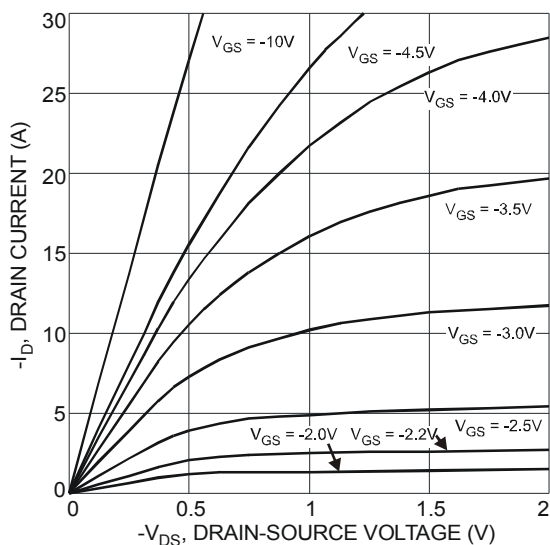

Figure 3 Typical Output Characteristic

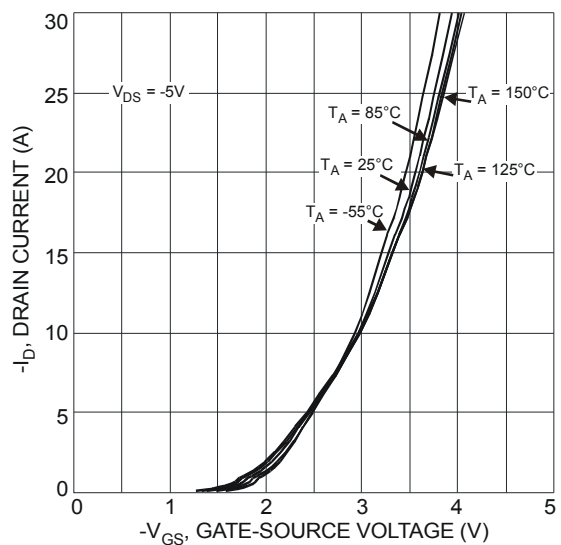

Figure 4 Typical Transfer Characteristic

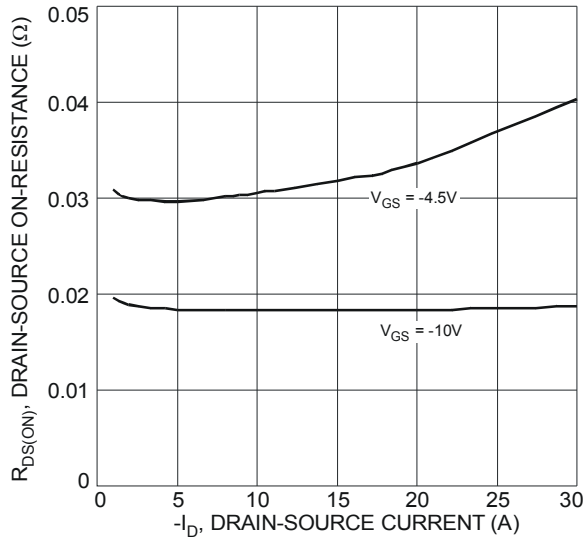

Figure 5 Typical On-Resistance vs. Drain Current and Gate Voltage

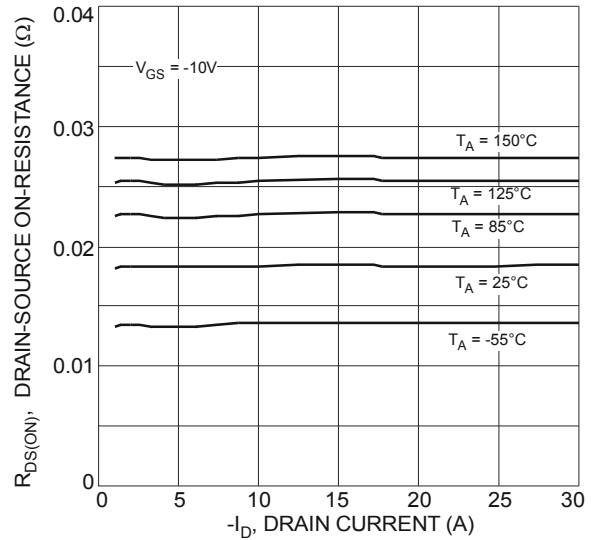

Figure 6 Typical On-Resistance vs. Drain Current and Temperature

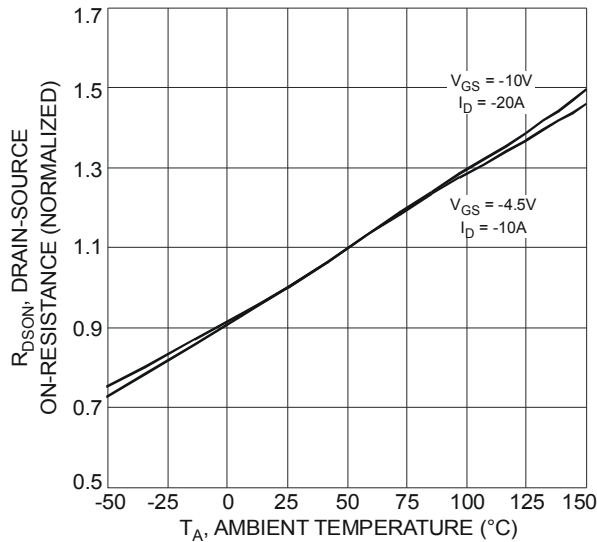

Figure 7 On-Resistance Variation with Temperature

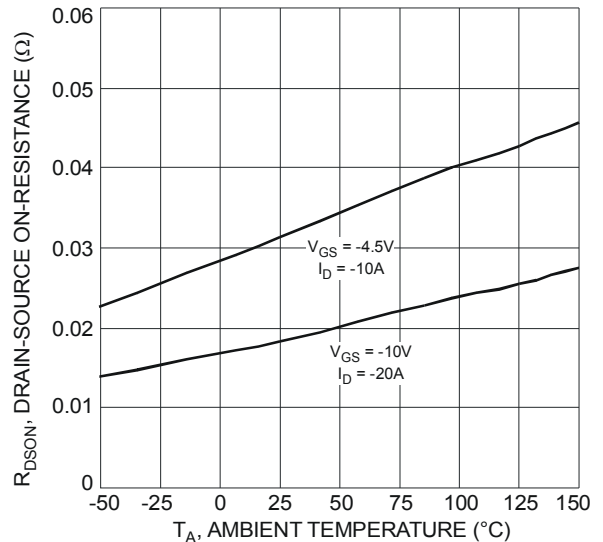

Figure 8 On-Resistance Variation with Temperature

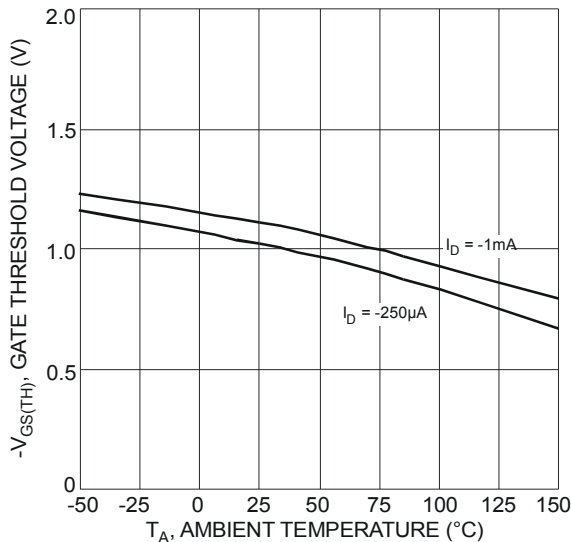

Figure 9 Gate Threshold Variation vs. Ambient Temperature

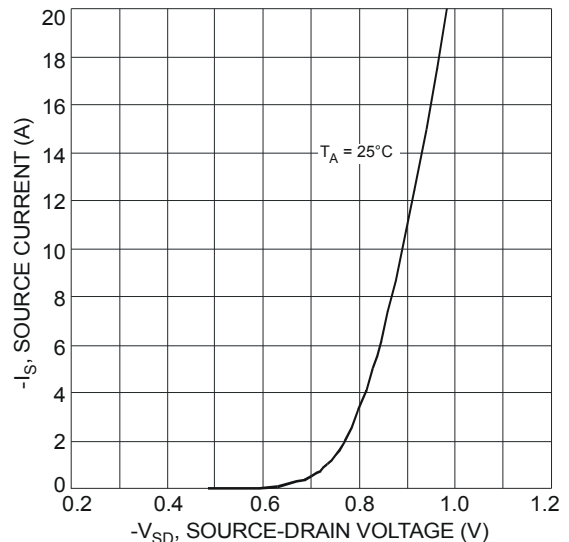

Figure 10 Diode Forward Voltage vs. Current

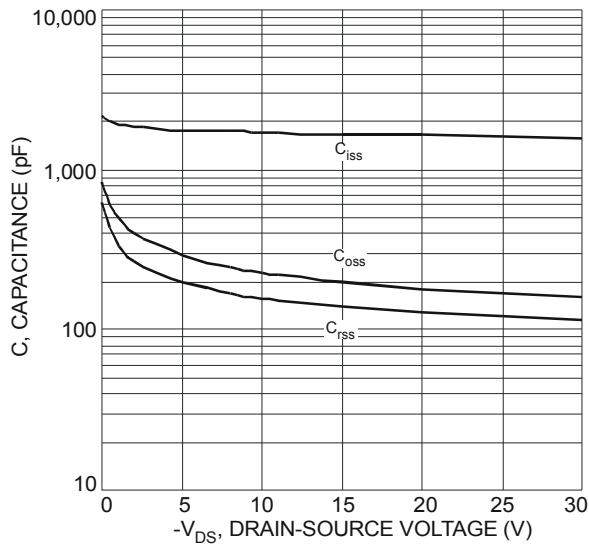

Figure 11 Typical Total Capacitance

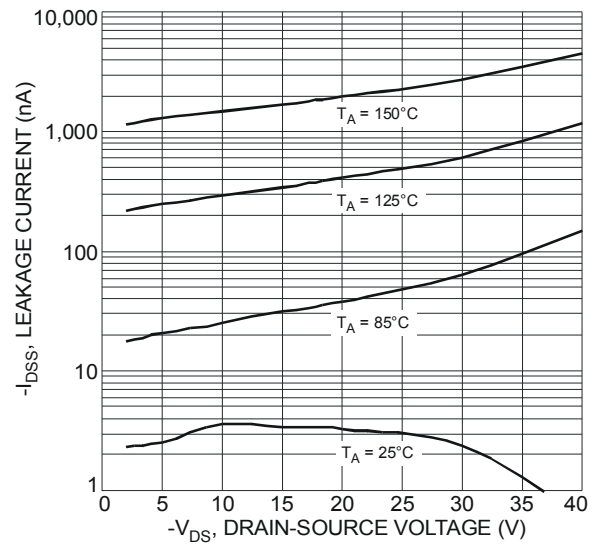

Figure 12 Typical Leakage Current vs. Drain-Source Voltage

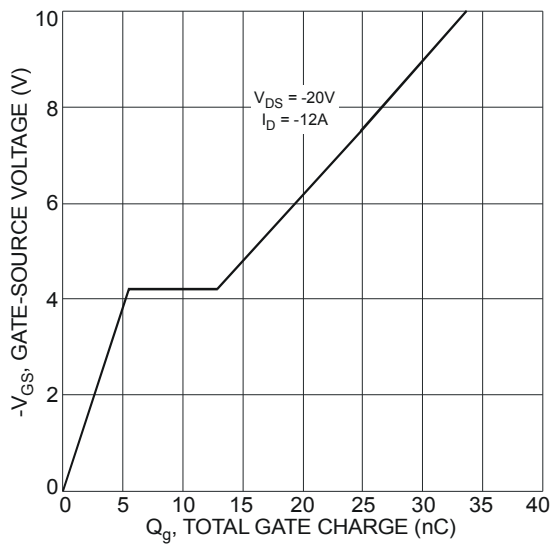
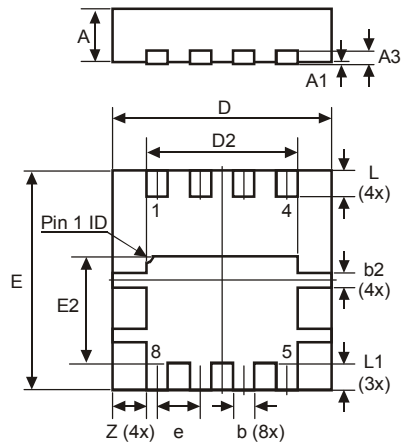

Figure 13 Gate-Charge Characteristics

Package Outline Dimensions

Please see AP02002 at <http://www.diodes.com/datasheets/ap02002.pdf> for latest version.



POWERDI [®] 3333-8			
Dim	Min	Max	Typ
D	3.25	3.35	3.30
E	3.25	3.35	3.30
D2	2.22	2.32	2.27
E2	1.56	1.66	1.61
A	0.75	0.85	0.80
A1	0	0.05	0.02
A3	-	-	0.203
b	0.27	0.37	0.32
b2	-	-	0.20
L	0.35	0.45	0.40
L1	-	-	0.39
e	-	-	0.65
Z	-	-	0.515
All Dimensions in mm			

Suggested Pad Layout

Please see AP02001 at <http://www.diodes.com/datasheets/ap02001.pdf> for the latest version.

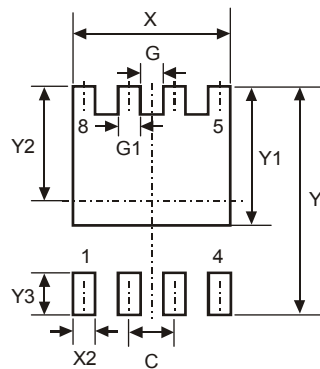

Dimensions	Value (in mm)
C	0.650
G	0.230
G1	0.420
Y	3.700
Y1	2.250
Y2	1.850
Y3	0.700
X	2.370
X2	0.420

IMPORTANT NOTICE

DIODES INCORPORATED MAKES NO WARRANTY OF ANY KIND, EXPRESS OR IMPLIED, WITH REGARDS TO THIS DOCUMENT, INCLUDING, BUT NOT LIMITED TO, THE IMPLIED WARRANTIES OF MERCHANTABILITY AND FITNESS FOR A PARTICULAR PURPOSE (AND THEIR EQUIVALENTS UNDER THE LAWS OF ANY JURISDICTION).

Diodes Incorporated and its subsidiaries reserve the right to make modifications, enhancements, improvements, corrections or other changes without further notice to this document and any product described herein. Diodes Incorporated does not assume any liability arising out of the application or use of this document or any product described herein; neither does Diodes Incorporated convey any license under its patent or trademark rights, nor the rights of others. Any Customer or user of this document or products described herein in such applications shall assume all risks of such use and will agree to hold Diodes Incorporated and all the companies whose products are represented on Diodes Incorporated website, harmless against all damages.

Diodes Incorporated does not warrant or accept any liability whatsoever in respect of any products purchased through unauthorized sales channel. Should Customers purchase or use Diodes Incorporated products for any unintended or unauthorized application, Customers shall indemnify and hold Diodes Incorporated and its representatives harmless against all claims, damages, expenses, and attorney fees arising out of, directly or indirectly, any claim of personal injury or death associated with such unintended or unauthorized application.

Products described herein may be covered by one or more United States, international or foreign patents pending. Product names and markings noted herein may also be covered by one or more United States, international or foreign trademarks.

This document is written in English but may be translated into multiple languages for reference. Only the English version of this document is the final and determinative format released by Diodes Incorporated.

LIFE SUPPORT

Diodes Incorporated products are specifically not authorized for use as critical components in life support devices or systems without the express written approval of the Chief Executive Officer of Diodes Incorporated. As used herein:

A. Life support devices or systems are devices or systems which:

1. are intended to implant into the body, or
2. support or sustain life and whose failure to perform when properly used in accordance with instructions for use provided in the labeling can be reasonably expected to result in significant injury to the user.

B. A critical component is any component in a life support device or system whose failure to perform can be reasonably expected to cause the failure of the life support device or to affect its safety or effectiveness.

Customers represent that they have all necessary expertise in the safety and regulatory ramifications of their life support devices or systems, and acknowledge and agree that they are solely responsible for all legal, regulatory and safety-related requirements concerning their products and any use of Diodes Incorporated products in such safety-critical, life support devices or systems, notwithstanding any devices- or systems-related information or support that may be provided by Diodes Incorporated. Further, Customers must fully indemnify Diodes Incorporated and its representatives against any damages arising out of the use of Diodes Incorporated products in such safety-critical, life support devices or systems.

Copyright © 2013, Diodes Incorporated

www.diodes.com



Компания «ЭлектроПласт» предлагает заключение долгосрочных отношений при поставках импортных электронных компонентов на взаимовыгодных условиях!

Наши преимущества:

- Оперативные поставки широкого спектра электронных компонентов отечественного и импортного производства напрямую от производителей и с крупнейших мировых складов;
- Поставка более 17-ти миллионов наименований электронных компонентов;
- Поставка сложных, дефицитных, либо снятых с производства позиций;
- Оперативные сроки поставки под заказ (от 5 рабочих дней);
- Экспресс доставка в любую точку России;
- Техническая поддержка проекта, помощь в подборе аналогов, поставка прототипов;
- Система менеджмента качества сертифицирована по Международному стандарту ISO 9001;
- Лицензия ФСБ на осуществление работ с использованием сведений, составляющих государственную тайну;
- Поставка специализированных компонентов (Xilinx, Altera, Analog Devices, Intersil, Interpoint, Microsemi, Aeroflex, Peregrine, Syfer, Eurofarad, Texas Instrument, Miteq, Cobham, E2V, MA-COM, Hittite, Mini-Circuits, General Dynamics и др.);

Помимо этого, одним из направлений компании «ЭлектроПласт» является направление «Источники питания». Мы предлагаем Вам помощь Конструкторского отдела:

- Подбор оптимального решения, техническое обоснование при выборе компонента;
- Подбор аналогов;
- Консультации по применению компонента;
- Поставка образцов и прототипов;
- Техническая поддержка проекта;
- Защита от снятия компонента с производства.



Как с нами связаться

Телефон: 8 (812) 309 58 32 (многоканальный)

Факс: 8 (812) 320-02-42

Электронная почта: org@eplast1.ru

Адрес: 198099, г. Санкт-Петербург, ул. Калинина, дом 2, корпус 4, литера А.