

Active infrared (area reflective) human detection sensor

MA MOTION SENSOR

FEATURES

1. Now even more miniature.

The new thin type cuts 35% from the thickness of the previous short type. Device installing is now easier than ever.

2. Certain detection unaffected by the reflectance of the object

The sensor can provide stable detection that is not affected by the condition (color or material of the clothing) or parts (skin, hair, etc.) of the object being monitored. (Reflectance 18% to 90%). Excellent performance even when the detection surface is dirty.

3. Only connecting DC power supply for operating

Built-in oscillation circuit type obviates the hitherto existing need for start signal input.

4. Use in adjacent positions is possible

These sensors can be located in adjacent positions, because the timing of the external trigger signals can be adjusted so that the beam frequency of each adjacent sensor will not interfere with the other.

APPLICATIONS

1. Water-based product market

- Automatic lighting of wash basin units
- Toilets

2. Stores and financial instructions

- Automatic doors
- Automatic lighting
- Cash dispensing machines
- Automatic teller machines
- Visitor detecting sensors

3. Amusement market

- Automatic lighting for game display

4. Medical field

- Non-contact switch

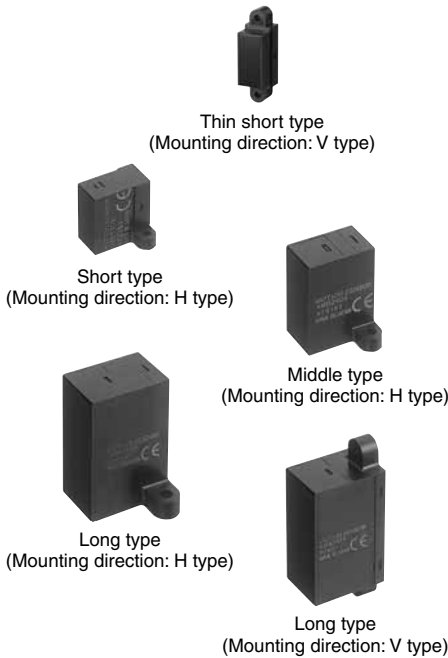

RoHS compliant

ORDERING INFORMATION

AM

A: Thin short type MA Motion sensor

BA: MA Motion sensor

Detection distance type (shape)

- 1: Short type
- 2: Middle type
- 3: Long type

Triggering function

- 1: External triggering type
- 4: Built-in oscillation circuit type (Internal trigger)

Classification by output method & mounting direction

- 0: NPN open collector/H type
- 5: NPN open collector/V type
- 6: PNP open collector/V type

Operating voltage

- 2: Free-ranging power type (5.5 to 27V DC)
- 9: 5V DC type (4.5 to 5.5V DC)

Rated detection distance

Part No.	cm inch																			
	02	03	04	05	06	07	08 (Middle type does not need 08)	09	10 (Short type does not need 10)	11	12	13	14	15	16	17	18	19	20 (Long type does not need 20)	
Thin short type	—	—	—	5 1.969	—	—	—	—	10 3.937	—	—	—	—	15 5.906	—	—	—	—	—	
Short type	—	—	—	5 1.969	6 2.362	7 2.756	8 3.150	9 3.543	10 3.937	—	—	—	—	—	—	—	—	—	—	
Middle type	20 7.874	30 11.811	40 15.748	50 19.685	60 23.622	70 27.559	80 31.496	—	—	—	—	—	—	—	—	—	—	—	—	
Long type	—	30 11.811	40 15.748	50 19.685	60 23.622	70 27.559	80 31.496	90 35.433	100 39.37	110 43.307	120 47.244	130 51.181	140 55.118	150 59.055	160 62.992	170 66.929	180 70.866	190 74.803	200 78.74	

MA Motion Sensor (AMA1, AMBA1, 2, 3)

PRODUCT TYPES

1. Detection distance type (distance limited)

1) Thin short type (V type)

Operating voltage	Output method	Rated detection distance	Built-in oscillation circuit type		External triggering type	
			Part No.		Part No.	
4.5 to 5.5 V DC	NPN open collector output	5 cm 1.969 inch	AMA145905		AMA115905	
		10 cm 3.937 inch	AMA1459		AMA1159	
		15 cm 5.906 inch	AMA145915		AMA115915	
	PNP open collector output	5 cm 1.969 inch	AMA146905		AMA116905	
		10 cm 3.937 inch	AMA1469		AMA1169	
		15 cm 5.906 inch	AMA146915		AMA116915	

Standard packing: Carton: 20 pcs.; Case: 200 pcs.

Note: If you plan to use multiple sensors side-by-side, or you wish to keep the current consumption small, inquire for details about external trigger type, which is suitable for such applications.

2) Short type (H type)

Rated operating voltage	Rated detection distance	Mounting direction: H type			
		Short type			
		Built-in oscillation circuit type		External triggering type	
		Part No.		Part No.	
4.5 to 5.5 V DC	5 cm 1.969 inch	AMBA140905		AMBA110905	
	6 cm 2.362 inch	AMBA140906		AMBA110906	
	7 cm 2.756 inch	AMBA140907		AMBA110907	
	8 cm 3.150 inch	AMBA140908		AMBA110908	
	9 cm 3.543 inch	AMBA140909		AMBA110909	
	10 cm 3.937 inch	AMBA1409		AMBA1109	
5.5 to 27 V DC	5 cm 1.969 inch	AMBA140205		AMBA110205	
	6 cm 2.362 inch	AMBA140206		AMBA110206	
	7 cm 2.756 inch	AMBA140207		AMBA110207	
	8 cm 3.150 inch	AMBA140208		AMBA110208	
	9 cm 3.543 inch	AMBA140209		AMBA110209	
	10 cm 3.937 inch	AMBA1402		AMBA1102	

Standard packing: Carton: 20 pcs.; Case: 200 pcs.

Note: If you plan to use multiple sensors side-by-side, or you wish to keep the current consumption small, inquire for details about external trigger type, which is suitable for such applications.

3) Middle type (H type)

Rated operating voltage	Rated detection distance	Mounting direction: H type			
		Middle type			
		Built-in oscillation circuit type		External triggering type	
		Part No.		Part No.	
4.5 to 5.5 V DC	20 cm 7.874 inch	AMBA240902		AMBA210902	
	30 cm 11.811 inch	AMBA240903		AMBA210903	
	40 cm 15.748 inch	AMBA240904		AMBA210904	
	50 cm 19.685 inch	AMBA240905		AMBA210905	
	60 cm 23.622 inch	AMBA240906		AMBA210906	
	70 cm 27.559 inch	AMBA240907		AMBA210907	
	80 cm 31.496 inch	AMBA2409		AMBA2109	
5.5 to 27 V DC	20 cm 7.874 inch	AMBA240202		AMBA210202	
	30 cm 11.811 inch	AMBA240203		AMBA210203	
	40 cm 15.748 inch	AMBA240204		AMBA210204	
	50 cm 19.685 inch	AMBA240205		AMBA210205	
	60 cm 23.622 inch	AMBA240206		AMBA210206	
	70 cm 27.559 inch	AMBA240207		AMBA210207	
	80 cm 31.496 inch	AMBA2402		AMBA2102	

Standard packing: Carton: 20 pcs.; Case: 200 pcs.

Note: If you plan to use multiple sensors side-by-side, or you wish to keep the current consumption small, inquire for details about external trigger type, which is suitable for such applications.

MA Motion Sensor (AMA1, AMBA1, 2, 3)

4) Long type

Rated operating voltage	Rated detection distance	Mounting direction: H type		Mounting direction: V type	
		Long type			
		Built-in oscillation circuit type	External triggering type	Built-in oscillation circuit type	External triggering type
		Part No.	Part No.	Part No.	Part No.
4.5 to 5.5 V DC	30 cm 11.811 inch	AMBA340903	AMBA310903	AMBA345903	AMBA315903
	40 cm 15.748 inch	AMBA340904	AMBA310904	AMBA345904	AMBA315904
	50 cm 19.685 inch	AMBA340905	AMBA310905	AMBA345905	AMBA315905
	60 cm 23.622 inch	AMBA340906	AMBA310906	AMBA345906	AMBA315906
	70 cm 27.559 inch	AMBA340907	AMBA310907	AMBA345907	AMBA315907
	80 cm 31.496 inch	AMBA340908	AMBA310908	AMBA345908	AMBA315908
	90 cm 35.433 inch	AMBA340909	AMBA310909	AMBA345909	AMBA315909
	100 cm 39.370 inch	AMBA340910	AMBA310910	AMBA345910	AMBA315910
	110 cm 43.307 inch	AMBA340911	AMBA310911	AMBA345911	AMBA315911
	120 cm 47.244 inch	AMBA340912	AMBA310912	AMBA345912	AMBA315912
	130 cm 51.181 inch	AMBA340913	AMBA310913	AMBA345913	AMBA315913
	140 cm 55.118 inch	AMBA340914	AMBA310914	AMBA345914	AMBA315914
	150 cm 59.055 inch	AMBA340915	AMBA310915	AMBA345915	AMBA315915
	160 cm 62.992 inch	AMBA340916	AMBA310916	AMBA345916	AMBA315916
	170 cm 66.929 inch	AMBA340917	AMBA310917	AMBA345917	AMBA315917
	180 cm 70.866 inch	AMBA340918	AMBA310918	AMBA345918	AMBA315918
190 cm 74.803 inch	AMBA340919	AMBA310919	AMBA345919	AMBA315919	
200 cm 78.740 inch	AMBA3409	AMBA3109	AMBA3459	AMBA3159	
5.5 to 27 V DC	30 cm 11.811 inch	AMBA340203	AMBA310203	AMBA345203	AMBA315203
	40 cm 15.748 inch	AMBA340204	AMBA310204	AMBA345204	AMBA315204
	50 cm 19.685 inch	AMBA340205	AMBA310205	AMBA345205	AMBA315205
	60 cm 23.622 inch	AMBA340206	AMBA310206	AMBA345206	AMBA315206
	70 cm 27.559 inch	AMBA340207	AMBA310207	AMBA345207	AMBA315207
	80 cm 31.496 inch	AMBA340208	AMBA310208	AMBA345208	AMBA315208
	90 cm 35.433 inch	AMBA340209	AMBA310209	AMBA345209	AMBA315209
	100 cm 39.370 inch	AMBA340210	AMBA310210	AMBA345210	AMBA315210
	110 cm 43.307 inch	AMBA340211	AMBA310211	AMBA345211	AMBA315211
	120 cm 47.244 inch	AMBA340212	AMBA310212	AMBA345212	AMBA315212
	130 cm 51.181 inch	AMBA340213	AMBA310213	AMBA345213	AMBA315213
	140 cm 55.118 inch	AMBA340214	AMBA310214	AMBA345214	AMBA315214
	150 cm 59.055 inch	AMBA340215	AMBA310215	AMBA345215	AMBA315215
	160 cm 62.992 inch	AMBA340216	AMBA310216	AMBA345216	AMBA315216
	170 cm 66.929 inch	AMBA340217	AMBA310217	AMBA345217	AMBA315217
	180 cm 70.866 inch	AMBA340218	AMBA310218	AMBA345218	AMBA315218
190 cm 74.803 inch	AMBA340219	AMBA310219	AMBA345219	AMBA315219	
200 cm 78.740 inch	AMBA3402	AMBA3102	AMBA3452	AMBA3152	

Standard packing: Carton: 20 pcs.; Case: 200 pcs.

Note: If you plan to use multiple sensors side-by-side, or you wish to keep the current consumption small, inquire for details about external trigger type, which is suitable for such applications.

RATING

1. Detection performance

1) Thin short type (Measuring conditions: ambient temp.: 25°C 77°F; operating voltage: 5 V DC)

Items		Thin short type			Measured conditions
		5 cm 1.969 inch	10 cm 3.937 inch	15 cm 3.937 inch	
Rated detection distance	Minimum	45 mm	90 mm	135 mm	with a standard reflection board*1
	Typical	1.772 inch 50 mm	3.543 inch 100 mm	5.315 inch 150 mm	
	Maximum	1.969 inch 55 mm 2.165 inch	3.937 inch 110 mm 4.331 inch	5.906 inch 165 mm 6.496 inch	
Measuring tolerance	Typical	10%	25%	35%	Reflection rate: 90 to 18%
Usable ambient brightness (Resistance to ambient light)*2	Brightness of sensor surface	30,000 lx			See the drawing (Fig. 1) on the next page.
	Brightness of reflection surface	24,000 lx			

Notes: *1. Ambient brightness: 500 lx

*2. Install so that light from direct light sources does not enter the sensor (within 30° of the sensor light beam).

Indicates brightness detectible enough for sensor operation.

MA Motion Sensor (AMA1, AMBA1, 2, 3)

2) Short type (Measuring conditions: ambient temp.: 25°C 77°F; operating voltage: 5 V DC type 5V, Free-ranging power type 24V DC)

Items		Short type*1						Measured conditions
		5 cm 1.969 inch	6 cm 2.362 inch	7 cm 2.756 inch	8 cm 3.150 inch	9 cm 3.543 inch	10 cm 3.937 inch	
Rated detection distance	Minimum	45 mm	54 mm	63 mm	72 mm	81 mm	90 mm	with a standard reflection board
	Typical	1.772 inch 50 mm	2.126 inch 60 mm	2.480 inch 70 mm	2.835 inch 80 mm	3.189 inch 90 mm	3.543 inch 100 mm	
	Maximum	1.969 inch 55 mm	2.362 inch 66 mm	2.756 inch 77 mm	3.150 inch 88 mm	3.543 inch 99 mm	3.937 inch 110 mm	
Measuring tolerance	Typical	10%		15%	20%		25%	Reflection rate: 90 to 18%
Usable ambient brightness (Resistance to ambient light)*2	Brightness of sensor surface	Maximum						See the drawing (Fig. 1) on the next page.
	Brightness of reflection surface	Maximum						

Notes: *1. After receipt of order, average rated detection distance to 15 cm 5.906 inch is possible. Please inquire.

*2. Install so that light from direct light sources does not enter the sensor (within 30° of the sensor light beam).

3) Middle type (Measuring conditions: ambient temp.: 25°C 77°F; operating voltage: 5 V DC type 5V, Free-ranging power type 24V DC)

Items		Middle type*1						Measured conditions	
		20 cm 7.874 inch	30 cm 11.811 inch	40 cm 15.748 inch	50 cm 19.685 inch	60 cm 23.622 inch	70 cm 27.559 inch		80 cm 31.496 inch
Rated detection distance	Minimum	190 mm	285 mm	380 mm	475 mm	570 mm	665 mm	760 mm	with a standard reflection board
	Typical	7.480 inch 200 mm	11.220 inch 300 mm	14.961 inch 400 mm	18.701 inch 500 mm	22.441 inch 600 mm	26.181 inch 700 mm	29.921 inch 800 mm	
	Maximum	7.874 inch 210 mm	11.811 inch 315 mm	15.748 inch 420 mm	19.685 inch 525 mm	23.622 inch 630 mm	27.559 inch 735 mm	31.496 inch 840 mm	
Measuring tolerance	Typical	3%			5%		10%		Reflection rate: 90 to 18%
Usable ambient brightness (Resistance to ambient light)*2	Brightness of sensor surface	Maximum						See the drawing (Fig. 1) on the next page.	
	Brightness of reflection surface	Maximum							

Notes: *1. After receipt of order, average rated detection distance to 110 cm 43.307 inch is possible. Please inquire.

*2. Install so that light from direct light sources does not enter the sensor (within 30° of the sensor light beam).

4) Long type (Measuring conditions: ambient temp.: 25°C 77°F; operating voltage: 5 V DC type 5V, Free-ranging power type 24V DC)

Items		Long type								Measured conditions	
		30 cm 11.811 inch	40 cm 15.748 inch	50 cm 19.685 inch	60 cm 23.622 inch	70 cm 27.559 inch	80 cm 31.496 inch	90 cm 35.433 inch	100 cm 39.37 inch		110 cm 43.307 inch
Rated detection distance	Minimum	285 mm	380 mm	475 mm	570 mm	665 mm	760 mm	855 mm	950 mm	1045 mm	with a standard reflection board
	Typical	11.220 inch 300 mm	14.961 inch 400 mm	18.701 inch 500 mm	22.441 inch 600 mm	26.181 inch 700 mm	29.921 inch 800 mm	33.661 inch 900 mm	37.402 inch 1000 mm	41.142 inch 1100 mm	
	Maximum	11.811 inch 315 mm	15.748 inch 420 mm	19.685 inch 525 mm	23.622 inch 630 mm	27.559 inch 735 mm	31.496 inch 840 mm	35.433 inch 945 mm	39.37 inch 1050 mm	43.307 inch 1155 mm	
Measuring tolerance	Typical	3%				5%				Reflection rate: 90 to 18%	
Usable ambient brightness (Resistance to ambient light)*	Brightness of sensor surface	Maximum								See the drawing (Fig. 1) on the next page.	
	Brightness of reflection surface	Maximum									

Items		Long type								Measured conditions	
		120 cm 47.244 inch	130 cm 51.181 inch	140 cm 55.118 inch	150 cm 59.055 inch	160 cm 62.992 inch	170 cm 66.929 inch	180 cm 70.866 inch	190 cm 74.803 inch		200 cm 78.74 inch
Rated detection distance	Minimum	1140 mm	1235 mm	1330 mm	1425 mm	1520 mm	1615 mm	1710 mm	1805 mm	1900 mm	with a standard reflection board
	Typical	44.882 inch 1200 mm	48.622 inch 1300 mm	52.362 inch 1400 mm	56.102 inch 1500 mm	59.842 inch 1600 mm	63.583 inch 1700 mm	67.323 inch 1800 mm	71.063 inch 1900 mm	74.803 inch 2000 mm	
	Maximum	47.244 inch 1260 mm	51.181 inch 1365 mm	55.118 inch 1470 mm	59.055 inch 1575 mm	62.992 inch 1680 mm	66.929 inch 1785 mm	70.866 inch 1890 mm	74.803 inch 1995 mm	78.74 inch 2100 mm	
Measuring tolerance	Typical	5%	10%			15%				Reflection rate: 90 to 18%	
Usable ambient brightness (Resistance to ambient light)*	Brightness of sensor surface	Maximum								See the drawing (Fig. 1) on the next page.	
	Brightness of reflection surface	Maximum									

Note: * Install so that light from direct light sources does not enter the sensor (within 30° of the sensor light beam).

MA Motion Sensor (AMA1, AMBA1, 2, 3)

- For thin short type:
Standard reflection board: 150 mm 5.906 inch square area, 90% reflection rate.
- For short type:
Standard reflection board: 100 mm 3.937 inch square area, 90% reflection rate.
- For middle type:
Standard reflection board: 200 mm 7.874 inch square area, 90% reflection rate.
- For long type:
Standard reflection board: 500 mm 19.685 inch square area, 90% reflection rate.

Notes: 1. Detecting an object within the maximum preset detection distance.

$$2. \text{Distance deviation} = \frac{a-b}{a} \times 100 (\%)$$

(a: detection distance of detection target with reflectance of 90%.
b: detection distance of standard detection target with reflectance of 18%.)

<Fig. 1>
[Brightness of sensor surface]



Note: Light from direct light sources (sunlight, strobe light, inverter illumination, reflected light from glass or mirrors etc.) that enters the sensor from within the prohibited range can cause the sensor to operate erroneously.

[Brightness of reflection surface]

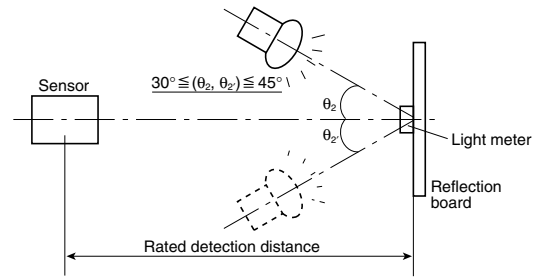

2. Absolute maximum rating (Measuring condition: ambient temp.: 25°C 77°F)

Items	Type	Absolute maximum rating			
		Built-in oscillation circuit type		External triggering type	
		5 V DC type	Free-ranging power type	5 V DC type	Free-ranging power type
Power supply voltage		-0.3 to 6 V DC	-0.3 to 30 V DC	-0.3 to 6 V DC	-0.3 to 30 V DC
Output dielectric strength		30 V		30 V	
Output flow current		100 mA		10 mA*	
Usable ambient temperature		-25 to +75°C +5 to +131°F (No freezing)		-25 to +75°C +5 to +131°F (No freezing)	
Storage temperature		-30 to +85°C -4 to +176°F		-30 to +85°C -4 to +176°F	

Note: * Thin short type is only: 100 mA

3. Electrical characteristics

(Measuring conditions: ambient temp.: 25°C 77°F; operating voltage: 5 V DC type =5V DC, free-ranging power type =24V DC)

1) Built-in oscillation circuit type

Items	Symbol	Thin short type*		Short type	Middle type	Long type	Measured conditions
		NPN output type	PNP output type				
Rated operating voltage	Minimum	5V DC type: 4.5V/Free-ranging power type: 5.5V					
	Typical	—					
	Maximum	5V DC type: 5.5V/Free-ranging power type: 27V					
Average current consumption (Iout = 0 mA)	No detection	Minimum	—				
		Typical	4.5mA	5V DC type: 4.5mA/Free-ranging power type: 5.6mA			
		Maximum	6.2mA	5V DC type: 6.2mA/Free-ranging power type: 7.8mA			
	Detection	Minimum	—				
		Typical	7.0mA	11.0mA			5V DC type: 7.0mA/Free-ranging power type: 9.1mA
		Maximum	11.2mA	15.2mA			5V DC type: 11.2mA/Free-ranging power type: 14.2mA
Measuring cycle	Minimum	T	8ms/cycle				
Output characteristics	Remain voltage	Maximum	Vr	1 V DC	1.2 V DC	1 V DC	I _t = 100 mA
	Leakage current	Maximum	I _l	5μA		3μA	V = 30V

Note: * The thin short type is only available for 5V DC.

MA Motion Sensor (AMA1, AMBA1, 2, 3)

2) External triggering type (trigger conditions: trigger pulse width = 20μs and trigger synchronization = 5ms)

Items	Symbol	Thin short type Note 1		Short type	Middle type	Long type	Measured conditions	
		NPN output type	PNP output type					
Rated operating voltage	Minimum	5V DC type: 4.5V/Free-ranging type: 5.5V						
	Typical	—						
	Maximum	5V DC type: 5.5V/Free-ranging type: 27V						
Average current consumption	Without trigger input	Output OFF	Minimum	—			Note 2: *b	
			Typical	—				
			Maximum	—				
		Output ON	Minimum	—				Note 2: *d
			Typical	0.1m	5V DC type: 0.1mA/Free-ranging type: 1.0mA			
			Maximum	0.3m	5V DC type: 0.3mA/Free-ranging type: 1.8mA			
	With trigger input	Output OFF	Minimum	—			Note 2: *a	
			Typical	2.2mA	5V DC type: 2.2mA/Free-ranging type: 3.1mA			
			Maximum	6.2mA	5V DC type: 6.2mA/Free-ranging type: 7.2mA			
		Output ON	Minimum	—				Note 2: *c
			Typical	4.2mA	6.2mA	5V DC type: 2.4mA/Free-ranging type: 3.3mA		
			Maximum	8.2mA	12.5mA	5V DC type: 8.2mA/Free-ranging type: 9.3mA		
Measuring cycle (Trigger interval)		Minimum	Tt				5ms/cycle	
External trigger	Pulse width	Minimum	Tw				20μs	
		Maximum					1/2Tt	
	Level	Maximum	V _{TL}				0.8V	
		Minimum	V _{TH}				3V	
Response performance: time from trigger pulse fall to detection output		Maximum	Tr				5ms	
Output characteristics	Remain voltage	Maximum	Vr	1 V DC	1.2 V DC	1 V	I = 10 mA	
	Leakage current	Maximum	I _l	5μA		3μA	V = 30 mA	

Notes: 1. The thin short type is only available for 5V DC.

2. The ratio between the 4 operating modes (*a to *d) depends on the external trigger period and detector time, and the current consumption corresponds with this varying ratio.



3. A high level is established in the open state due to pull-up by the internal circuit. (Refer to the connector wiring diagram.)

4. The output transistor is open collector.

The output transistor is turned ON by the sensor detection status and turned OFF by its non-detection status.



TIMING CHART

1. Built-in oscillation circuit type



Notes: 1. Circuit stability time : Max. 12 ms

2. During the time taken for the circuit to stabilize after the power is turned on, the ON/OFF status of the output transistor is not determined by whether the sensor is in the detection status or non-detection status.

2. External triggering type



Note: The sensor recognizes at the $V_{TH} \rightarrow V_{TL}$ edge of an external trigger that the external trigger has been input.

- Notes: 1. Circuit stability time: Max. 12 ms
2. During the time taken for the circuit to stabilize after the power is turned on, the ON/OFF status of the output transistor is not determined by whether the sensor is in the detection status or non-detection status.

HOW TO USE

1. Wiring diagram of connector



- Notes: 1. The output transistor has an open collector structure.
- Detection status: Output transistor ON (connected to GND)
 - Non-detection status: Output transistor OFF (open state)
2. The status of the external trigger input is as follows:
- Open at the high level
 - GND (less than 0.8V) at the low level
- Under no circumstances must a high-level voltage be applied.
3. To maintain the power supply superimposed noise performance, be certain to connect a capacitor (33µF or more) to the sensor power supply input terminal in order to stabilize the power supply voltage.

MA Motion Sensor (AMA1, AMBA1, 2, 3)

REFERENCE DATA

Operating region characteristics

- How to interpret the graph

Example: Operating area of the Short Type with rated detection distance of 8 cm 3.150 inch.



Operating area within the dotted lines

Objects that enter the entire area are detected.



Note: If only part of the object is in the detection area, it is not detected.

Operating area within the solid lines

Objects that even partially enter the area are detected.



1.-(1) Thin short type (AMA1□□□□□) Short type (AMBA1□□□□□)

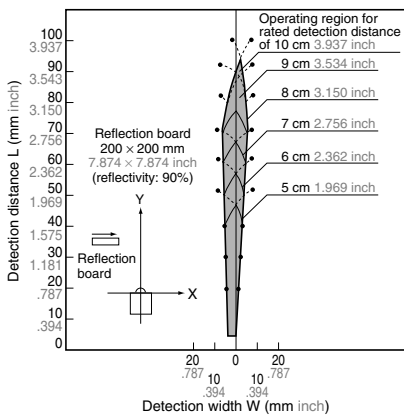

1.-(2) Middle type (AMBA2□□□□□)

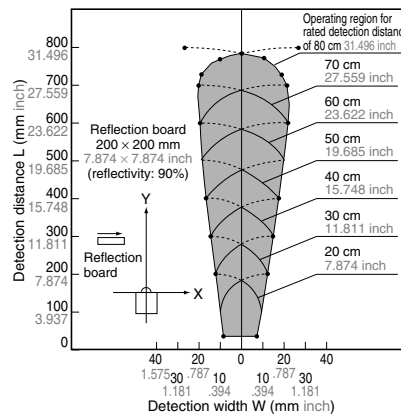

1.-(3) Long type (AMBA3□□□□□)



DIMENSIONS (mm/inch)

The CAD data of the products with a **CAD Data** mark can be downloaded from: <http://industrial.panasonic.com/ac/e/>

(Common to the Built-in oscillation circuit type and External triggering type)

1. Thin short type (V type)

CAD Data

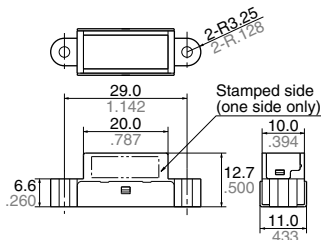

*Rear side connector protrusion: Max. 0.4mm

2. Short type (H type)

CAD Data



3. Middle type (H type)

CAD Data



MA Motion Sensor (AMA1, AMBA1, 2, 3)

4. Long type (H type)

CAD Data

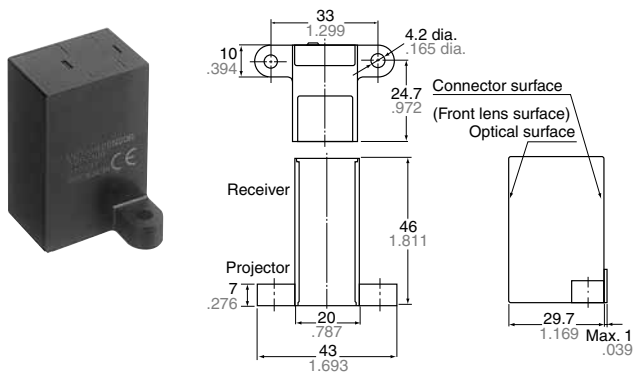

5. Long type (V type)

CAD Data

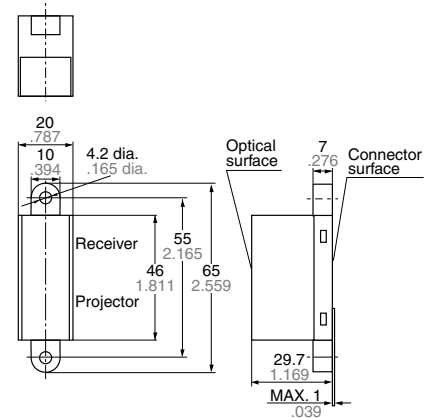

WIRING DIAGRAM (Connector surface view)

1. Thin short type (V type)



2. Short type (H type)



3. Middle type (H type)



4. Long type (H type)

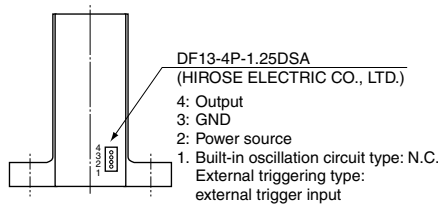

5. Long type (V type)

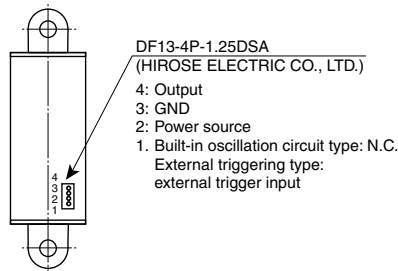

OPTIONS (mm inch)

1. Connector with cable (for Short, Middle and Long type)

AMV9003

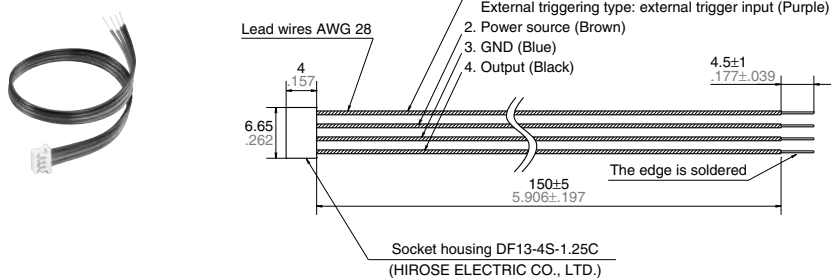

Note: Mistaken cable assembly can cause damage to the internal circuits, so please check the power cord before switching ON. (Particular care must be taken as to avoid reverse connection of the power.)

2. Connector with cable (for Thin short type)

AMV9002

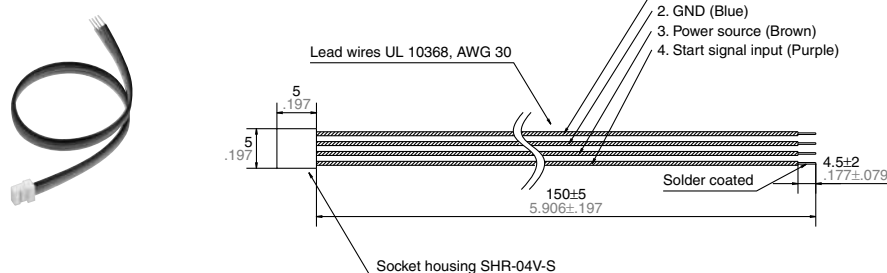

MA Motion Sensor (AMA1, AMBA1, 2, 3)

NOTES

1. Environment

- 1) Avoid using the sensor in environments containing excessive amounts of steam, dust, corrosive gas, or where organic solvents are present.
- 2) When the sensor is used in noisy environments, implement a countermeasure such as connecting a capacitor (Min. 33 μ F) across the power input terminals. Only use the sensor after verifying actual operation.

2. Wiring

- 1) Check all wiring before applying power. Incorrect wiring may damage the internal circuit (in particular, check that the connection to the power supply is not reversed.)
- 2) Avoid excessive removing and replacing of the connector.

3. Detector surface (Optical surface)

- 1) Keep the detector surface clean. Excessive dust or dirt on the detector surface will deteriorate the sensing performance.
- 2) Do not allow condensation or freezing to occur on the surface of the sensor. If condensation or freezing does occur at low temperatures, the sensor may not detect objects correctly.
- 3) This product is designed to detect the existence of human bodies. The sensor may not detect properly or the detection distance may become unstable if the objects consist of a low reflective material (e.g., an object coated with black rubber, etc.) or of a highly reflective material (e.g., mirror, glass, coated paper, etc.).

- 4) The front surface of the lens and case are made of polycarbonate resin and can withstand water, alcohol, oils, salts and weak acids. Other fluids such as alkalines, aromatic hydrocarbons and halogenated hydrocarbons may melt or swell the lens and case, please do not have such fluids touch the lens and case.
- 5) If you use the sensor with a cover or filter connected to the front of the sensor, the sensor may detect the cover itself, the detection distance can change, and unstable operation can result.
- 6) If this sensor is used in a position where it will be facing another sensor, light will be received from the other sensor which can cause mutual interference and malfunction. Therefore, please verify the installation conditions before use.

- 7) When multiple sensors are to be used side by side, please verify that there will be no mutual interference by installing them with the proper spacing, depending on the type as shown below.

Model number	Sensor spacing
AMBA1 series	5 cm 1.969 inch
AMA1 series	8 cm 3.150 inch
AMBA2 series	10 cm 3.937 inch
AMBA3 series	20 cm 7.874 inch

4. Recommended installation procedure

Install the sensor so that it is orientated correctly in relation to the pass directions of the target objects as shown in the figure below.

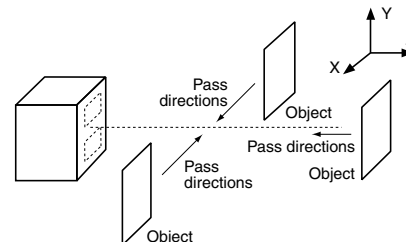

* → stands for pass direction of the target object.

For the general precautions, refer to "NOTES FOR USING MOTION SENSOR (Common)" on next page.



Компания «ЭлектроПласт» предлагает заключение долгосрочных отношений при поставках импортных электронных компонентов на взаимовыгодных условиях!

Наши преимущества:

- Оперативные поставки широкого спектра электронных компонентов отечественного и импортного производства напрямую от производителей и с крупнейших мировых складов;
- Поставка более 17-ти миллионов наименований электронных компонентов;
- Поставка сложных, дефицитных, либо снятых с производства позиций;
- Оперативные сроки поставки под заказ (от 5 рабочих дней);
- Экспресс доставка в любую точку России;
- Техническая поддержка проекта, помощь в подборе аналогов, поставка прототипов;
- Система менеджмента качества сертифицирована по Международному стандарту ISO 9001;
- Лицензия ФСБ на осуществление работ с использованием сведений, составляющих государственную тайну;
- Поставка специализированных компонентов (Xilinx, Altera, Analog Devices, Intersil, Interpoint, Microsemi, Aeroflex, Peregrine, Syfer, Eurofarad, Texas Instrument, Miteq, Cobham, E2V, MA-COM, Hittite, Mini-Circuits, General Dynamics и др.);

Помимо этого, одним из направлений компании «ЭлектроПласт» является направление «Источники питания». Мы предлагаем Вам помощь Конструкторского отдела:

- Подбор оптимального решения, техническое обоснование при выборе компонента;
- Подбор аналогов;
- Консультации по применению компонента;
- Поставка образцов и прототипов;
- Техническая поддержка проекта;
- Защита от снятия компонента с производства.



Как с нами связаться

Телефон: 8 (812) 309 58 32 (многоканальный)

Факс: 8 (812) 320-02-42

Электронная почта: org@eplast1.ru

Адрес: 198099, г. Санкт-Петербург, ул. Калинина, дом 2, корпус 4, литера А.