



## FEATURES

- Built-in CTs provide true-rms values of complex waveforms
- Perfect for measuring AC current in IT applications
- Five ranges measure: 0-0.2A, 0-2A, 0-20A, 0-30A and 0-50A
- 50A models features a split-core CT for easy installation
- Self-powered from 85-140Vac or 170-264Vac
- Large, easy-to-read, red LED display with 0.37" digits
- Reliable single-board construction
- Digital replacement for analog meters
- UL and CSA recognized components

Murata Power Solution's new ACA-20RM Series are the world's first digital ac-ammeters to incorporate a built-in current transformer (CT) to directly measure the true-rms value of complex, non-sinusoidal ac currents from 2 to 50A – no bulky and expensive 5A “donut” CTs are required! Operation and setup is straightforward: simply pass the load-carrying wire through the on-board CT, apply power, and the ammeter is fully operational.

Five input ranges measure 0-0.2 amps (0.1mA resolution), 0-2 amps (0.001A resolution), 0-20 amps (0.01A resolution), 0-30 amps (0.1A resolution) or 0-50 amps (0.1A resolution). The 50A model features an oversized split-core current transformer that easily accommodates wires sizes up to 4 AWG (21.2mm<sup>2</sup>). Two power supply options are available: 85-140V (47-63Hz), and 170-264V (47-63Hz).

All models are totally self-contained; no external components are required. Power consumption from a nominal 120V or 220V ac supply is less than 50mA. And, precision auto-zeroing circuitry, super-stable components, and an rms-to-dc converter circuit combine to achieve excellent performance when measuring the complex, non-sinusoidal, ac currents found in today's computer/telecom equipment.

ACA-20RM Series ammeters feature full-size, 0.37" (9.4mm) high, 3½ digit, bright red LED-displays and a built-in bezel/filter assembly that features metal fasteners. They are panel-cutout compatible with MPS's DMS-20 Series of ac voltage and frequency monitors, making ACA-20RM ammeters perfect replacements for older, less reliable, analog panel meters in today's sophisticated IT instrumentation.

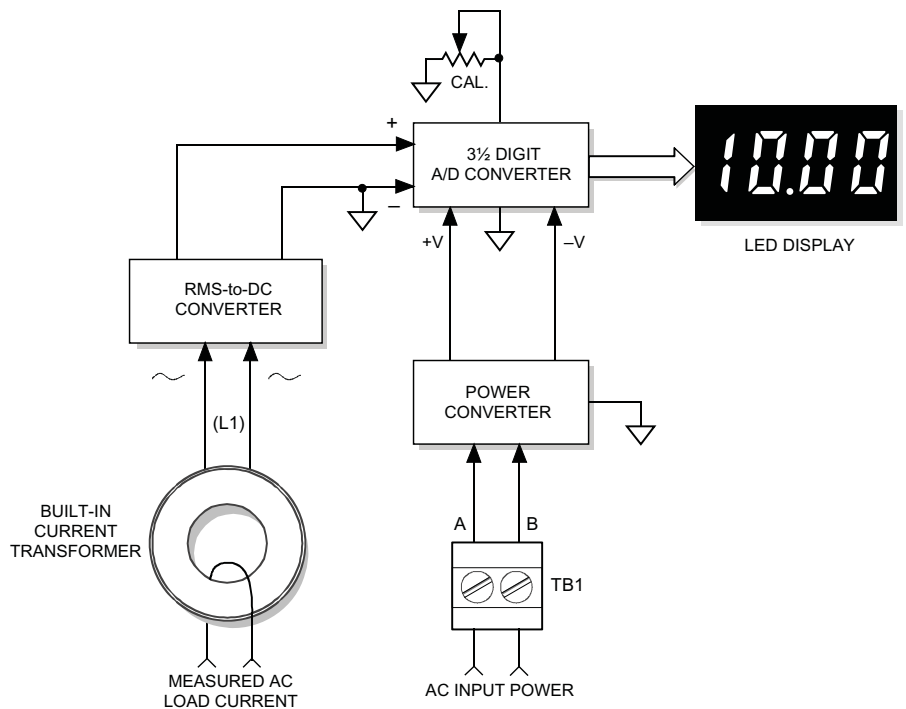

### Performance/Functional Specifications

Typical at T<sub>A</sub> = +25°C, unless otherwise noted.

Rated Full-Scale Current ①	Min.	Typ.	Max.	Units
ACA-20RM-0-ACX-RL	–	–	199.9	mA
ACA-20RM-1-ACX-RL	–	–	1.999	A
ACA-20RM-2-ACX-RL	–	–	19.99	A
ACA-20RM-4-ACX-RL	–	–	50.0	A
ACA-20RM-5-ACX-RL	–	–	30.0	A
Overcurrent Rating ②	1.5 x Rated Full-Scale Current			
<b>Performance</b>				
Sampling Rate	2.5 Samples per second			
Accuracy ③	±0.4%FS ±3 Counts with 60Hz Sine-Wave Input			
Measurement Type	RMS Responding, Crest Factors of 1-5			
Temperature Drift (0 to 60 °C)	–	±0.2	±0.4	Cnts/°C
Zero-Current Reading (within 30 sec.)	–001	000	001	Cnts
Dielectric Withstanding Voltage	2000	–	–	Vdc
<b>Power Supply Voltage</b>				
ACA-20RM-X-AC3-RL	85	120	140	Vac/47-63Hz
ACA-20RM-X-AC4-RL	170	220	264	Vac/47-63Hz
<b>Power Supply Current ④</b>				
ACA-20RM-X-AC3-XX	–	30	50	mA/47-63Hz
ACA-20RM-X-AC4-XX	–	30	50	mA/47-63Hz
<b>Power Supply Terminal Block</b>				
Wire Size	16-22AWG, Solid and stranded			
Insulation Strip Length	0.250 inches			
Screw Tightening Torque	2.2 lb-in (0.25 N-m) ±20%			
Rated Voltage	310Vac			
<b>Display</b>				
Display Type and Size	3½ Digit Red LED, 0.37"/9.4mm High			
Overrange Indication	"1____"			
Decimal Point	Fixed, model dependent (see full-scale input Current)			
<b>Physical/Environmental</b>				
Operating Temperature	0	–	+60	°C
Storage Temperature	–40	–	+75	°C
Humidity	–40	–	+95	%
Dimensions (non-condensing)	Model dependent, see page 3 & 4			
<b>Weight</b>				
ACA-20RM-0,1,2-XXX-XX	1.1 ounces (31 grams) nominal			
ACA-20RM-4-XXX-XX	2.1 ounces (60 grams) nominal			
ACA-20RM-5-XXX-XX	1.5 ounces (43 grams) nominal			

- ① Specified full-scale currents are those passing through the ammeter's built-in current transformer's primary load-circuit. See Notes 2 and 3 below for additional model-specific information.
- ② The overcurrent rating of 1.5 x the rated full-scale current is a continuous rating and applies to the current passing through the built in current transformer only, it does not apply to any external circuit-wiring or external loads. Accuracy is guaranteed up to the rated current level.
- ③ Specified accuracy applies to inputs with crest factors (CF) up to 2.0, where CF = V<sub>peak</sub>/V<sub>rms</sub>. Crest factors of 2 to 5 introduce an additional error of ±3% of full scale. Ammeters are calibrated with a near full-scale 60Hz sine-wave current flowing through the ammeter's built-in CT.
- ④ All specified maximum power supply currents are steady state; larger surge currents can occur at initial application of line power.

### Ordering Information

#### ACA-20RM- 1 - AC3 - RL - C



#### Input Range:

- 0 = 199.9mA
- 1 = 1.999A
- 2 = 19.99A
- 4 = 50.0A (with split-core flying-lead CT)
- 5 = 30.0A (with flying-lead CT)

#### Power:

- AC3 = 85-140Vac@50/60Hz
- AC4 = 170-264Vac@50/60Hz

#### Accessories:

- DMS-20-CP Panel Cutout Punch

### TECHNICAL NOTES

**IMPORTANT!** To ensure safe and reliable operation, ACA-20RM ammeters must be installed and serviced by qualified technical personnel after reading this data sheet in its entirety. Contact DATEL if there is any doubt regarding their installation or operation.

1. **Measurement Type:** ACA-20RM ac ammeters employ true-rms input circuitry to measure the stepped-down output of their on-board current transformers (CT). Stated accuracy is measured using a sine-wave input at, or close to, the specified full scale input, at a nominal line frequency of 60HZ.
2. **Calibration:** Periodic recalibration of ACA-20RM ammeters is not required under normal indoor environments. If user calibration is deemed necessary, it must be performed by qualified technical personnel since potentially lethal voltages and currents are applied to the ACA-20RM during the calibration process.

Calibration is performed with approximately 95% of the specified full-scale current flowing through the ammeter's built-in CT. A fully insulated, non-metallic adjusting tool must be used to adjust the calibration potentiometer, located on the back of the ammeter (see Mechanical Specifications section).

The calibration potentiometer has approximately ¾ of a turn of rotation; do not force its adjustment screw past the end stops. Contact MPS if additional information is required regarding calibration, setup, or any other technical issue pertaining to ACA-20RM ac ammeters.

**3. Wire Gauges and Fusing:** Wires specified in the Functional Specifications section must be used for making connections to ACA-20RM series ammeters. All power-supply and load wiring must be rated for the supply voltages and currents they will conduct and must comply with any code or application-mandated requirements pertaining to the user's specific installation.

ACA-20RM ammeters are not internally fused. Terminal block TB1 is to be used only for powering the ammeter's internal circuitry; it must not be used to supply power to external loads. The supply wires feeding these ammeters must be fused with a 0.25A/250V time delay/time lag fuse, in accordance with applicable regulatory codes.

Wire insulation must be stripped to within ±10% of the stated dimensions, and wires should be inserted into TB1 such that their insulation is not pinched by the screw terminal.

**4. AC Supply Polarity and Grounding:** The two supply inputs, TB1 'A' and 'B', on ACA-20RM ammeters are not polarity sensitive, that is, they have no 'AC LO' or 'AC HI' designations. Also, ac-powered ACA-20RM ammeters do not include or require a connection to earth/chassis ground.

**5. Connector Torque Ratings:** Be sure to tighten TB1's screw-terminals to 3.6 pound-inches (0.4Nm). Proper tightening will ensure reliable long-term operation.

**6. Isolation:** The on-board CT (L1) provides a minimum of 2000Vdc isolation between the current-carrying load conductor passing through its opening and the ammeter's power source that's connected to TB1. Of course, this isolation rating applies only to applications where the load wire does not connect directly or indirectly to TB1-A or TB1-B (i.e., where two different ac supplies are involved).

**7. Split-Core CT (Clamp-on) Models:** 50A models feature a split-core current transformer that can be clamped around a current-carrying load conductor without having to disconnect or remove power from the load's power source. This live-connection capability can only be used if the load's power source is isolated (see technical note 6) from the ammeter's own power source that's connected to TB1. The ammeter's ac power supply must always be deenergized before making connections to TB1. Refer to the 'Panel Installation' section of this data sheet for additional information.

### WIRING DIAGRAMS

First pass and carefully dress one external load wire through L1, then connect the AC supply and load wires to TB1 as shown. Ensure all wires are stripped and properly tightened. For accurate operation, make only



Figure 2. Connections for pc-board mounted CT's

one pass with load wire through the on-board CT (only one primary turn). For split-core CT models, make sure to fully engage the CT's Locking mechanism



Figure 3. Connection for flying lead CT's

**PANEL INSTALLATIONS**

All connections to ACA-20RM Series ammeters must be made after the ammeter is securely attached to its panel and with all associated load and supply voltages de-energized (off). However, using extreme caution and observing all safety measures applicable to the user's installation, 50A split-core CT models can be connected to energized current-carrying load conductors, but connections to TB1 must always be made with the ammeter's power source off.

Care should be exercised when passing the load-carrying conductor through the meter's built-in CT—particularly when larger conductors are used. The installed wire-positions should be such that minimal mechanical forces are applied to the built-in CT, TB1, or to the ammeter itself. In high-vibration environments, it is strongly recommended that adequate strain reliefs be used for all load and supply wiring.

Using Figure 4 as a guide, carefully insert the bezel/color filter assembly into the panel opening. From the rear of the panel, install the four round plastic standoffs over the bezel's threaded studs. Install the pc-board assembly; then attach and securely tighten each of the four hex nuts to 15-20 ozf-in (0.106 to 0.140 N-m). Use only the factory-supplied hardware as the use of substitute hardware could result in an unsafe installation and/or adversely affect the reliability of the ammeter itself.

The recommended range of panel thickness that can be used with the supplied hardware is 0.040 inches (1.0mm) to 0.125 inches (3.2mm). Panel thickness outside of this range will require additional user-supplied hardware and/or modifications.



Figure 4. Panel Installation

**BEZEL AND PANEL CUTOUT**

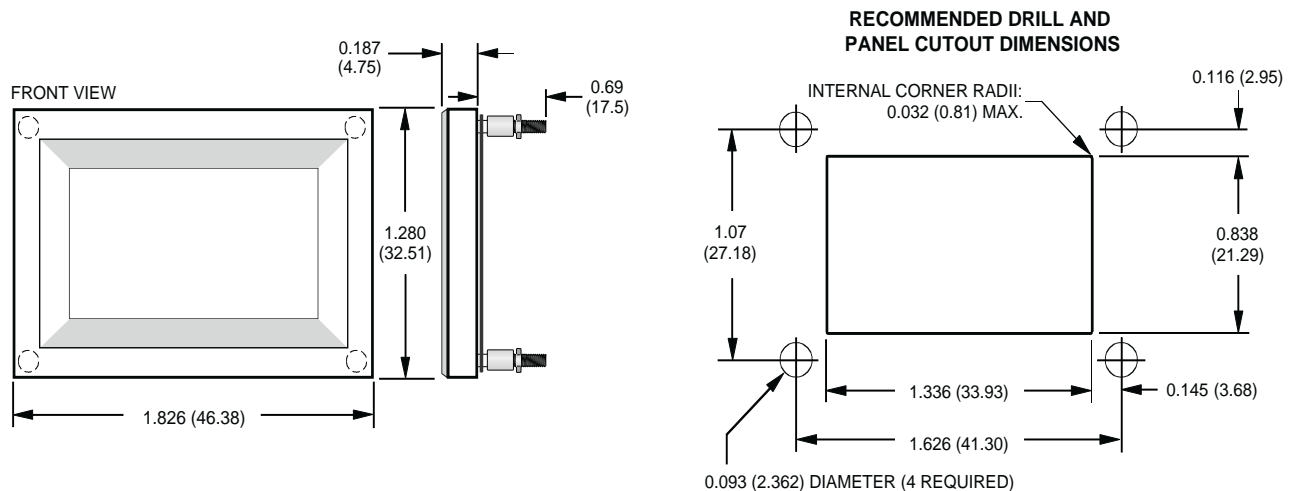

**MECHANICAL SPECIFICATIONS**

LEADED SPLIT-CORE CT MODELS  
FRONT VIEW

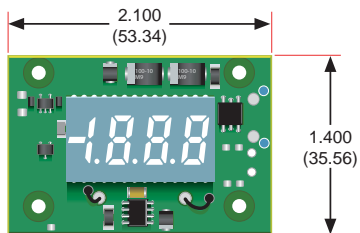

BACK VIEW



Lead Length  
5.0 (127.0) min.



SIDE VIEW



LEADED CT MODELS  
FRONT VIEW

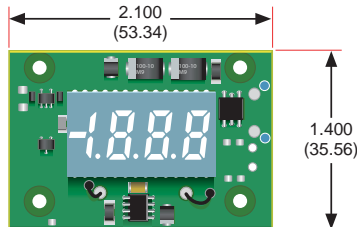

BACK VIEW



Lead Length  
2.0 (50.5) min.



SIDE VIEW

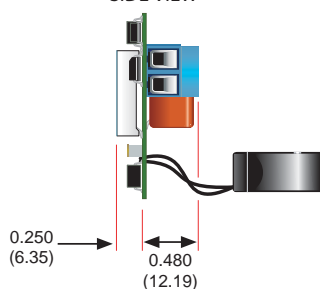

PC-BOARD MOUNTED CT MODELS  
FRONT VIEW

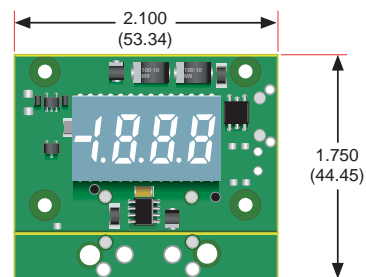

BACK VIEW

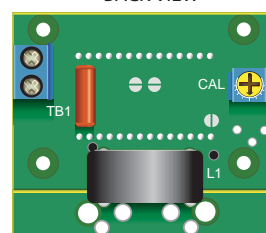

SIDE VIEW

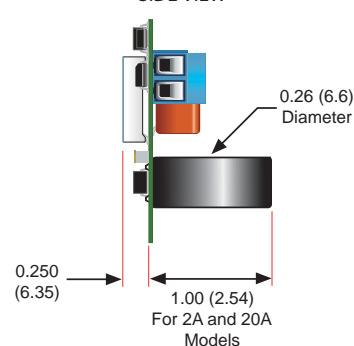

MECHANICAL DIMENSIONS: Inches (mm)  
TOLERANCES: 2 PL DEC ±0.02 (±0.51)  
3 PL DEC ±0.010 (±0.254)



Компания «ЭлектроПласт» предлагает заключение долгосрочных отношений при поставках импортных электронных компонентов на взаимовыгодных условиях!

Наши преимущества:

- Оперативные поставки широкого спектра электронных компонентов отечественного и импортного производства напрямую от производителей и с крупнейших мировых складов;
- Поставка более 17-ти миллионов наименований электронных компонентов;
- Поставка сложных, дефицитных, либо снятых с производства позиций;
- Оперативные сроки поставки под заказ (от 5 рабочих дней);
- Экспресс доставка в любую точку России;
- Техническая поддержка проекта, помощь в подборе аналогов, поставка прототипов;
- Система менеджмента качества сертифицирована по Международному стандарту ISO 9001;
- Лицензия ФСБ на осуществление работ с использованием сведений, составляющих государственную тайну;
- Поставка специализированных компонентов (Xilinx, Altera, Analog Devices, Intersil, Interpoint, Microsemi, Aeroflex, Peregrine, Syfer, Eurofarad, Texas Instrument, Miteq, Cobham, E2V, MA-COM, Hittite, Mini-Circuits, General Dynamics и др.);

Помимо этого, одним из направлений компании «ЭлектроПласт» является направление «Источники питания». Мы предлагаем Вам помощь Конструкторского отдела:

- Подбор оптимального решения, техническое обоснование при выборе компонента;
- Подбор аналогов;
- Консультации по применению компонента;
- Поставка образцов и прототипов;
- Техническая поддержка проекта;
- Защита от снятия компонента с производства.



#### Как с нами связаться

**Телефон:** 8 (812) 309 58 32 (многоканальный)

**Факс:** 8 (812) 320-02-42

**Электронная почта:** [org@eplast1.ru](mailto:org@eplast1.ru)

**Адрес:** 198099, г. Санкт-Петербург, ул. Калинина, дом 2, корпус 4, литера А.