

## Surface Mount ESD Capability Rectifiers

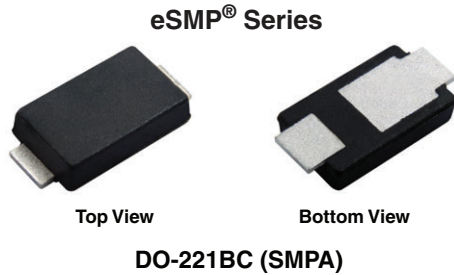

**RoHS**  
COMPLIANT  
HALOGEN  
**FREE**

### FEATURES

- Very low profile - typical height of 0.95 mm
- Ideal for automated placement
- Oxide planar chip junction
- Low forward voltage drop, low leakage current
- ESD capability
- Meets MSL level 1, per J-STD-020, LF maximum peak of 260 °C
- Not recommended for PCB bottom side wave mounting
- AEC-Q101 qualified
- Material categorization: for definitions of compliance please see [www.vishay.com/doc?99912](http://www.vishay.com/doc?99912)

PRIMARY CHARACTERISTICS	
$I_{F(AV)}$	2.0 A
$V_{RRM}$	100 V, 200 V, 400 V, 600 V
$I_{FSM}$	32 A
$V_F$ at $I_F = 2.0$ A ( $T_A = 125$ °C)	0.92 V
$I_R$	5 $\mu$ A
$T_J$ max.	175 °C
Package	DO-221BC (SMPA)
Diode variations	Single die

### TYPICAL APPLICATIONS

General purpose, power line polarity protection, in both consumer and automotive applications.

### MECHANICAL DATA

**Case:** DO-221BC (SMPA)

Molding compound meets UL 94 V-0 flammability rating  
Base P/N-M3 - halogen-free, RoHS-compliant, and commercial grade

Base P/NHM3 - halogen-free, RoHS-compliant, and AEC-Q101 qualified

**Terminals:** Matte tin plated leads, solderable per J-STD-002 and JESD 22-B102

M3 suffix meets JESD 201 class 2 whisker test, HM3 suffix meets JESD 201 class 2 whisker test

**Polarity:** Color band denotes the cathode end

MAXIMUM RATINGS ( $T_A = 25$ °C unless otherwise noted)						
PARAMETER	SYMBOL	SE20PAB	SE20PAD	SE20PAG	SE20PAJ	UNIT
Device marking code		20B	20D	20G	20J	
Maximum repetitive peak reverse voltage	$V_{RRM}$	100	200	400	600	V
Maximum DC forward current	$I_F^{(1)}$	2.0				A
	$I_F^{(2)}$	1.4				
Peak forward surge current 10 ms single half sine-wave superimposed on rated load	$I_{FSM}$	32				A
Operating junction and storage temperature range	$T_J, T_{STG}$	-55 to +175				°C

### Notes

(1) Mounted on 10 mm x 10 mm pad areas, 2 oz. FR4 PCB

(2) Free air, mounted on recommended copper pad area



<b>ELECTRICAL CHARACTERISTICS</b> ( $T_A = 25\text{ }^\circ\text{C}$ unless otherwise noted)						
PARAMETER	TEST CONDITIONS		SYMBOL	TYP.	MAX.	UNIT
Instantaneous forward voltage	$I_F = 1.0\text{ A}$	$T_A = 25\text{ }^\circ\text{C}$	$V_F^{(1)}$	0.93	-	V
	$I_F = 2.0\text{ A}$			1.00	1.10	
	$I_F = 1.0\text{ A}$	$T_A = 125\text{ }^\circ\text{C}$		0.83	-	
	$I_F = 2.0\text{ A}$			0.92	1.00	
Reverse current	Rated $V_R$	$T_A = 25\text{ }^\circ\text{C}$	$I_R^{(2)}$	-	5	$\mu\text{A}$
		$T_A = 125\text{ }^\circ\text{C}$		7	100	
Typical reverse recovery time	$I_F = 0.5\text{ A}$ , $I_R = 1.0\text{ A}$ , $I_{rr} = 0.25\text{ A}$		$t_{rr}$	1.3	-	$\mu\text{s}$
Typical junction capacitance	4.0 V, 1 MHz		$C_J$	13	-	pF

**Notes**

- (1) Pulse test: 300  $\mu\text{s}$  pulse width, 1 % duty cycle  
(2) Pulse test: Pulse width  $\leq 40\text{ ms}$

<b>THERMAL CHARACTERISTICS</b> ( $T_A = 25\text{ }^\circ\text{C}$ unless otherwise noted)						
PARAMETER	SYMBOL	SE20PAB	SE20PAD	SE20PAG	SE20PAJ	UNIT
Typical thermal resistance	$R_{\theta JA}^{(1)}$	120				$^\circ\text{C/W}$
	$R_{\theta JM}^{(2)}$	9				

**Notes**

- (1) Free air, mounted on recommended PCB, 2 oz. pad area; thermal resistance  $R_{\theta JA}$  - junction to ambient  
(2) Mounted on 10 mm x 10 mm pad areas, 2 oz. FR4 PCB;  $R_{\theta JM}$  - junction to mount

<b>IMMUNITY TO ELECTRICAL STATIC DISCHARGE TO THE FOLLOWING STANDARDS</b> ( $T_A = 25\text{ }^\circ\text{C}$ unless otherwise noted)					
STANDARD	TEST TYPE	TEST CONDITIONS	SYMBOL	CLASS	VALUE
AEC-Q101-001	Human body model (contact mode)	$C = 100\text{ pF}$ , $R = 1.5\text{ k}\Omega$	$V_C$	H3B	$> 8\text{ kV}$

<b>ORDERING INFORMATION</b> (Example)				
PREFERRED P/N	UNIT WEIGHT (g)	PREFERRED PACKAGE CODE	BASE QUANTITY	DELIVERY MODE
SE20PAJ-M3/I	0.033	I	14 000	13" diameter plastic tape and reel
SE20PAJHM3/I <sup>(1)</sup>	0.033	I	14 000	13" diameter plastic tape and reel

**Note**

- (1) AEC-Q101 qualified



RATINGS AND CHARACTERISTICS CURVES (T<sub>A</sub> = 25 °C unless otherwise noted)

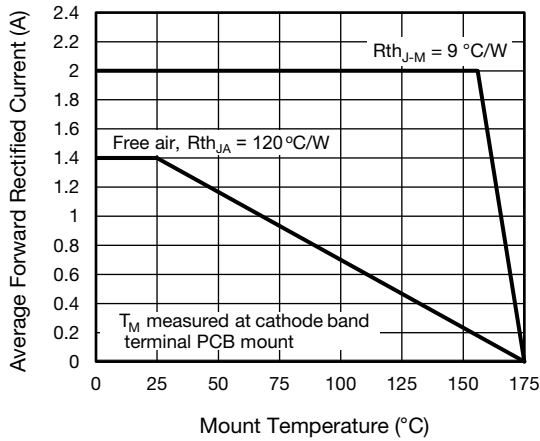

Fig. 1 - Maximum Forward Current Derating Curve

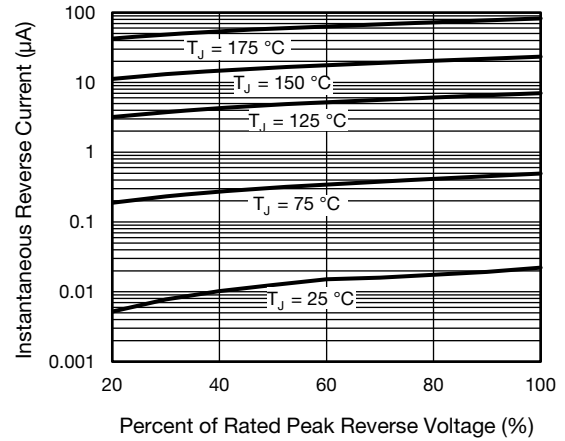

Fig. 4 - Typical Reverse Leakage Characteristics

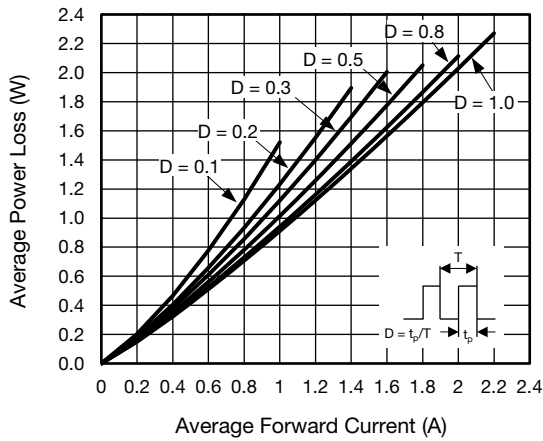

Fig. 2 - Forward Power Loss Characteristics

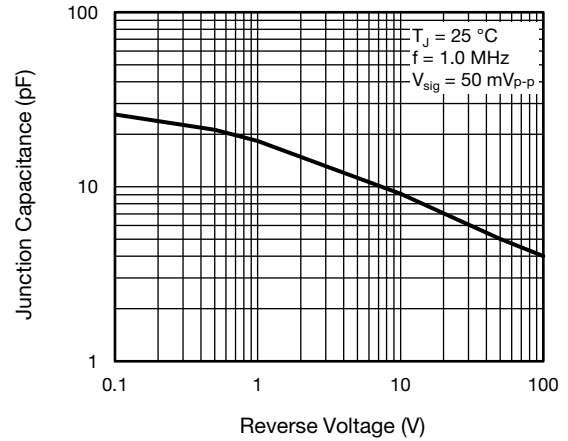

Fig. 5 - Typical Junction Capacitance

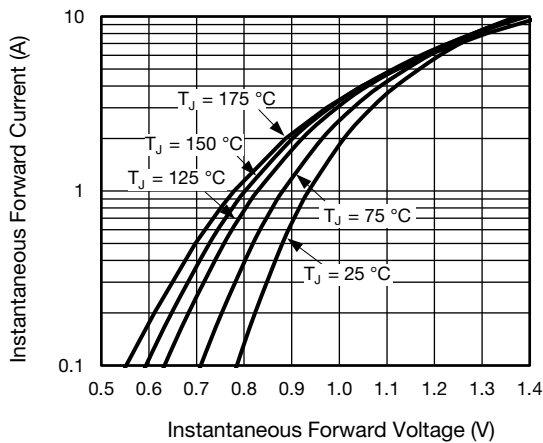

Fig. 3 - Typical Instantaneous Forward Characteristics

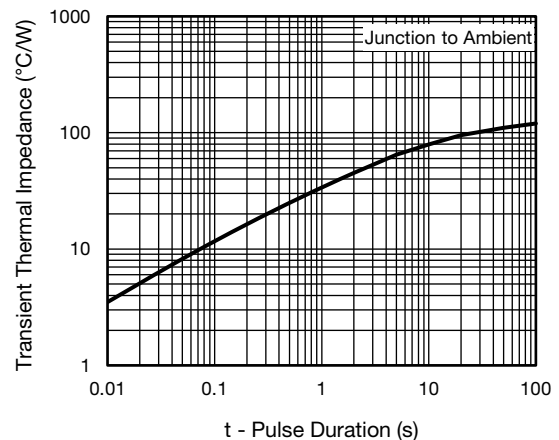
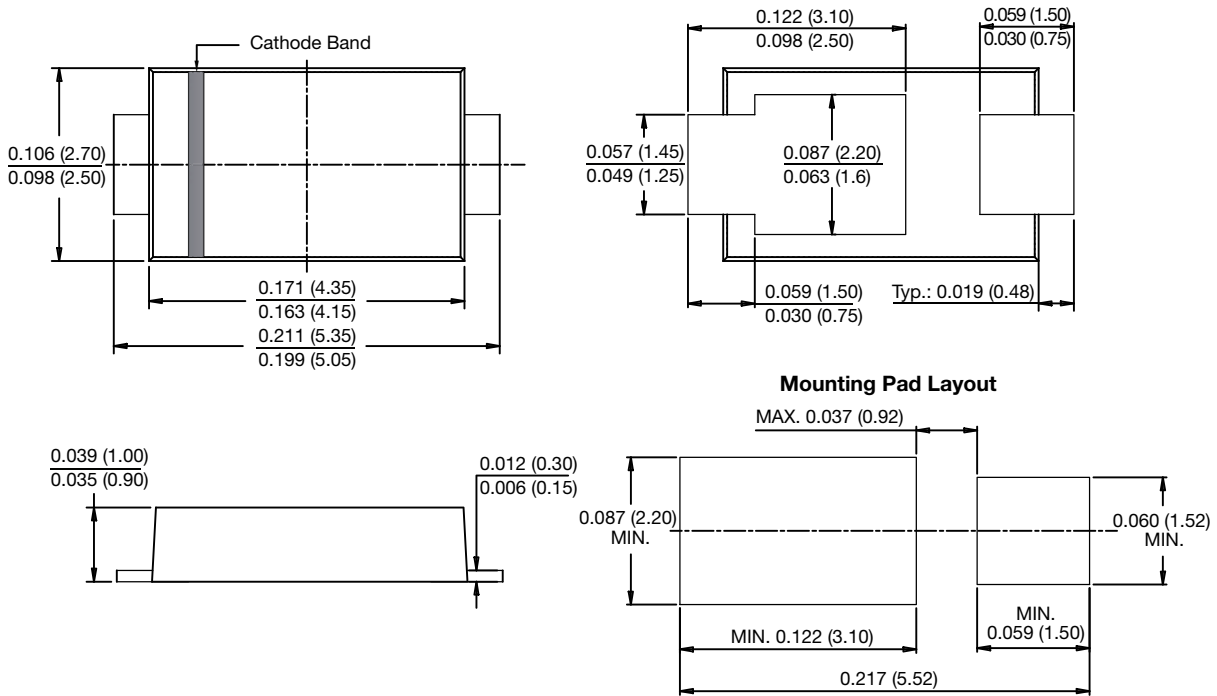

Fig. 6 - Typical Transient Thermal Impedance



## PACKAGE OUTLINE DIMENSIONS in inches (millimeters)

### DO-221BC (SMPA)





## **Disclaimer**

ALL PRODUCT, PRODUCT SPECIFICATIONS AND DATA ARE SUBJECT TO CHANGE WITHOUT NOTICE TO IMPROVE RELIABILITY, FUNCTION OR DESIGN OR OTHERWISE.

Vishay Intertechnology, Inc., its affiliates, agents, and employees, and all persons acting on its or their behalf (collectively, "Vishay"), disclaim any and all liability for any errors, inaccuracies or incompleteness contained in any datasheet or in any other disclosure relating to any product.

Vishay makes no warranty, representation or guarantee regarding the suitability of the products for any particular purpose or the continuing production of any product. To the maximum extent permitted by applicable law, Vishay disclaims (i) any and all liability arising out of the application or use of any product, (ii) any and all liability, including without limitation special, consequential or incidental damages, and (iii) any and all implied warranties, including warranties of fitness for particular purpose, non-infringement and merchantability.

Statements regarding the suitability of products for certain types of applications are based on Vishay's knowledge of typical requirements that are often placed on Vishay products in generic applications. Such statements are not binding statements about the suitability of products for a particular application. It is the customer's responsibility to validate that a particular product with the properties described in the product specification is suitable for use in a particular application. Parameters provided in datasheets and / or specifications may vary in different applications and performance may vary over time. All operating parameters, including typical parameters, must be validated for each customer application by the customer's technical experts. Product specifications do not expand or otherwise modify Vishay's terms and conditions of purchase, including but not limited to the warranty expressed therein.

Except as expressly indicated in writing, Vishay products are not designed for use in medical, life-saving, or life-sustaining applications or for any other application in which the failure of the Vishay product could result in personal injury or death. Customers using or selling Vishay products not expressly indicated for use in such applications do so at their own risk. Please contact authorized Vishay personnel to obtain written terms and conditions regarding products designed for such applications.

No license, express or implied, by estoppel or otherwise, to any intellectual property rights is granted by this document or by any conduct of Vishay. Product names and markings noted herein may be trademarks of their respective owners.



Компания «ЭлектроПласт» предлагает заключение долгосрочных отношений при поставках импортных электронных компонентов на взаимовыгодных условиях!

Наши преимущества:

- Оперативные поставки широкого спектра электронных компонентов отечественного и импортного производства напрямую от производителей и с крупнейших мировых складов;
- Поставка более 17-ти миллионов наименований электронных компонентов;
- Поставка сложных, дефицитных, либо снятых с производства позиций;
- Оперативные сроки поставки под заказ (от 5 рабочих дней);
- Экспресс доставка в любую точку России;
- Техническая поддержка проекта, помощь в подборе аналогов, поставка прототипов;
- Система менеджмента качества сертифицирована по Международному стандарту ISO 9001;
- Лицензия ФСБ на осуществление работ с использованием сведений, составляющих государственную тайну;
- Поставка специализированных компонентов (Xilinx, Altera, Analog Devices, Intersil, Interpoint, Microsemi, Aeroflex, Peregrine, Syfer, Eurofarad, Texas Instrument, Miteq, Cobham, E2V, MA-COM, Hittite, Mini-Circuits, General Dynamics и др.);

Помимо этого, одним из направлений компании «ЭлектроПласт» является направление «Источники питания». Мы предлагаем Вам помощь Конструкторского отдела:

- Подбор оптимального решения, техническое обоснование при выборе компонента;
- Подбор аналогов;
- Консультации по применению компонента;
- Поставка образцов и прототипов;
- Техническая поддержка проекта;
- Защита от снятия компонента с производства.



#### Как с нами связаться

**Телефон:** 8 (812) 309 58 32 (многоканальный)

**Факс:** 8 (812) 320-02-42

**Электронная почта:** [org@eplast1.ru](mailto:org@eplast1.ru)

**Адрес:** 198099, г. Санкт-Петербург, ул. Калинина, дом 2, корпус 4, литера А.